

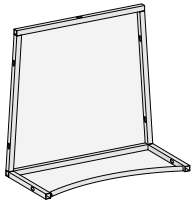

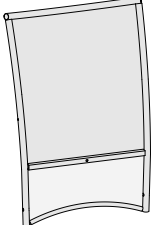
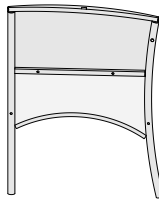
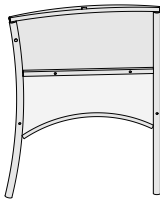
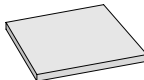

**INSTRUCTION MANUAL/BEDIENUNSANLEITUNG/NOTICE D'UTILISATION/
MANUAL DE INSTRUCCIONES DE USO/MANUALE DI ISTRUZIONI**

- | | | | | |
|---|--|---|--|--|
| <p>! WARNING!
Adults assembly required. During assembly, keep all parts away from children. Check regularly to ensure all fasteners are tight.</p> | <p>! WARNUNG!
Die Montage ist von Erwachsenen durchzuführen. Halten Sie während der Montage alle Teile von Kindern fern. Überprüfen Sie regelmäßig den festen Sitz der Schrauben.</p> | <p>! Attention !
Montage à effectuer par des adultes. Pendant le montage, tenez les éléments éloignés des enfants. Vérifiez régulièrement que toutes les vis soient serrées.</p> | <p>! Atención!
Se requiere que el montaje sea llevado a cabo por un adulto. Durante el montaje, mantenga todas las piezas fuera del alcance de los niños. Verifique regularmente que todos los tornillos estén correctamente apretados.</p> | <p>! avvertimento!
L'assemblaggio deve essere effettuato da adulti. Durante il montaggio mantenere tutti i pezzi lontano dalla portata dei bambini. Controllare regolarmente per assicurarsi che tutte le chiusure siano ben strette.</p> |
|---|--|---|--|--|

PARTS LIST/STÜCKLISTE/PARTS LIST/LISTA DE PIEZAS/LISTA DEI PEZZI
Carton A Karton A Carton A Caja A Contenitore A

A	B	C	D	E1
 4pcs	 4pcs	 4pcs	 4pcs	 47x45x5cm 4pcs
				E2
				 47x45x5cm 4pcs

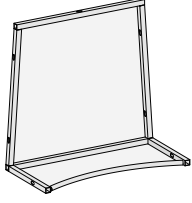
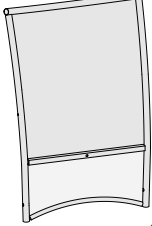
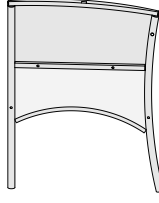
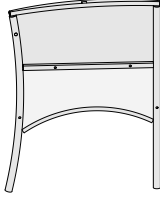
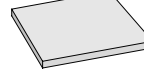





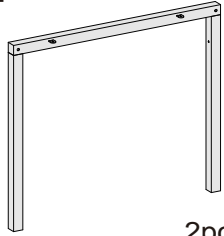
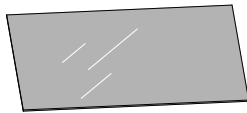

Carton B Karton B Carton B Caja B Contenitore B

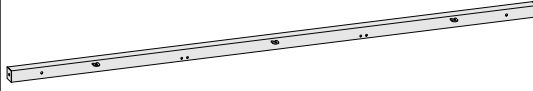
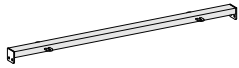
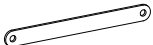
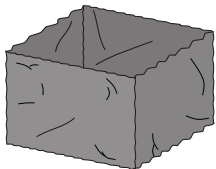
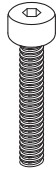
A	B	C	D	E1
 4pcs	 4pcs	 4pcs	 4pcs	 47x45x5cm 4pcs
				E2
				 47x45x5cm 4pcs

Carton C Karton C Carton C Caja C Contenitore C

F	G
 2pcs	 811x584x5mm 3pcs

Carton D Karton D Carton D Caja D Contenitore D

H	I	J	K				
 2pcs	 2pcs	 4pcs	 1pc				
L1	L2	L3	L4	M1	M2	N1	N2
 M8x60 4pcs	 M6x20 16pcs	 M6x35 72pcs	 M6x40 16pcs	 M6 104pcs	 M8 4pcs	 1pc	 1pc

**RETAIN FOR FUTURE REFERENCE
FÜR KÜNFTIGE VERWENDUNG AUFBEWAHREN
A CONSERVER POUR UNE UTILISATION FUTURE
CONSERVAR PARA SER LEÍDO POR CADA NUEVO USUARIO
ANTES DE UTILIZAR EL ARTÍCULO POR PRIMERA VEZ
CONSERVARE PER CONSULTAZIONI FUTURE**



Warning!
Warnung!
Attention !
Atención!
Avvertimento!

Tight all the screws to 60% first then tight to 100%.
 Während der Montage alle Schrauben zuerst 60% anziehen, dann zu 100%.
 Serrez toutes les vis à 60% d'abord puis serrez à 100%.
 Primero apriete los tornillos al 60% y después al 100%.
 Stringere le viti dapprima al 60% e successivamente completamente al 100%.

1

L3 :1pcs x8
 M1:1pcs x8

2

L3 :4pcs x8
 L4 :1pcs x8
 M1:5pcs x8

3

L3 :4pcs x8
 L4 :1pcs x8
 M1:5pcs x8

4

L2 :8pcs
 M1:8pcs

5

L1 :4pcs
 M2:4pcs

6

L2 :8pcs
 M1:8pcs



Warning!
Warnung!
Attention !
Atención!
Avvertimento!

Tight all the screws to 60% first then tight to 100%.
Während der Montage alle Schrauben zuerst 60% anziehen, dann zu 100%.
Serrez toutes les vis à 60% d'abord puis serrez à 100%.
Primero apriete los tornillos al 60% y después al 100%.
Stringere le viti dapprima al 60% e successivamente completamente al 100%.

7

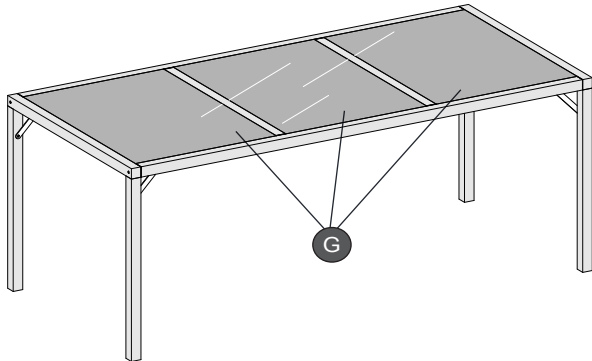

8

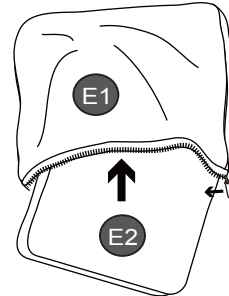

E2 :8pcs
E3 :8pcs

9



10

