

HAITI II (2AL-MaxiRC) RGB-LED



- | | |
|----------------------------------|--------------------------------|
| (DE) Montageanleitung | (IT) Istruzioni di montaggio |
| (PL) Instrukcja montażu | (FR) Notice de montage |
| (NL) Handleiding voor de montage | (RO) Instrucțiuni de asamblare |
| (GB) Assembly instructions | (SK) Montážny návod |
| (TR) Montaj talimatı | (CZ) Montážní návod |
| (RU) Инструкция по монтажу | (HU) Szerelési útmutató |

Service - Servis - Dienstverlening - Servis - Serwis - Сервисная служба - Servizio
 Service - Serviciu - Služby - Szolgáltatás

Name - Nazwa - Naam - Name - Isim - название
 Nome - Nom - Numele - Meno - Jméno - Neve

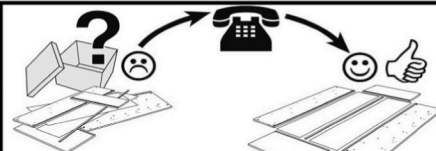

HAITI II (2AL-MaxiRC) RGB-LED



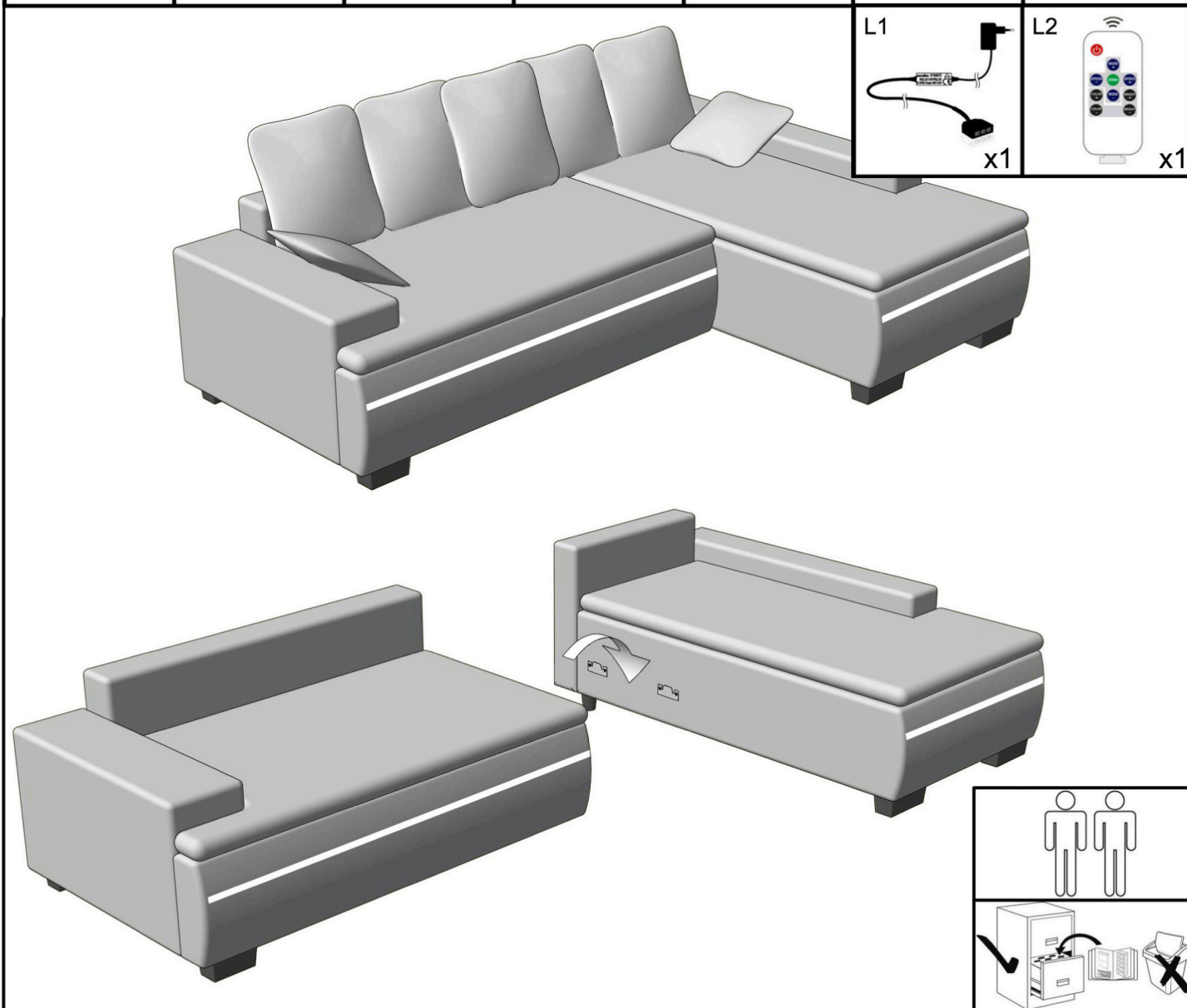

F1 L-280 H-70 x3	F2 L-200 H-70 x2	F3 H-70 x4	S1 M5x50 x14	T1 x14	P1 55x55 x5	P2 45x45 x2
----------------------------	----------------------------	----------------------	------------------------	---------------	-----------------------	-----------------------



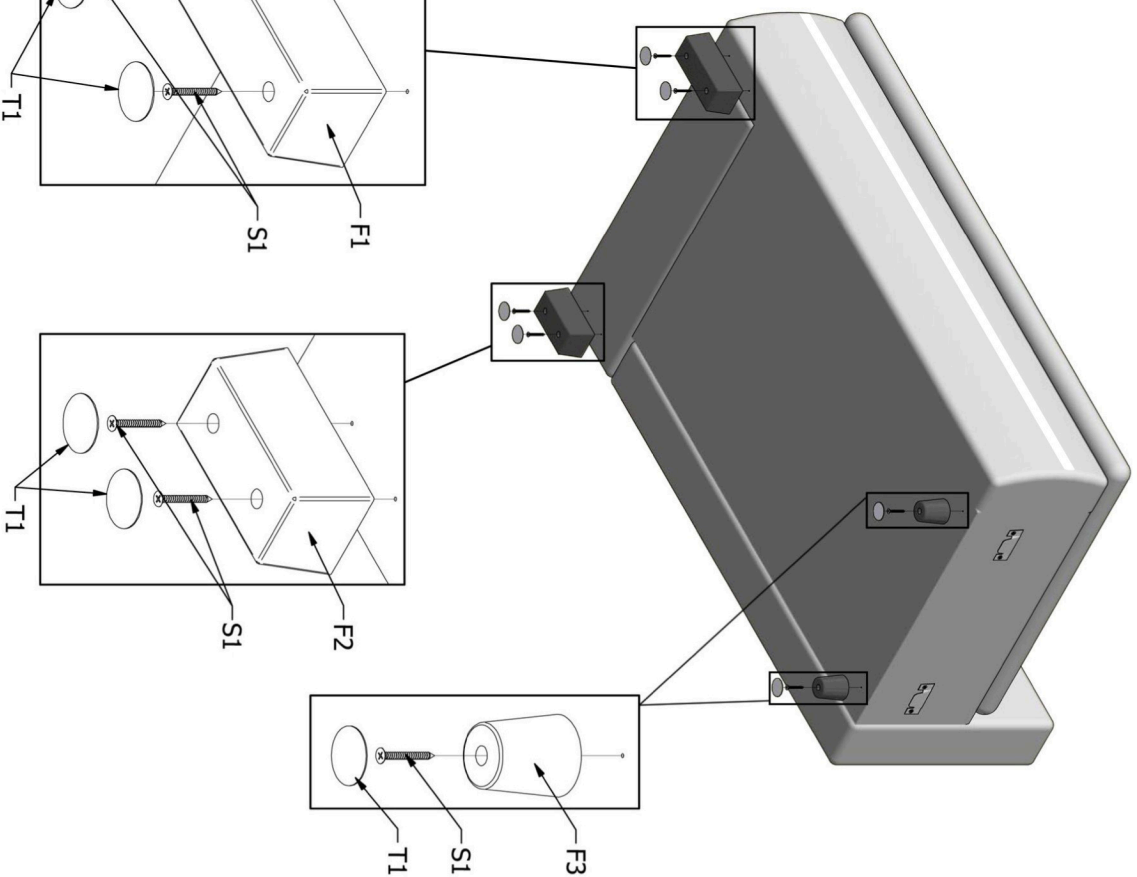

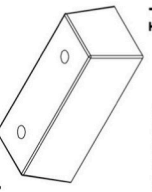
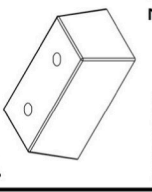

2AL

MaxiRC

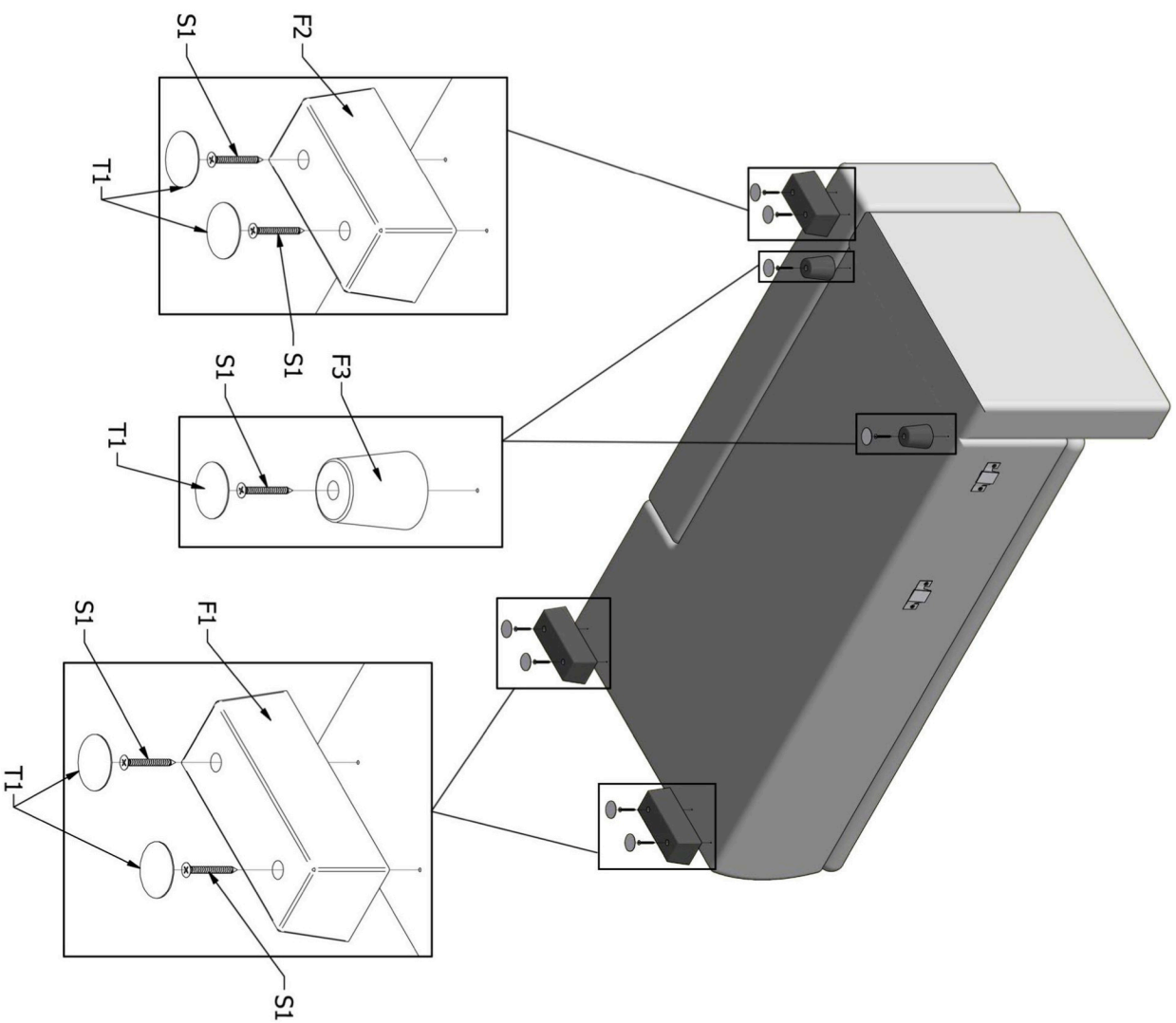

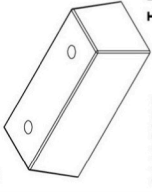
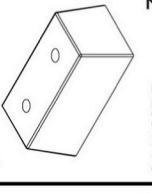
	F1	L-280 H-70	x1
	F2	L-200 H-70	x1
	F3	H-70	x2
	S1	M5x50	x6
	T1		x6



	F1	L-280 H-70	x2
	F2	L-200 H-70	x1
	F3	H-70	x2
	S1	M5x50	x8
	T1		x8

DE Alle elektrischen Komponenten, die in den Möbeln verwendet werden, müssen in den für Elektroschrott vorgesehenen Behälter entsorgt werden.

PL Wszystkie elementy elektryczne zastosowane w meblach należy wyrzucać do pojemników przewidzianych na odpady elektryczne.

NL Alle in meubilair gebruikte elektrische onderdelen moeten worden weggegooid in de daarvoor bestemde containers voor elektrisch afval.

GB All electrical components used in furniture should be disposed of in the containers provided for electrical waste.

TR Mobilyalarda kullanılan tüm elektrikli bileşenler, elektrikli atıklar için sağlanan konteynerlere atılmalıdır.

RU Все электрические компоненты, используемые в мебели, должны быть утилизированы в контейнеры, предусмотренные для электротехнических отходов.

IT Tutti i componenti elettrici utilizzati nei mobili devono essere smaltiti nei contenitori previsti per i rifiuti elettrici.

FR Tous les composants électriques utilisés dans le mobilier doivent être jetés dans les conteneurs prévus pour les déchets électriques.

RO Toate componentele electrice utilizate în mobilier trebuie aruncate în containerele prevăzute pentru deșeurile electrice.

SK Všetky elektrické komponenty použité v nábytku by sa mali likvidovať do kontajnerov určených na elektroodpad.

CZ Všechny elektrické součásti použité v nábytku by měly být likvidovány v kontejnerech určených pro elektroodpad.

HU A bútorokban használt összes elektromos alkatrészt az elektromos hulladékok számára fenntartott konténerekben kell megsemmisíteni.

