

LEANDRO V
8100/2503
2501/8300

- | | | | |
|-----------|--|-----------|---|
| D | MONTAGEANLEITUNG
BEDIENUNGSANLEITUNG | GB | ASSEMBLY INSTRUCTIONS
INSTRUCTION MANUAL |
| NL | HANDLEIDING VOOR DE MONTAGE
GEBRUIKSAANWIJZING | PL | INSTRUKCJA MONTAŻU
INSTRUKCJA OBSŁUGI |
| TR | MONTAJ TALIMATI
KULLANIM KLAVUZU | RU | ИНСТРУКЦИЯ ПО МОНТАЖУ
ИНСТРУКЦИЯ ПО ЭКСПЛУАТАЦИИ |
| RO | INSTRUCȚIUNI DE INSTALARE
INSTRUCȚIUNI DE UTILIZARE | IT | ISTRUZIONI DI MONTAGGIO
MANUALE DI ISTRUZIONI |
| FR | NOTICE DE MONTAGE
MANUEL INSTRUCTIONS | SK | MONTÁŽNY NÁVOD
NÁVOD NA POUŽITIE |
| HU | KÖZGYŰLÉS UTASÍTÁSOK
KEZELÉSI UTASÍTÁS | CZ | MONTÁŽNÍ NÁVOD
NÁVOD K POUŽITÍ |
| SI | NAVODILA ZA MONTAŽO
NAVODILA ZA UPORABO | PT | INSTRUÇÕES DE MONTAGEM
MANUAL DO USUÁRIO |
| ES | INSTRUCCIONES DE MONTAJE
MANUAL DEL USUARIO | HR | UPUTE ZA MONTAŽU
UPUTE ZA UPOTREBU |

F/B

230105

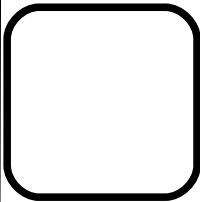
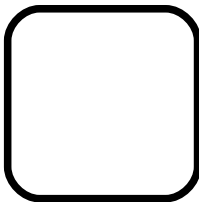

0037

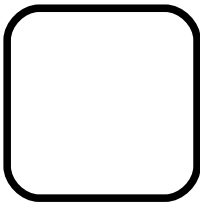
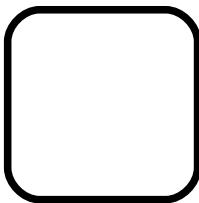
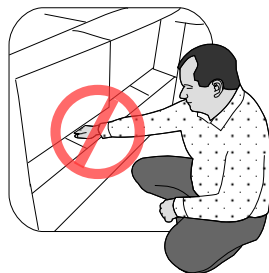
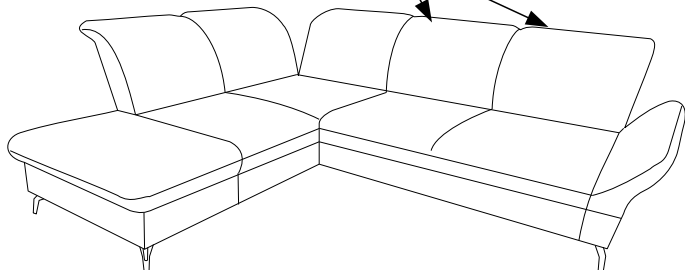
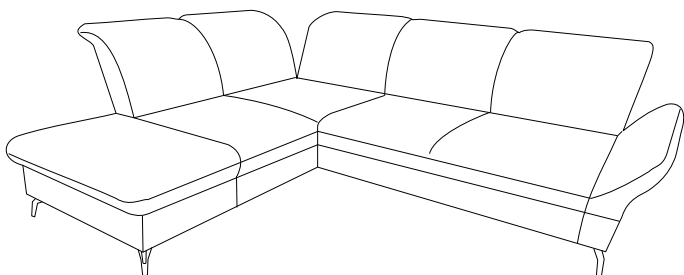
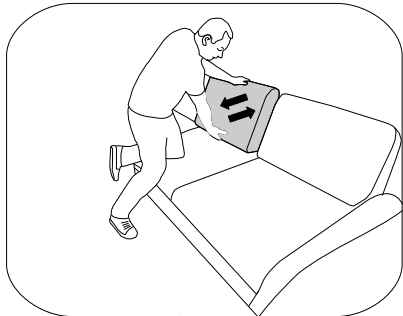

0037

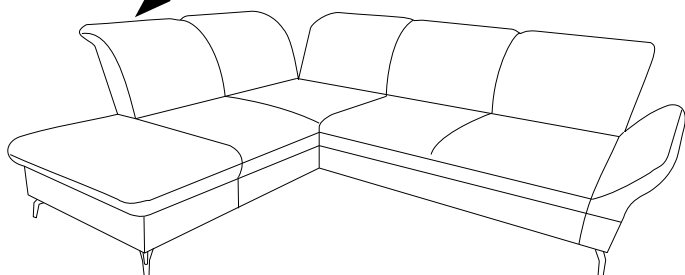
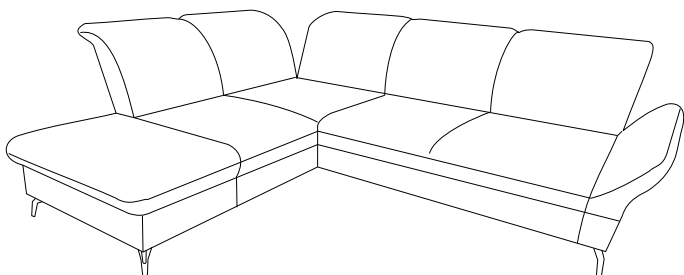
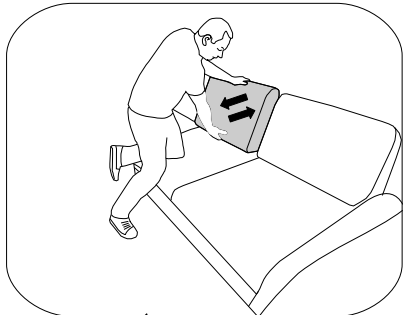

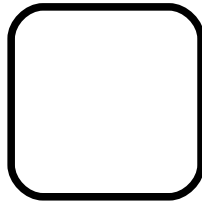
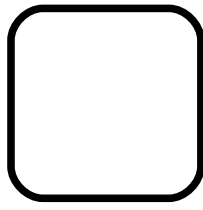

0064

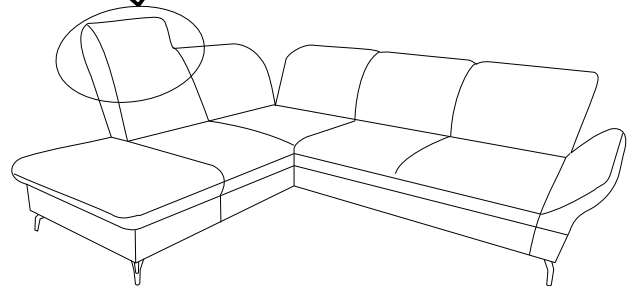
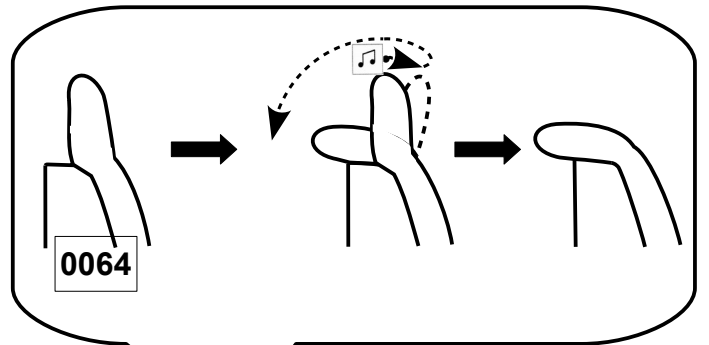
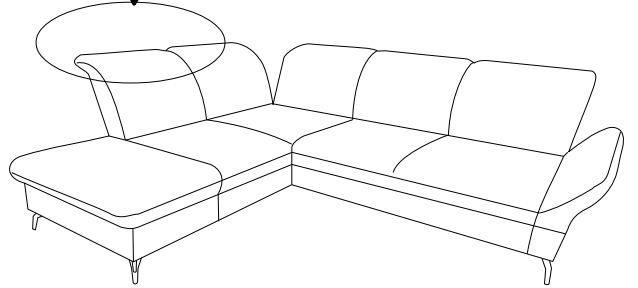
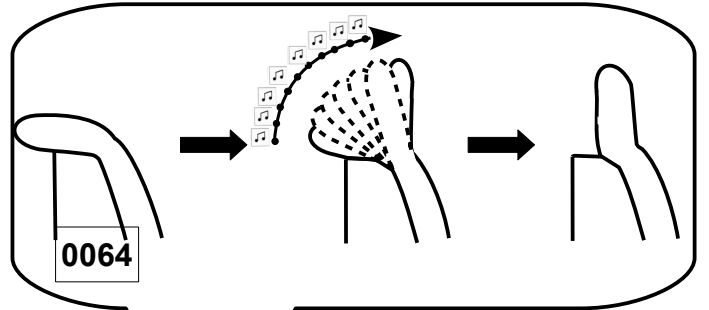
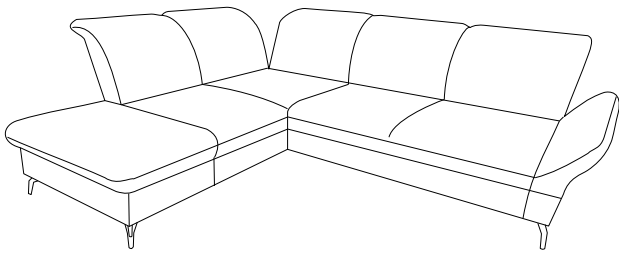

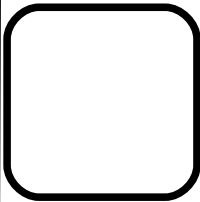
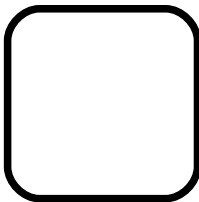

0019

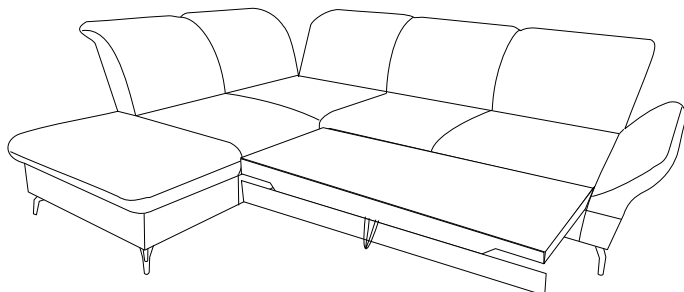
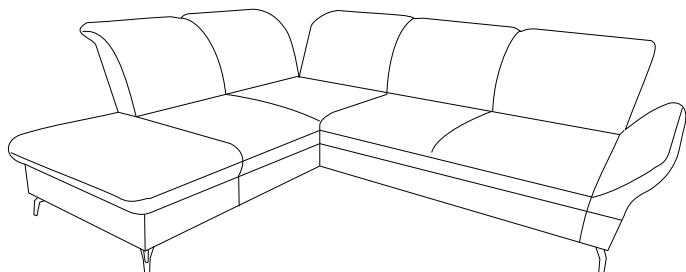

0019

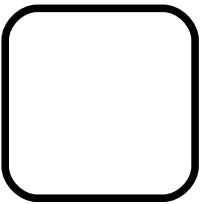
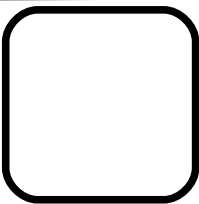

0088

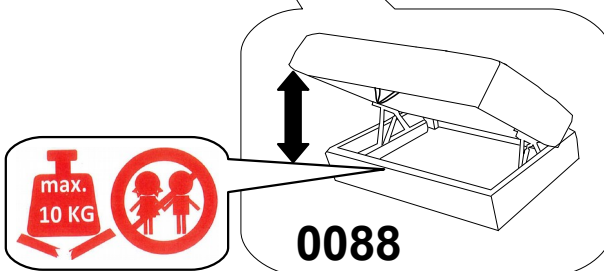
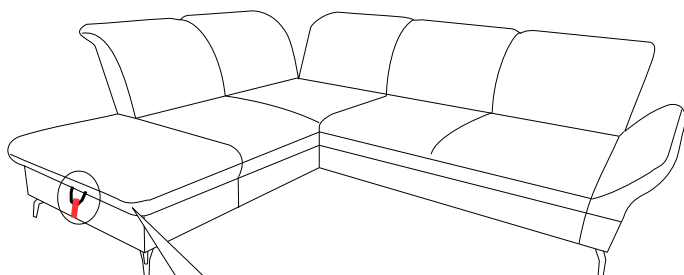
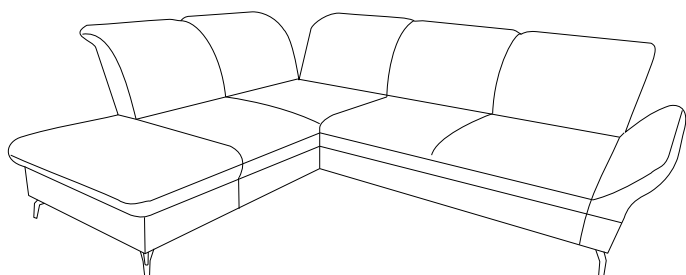
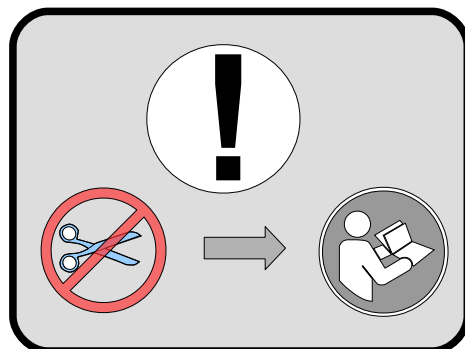

0088

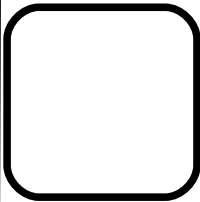
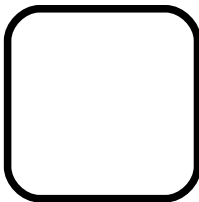

0090

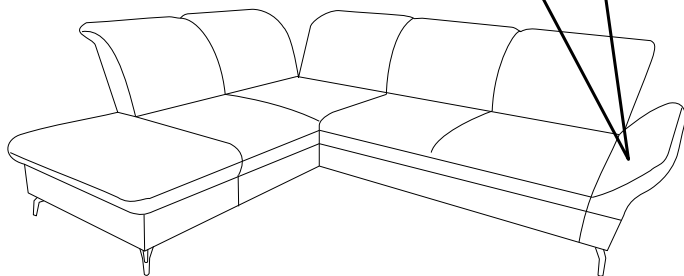
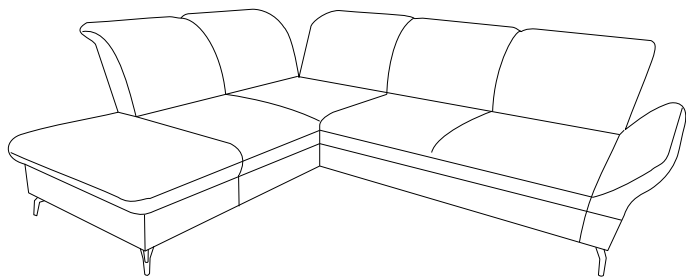
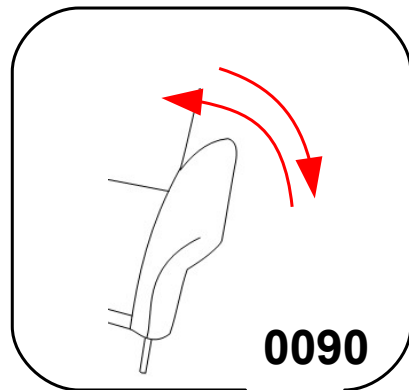

L

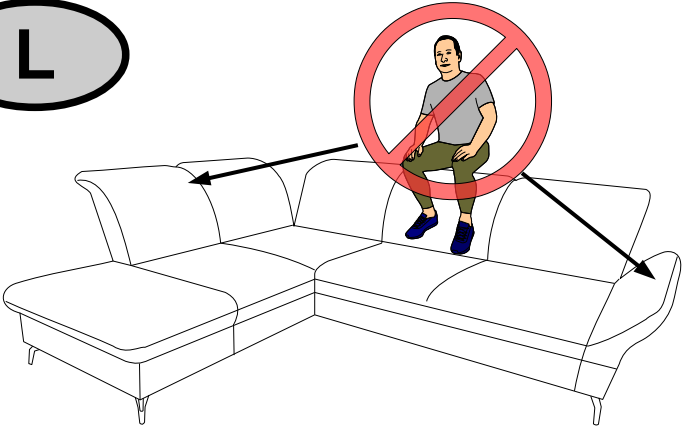

R

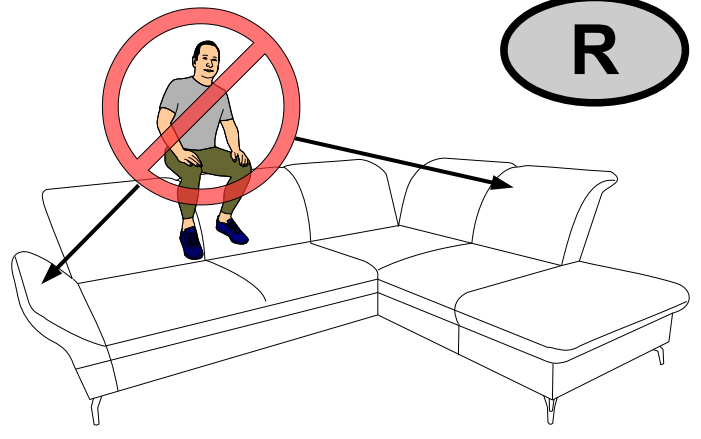

g H- 120 X3	v H- 120 X1	i L- 4 X1	s H- 120 s ₁ X3	q M6*25 [mm] X12
---------------------------	---------------------------	-------------------------	---	--------------------------------

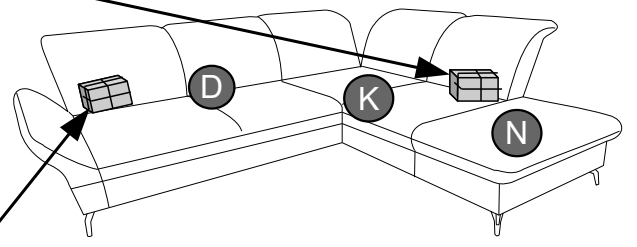
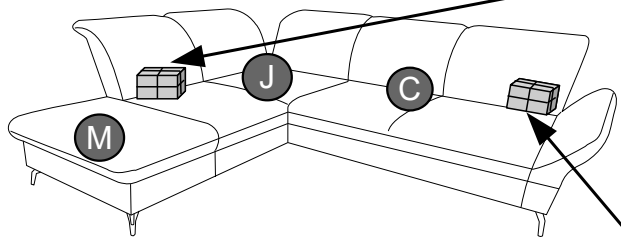

i L- 5 X1	s H- 120 s ₁ X2	q M6*25 X8
-------------------------	---	--------------------------

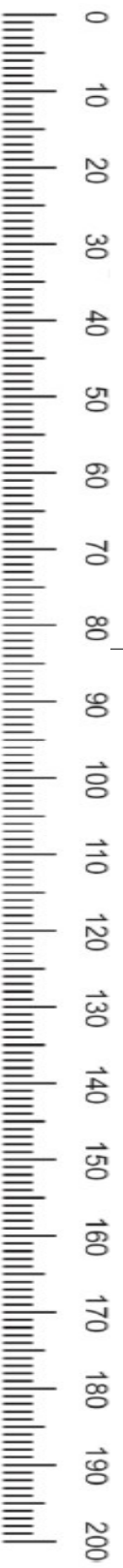
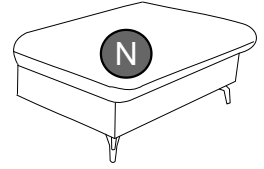
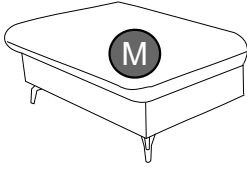
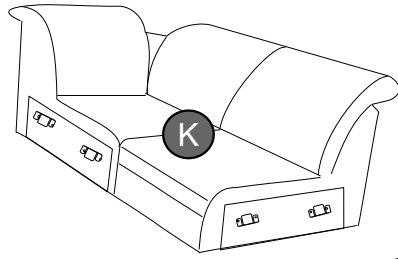
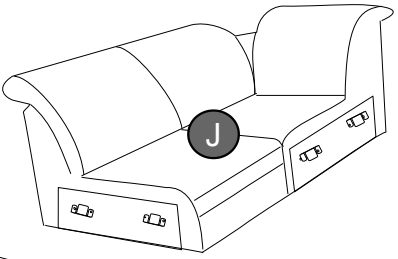
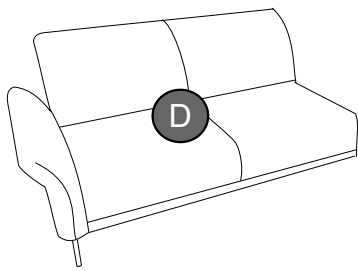
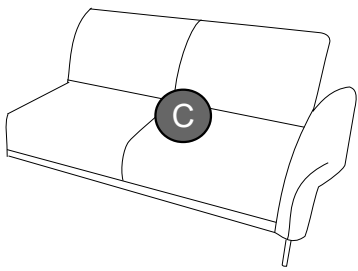

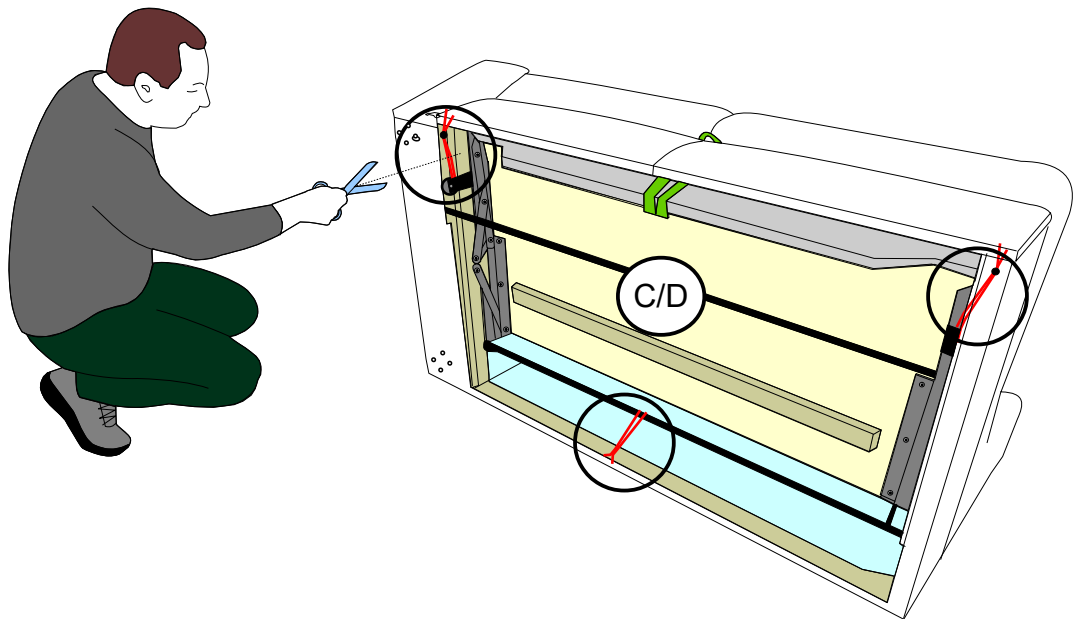
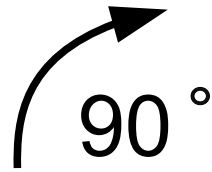
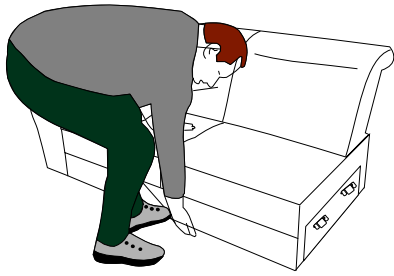

0019

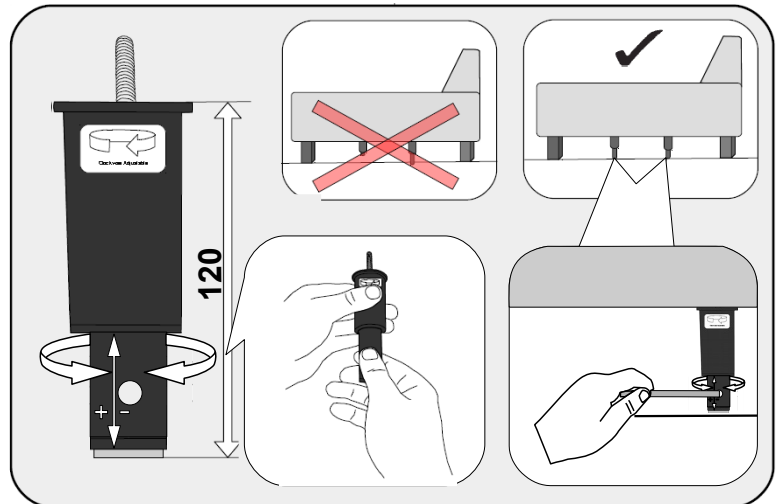
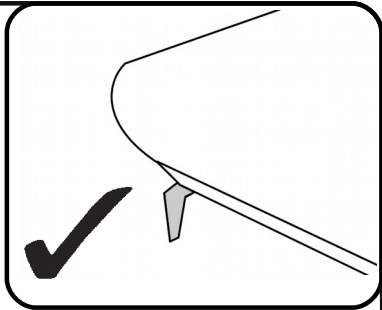
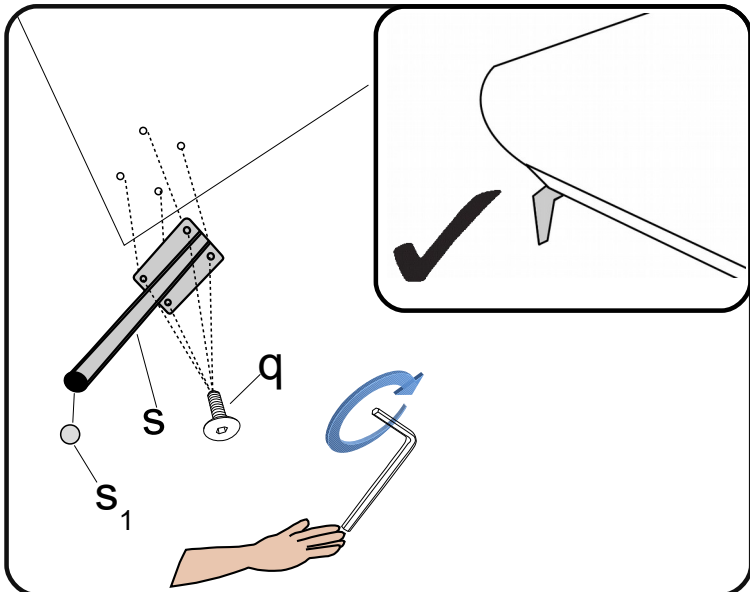
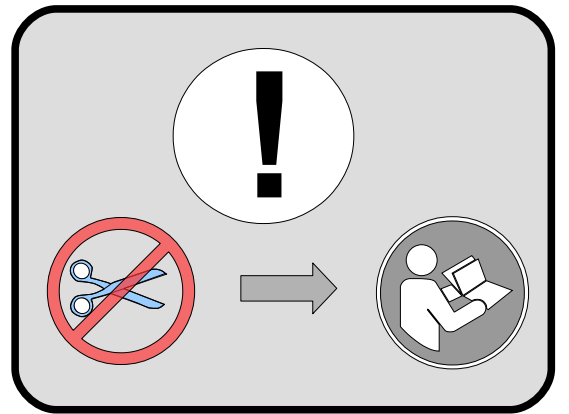
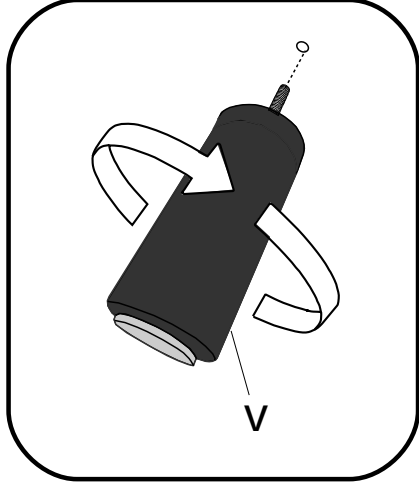
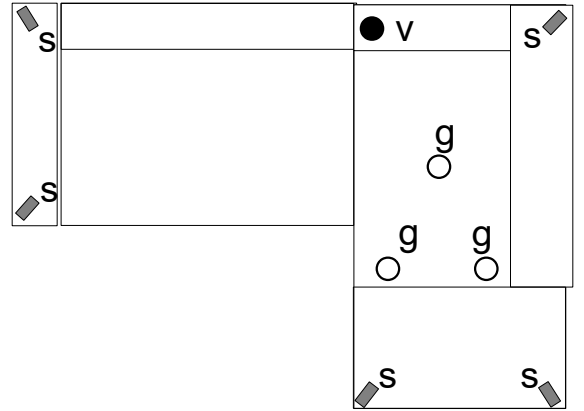
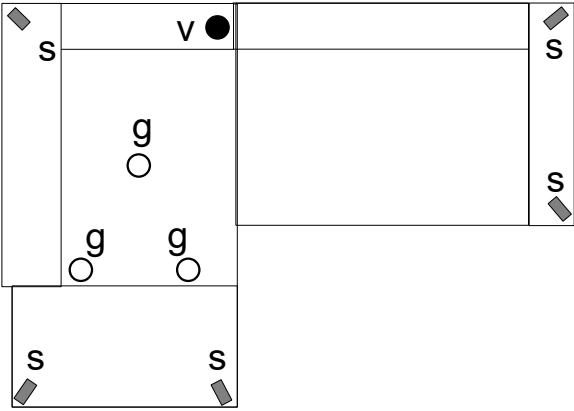
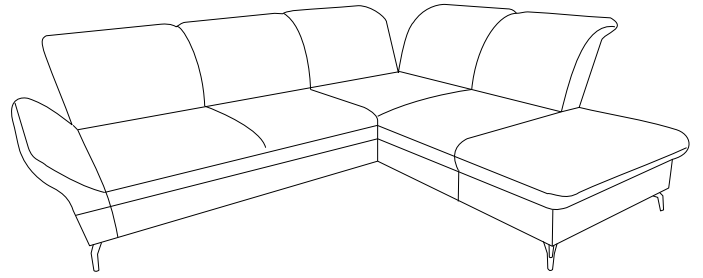
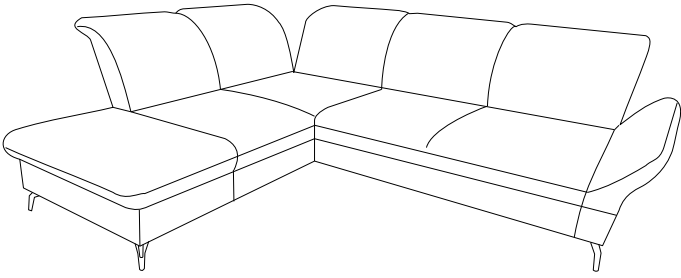
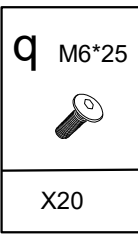
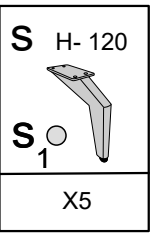
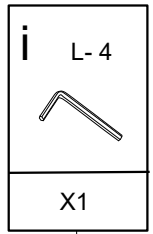
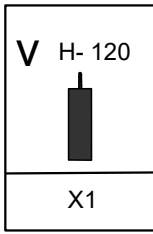
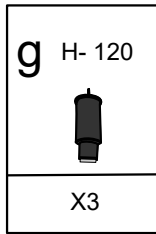

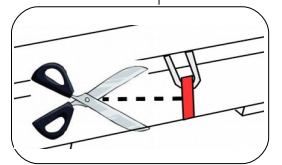
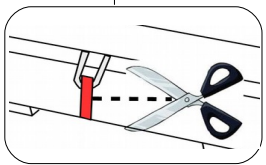
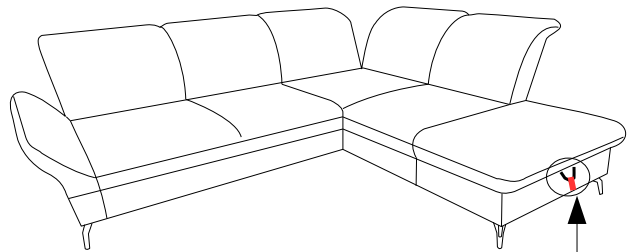
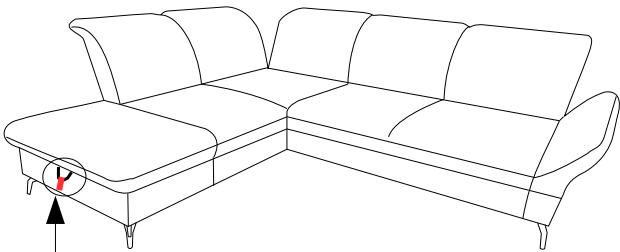
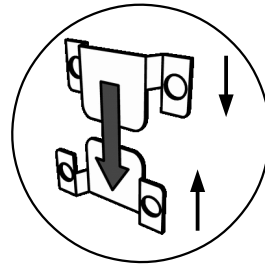
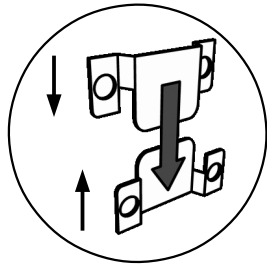
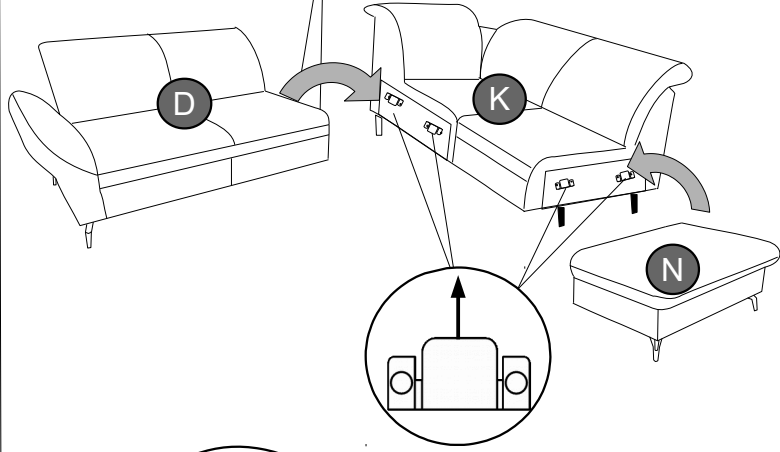
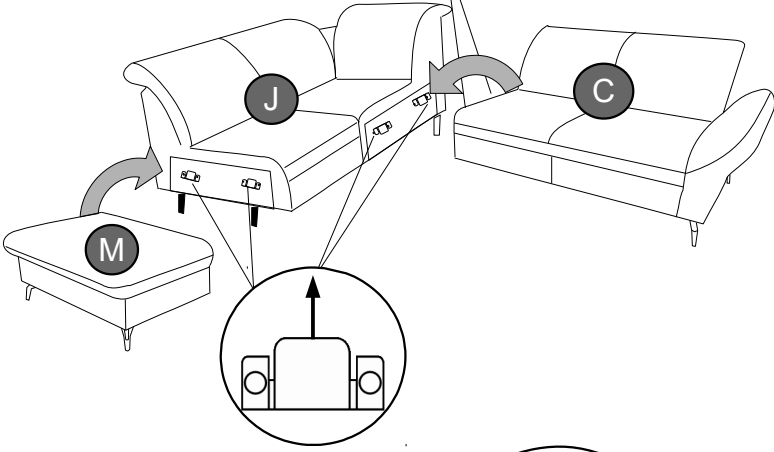
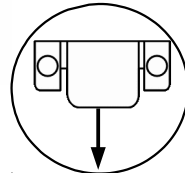
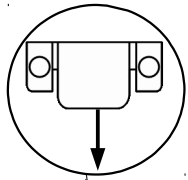
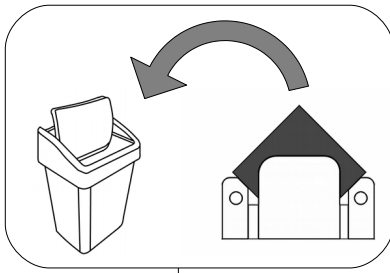

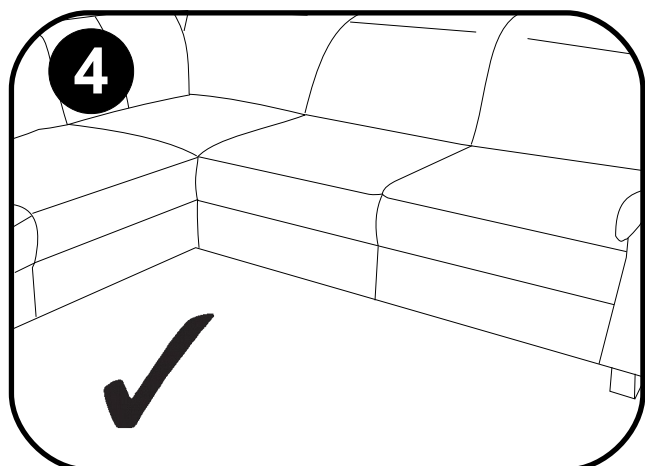
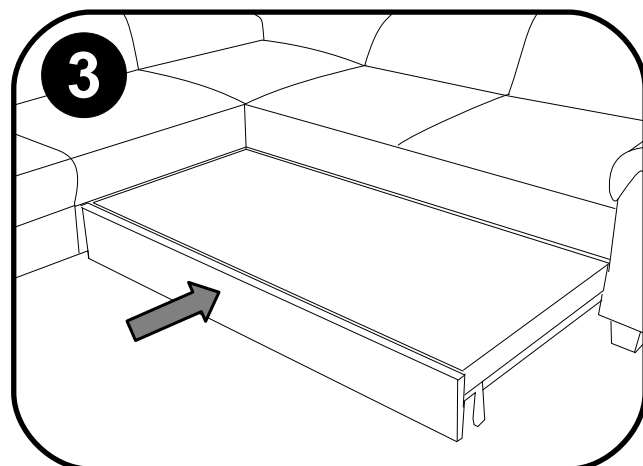
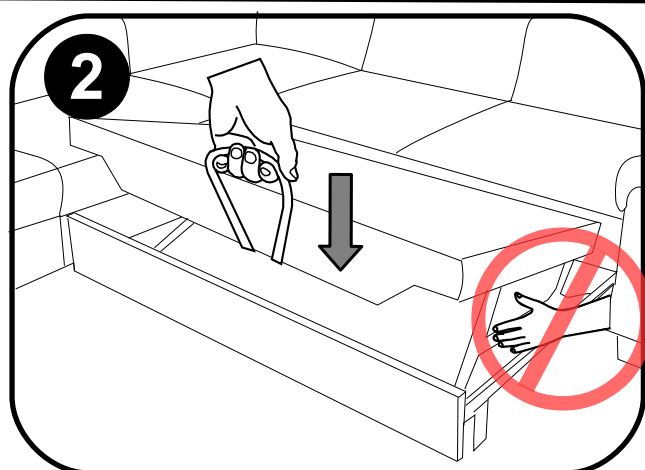
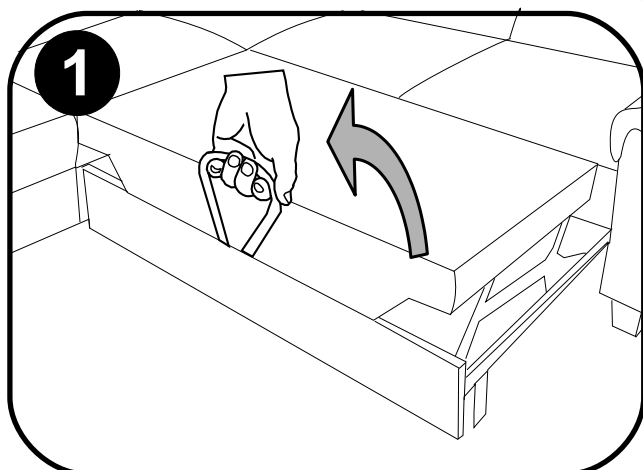
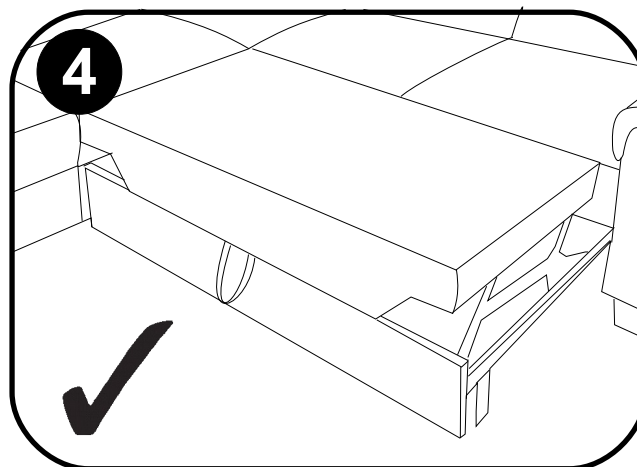
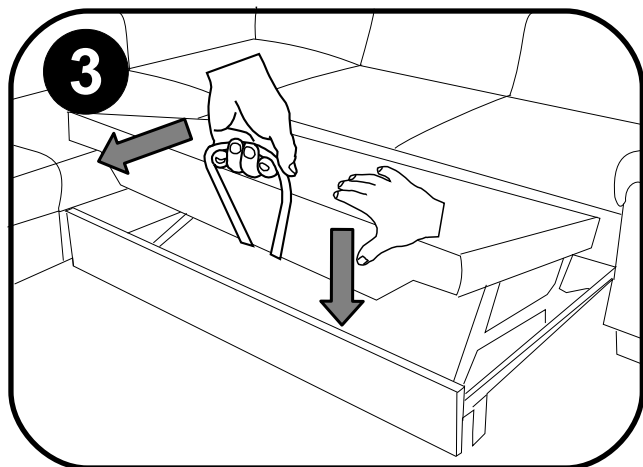
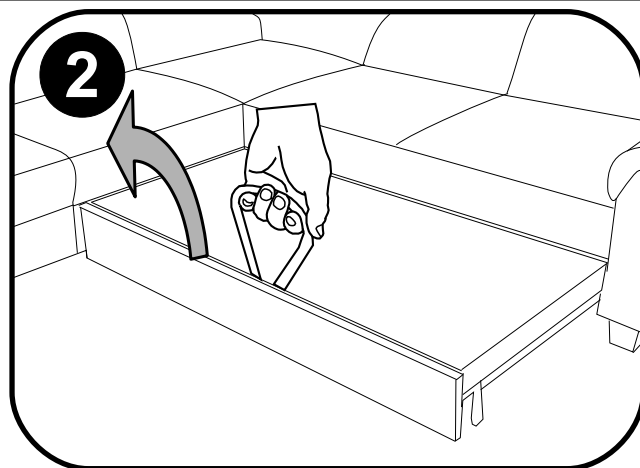
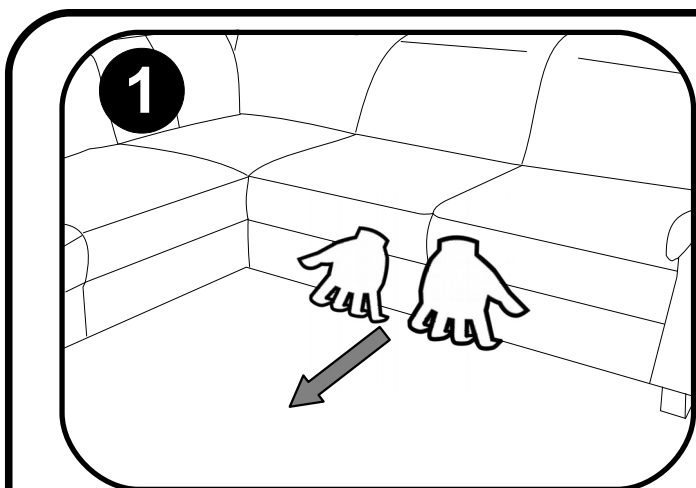
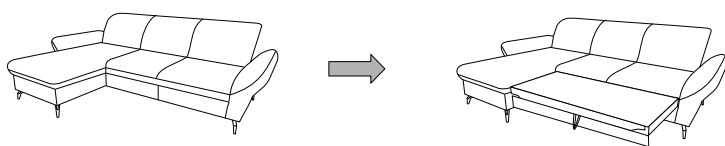





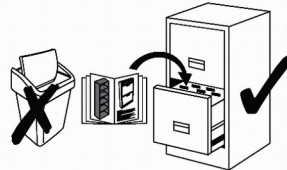
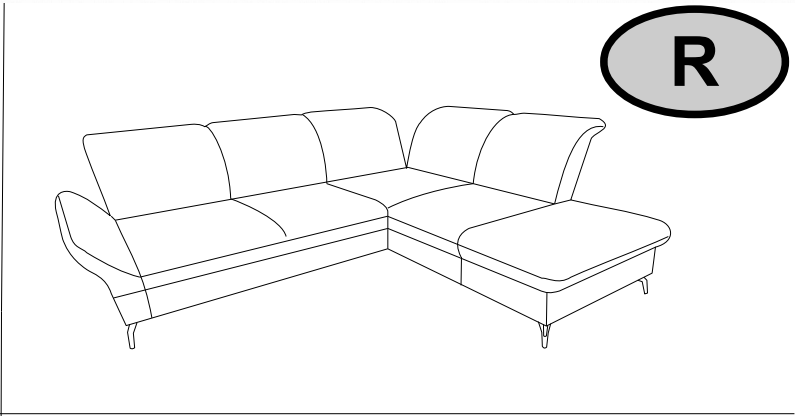
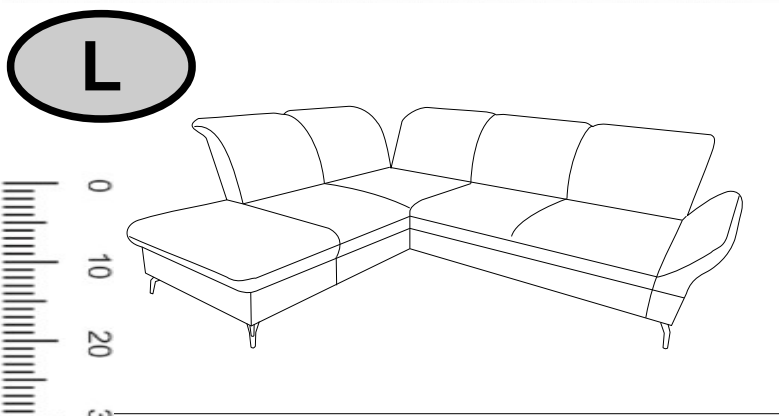
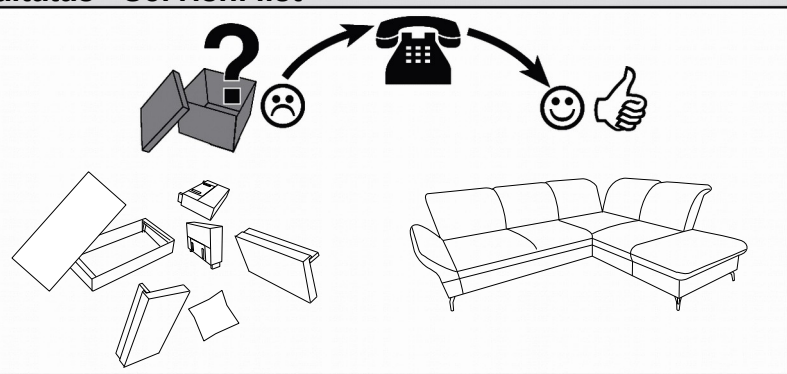

Name · Naam · Nazwa · İsim · Название · Nume · Nome · Názov · Názov ·
 Název · Neve

LEANDRO V

Typ · Type · Tip · Тип · Tipo · Típus

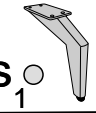
g H-120 	v H-120 	i L-4 	s H-120  s₁ 	q M6*25 [mm] 
--	--	--	--	---

