

*Ragnar*  
Art. Nr. 3418850  
1/7

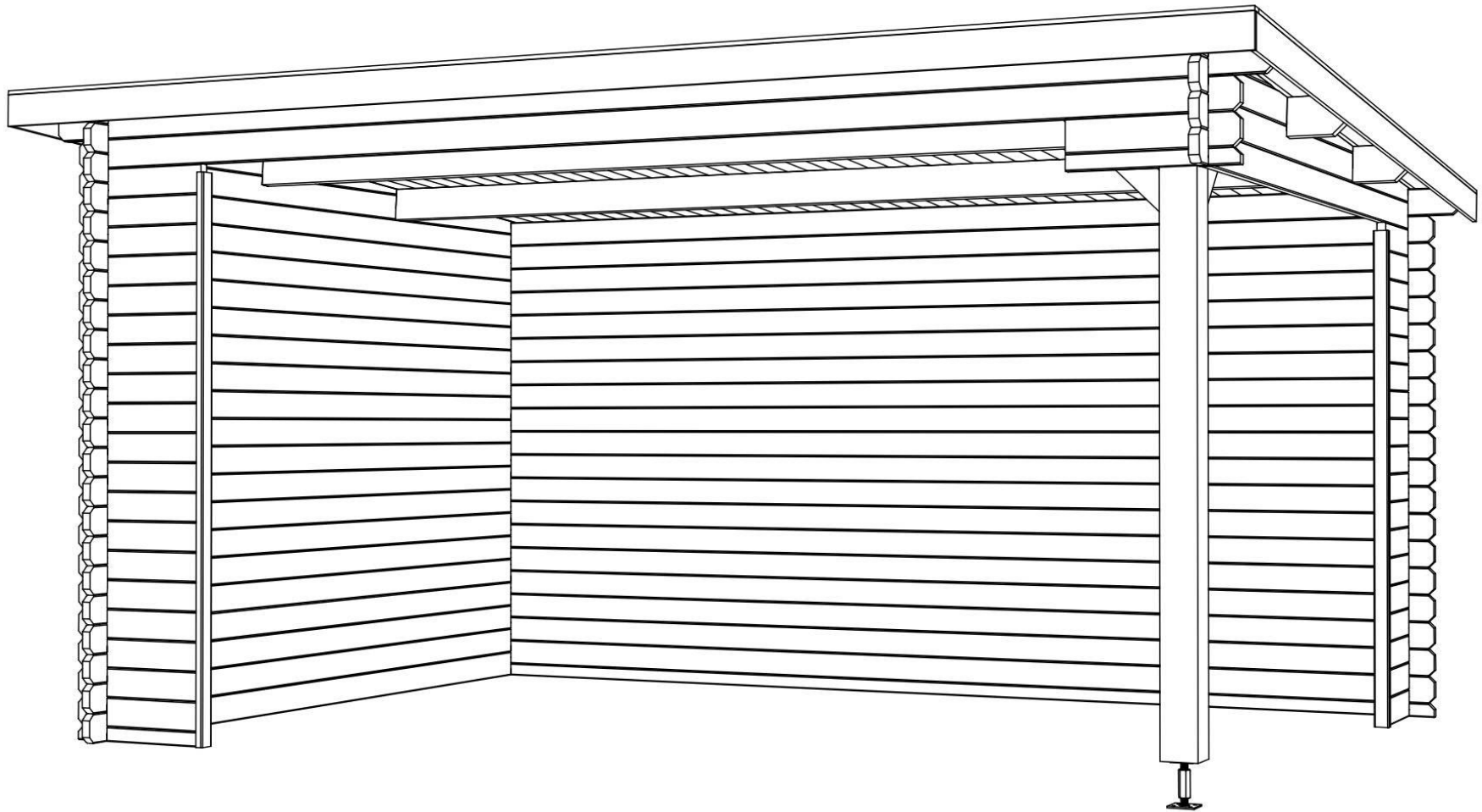

Art. Nr. 3418850

Groundplan - Grundplan - Plan de masse - Planimetria - Plattegrond - Põhiplaan

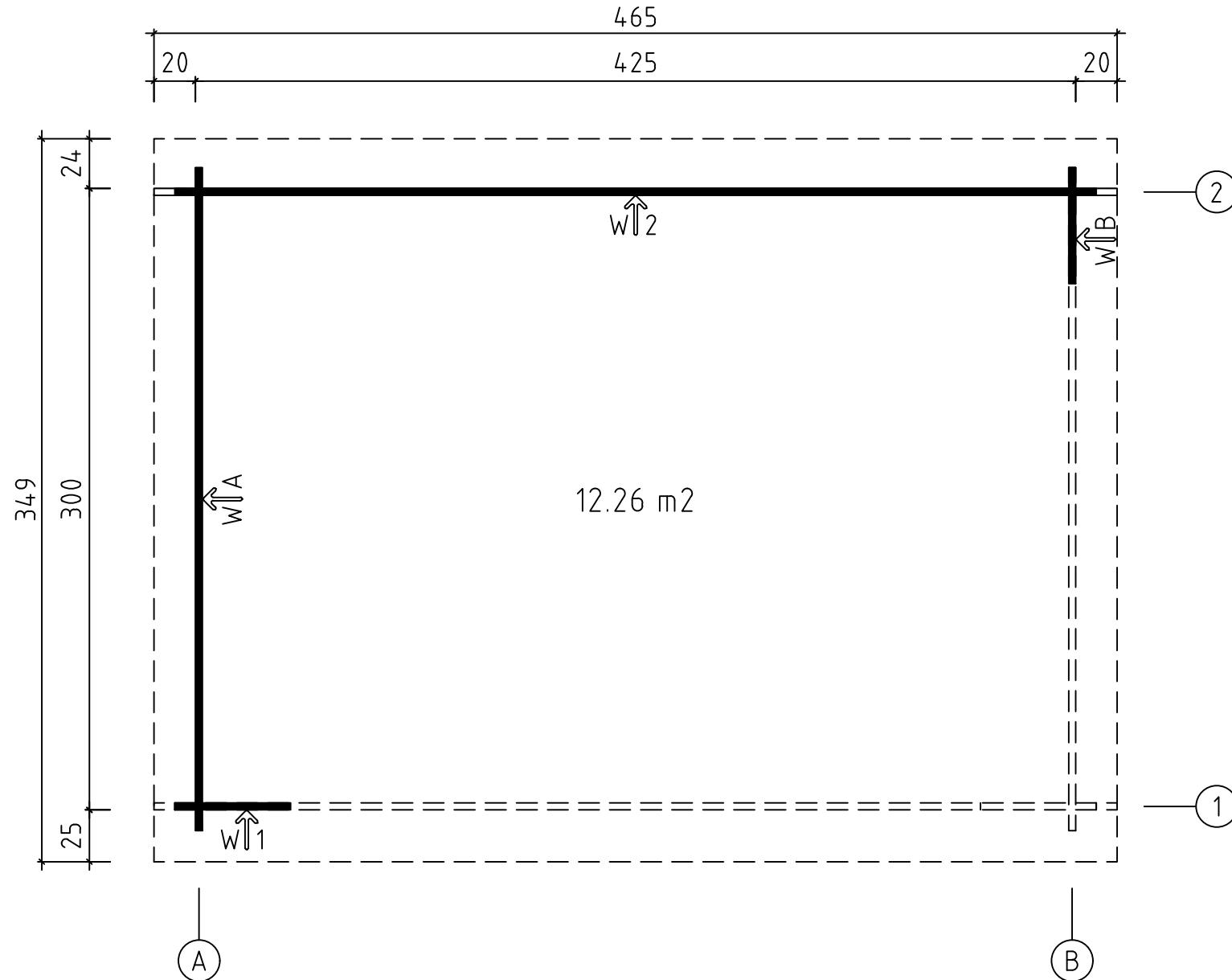



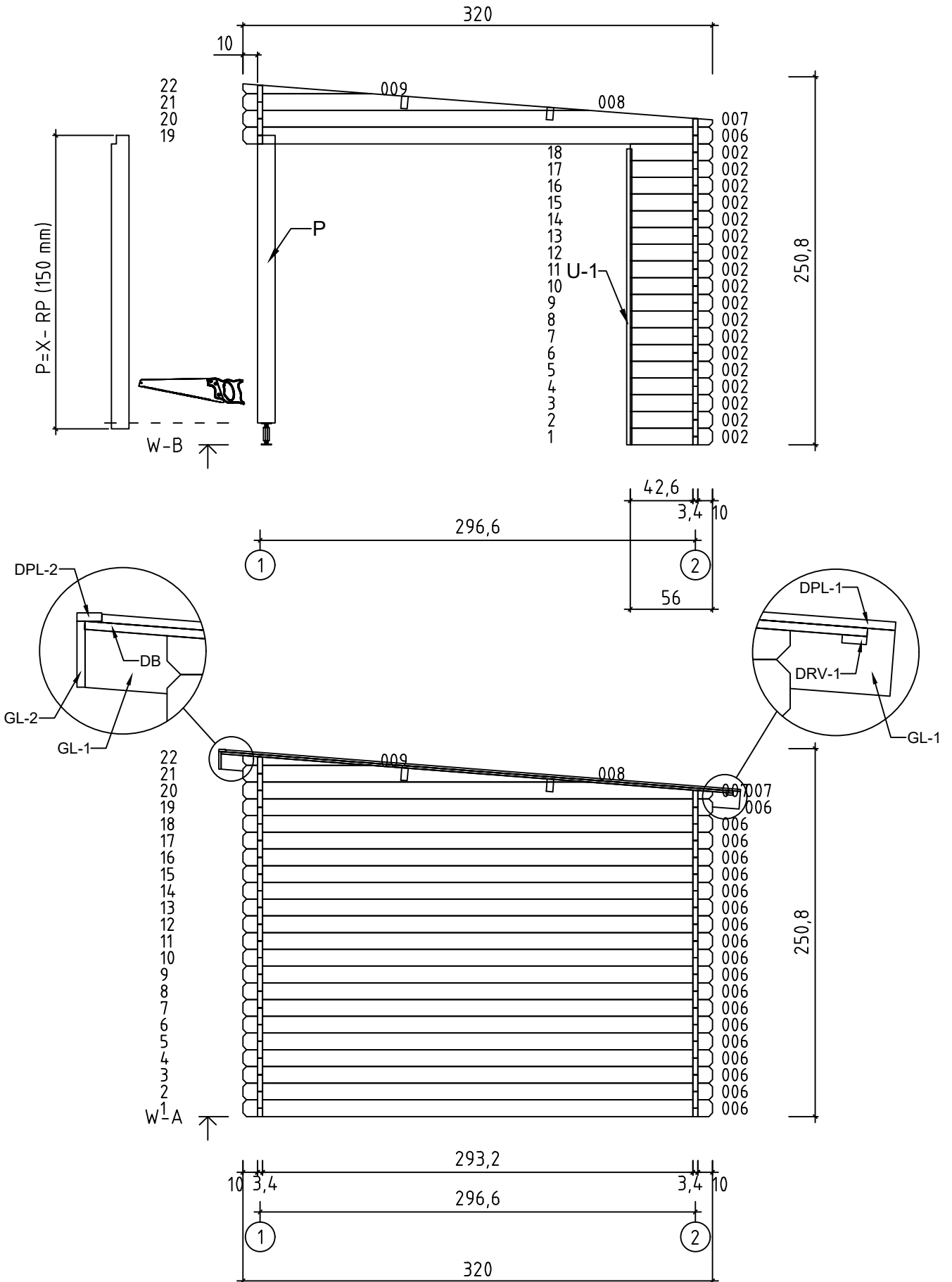

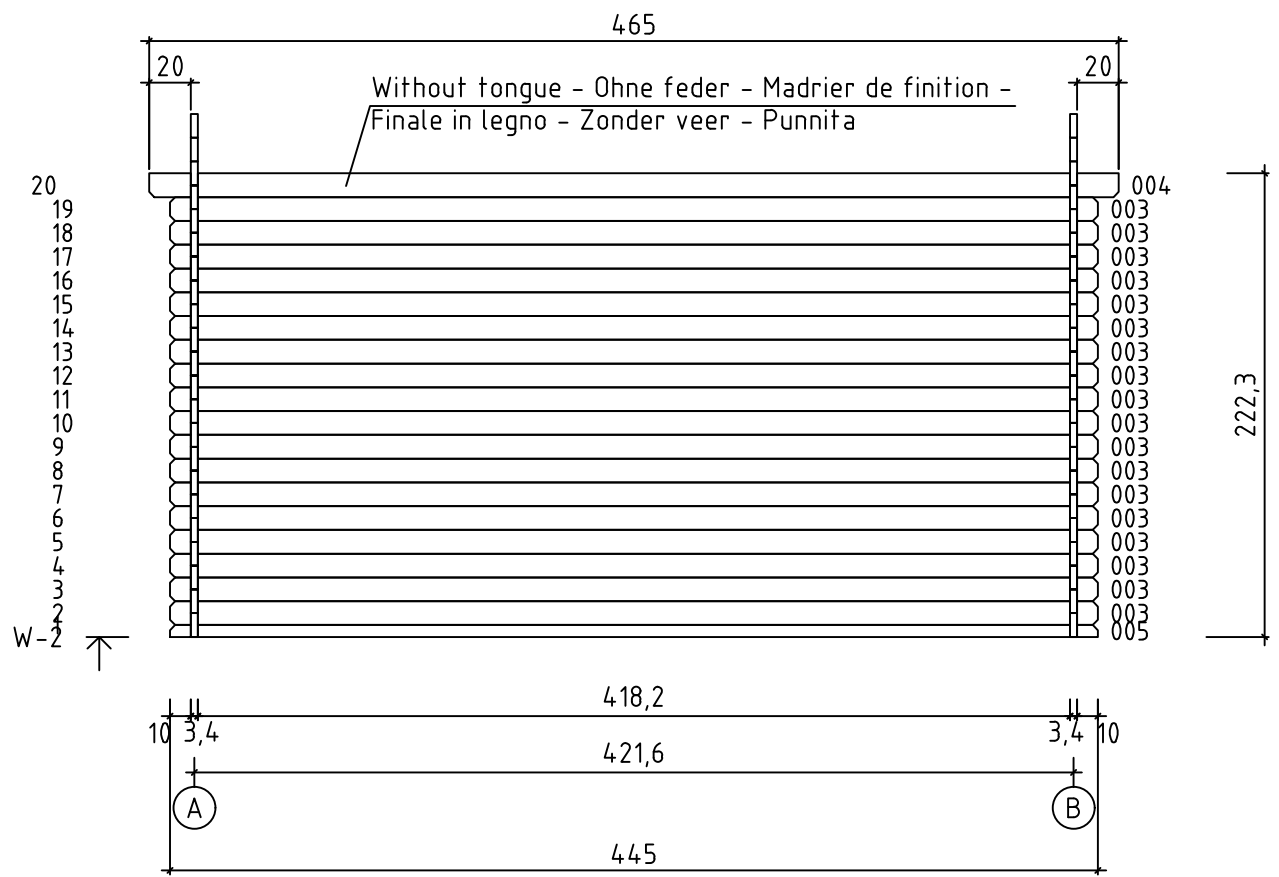
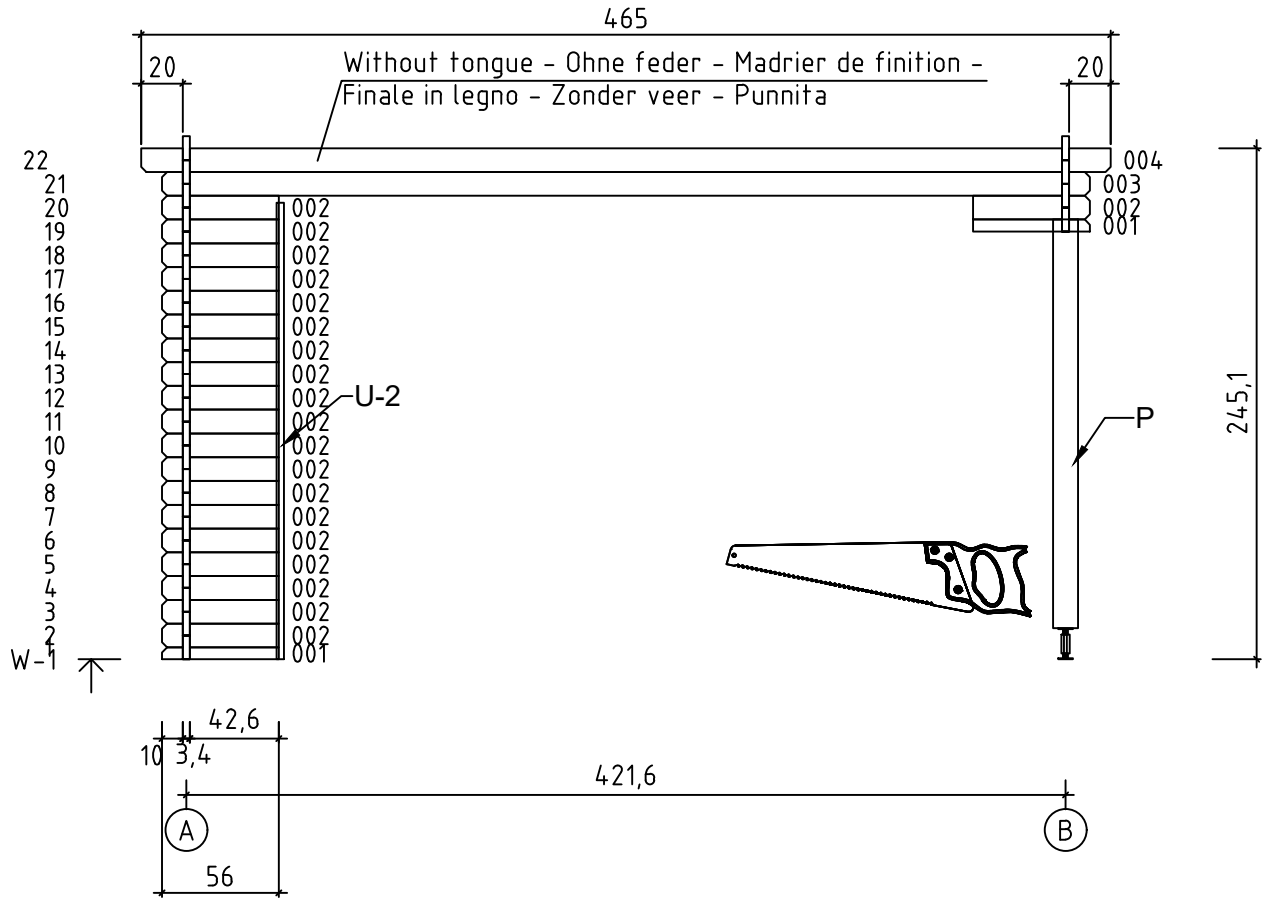

Art. Nr. 3418850

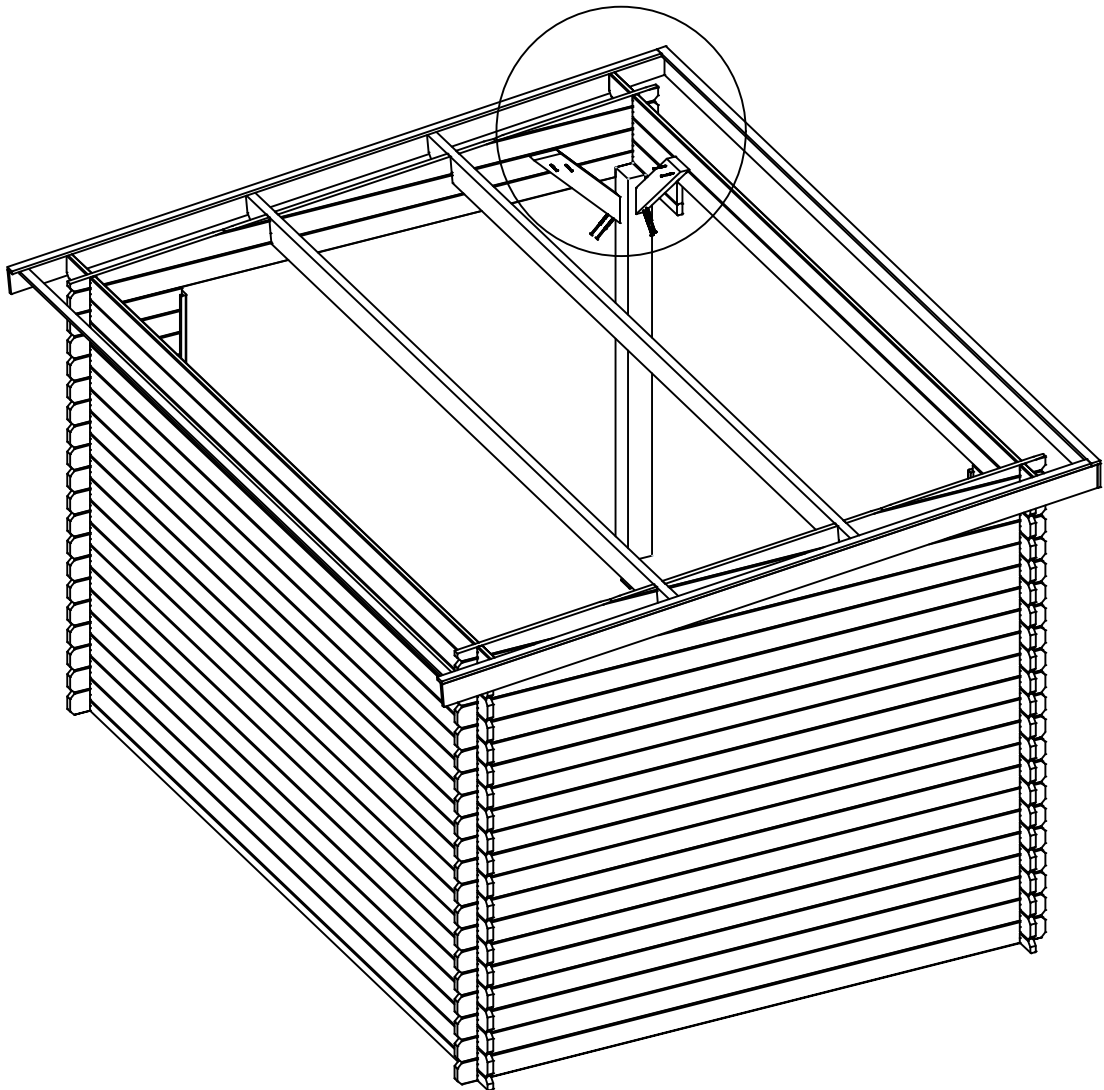
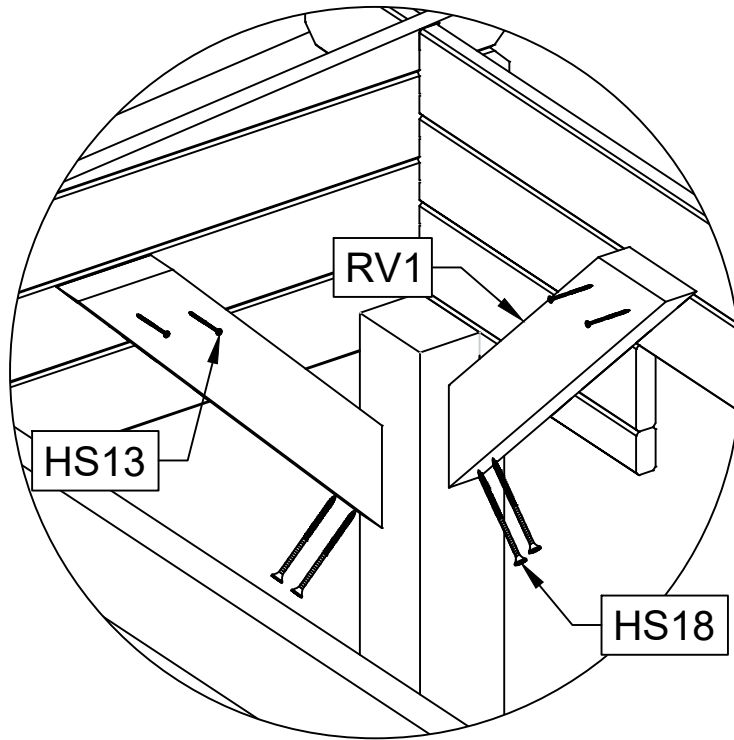

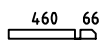
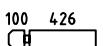
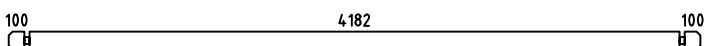
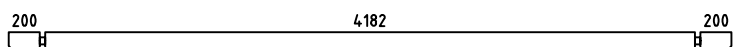
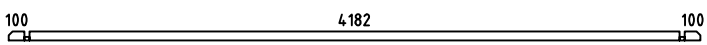
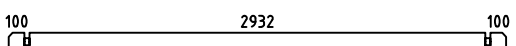
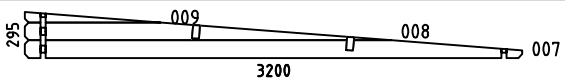
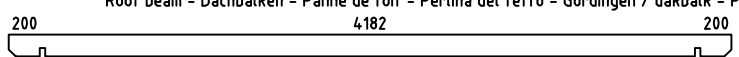
Art. Nr. 3418850

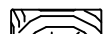
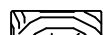
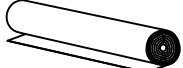
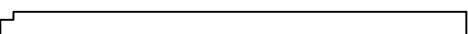
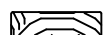
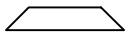
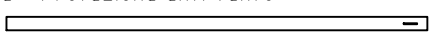

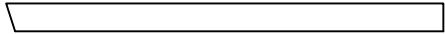
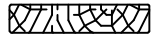
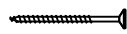

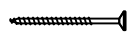
Pos	15.10.2019 Piece list - Stückliste - Liste des pièces - Elementi - Stuklijst - Tükítabel Art. Nr. 3418850 6/7	Q	P (mm)	L (mm)
001		2	34x57	560
002		38	34x114	560
003		19	34x114	4450
004		2	34x114	4650
005		1	34x57	4450
006		20	34x114	3200
WA-1 WB-1		1 1		
A-PR1	Roof beam - Dachbalken - Panne de toit - Perlina del tetto - Gordingen / dakbalk - Pärlin 	2	44x140	4650
DB	Roof boards - Dachbretter - Voliges - Perlina per tetto - Dakhout - Katuselaud 	52	90x15	3500
DPL-1	Roofing felt fillet - Dachpappenleiste - Baguette de fixation du feutre bitumeux - Asse per fissaggio guaina bituminosa - Afdeklijst asfaltpapier - Katusepapiilist 	2	15x45	3520
DPL-2	Roofing felt fillet - Dachpappenleiste - Baguette de fixation du feutre bitumeux - Asse per fissaggio guaina bituminosa - Afdeklijst asfaltpapier - Katusepapiilist 	1	15x45	4680
DPP-1	Roofing felt (strip) - Dachpappe (bahnen) - Feutre bitumeux (bande) - Cartone catramato - Asfaltpapier (baan) - Katusepapp 	4		4750
P	Post - Pfosten - Poteau - Piede registrabile - Stijl - Post 	1	120x120	2000
DRV-1	Roof edge reinforcement - Dachrandverstärkung - Corniere de renfort de bord de toit - Rinforzo x tetto - Dakrand versterking - Räästatugevdus 	2	15x45	2325
BL	Beam - Balkenlage - Solive(s) - Trave - Balk (gording) - Tala 	2	44x120	620
KFS-1	Storm protection - Sturmleiste - Latte anti-tempete - Protezione anti vento - Stormverankering / beveiliging - Tormikinnitusliist 	3	22x45	2500
U-1	U-profile - U-profils - Profile u - Profilo ad u - U-profiel - U-profiil 	1	35x70	2017
U-2	U-profile - U-profils - Profile u - Profilo ad u - U-profiel - U-profiil 	1	35x70	2190
GL-1	Gable moulding - Giebelleiste - Planche de rive - Finitura per frontale e retro del tetto - Gevellijst - Viilulaud 	2	15x120	3550
GL-2	Gable moulding - Giebelleiste - Planche de rive - Finitura per frontale e retro del tetto - Gevellijst - Viilulaud 	1	15x120	4680
HS9	Screw for u-profile - Schraube zur Befestigung u-profils - Vis a tete fraisée pour profil u - Vite per profilo ad u - Schroef ter bevestiging u-profiel - Kruvi U-profiilile 	12	3.5x50	
HS9	Screw for gable moulding - Schrauben für Giebelleiste - Vis pour fixation planche de rive - Vite per fissare finiture davanti e dietro del tetto - Schroef voor gevellijst - Kruvi viilulauale 	30	3.5x50	
HS4	Screw for roof edge reinforcement - Schrauben für Dachrandverstärkung - Vis pour fixation corniere renfort de bord de toit - Viti x rinforzo bordo tetto - Schroef voor dakrand versterking - Kruvi räästatugevdusele 	12	3x30	

