

PALM BEACH V









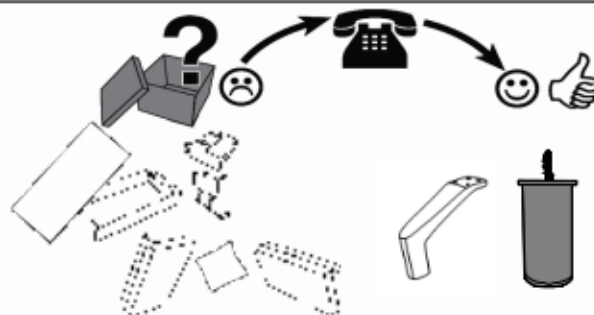

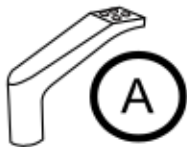
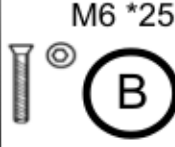
- | | | | |
|-----------|--|-----------|---|
| D | MONTAGEANLEITUNG
BEDIENUNGSANLEITUNG | GB | ASSEMBLY INSTRUCTIONS
INSTRUCTION MANUAL |
| NL | HANDLEIDING VOOR DE MONTAGE
GEBRUIKSAANWIJZING | PL | INSTRUKCJA MONTAŻU
INSTRUKCJA OBSŁUGI |
| TR | MONTAJ TALIMATI
KULLANIM KLAVUZU | RU | ИНСТРУКЦИЯ ПО МОНТАЖУ
ИНСТРУКЦИЯ ПО ЭКСПЛУАТАЦИИ |
| RO | INSTRUCȚIUNI DE INSTALARE
INSTRUCȚIUNI DE UTILIZARE | IT | ISTRUZIONI DI MONTAGGIO
MANUALE DI ISTRUZIONI |
| FR | NOTICE DE MONTAGE
MANUEL INSTRUCTIONS | SK | MONTÁŽNY NÁVOD
NÁVOD NA POUŽITIE |
| HU | KÖZGYŰLÉS UTASÍTÁSOK
KEZELÉSI UTASÍTÁS | CZ | MONTÁŽNÍ NÁVOD
NÁVOD K POUŽITÍ |
| SI | NAVODILA ZA MONTAŽO
NAVODILA ZA UPORABO | PT | INSTRUÇÕES DE MONTAGEM
MANUAL DO USUÁRIO |
| ES | INSTRUCCIONES DE MONTAJE
MANUAL DEL USUARIO | HR | UPUTE ZA MONTAŽU
UPUTE ZA UPOTREBU |

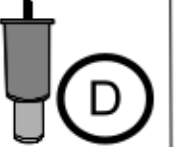
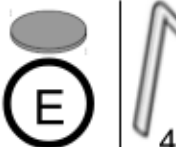
Name · Naam · Nazwa · İsim · Название · Nume · Nome · Nazov · Nazov
 Název · Neve

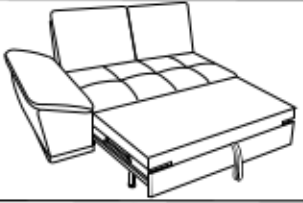
PALM BEACH V

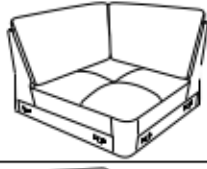
Typ · Type · Tip · Тип · Tipo · Típus

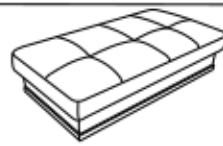

	 A	 M6 *25 B	 C	 D	 E	 4L F
 G	x2	x8	/	/	x2	x1
 P	x2	x8	/	/	x2	
 H	x3	x12	x1	x2	x6	
 K	x1	x4	x3	/	x4	
 L	x2	x8	/	x1	x3	
 N	x4	x16	/	/	x4	
 O	/	/	/	/	/	
 R	/	/	/	/	/	

Name · Naam · Nazwa · Ísim · Название · Nume · Nome · Názov · Názov ·
 Název · Neve

PALM BEACH V

Typ · Type · Tip · Тип · Tipo · Típus

2501+37+90+19-8242+89+90, 8241+89+90-2503+37+90+19

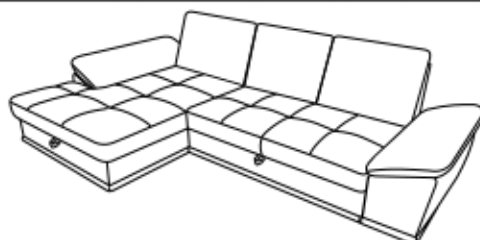
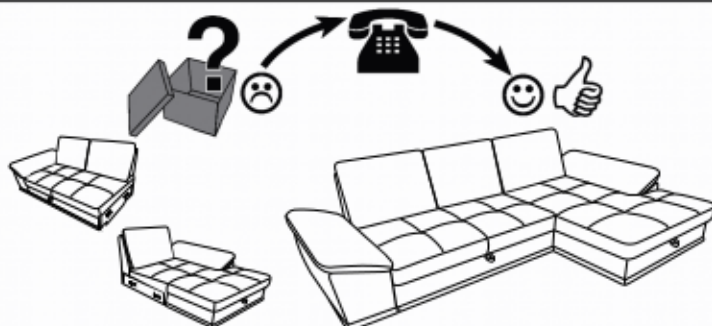
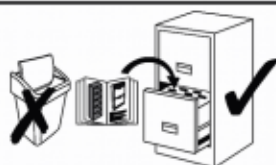

G / P



I / S



H



J

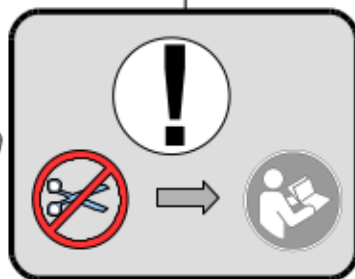
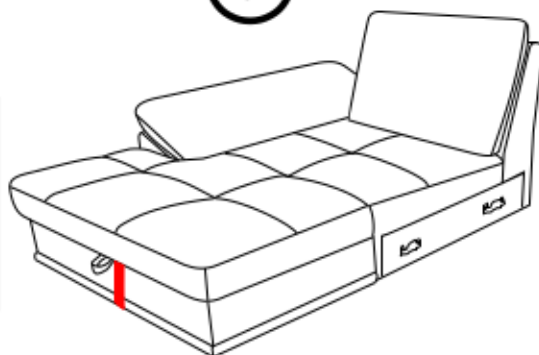

N

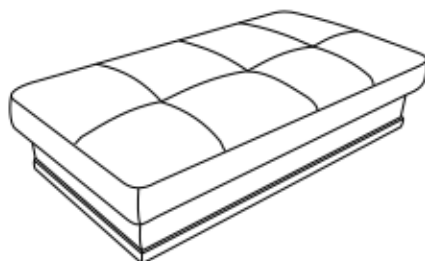

Name · Naam · Nazwa · İsim · Название · Nume · Nome · Název · Názov ·
 Název · Neve

PALM BEACH V

Typ · Type · Tip · Тип · Tipo · Típus

824 1+89+90-2500+19+37-5010-1073+37+88,
 1071+37+88-5010-2500+19+37-8242+89+90

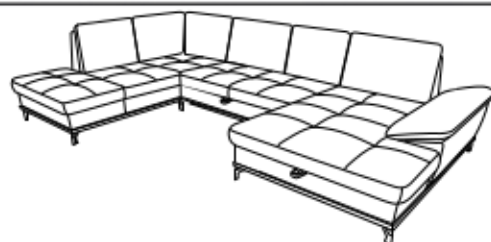
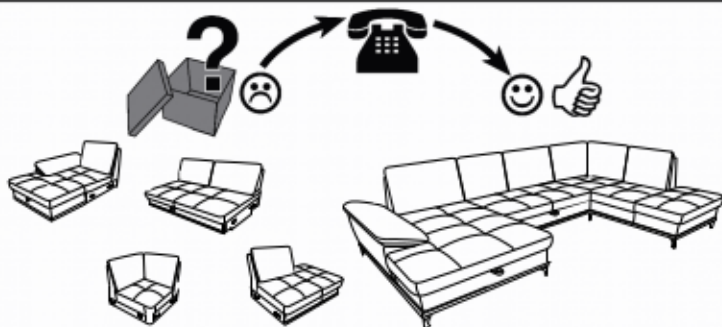
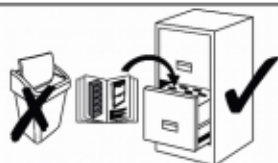

(J)

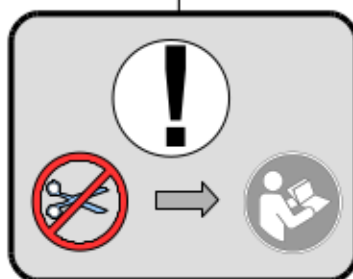

(H)



(O)/(R)



(O)/(R)



(K)



(K)

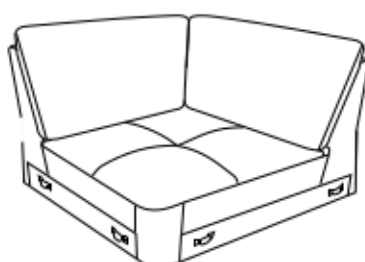

(L)



(M)



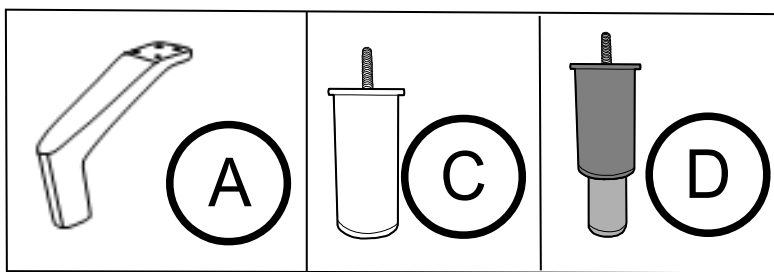

(G)

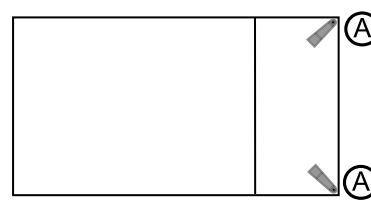
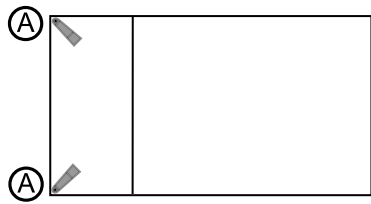

(I)

(P)

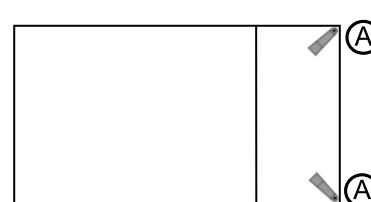
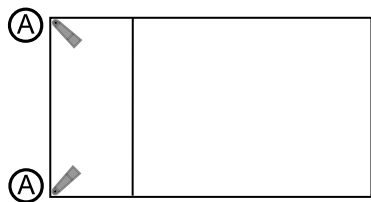

(S)

(H)

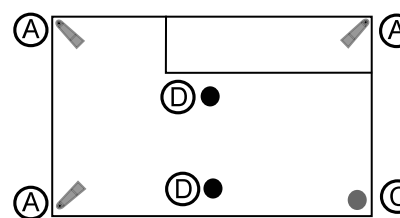
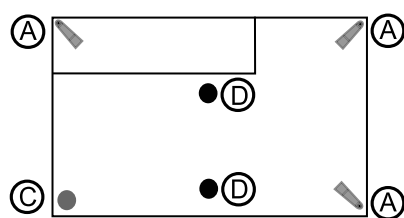

(J)

(K)

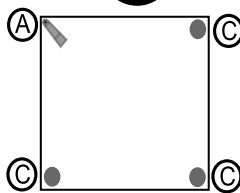

(L)

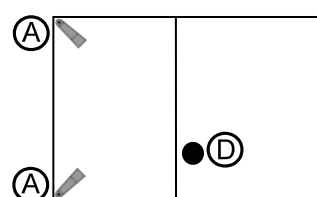
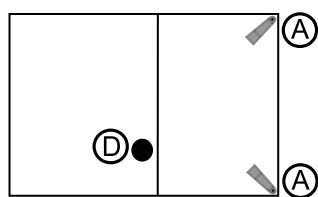

(M)

(N)



(O)/(R)

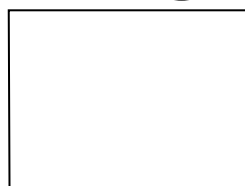

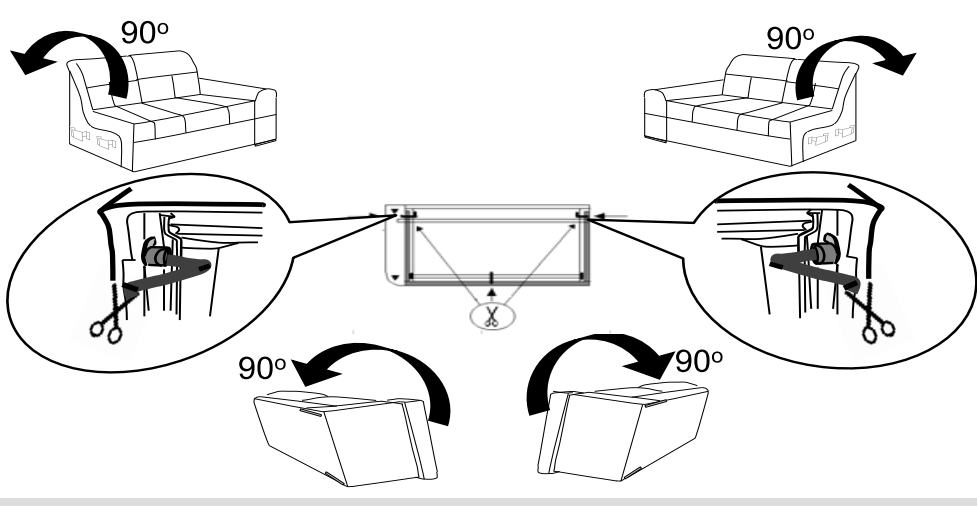
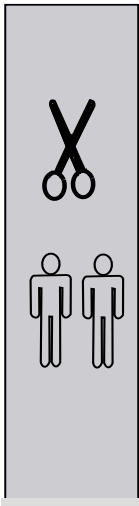

1

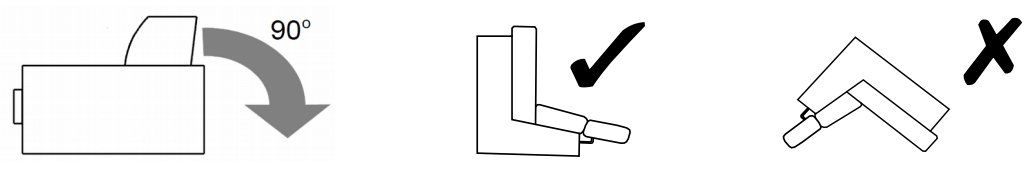

2

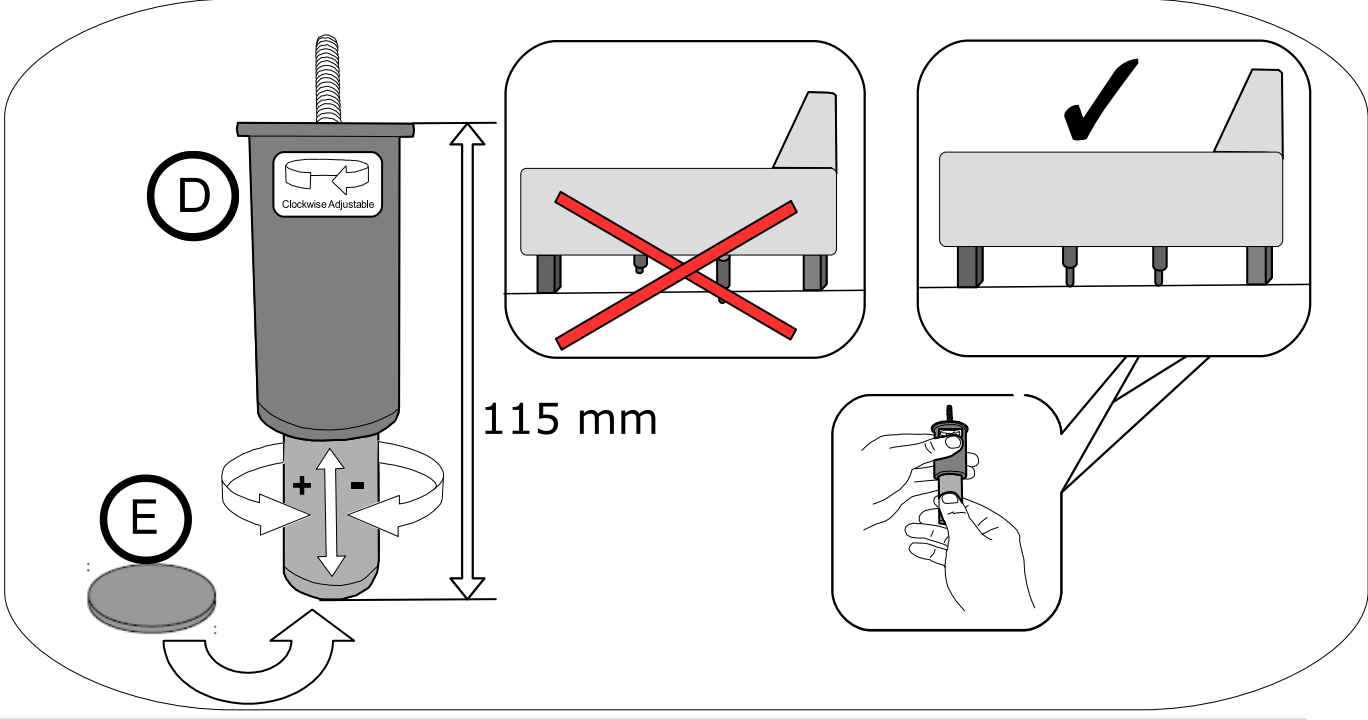
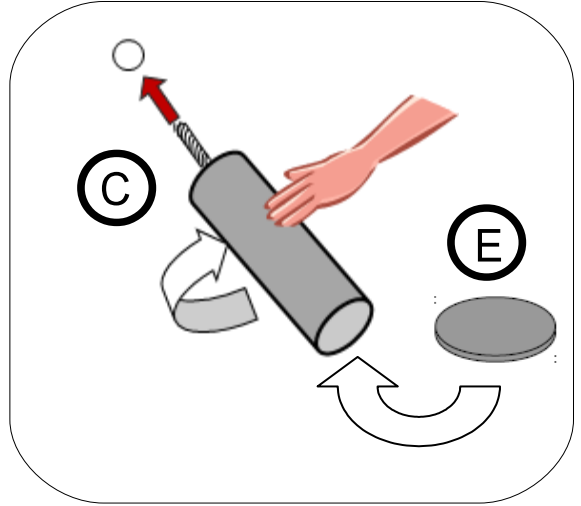
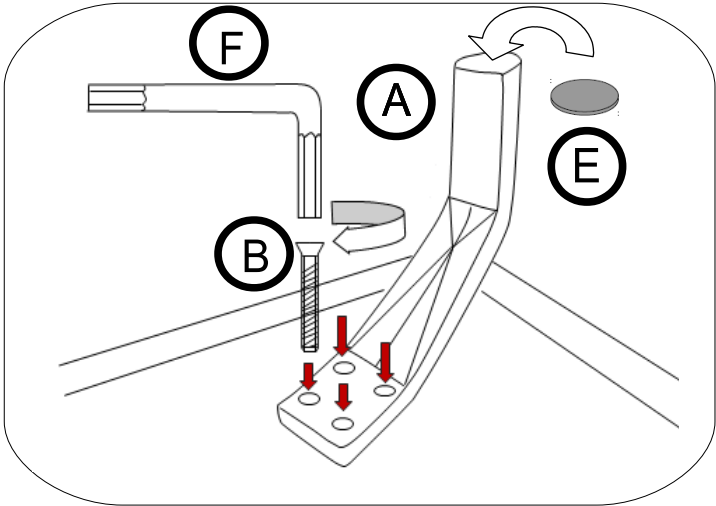

3

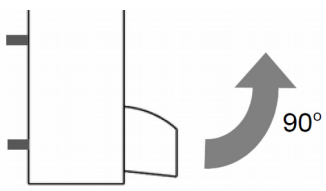

6

1



2

(G)/(P)

(H)

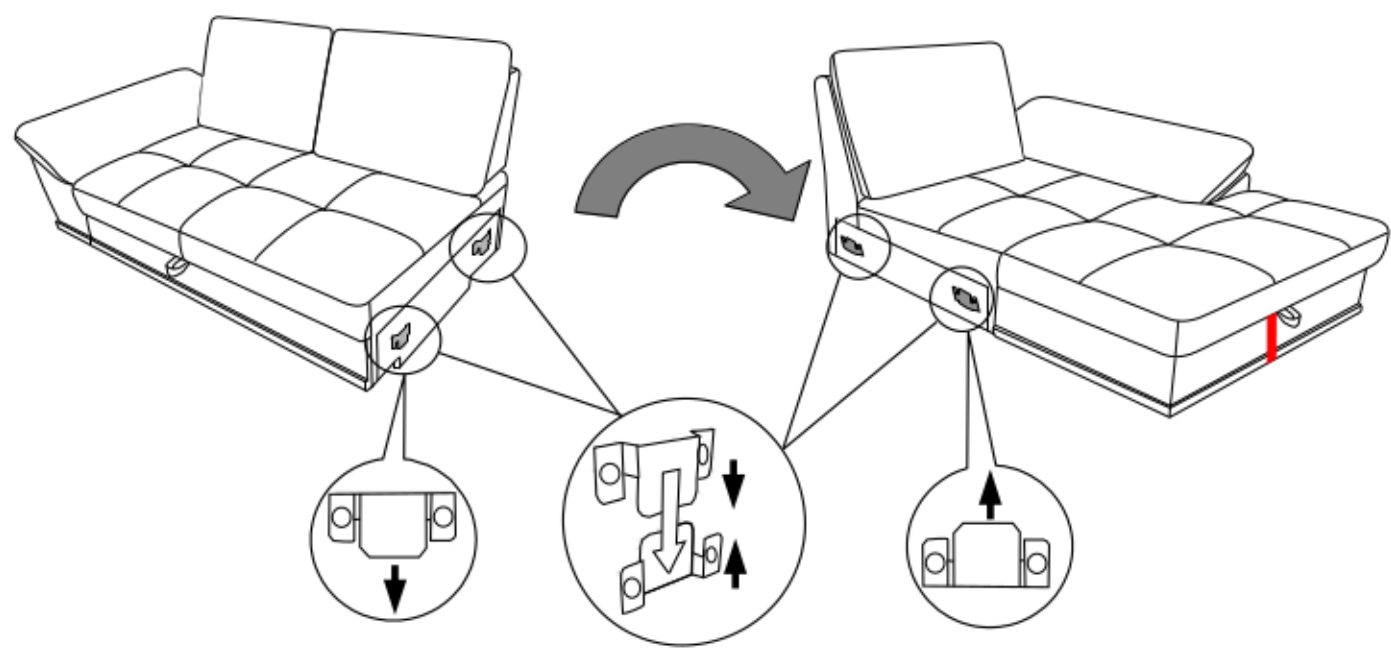

3



4

(J)

(I)/(S)

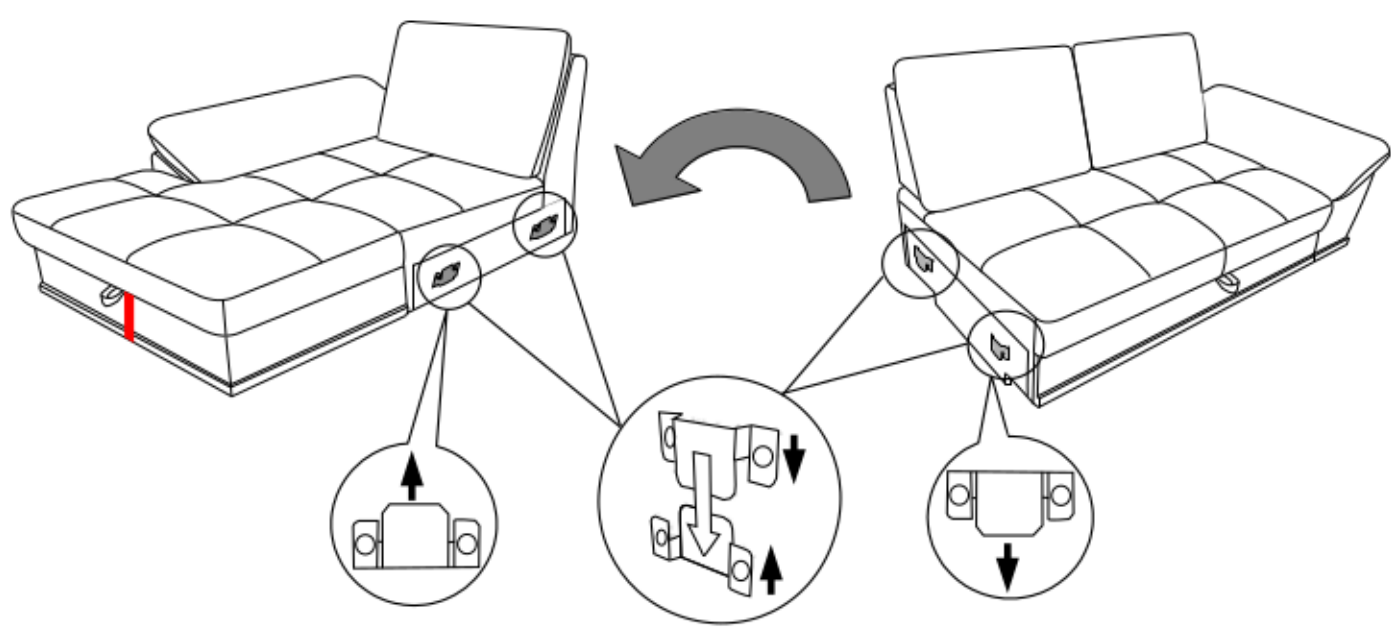

5



6

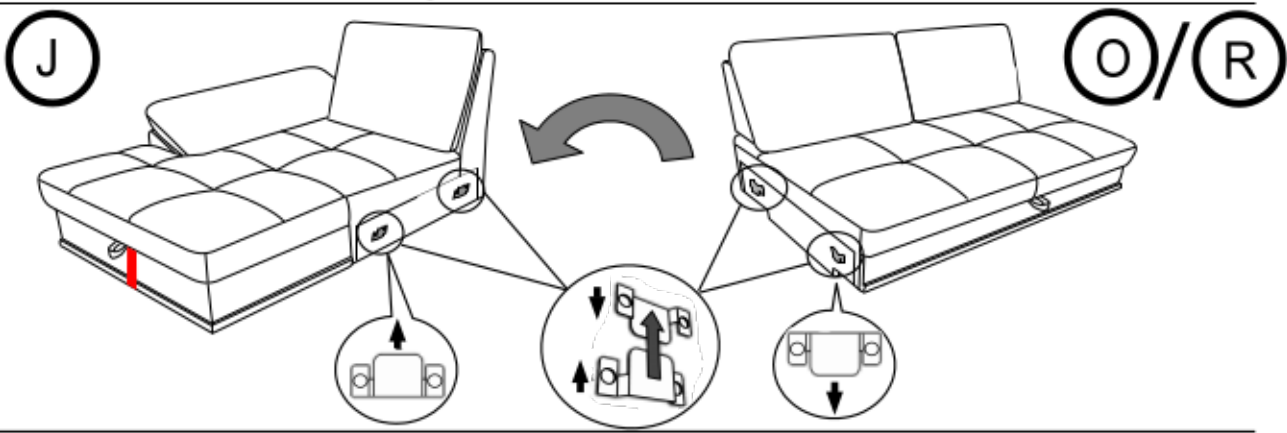

7



8

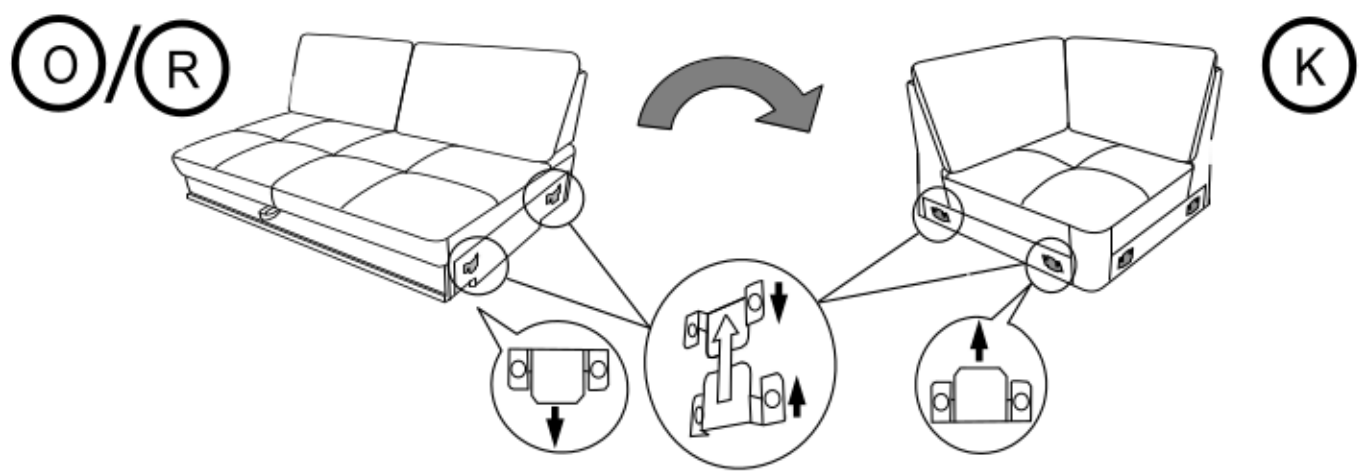

9

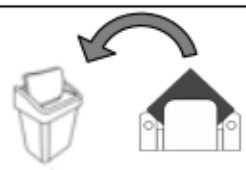

10

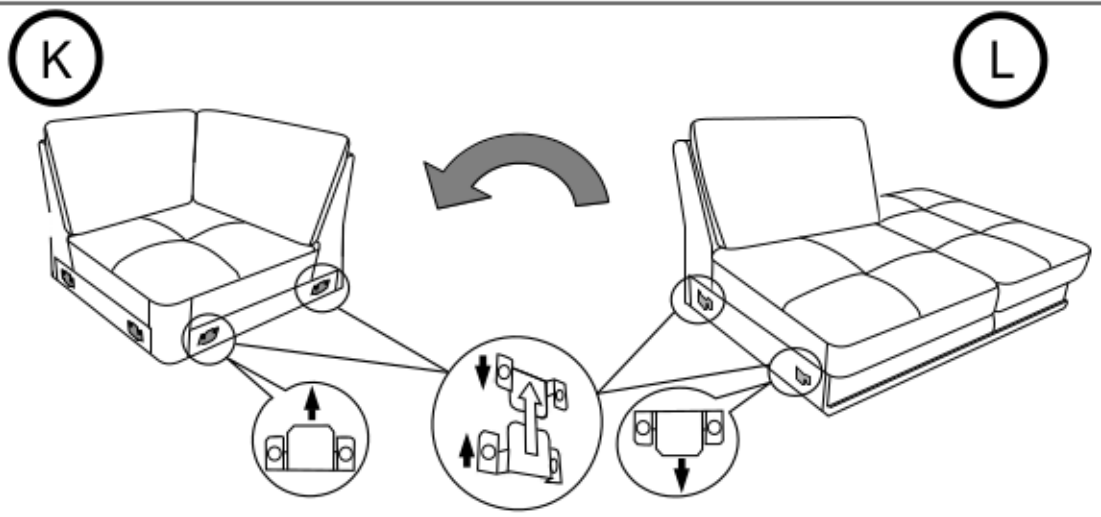

11



12

M

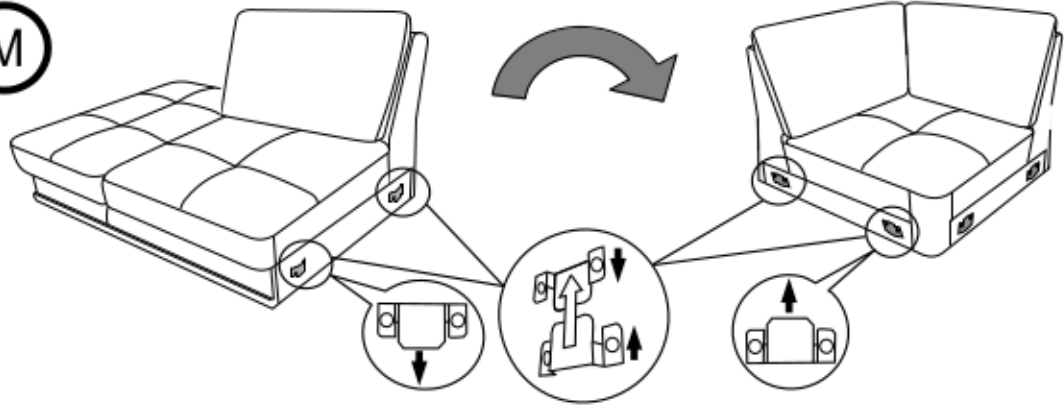

K

13



14

K

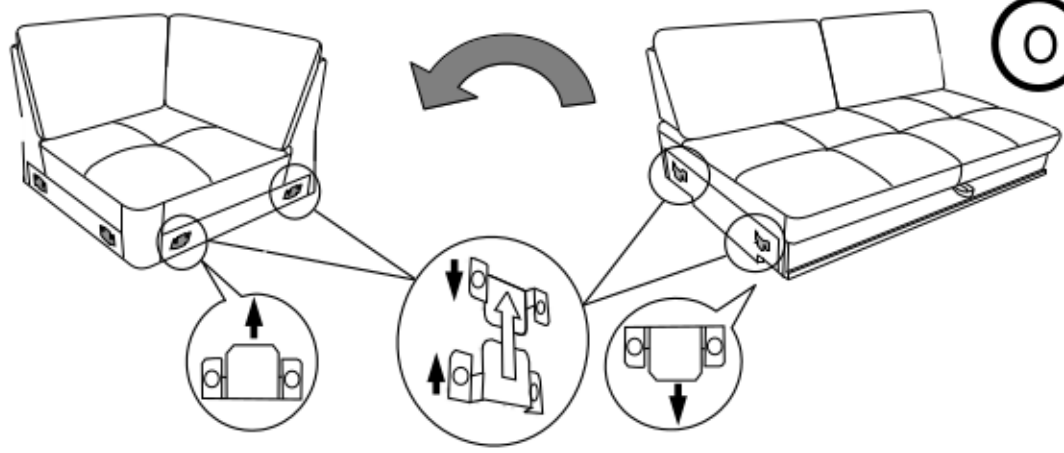

O/R

15



16

O/R

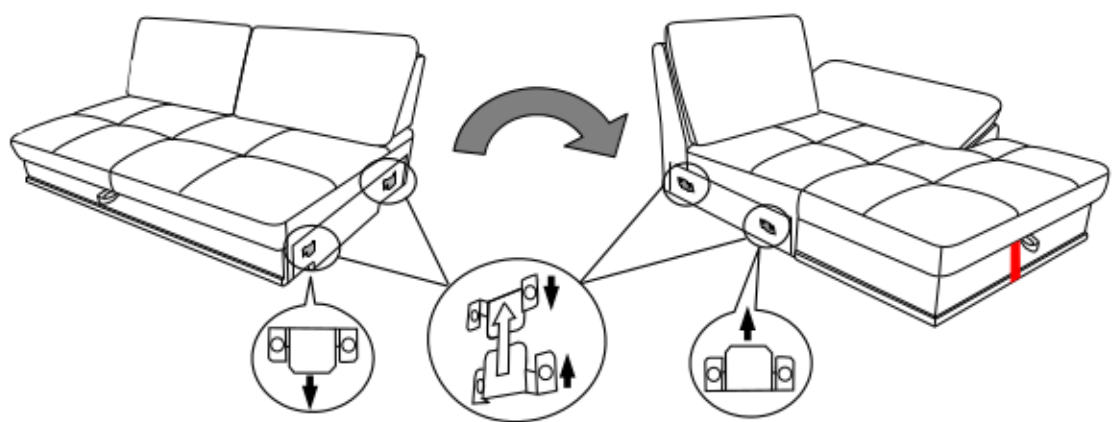

J

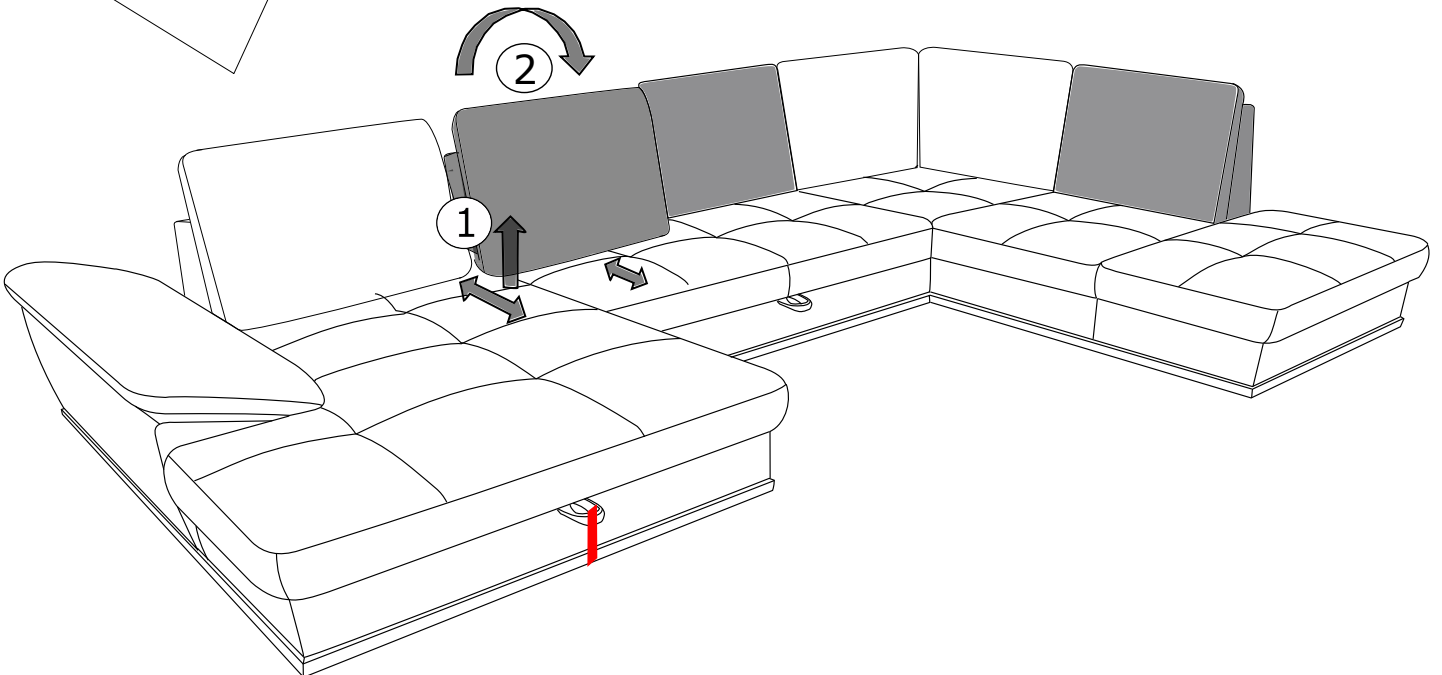
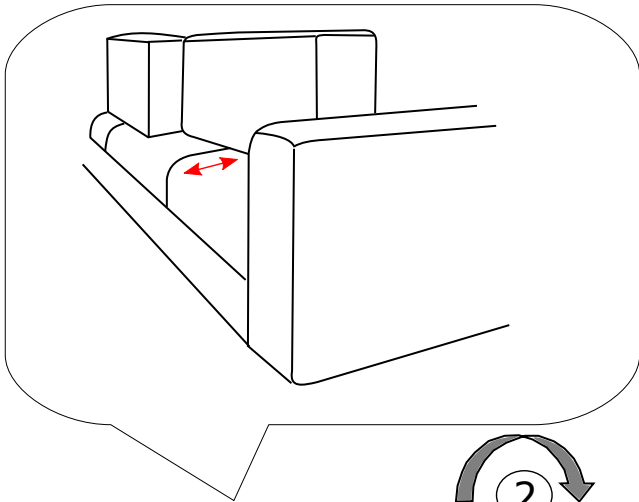
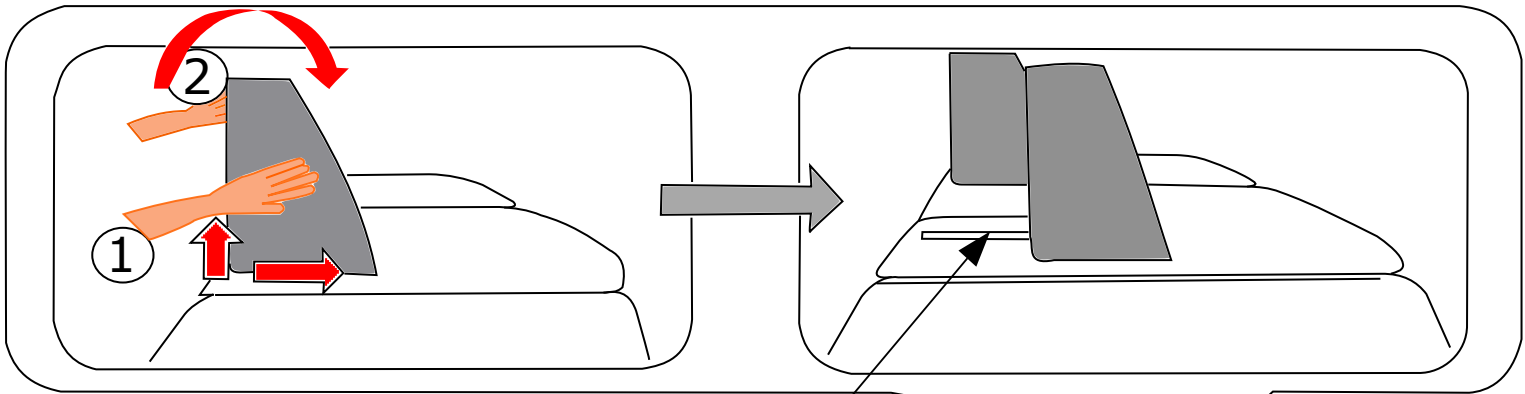
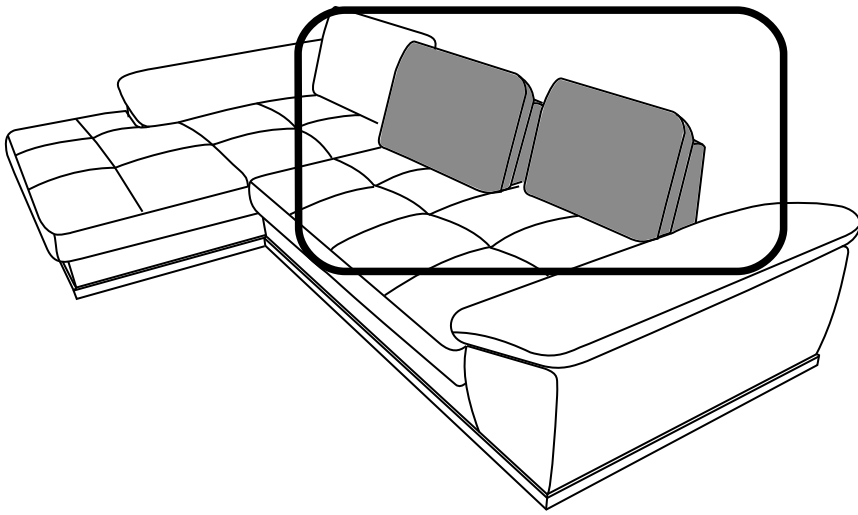

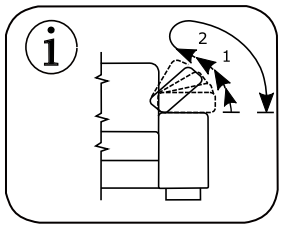

x2

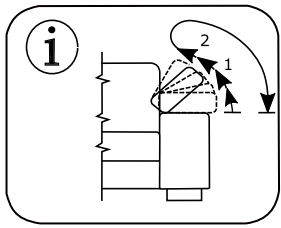
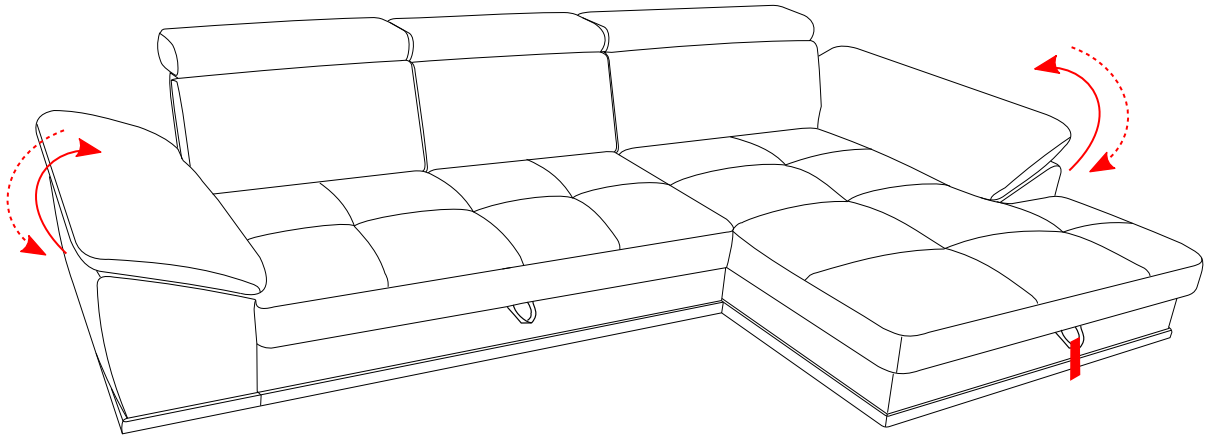

x2

