

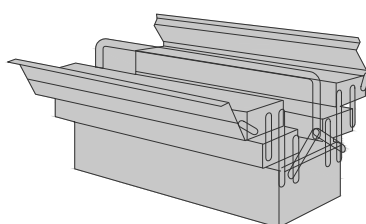

- | | | | |
|---|-----------------------------|---|-------------------------|
| Ⓧ | Montageanleitung | Ⓧ | Assembly instructions |
| Ⓧ | Notice de montage | Ⓧ | Istruzioni di montaggio |
| Ⓧ | Handleiding voor de montage | Ⓧ | Instrukcja montażu |
| Ⓧ | Montážní návod | Ⓧ | Návod na montáž |
| Ⓧ | Szerelési utmutató | Ⓧ | Instrucțiuni de montaj |
| Ⓧ | Montaj talimatı | Ⓧ | Инструкция по монтажу |

Dokument-Nr.: KC-179
Ausgabe: 20201106

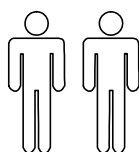



Service • Assistenza • Dienstverlening • Serwis Servis • Szerviz • Сервисная служба	
Наме • Nom • Nome • Naam • Nazwa • Имя • Názov • Név • Депутат • Isim • Название	EVELINESE
Nr. • No. • N° • Номер • Č • Sz	5380 7629 7522 4668 9175 7132
Typ • Type • Тип • Típus • Típo • Тип	81.5X74.5X74CM
	KC-179

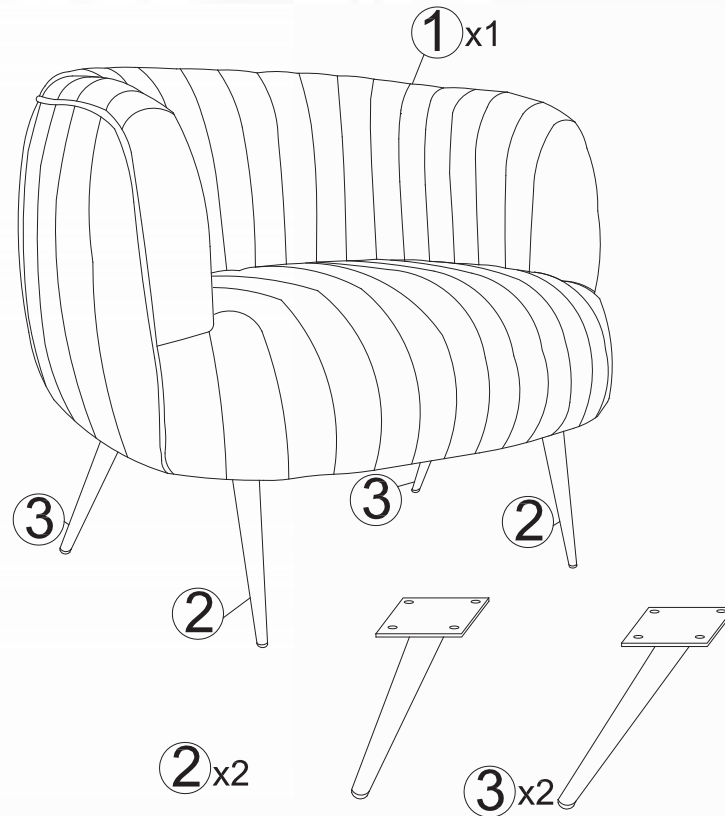



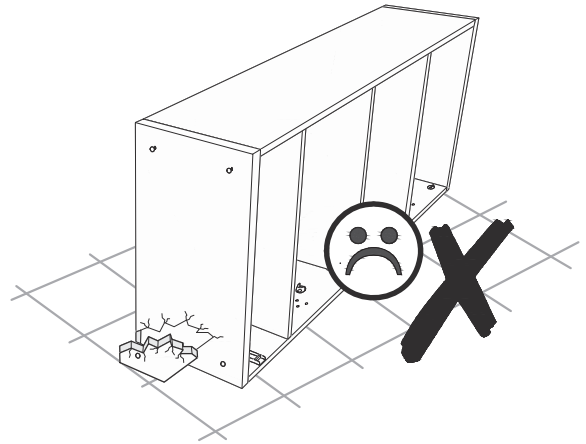
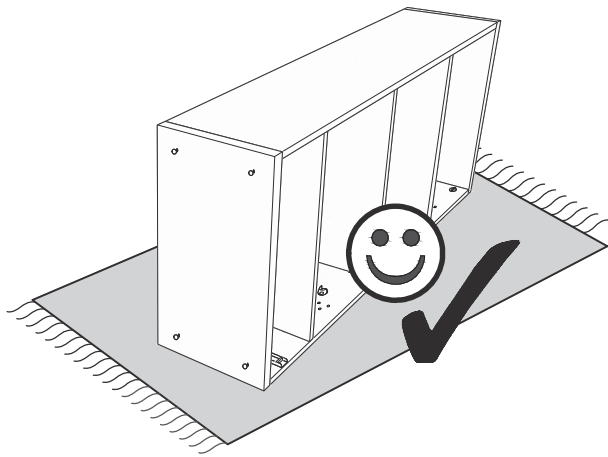

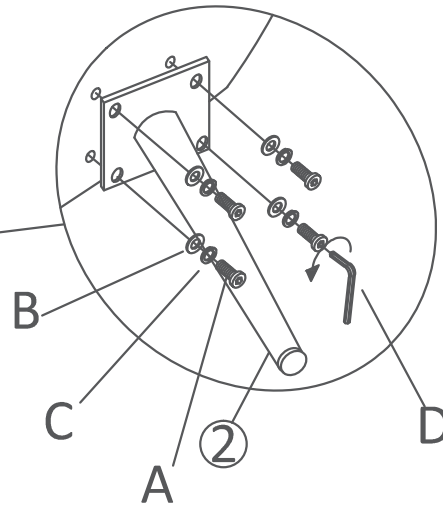
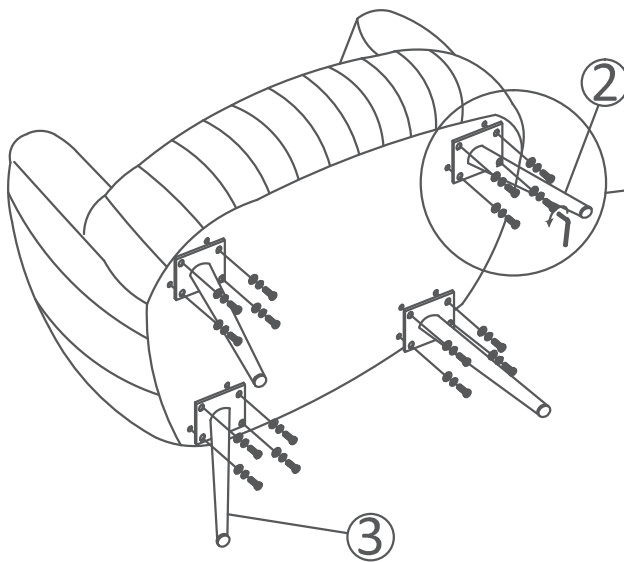

A M8x20 16x	B M8x19 16x	C M8x13 16x	D M5x40x100 1x
------------------------------	------------------------------	------------------------------	---------------------------------



1



- A M8x20
16x

- B M8x19
16x

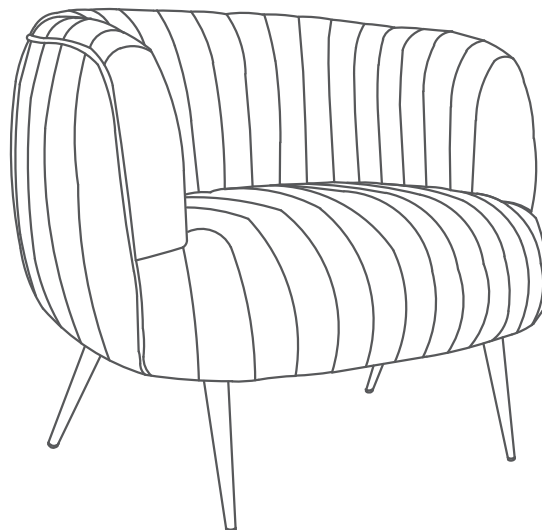
- C M8x13
16x

- D M5x40x100
1x

- 2 80x80xH230
2x

- 3 80x80xH230
2x

2



3

MAX
120KG

