

TYP 31

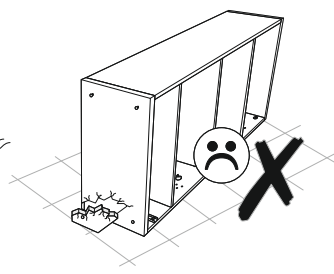

90 MIN

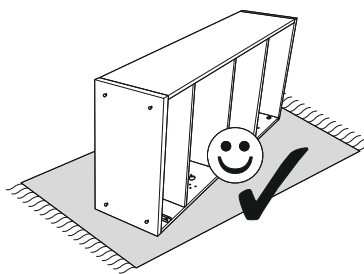

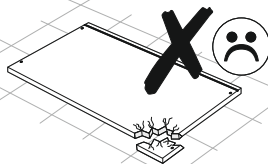
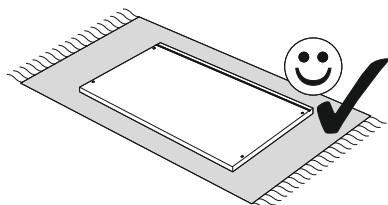
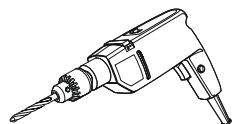
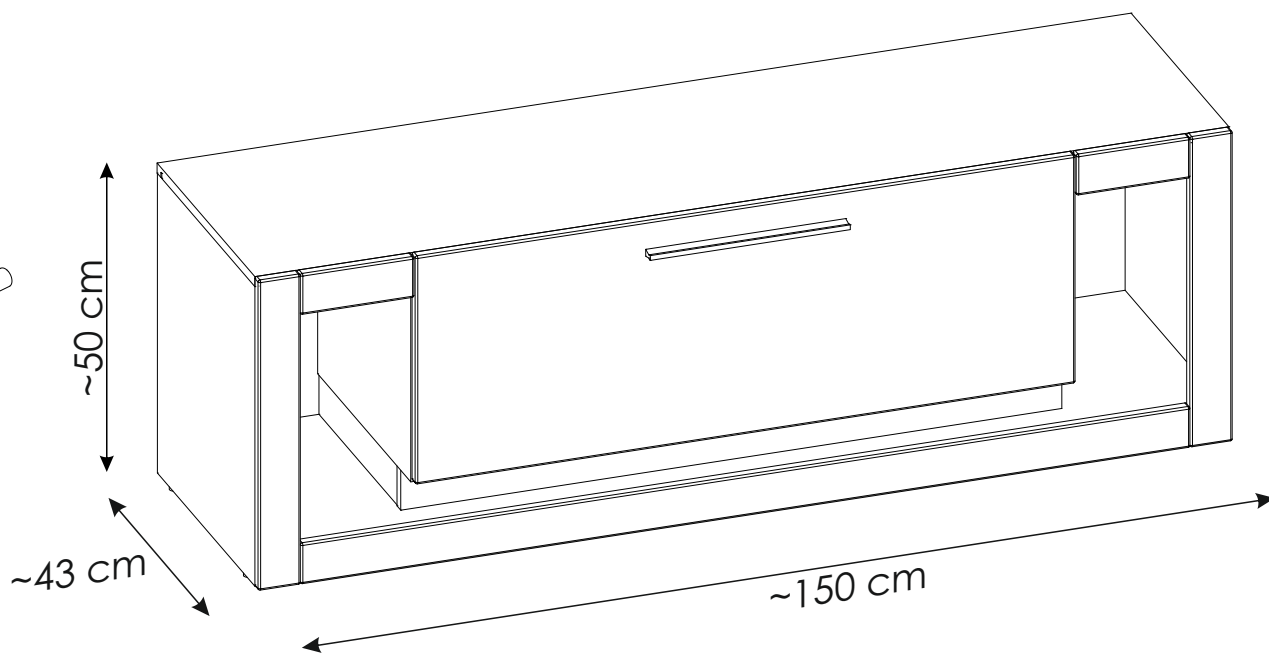
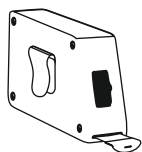
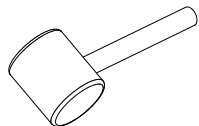
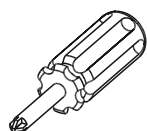
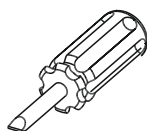
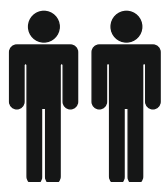
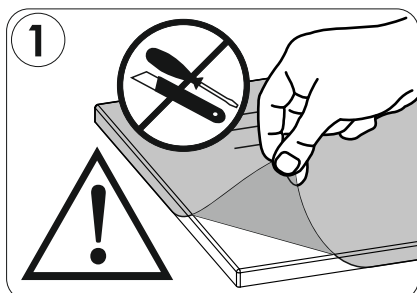

PL.

UWAGA! Mebel należy trwale zamocować do ściany, aby uniknąć ryzyka związanego z przewróceniem się mebla. W paczce nie ma śrub mocujących, ponieważ rodzaj mocowania należy odpowiednio dobrać do rodzaju ściany. Dobierz właściwe do Twojego rodzaju ściany.

D.

ACHTUNG! Um alle mit dem Umkippen des Möbels verbundenen Risiken auszuschließen, muss das Möbel fest an der Wand verankert werden. Beschläge für die Wandbefestigung sind nicht beige packt, da diese von der jeweiligen Wandbeschaffenheit abhängig sind. Bitte solche Befestigungsschläge wählen, die für die heimischen Wände geeignet sind.

FR.

ATTENTION! Ce meuble doit être fixé en permanence au mur pour éviter les risques de chute. Les vis de fixation ne sont pas livrées car le type de fixation doit être choisi en fonction du type de mur. Sélectionnez les fixations adaptées au mur.

I.

ATTENZIONE! Il mobile deve essere permanentemente fissato alla parete per evitare i rischi derivanti da un ribaltamento del mobile. La confezione non include le viti di fissaggio, in quanto il tipo di fissaggio deve essere scelto in base al tipo di parete. Utilizzare viti appropriate in base al materiale della parete.

HR.

NAPOMENA! Namještaj mora biti trajno pričvršćen za zid, kako bi se izbjegao rizik od njegovog prevrtanja. U paketu nema vijaka za pričvršćivanje, jer se vrsta montaže mora prilagoditi vrsti zida. Odaberite pravu vrstu prema Vašoj vrsti zida.

EN.

WARNING! To prevent this furniture from tripping over, fix it to the wall permanently. Fixing devices are not included since different wall materials require different types of fixing devices. Please make sure you chose the correct ones for your type of wall.

SK.

POZOR! Nábytok musí byť trvalo pripevnený k stene tak, aby sa zamedzilo riziku prevrátenia. Balík neobsahuje upevňovacie skrutky, pretože typ upevnenia je treba vybrať podľa typu steny. Vyberte typ vhodný pre Vašu stenu.

CZ.

POZOR! Nábytek je nutné pevně připevniť ke zdi, abychom se vyhnuli riziku spojenému s jeho převrnutím. Součástí balení nejsou připevňovací šrouby, protože způsoby připevnění je nutné zvolit podle druhu stěny. Vyberte správný pro Váš typ stěny.

RU.

ПРИМЕЧАНИЕ! Эту мебель необходимо всегда прикреплять к стене, чтобы избежать рисков, связанных с переворотом мебели. В пакете нет крепежных винтов, потому что тип крепления должен быть выбран в соответствии с типом стены. Выберите, пожалуйста, правильные винты к вашей стене.

RO.

ATENȚIE! Mobila trebuie ancorată permanent în perete pentru a evita riscul de răsturnare a mobilei. În pachet nu sunt incluse șuruburile de fixare, deoarece tipul de ancoraj trebuie ales în funcție de tipul de perete. Alegeți șuruburile potrivite pentru tipul Dvs. de perete.

TR.

DİKKAT! Devrilme riskini önlemek için mobilya duvara sabitlenmelidir. Sabitleme civataları pakete dahil değil, çünkü sabitleme tertibatının tipi duvara tipine uygun olarak seçilmelidir. Onu duvarınızın tipine göre seçiniz.

AR.

ملاحظة!

يجب تثبيت الأثاث بإحكام إلى الحائط أو الجدار لتجنب خطر إنقلابه. لا تحتوي العلبة على مسامير التثبيت، إذ إنه ينبغي إستعمال المسامير المخصصة لنوعية الحائط أو الجدار. اختر المسامير التي تناسب جدارك.

E.

¡ATENCIÓN! El mueble debe ser fijado permanentemente a la pared para evitar el riesgo relacionado con el vuelco del mueble. En el paquete no hay tornillos de fijación, ya que se debe elegir el tipo de fijación adecuado para el tipo de pared. Elija el apropiado para su tipo de pared.

CN.

注意！本家具需要固定在墙上以免倒塌。箱子里没有安装螺钉。因为安装方式需要根据墙的类型调整。请按照您的墙类型选择合适的安装方式。

SLO.

POZOR! Pohištvo trajno pritrdite na steno, da preprečite tveganje, da se prevrne. V paketu ni pritrdilnih vijakov, saj je treba način pritrditve ustrezno izbrati glede na vrsto stene. Izberite način, ki je ustrezen za vašo steno.

HU.

FIGYELEM! Rögzítse a bútorokat a falhoz, hogy elkerülje a bútor felborulásának kockázatát. A készletben nem találhatóék rögzítőcsavarok, mivel a rögzítés típusa a fal típusától függ. Válassza ki a fal típusának megfelelő kötőelemeket.





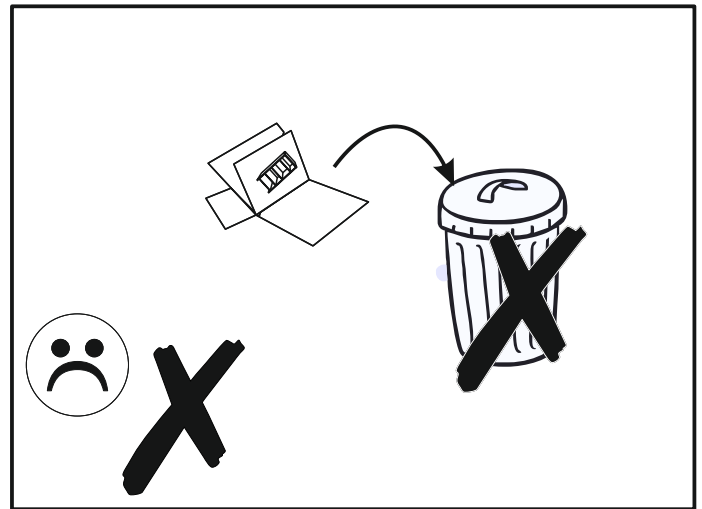







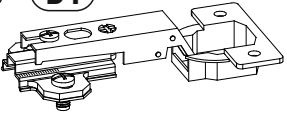

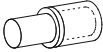

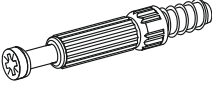
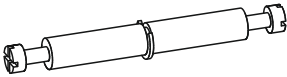
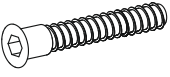
NL.

OPMERKING! De meubelen moeten permanent aan de muur worden bevestigd om te voorkomen dat de meubelen kantelen. Er zitten geen bevestigingsschroeven in het pakket, omdat het type bevestiging moet worden gekozen op basis van het type muur. Kies de juiste voor uw type muur.

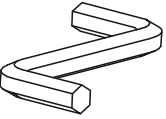
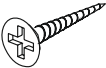

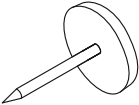
TYP31

MM

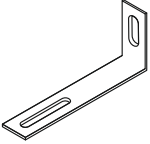
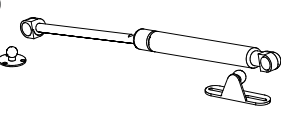
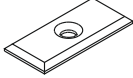
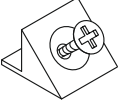
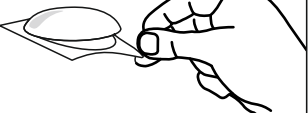
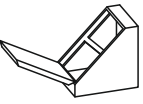
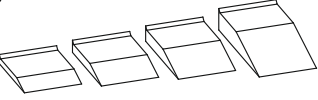
A1 8 x 35 mm x42 	A2 8 x 45 mm x4 	B0 + B1 x4 
C1 4 x 13 mm x6 	D2 x8 	E0 x20 
E1 15 x 12 mm x40 	F1 6 x 34 mm x32 	F3 7 x 58 mm x4 
G1 7 x 50 mm x8 	H1 L - 308 mm x1 	I2 4 x 16 mm x2 
I6 3,5 x 27 mm x2 	M x1 	N1 3 X 16 mm x20 
N2 3,5 x 16 mm x20 	O2 x4 	O2B ø10 x8 
O9 x2 	P4 x2 ø8 	Q9 x2 
PB x2 	R1 x6 	R4 x6 
R8 x2 	W x6 	Z x1 

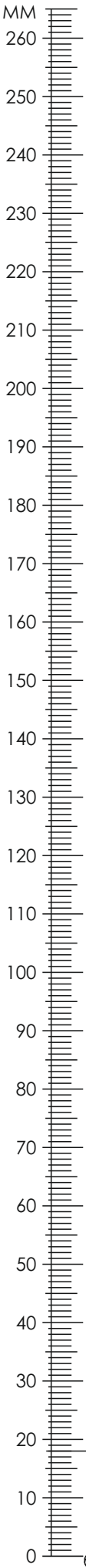
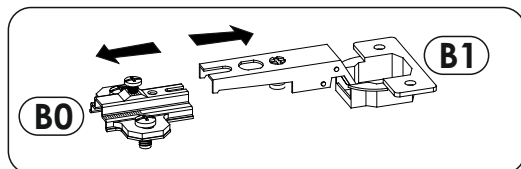

TYP31

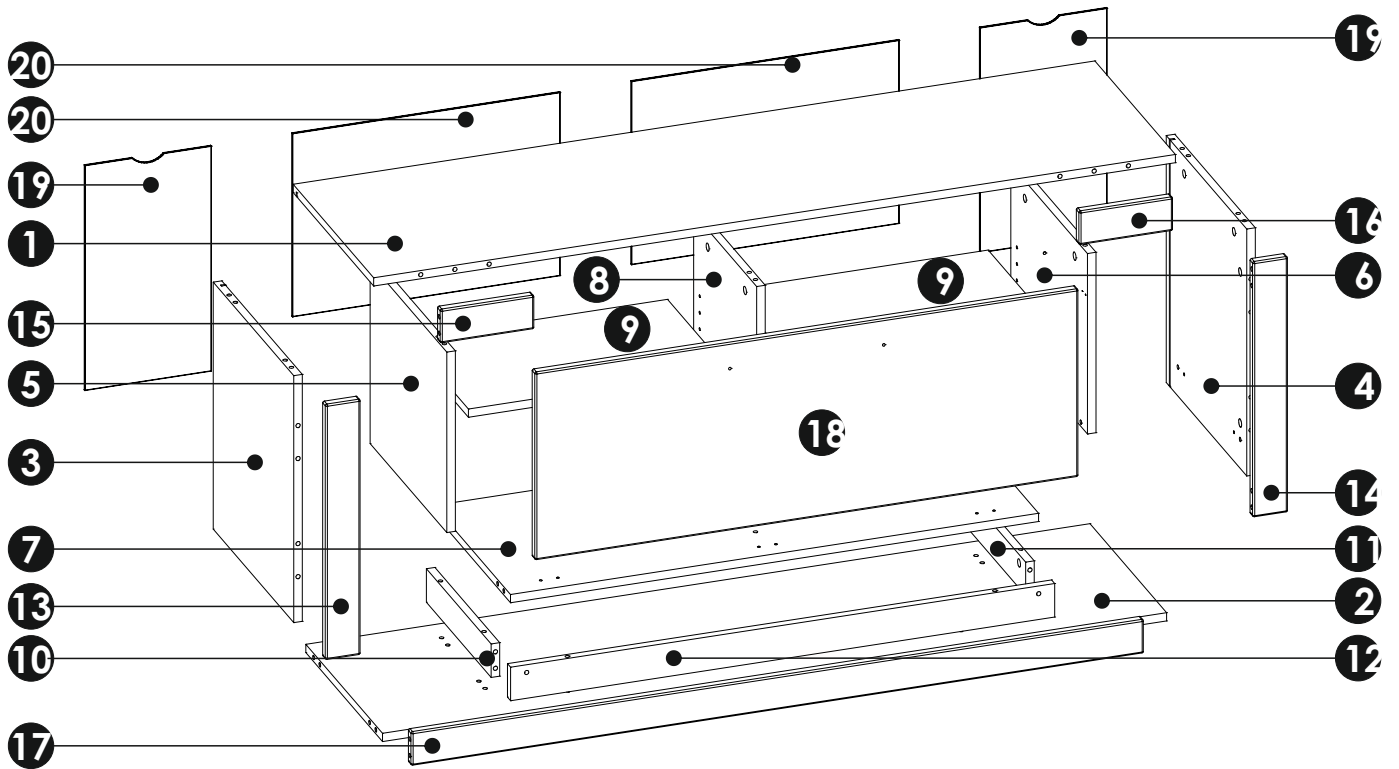
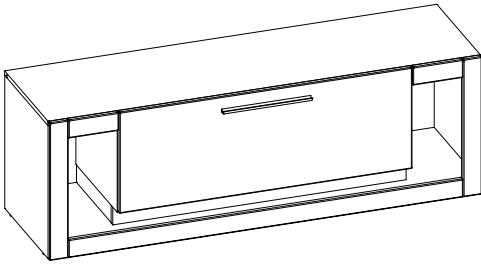



1	1500	414	16	x1	2/2
2	1467	394	16	x1	2/2
3	479	414	16	x1	1/2
4	479	414	16	x1	1/2
5	350	394	16	x1	1/2
6	350	394	16	x1	1/2

7	988	394	16	x1	1/2
8	334	324	16	x1	1/2
9	485	309	16	x2	1/2
10	333	65	16	x1	2/2
11	333	65	16	x1	2/2
12	1018	65	16	x1	2/2
13	495	65	16	x1	2/2

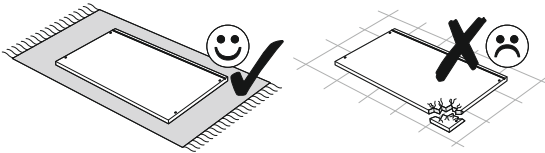
14	495	65	16	x1	2/2
15	175	65	16	x1	2/2
16	175	65	16	x1	2/2
17	1370	65	16	x1	2/2
18	1016	364	16	x1	1/2
19	436	236	3	x2	1/2
20	355	500	3	x2	1/2





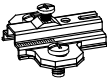

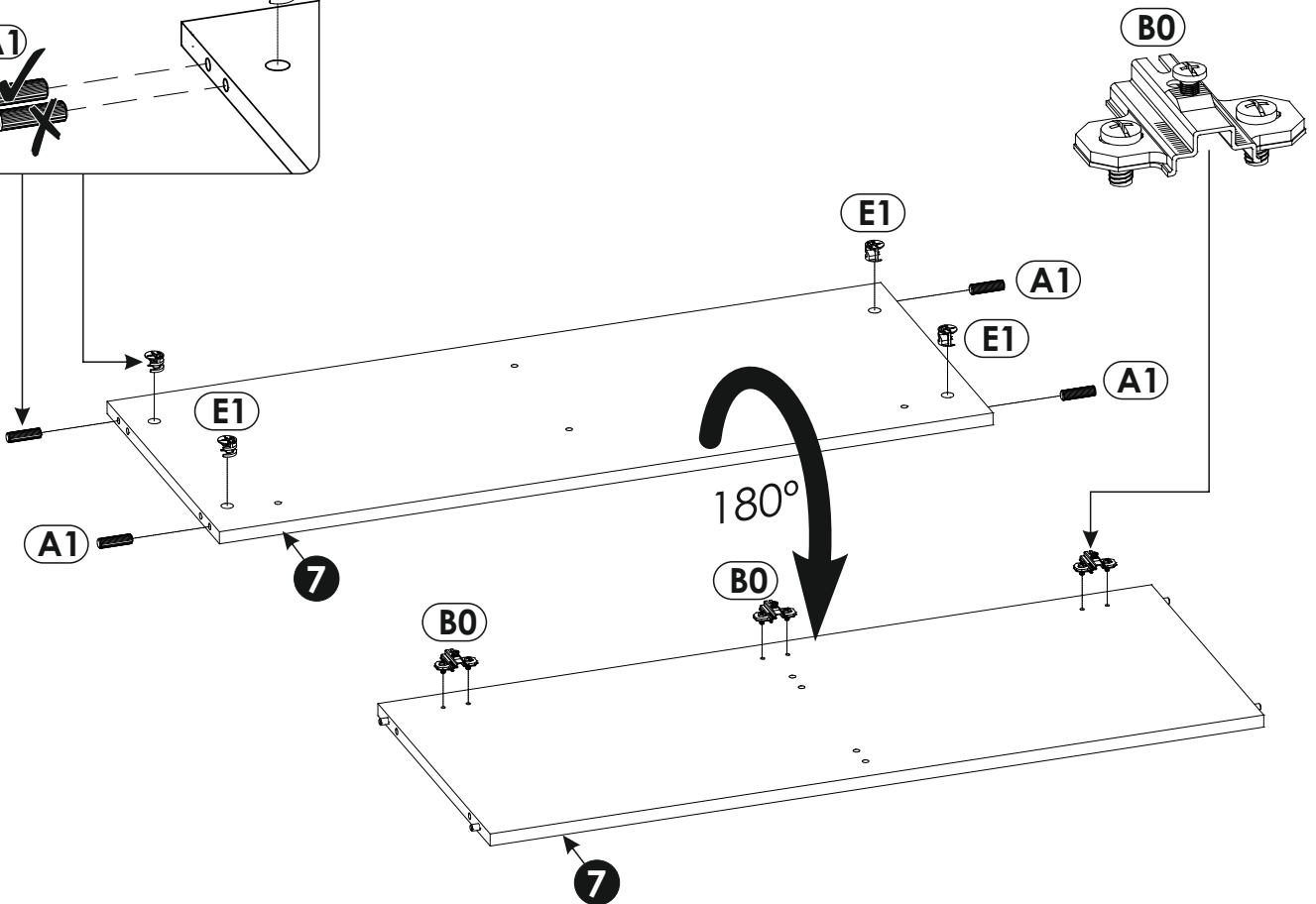
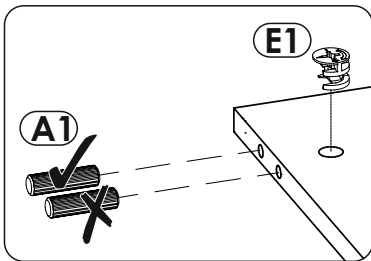
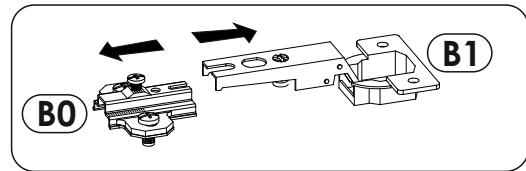
- A1**  8 x 35 mm
- A2**  8 x 45 mm

- | | | | | | |
|---|----|--|----|--|----|
| A1
8 x 35 mm
 | x4 | E1
15 x 12 mm
 | x4 | B0
 | x5 |
|---|----|--|----|--|----|

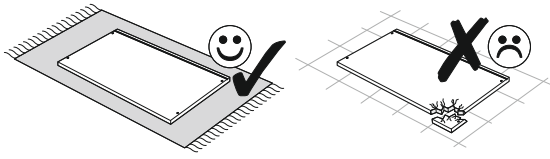

2 ▶

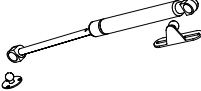

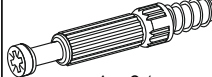
A1 x4  8 x 35 mm	PB x1 	E1 x2  15 x 12 mm	F1 x2  6 x 34 mm
---	--	--	---

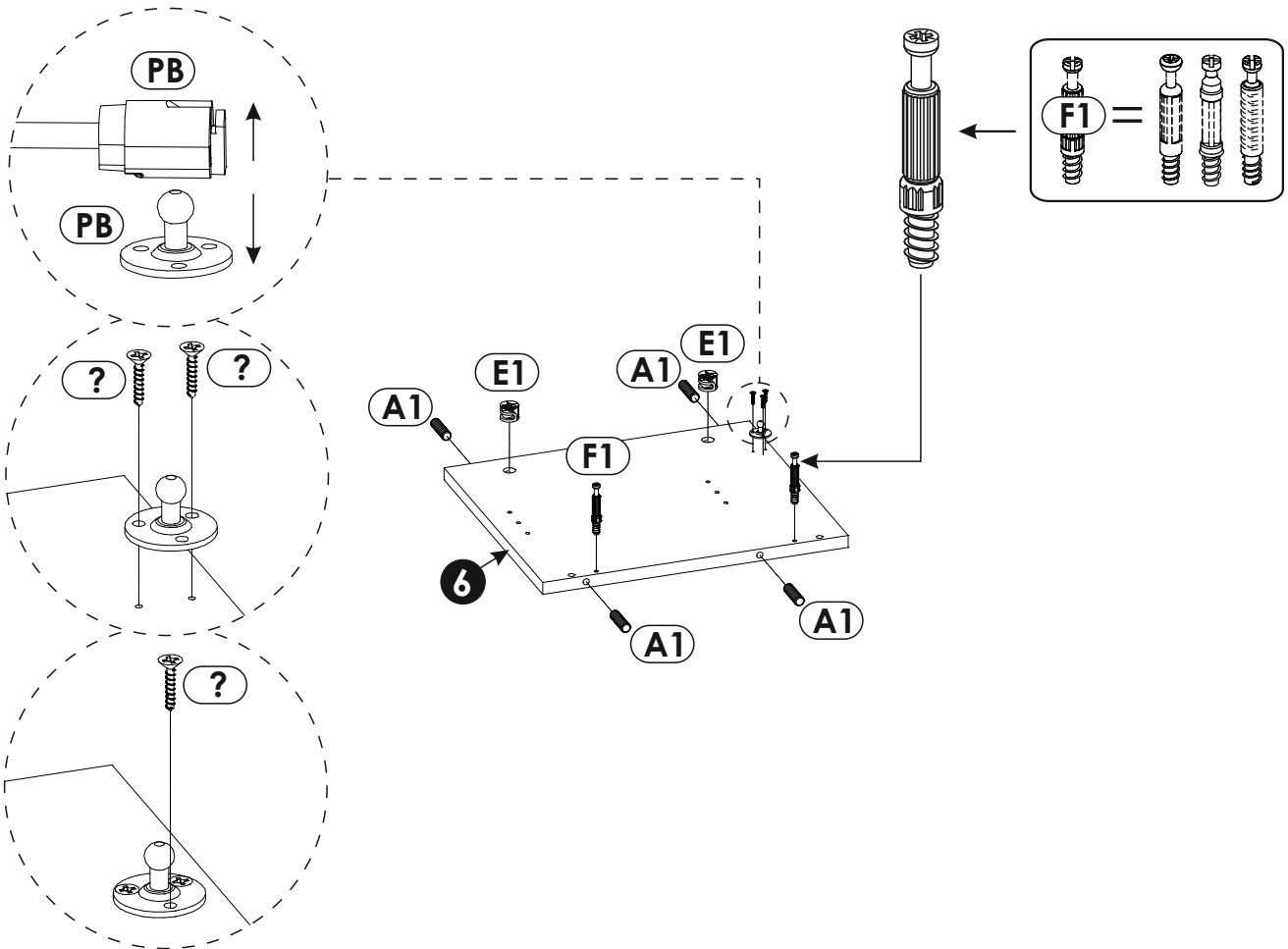

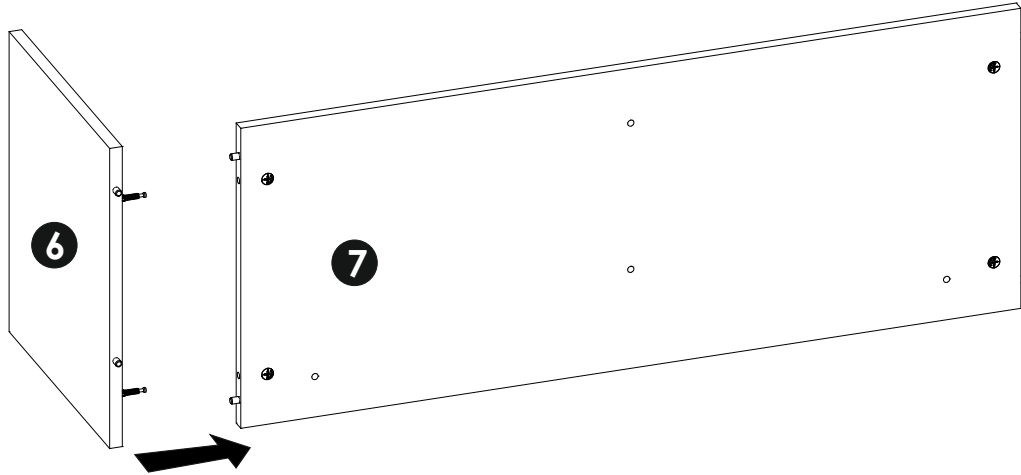
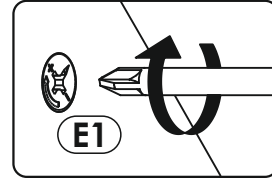
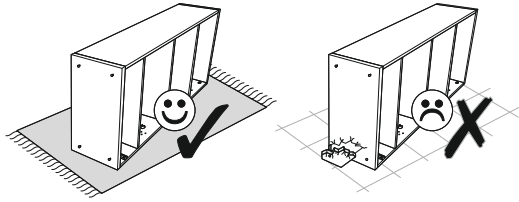

3 ▶

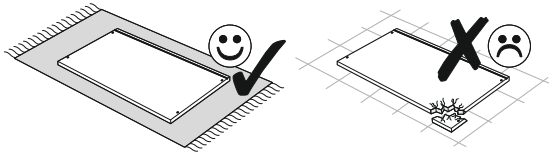

4 ▶

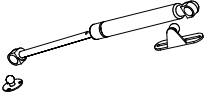

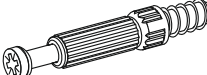
A1	x4	PB	x1	E1	x2	F1	x2
							
8 x 35 mm				15 x 12 mm		6 x 34 mm	

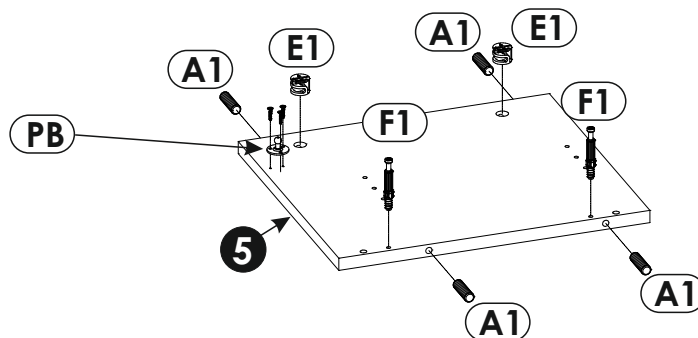

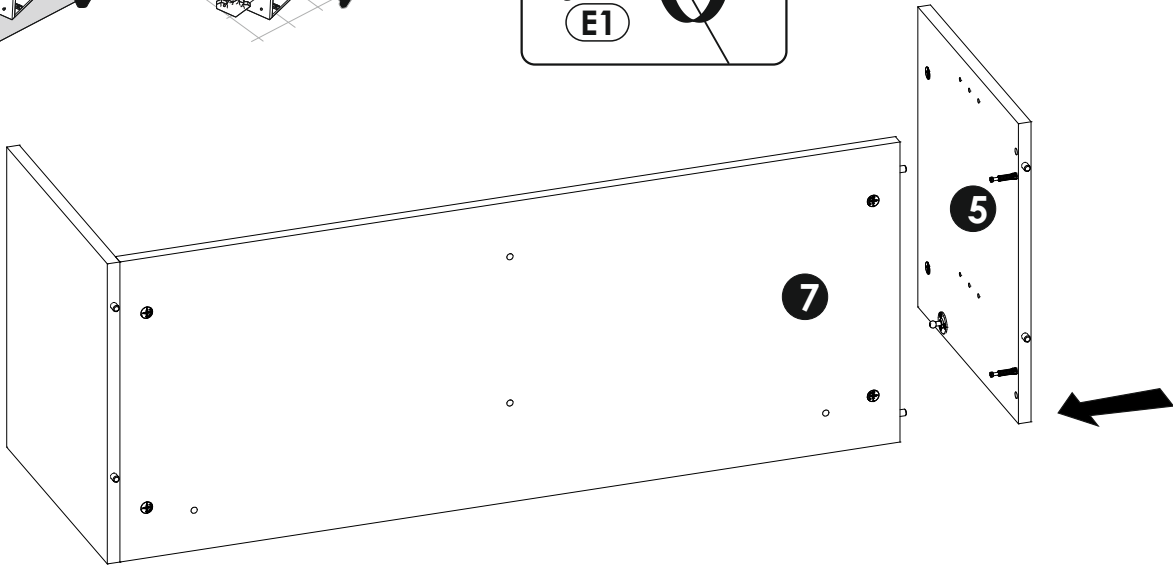
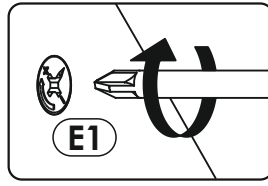
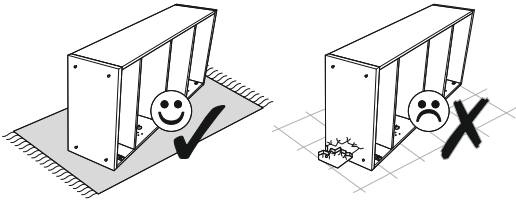

5 ▶

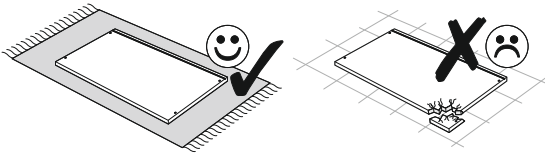

6 ▶



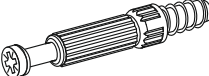

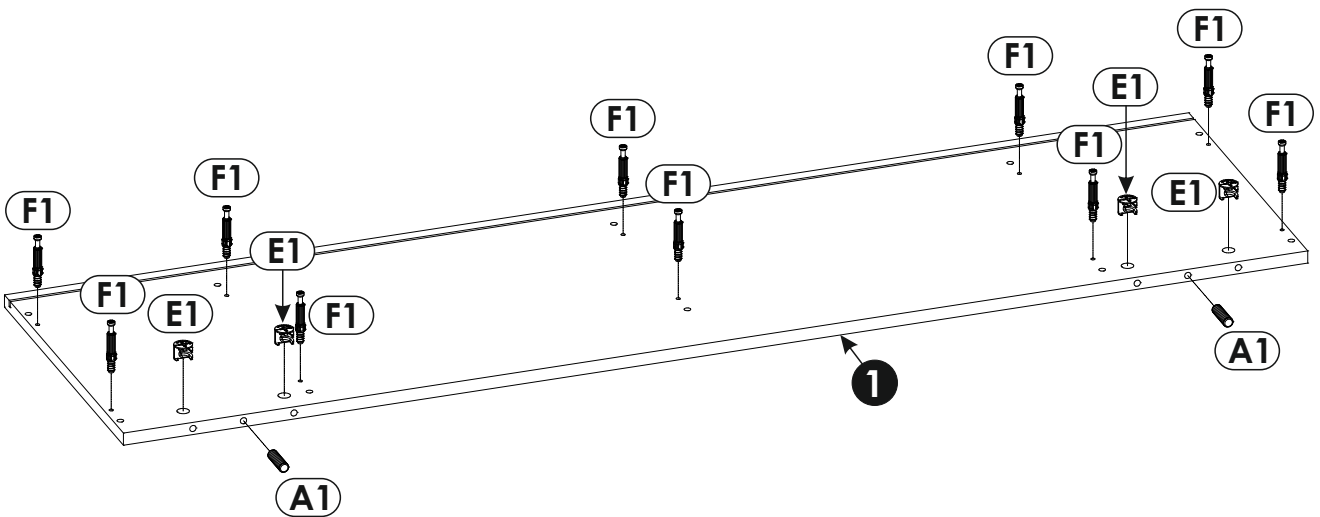
A1	x2	E1	x4	F1	x10
					
8 x 35 mm		15 x 12 mm		6 x 34 mm	

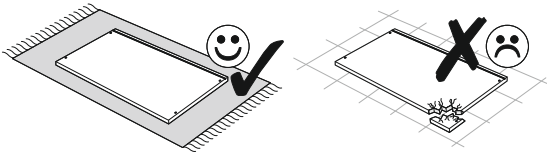

7 ▶



A1	x4	E1	x2
			
8 x 35 mm		15 x 12 mm	

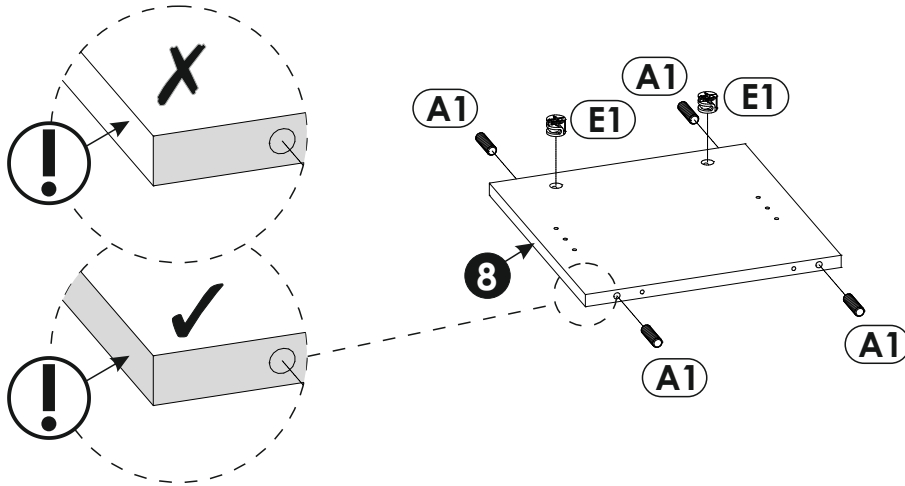

8 ▶

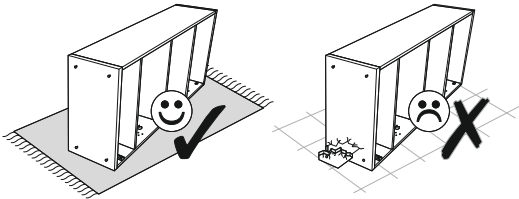

E0	x2
	

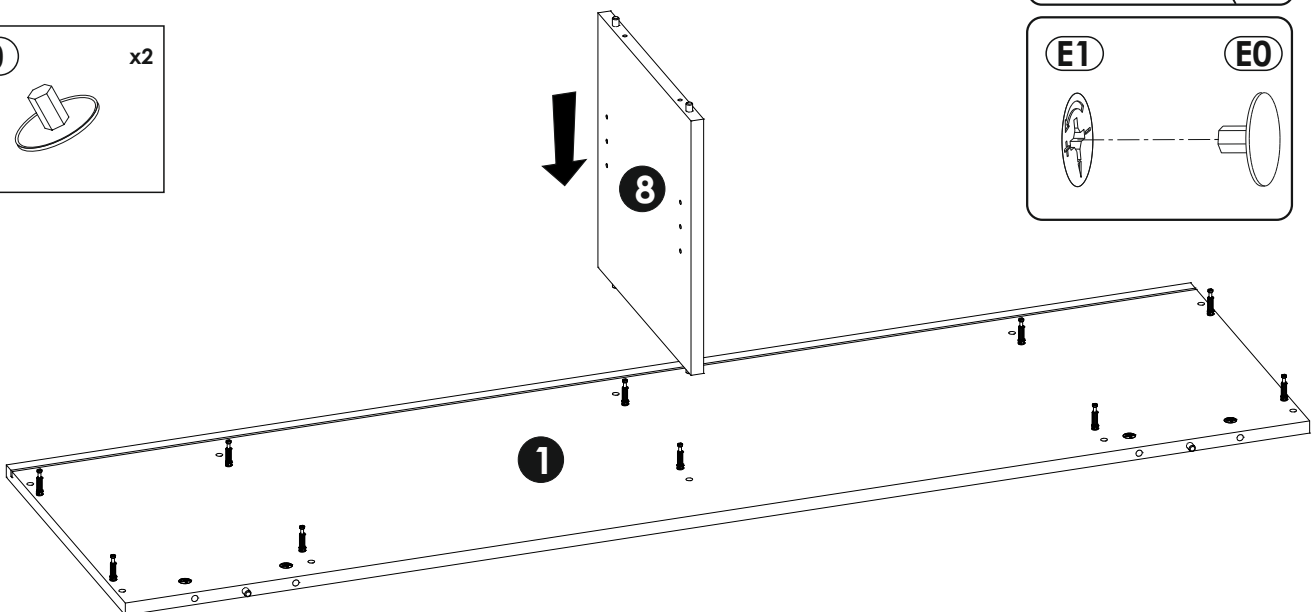
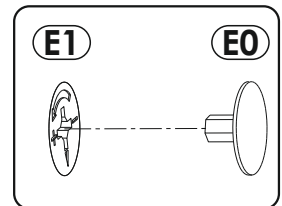
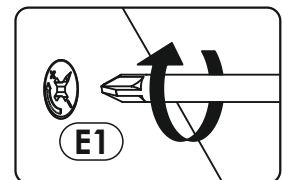

9 ▶

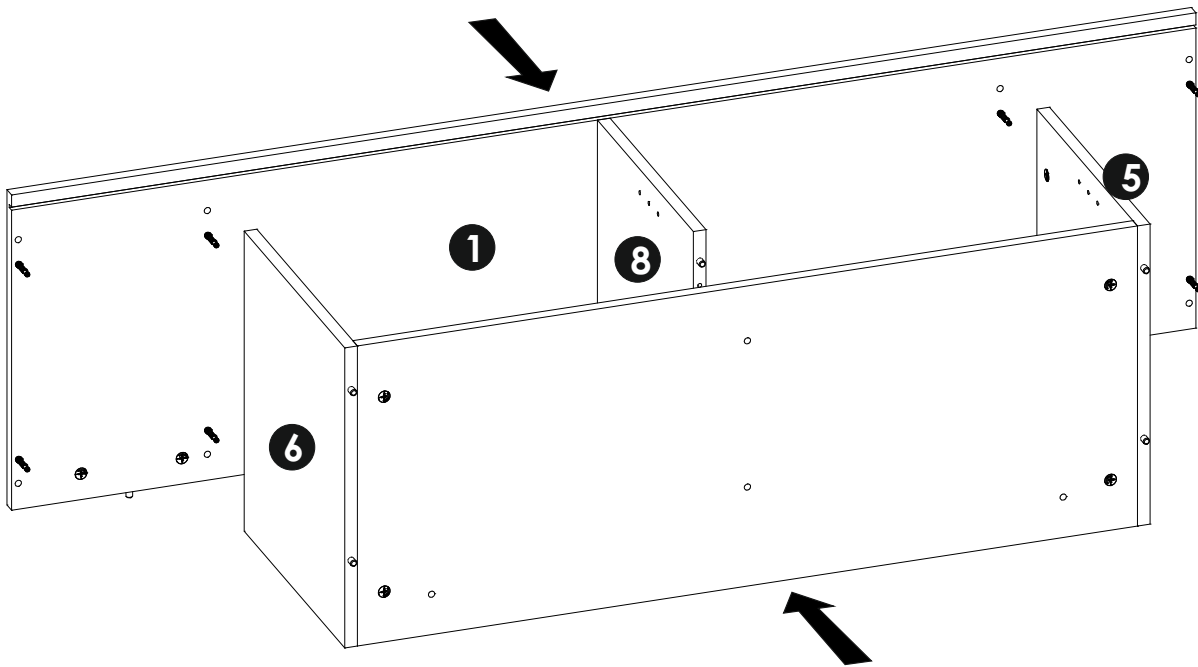
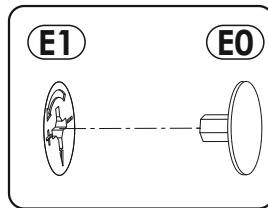
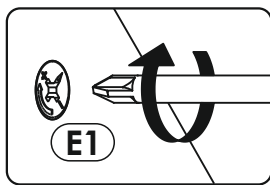
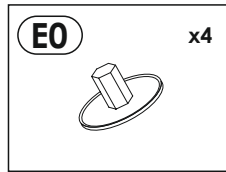
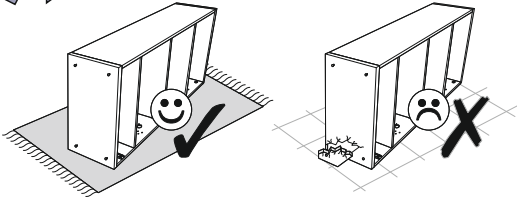

10 ▶

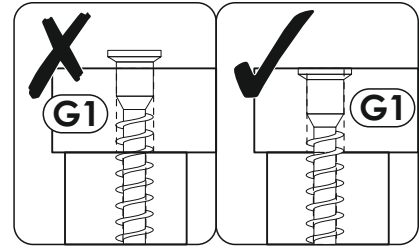
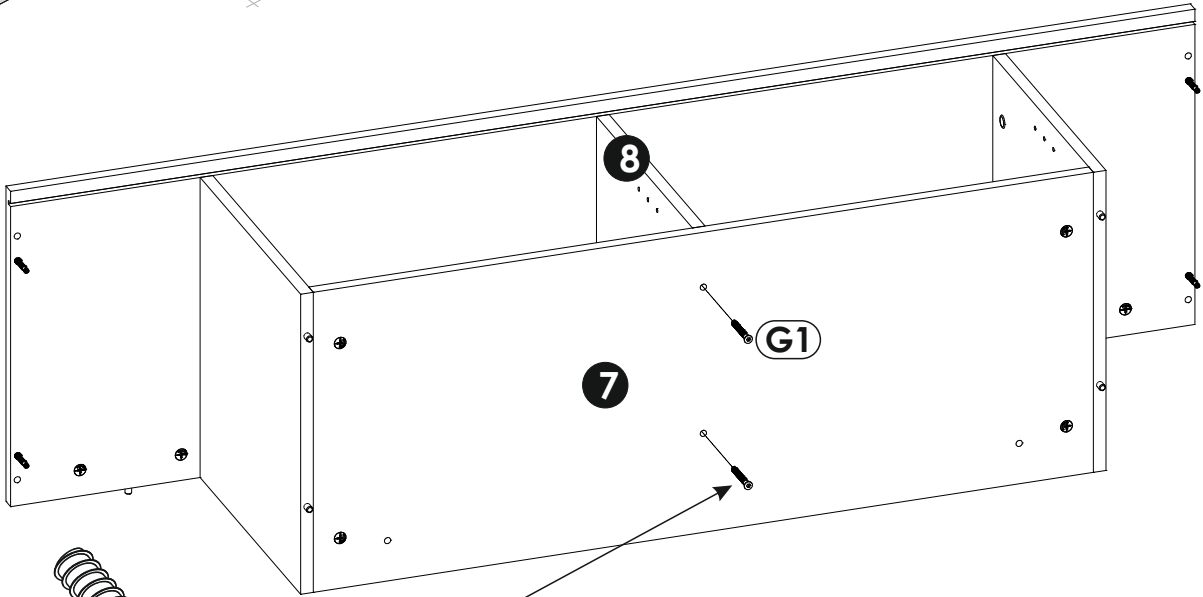
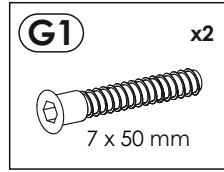
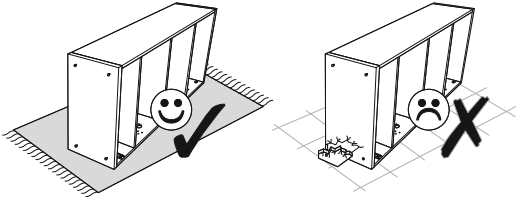

11 ▶

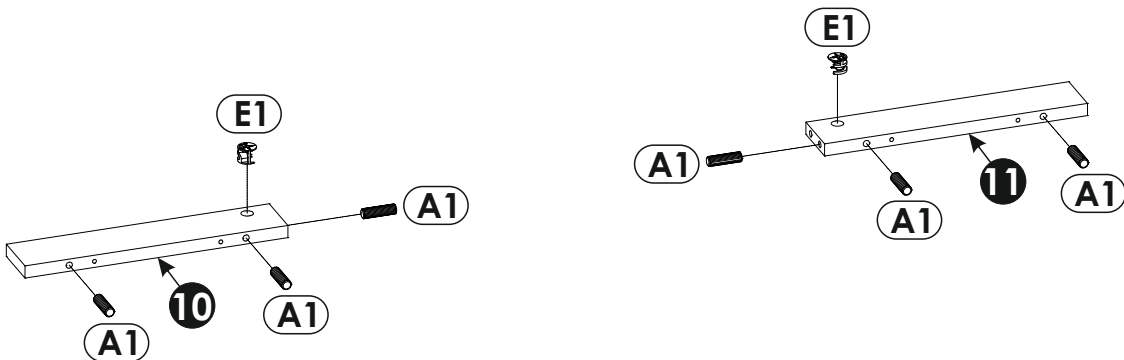
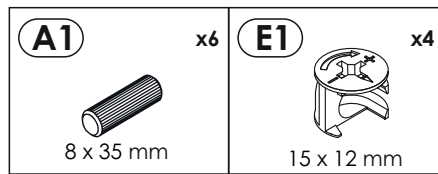
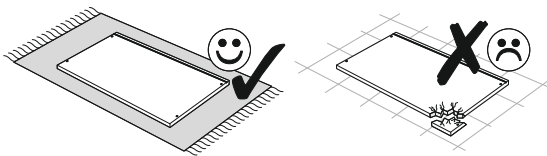

12 ▶

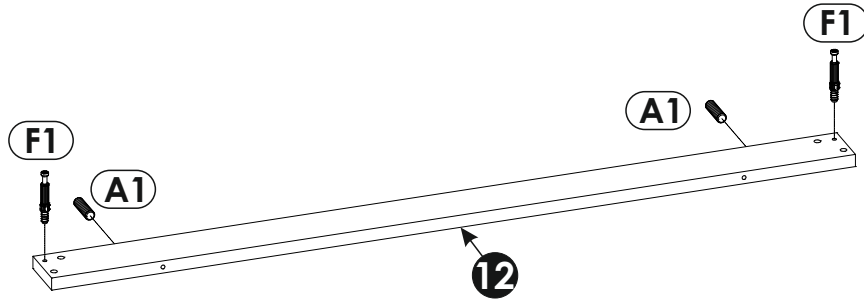
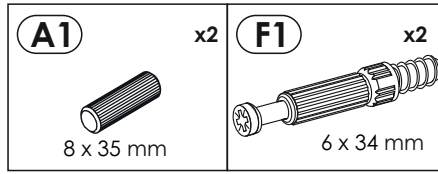
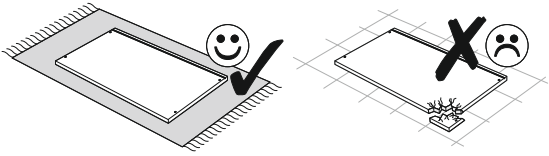

13 ▶

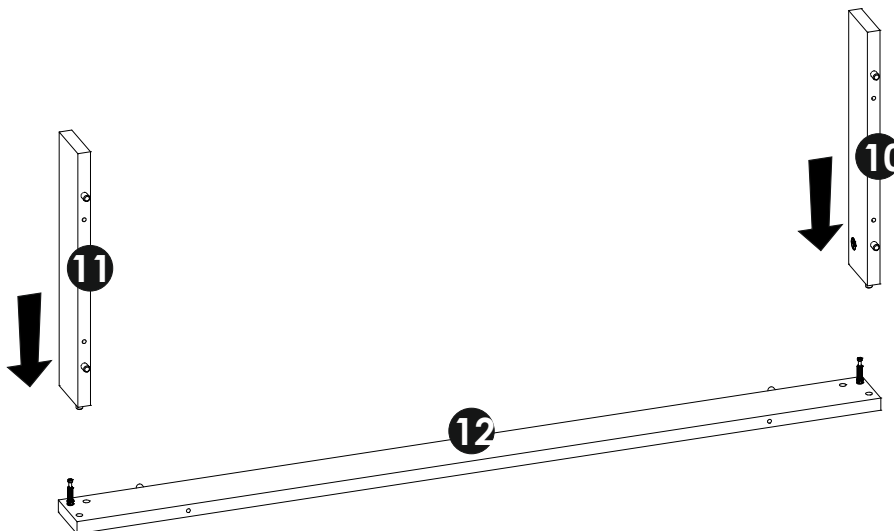
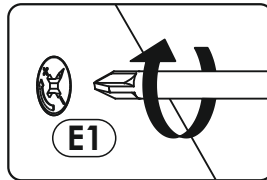
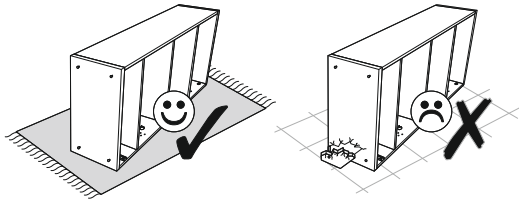

14 ▶

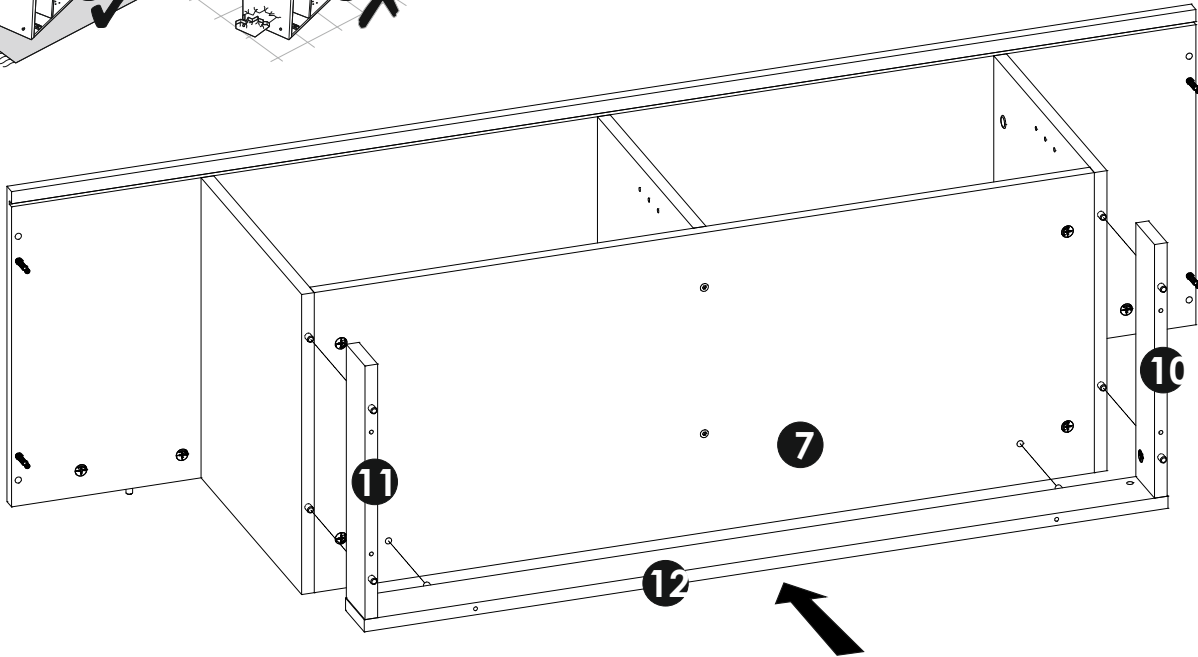
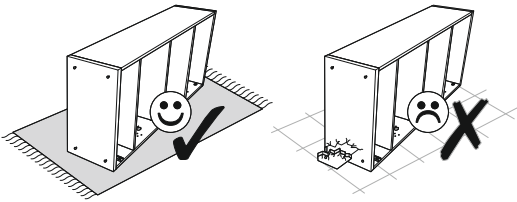

15 ▶

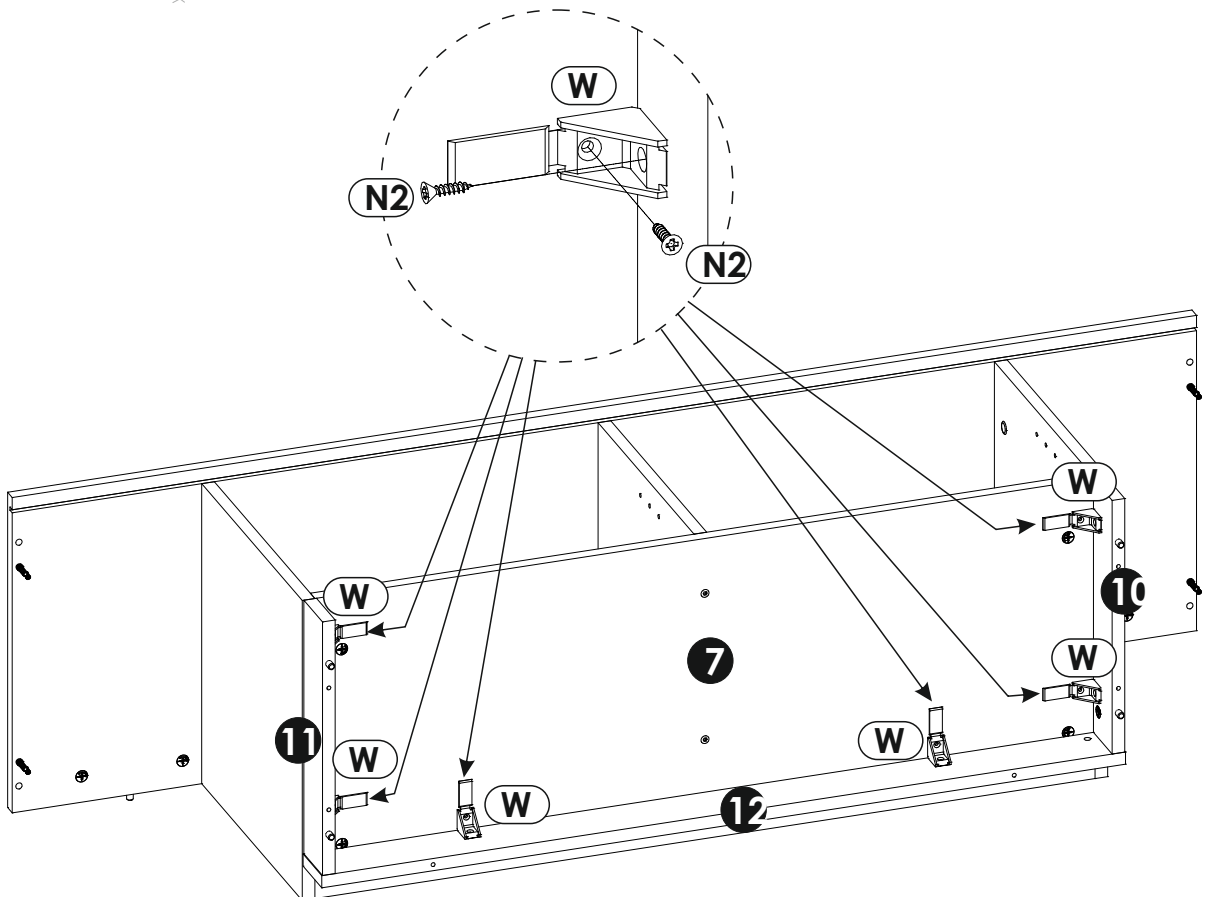
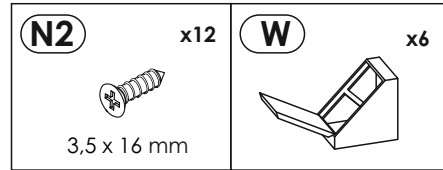
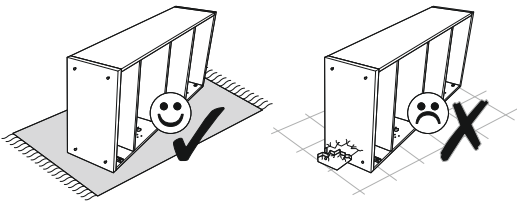

16 ▶

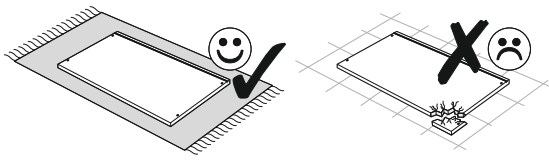

A1 8 x 35 mm x4	E1 15 x 12 mm x4	F1 6 x 34 mm x2
O2 x2	O2B ø10 x2	

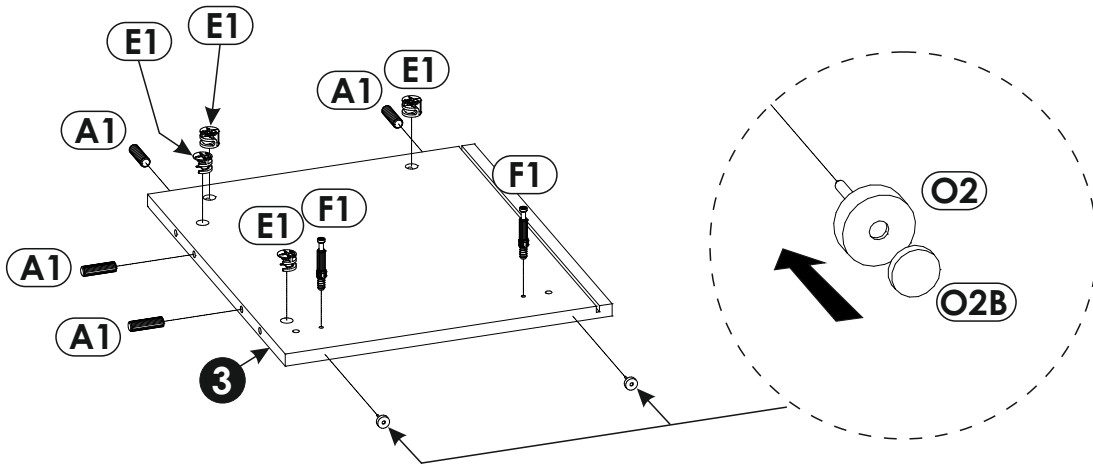

17 ▶

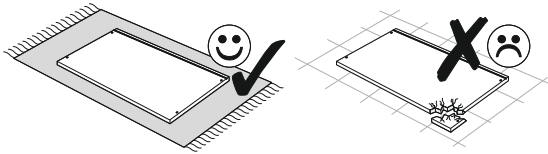

A1 8 x 35 mm x4	E1 15 x 12 mm x8
------------------------------	-------------------------------

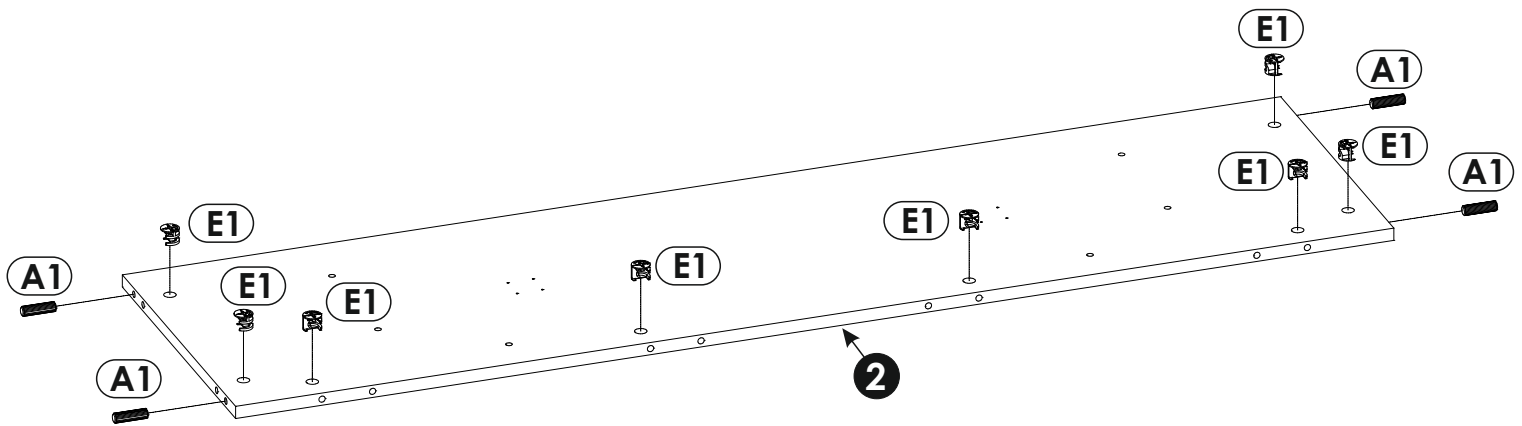



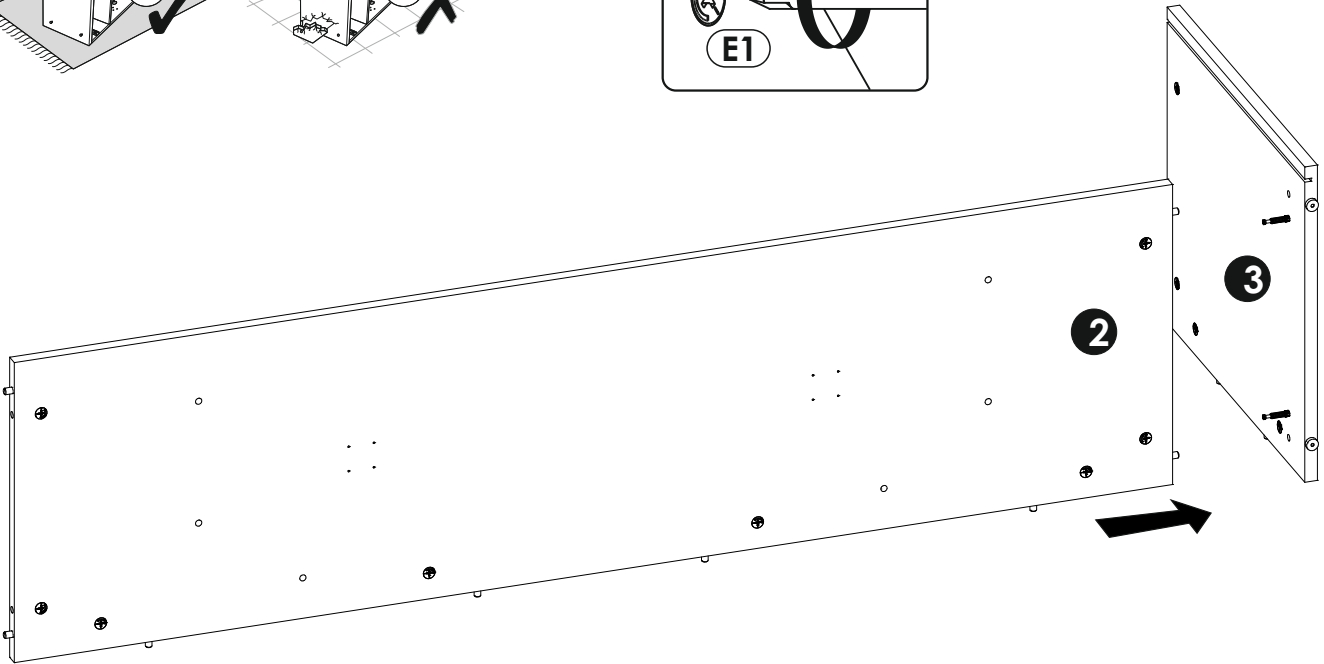
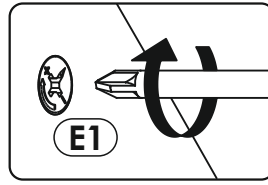
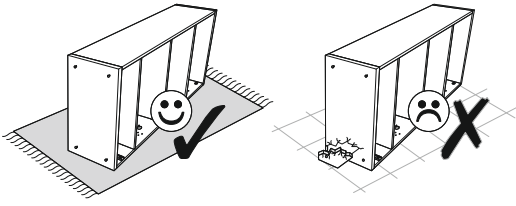

18 ▶

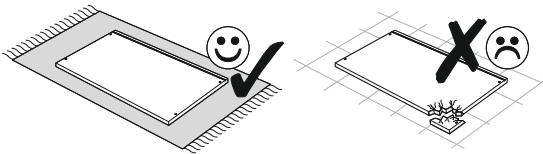

19 ▶

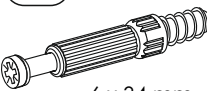

A1	x4	E1	x4	F1	x2	O2	x2	O2B	x2
									
8 x 35 mm		15 x 12 mm		6 x 34 mm				ø10	

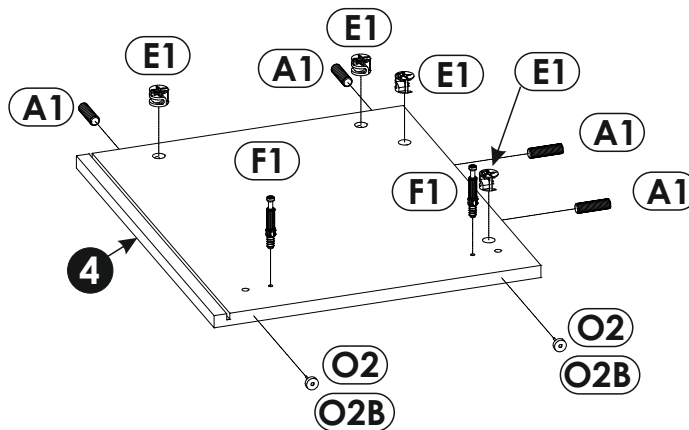

20 ▶

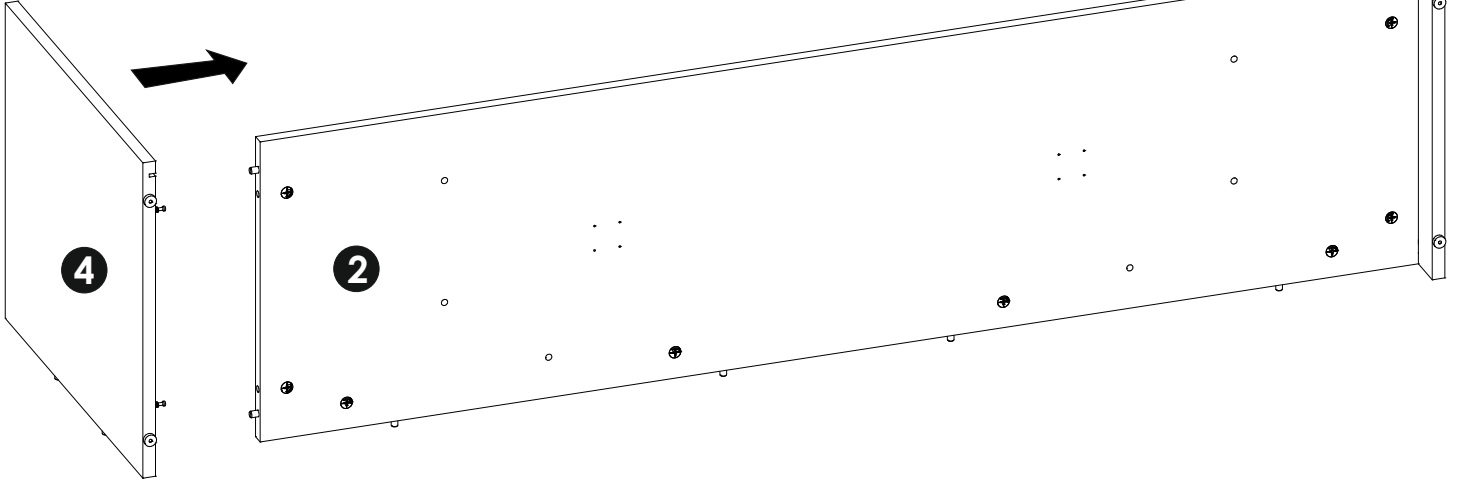
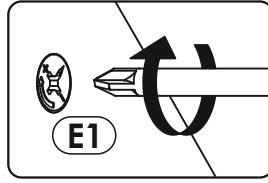
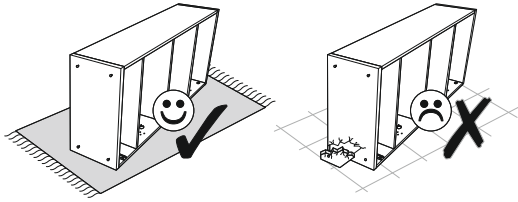

21 ▶

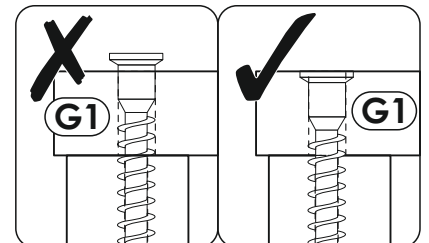
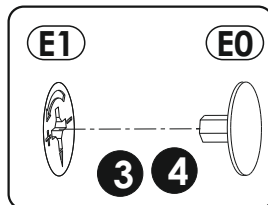
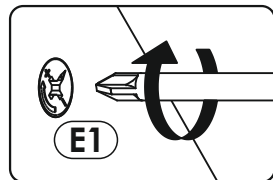
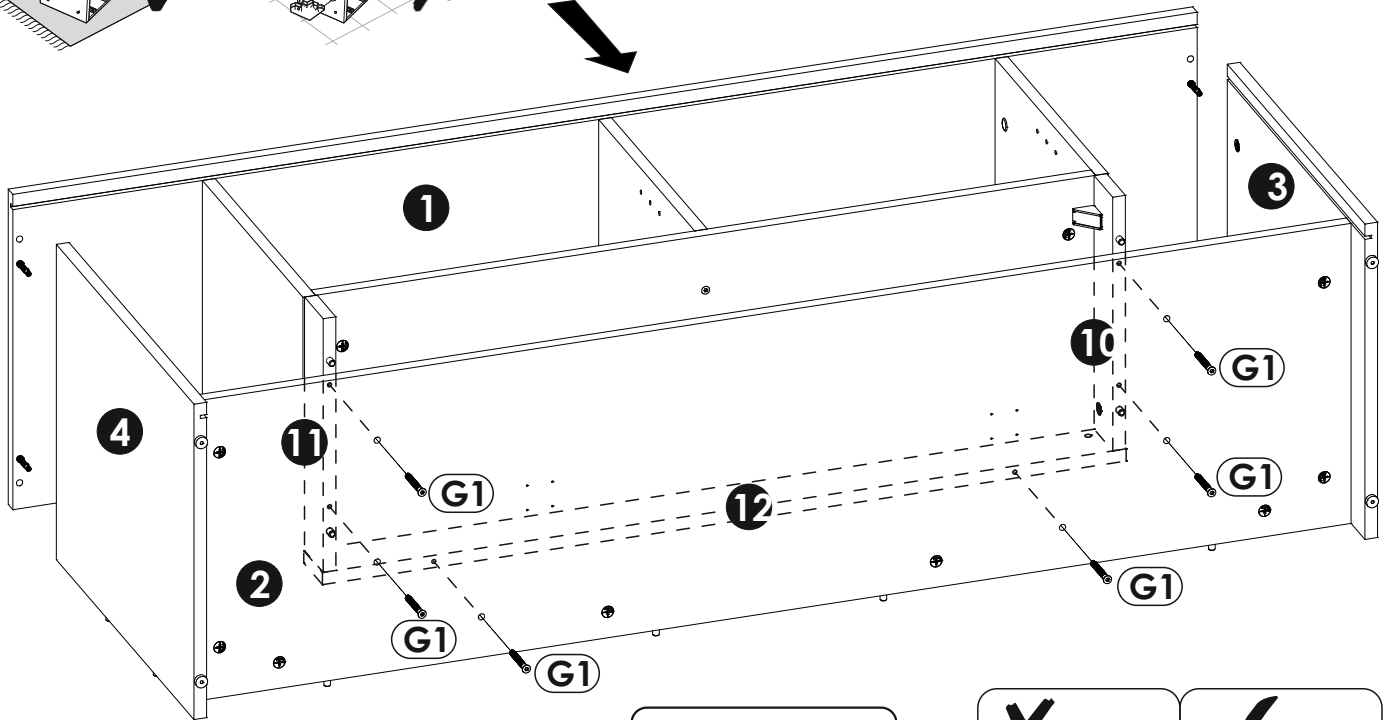
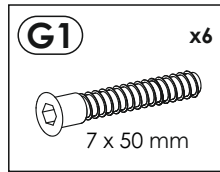
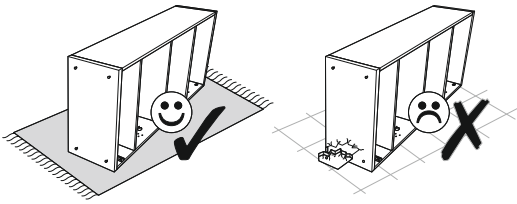

22 ▶

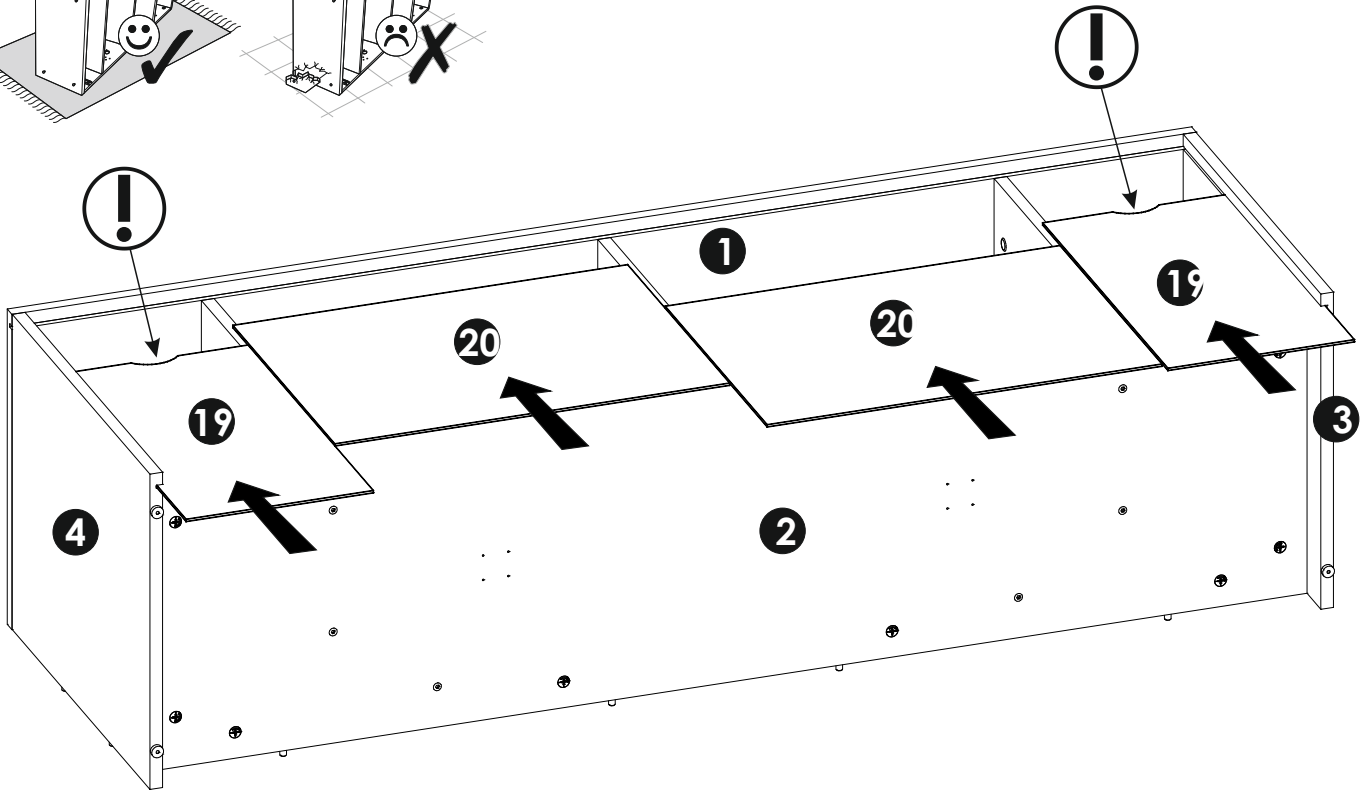
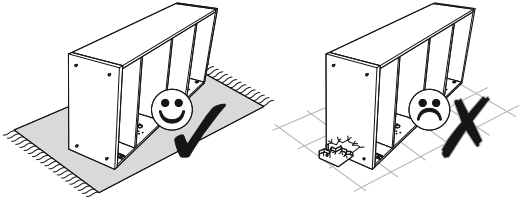

23 ▶

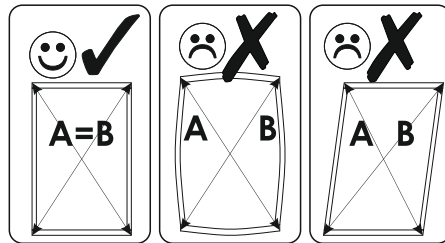
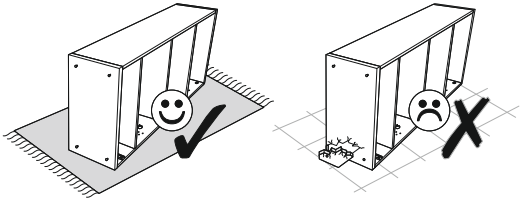

A=B

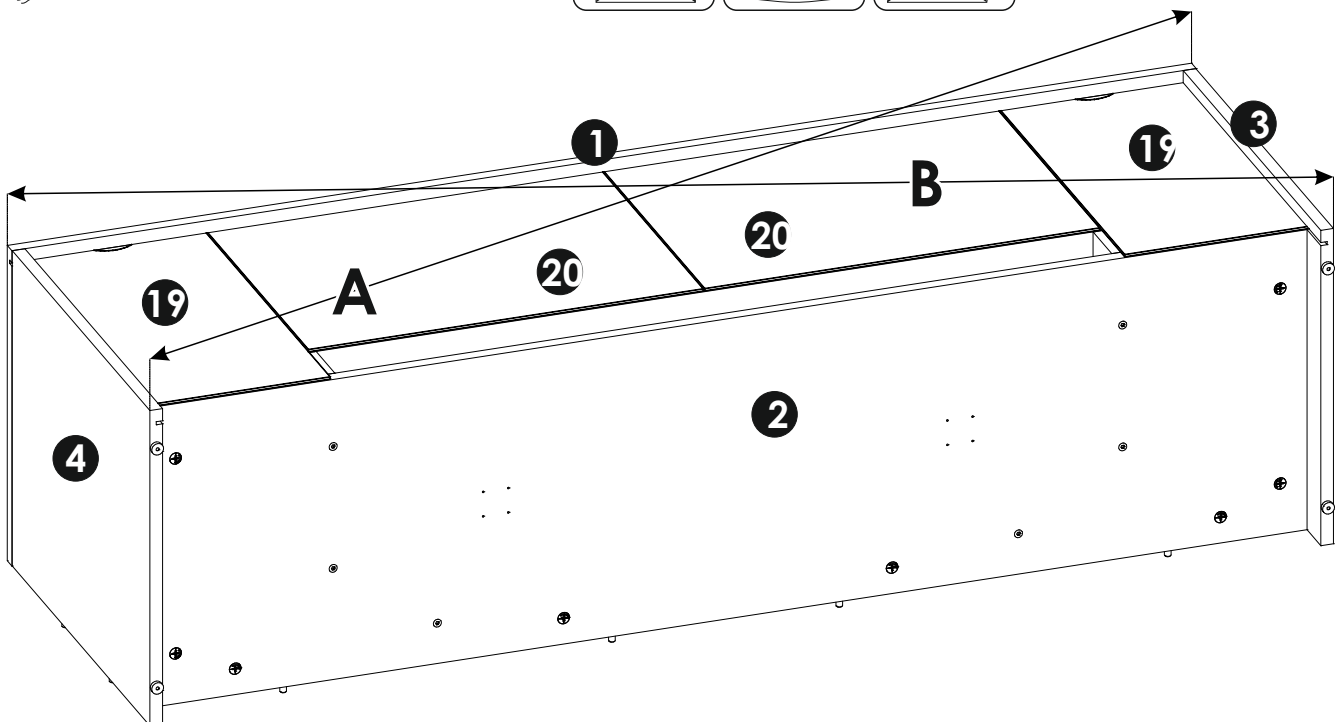

24 ▶

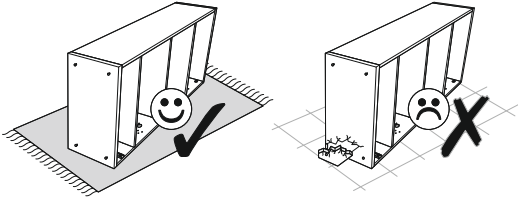

N2 x8 3,5 x 16 mm	N1 x18 3 X 16 mm	O9 x2
O2B x4 ø10	R1 x6	R4 x12

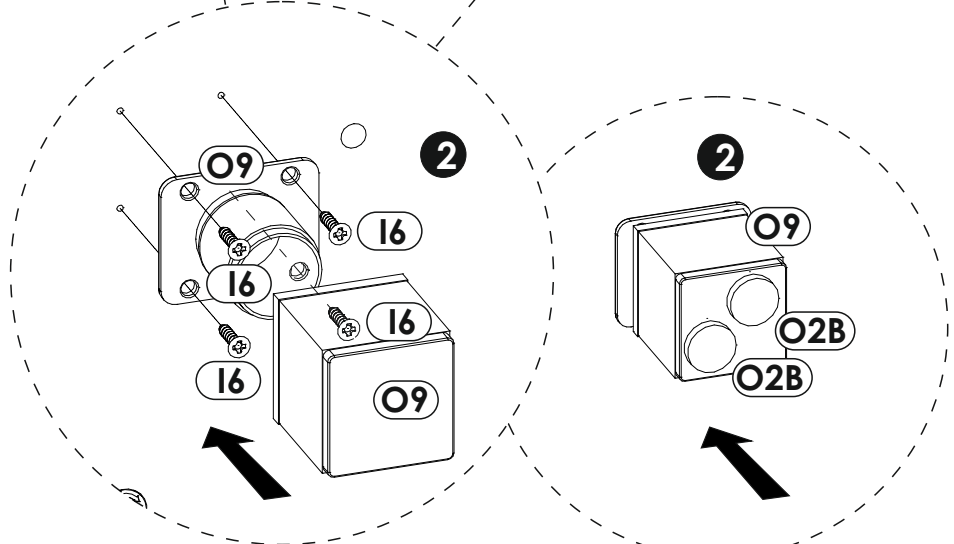
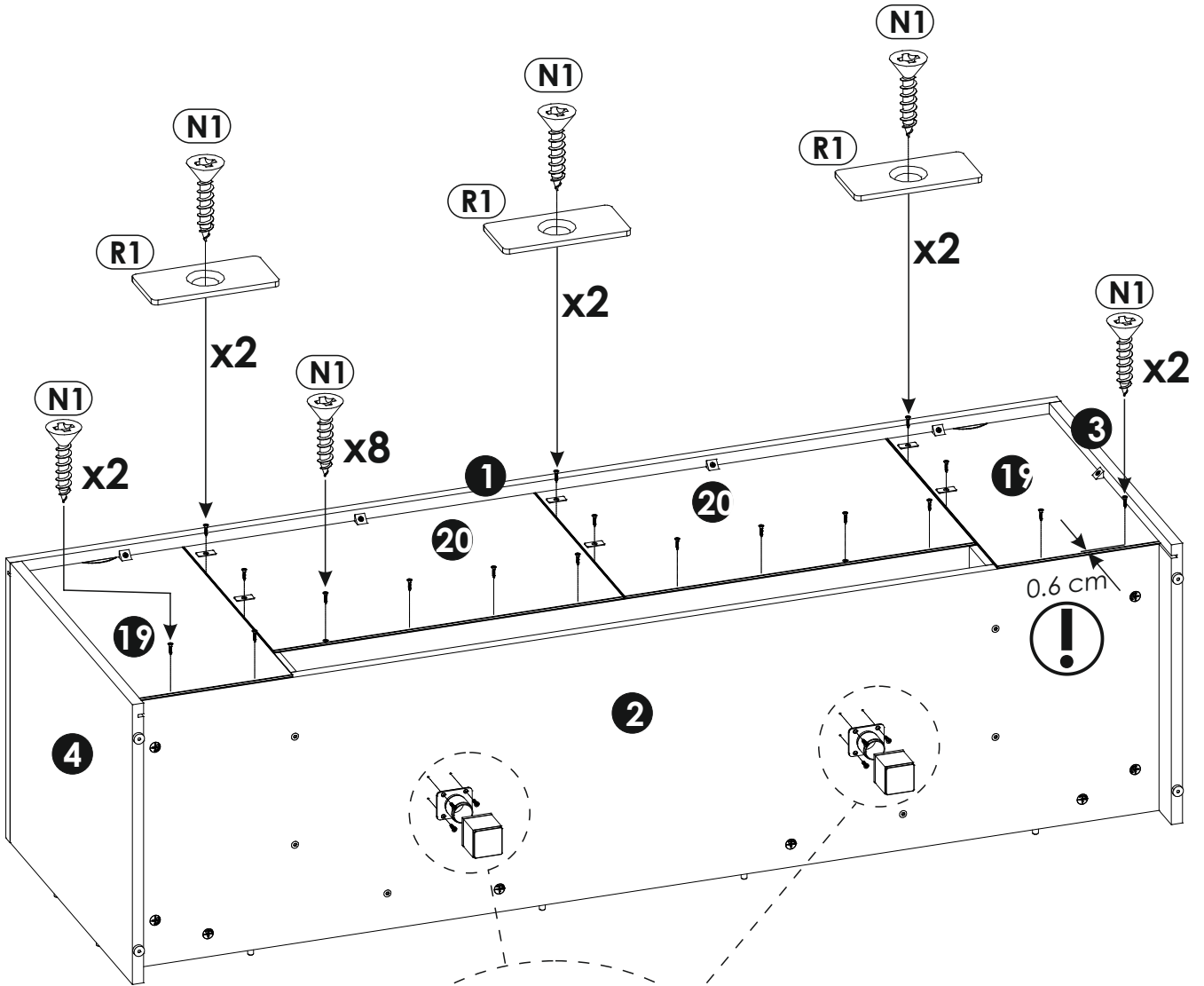

25 ▶

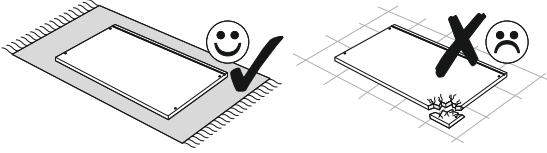

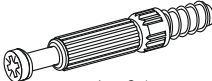
E1	x8	F1	x12
			
15 x 12 mm		6 x 34 mm	

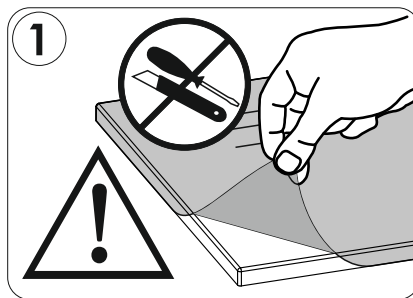
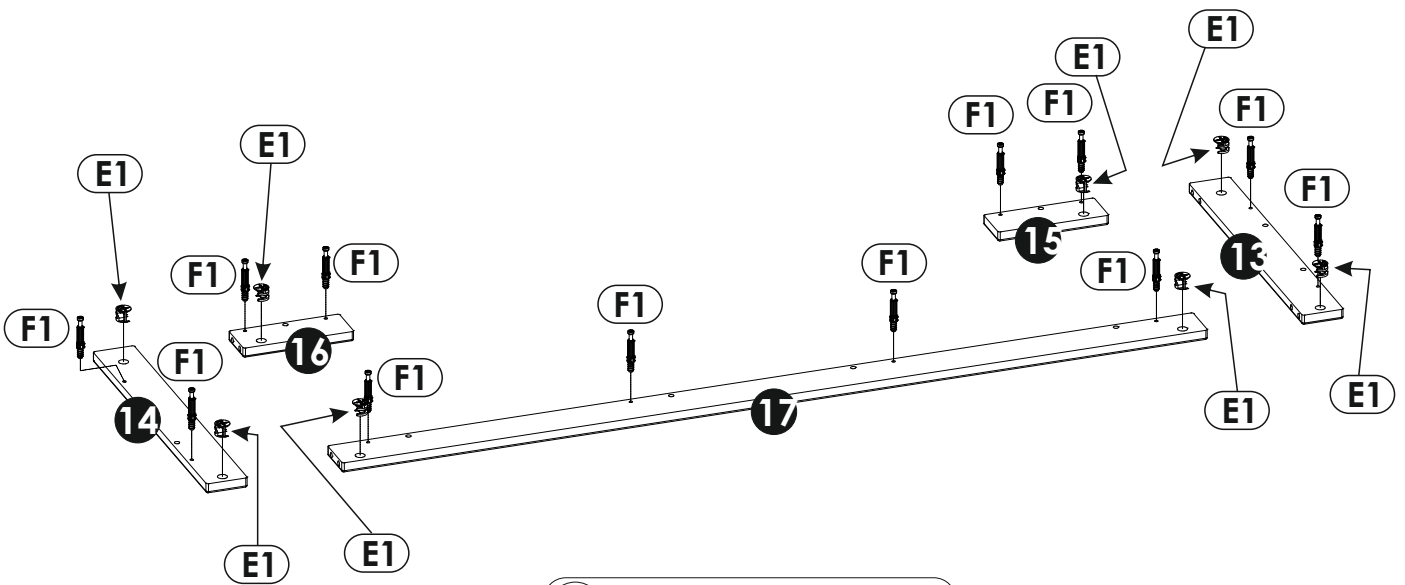

26 ▶

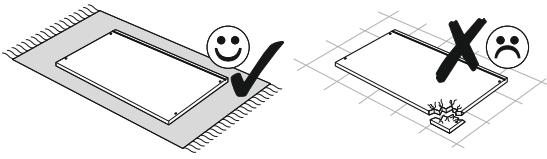

!

A1		8 x 35 mm
A2		8 x 45 mm

A2	x4	F3	x4
8 x 45 mm		7 x 58 mm	

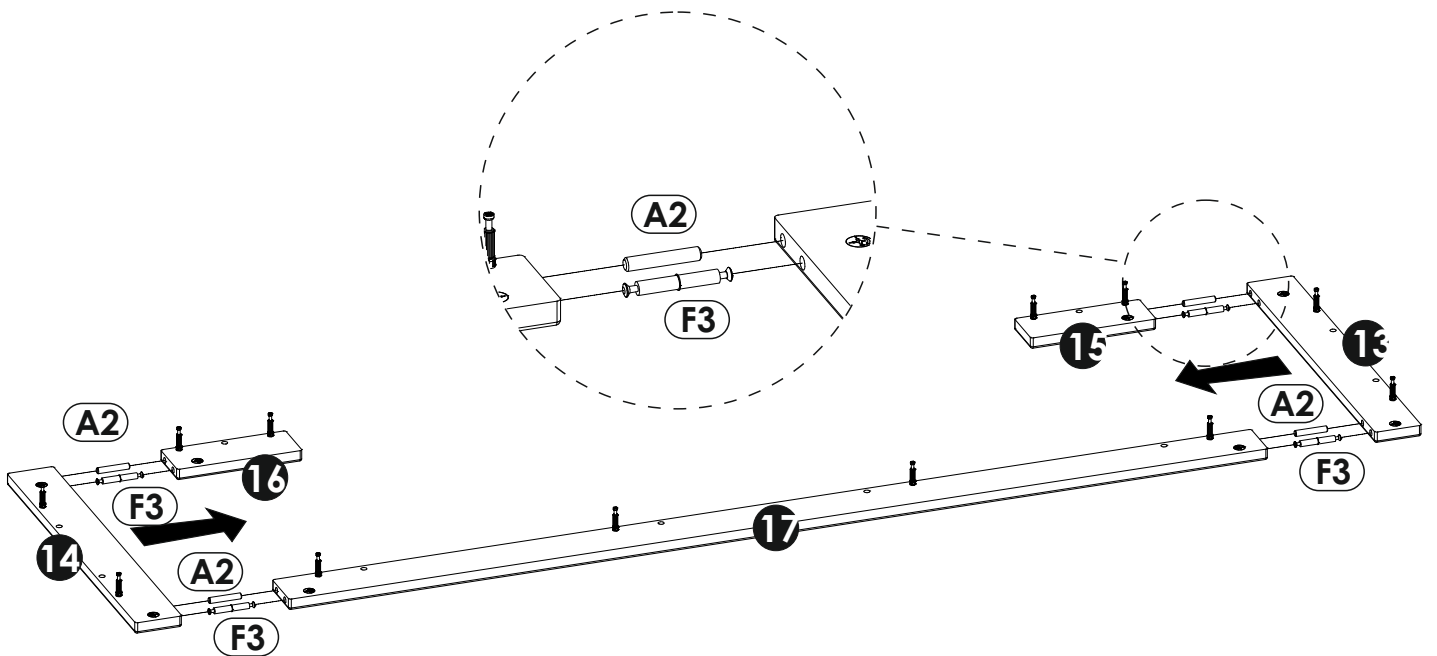
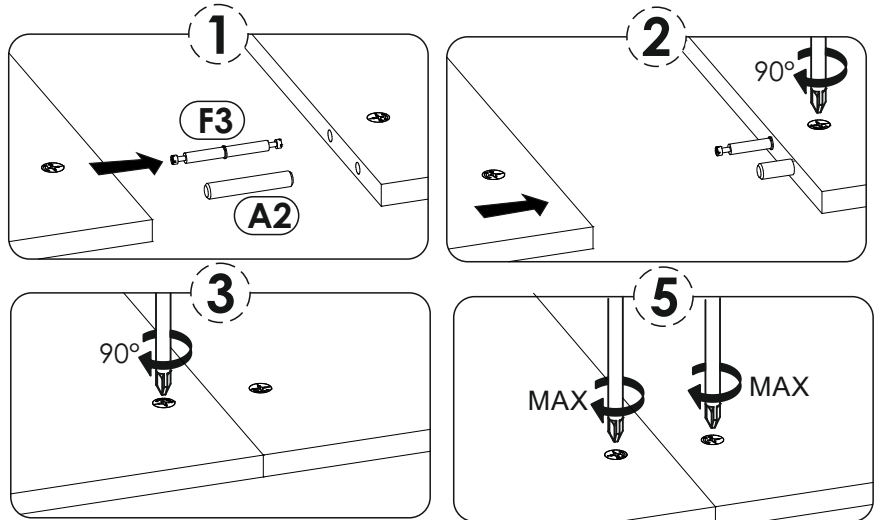

28 ▶

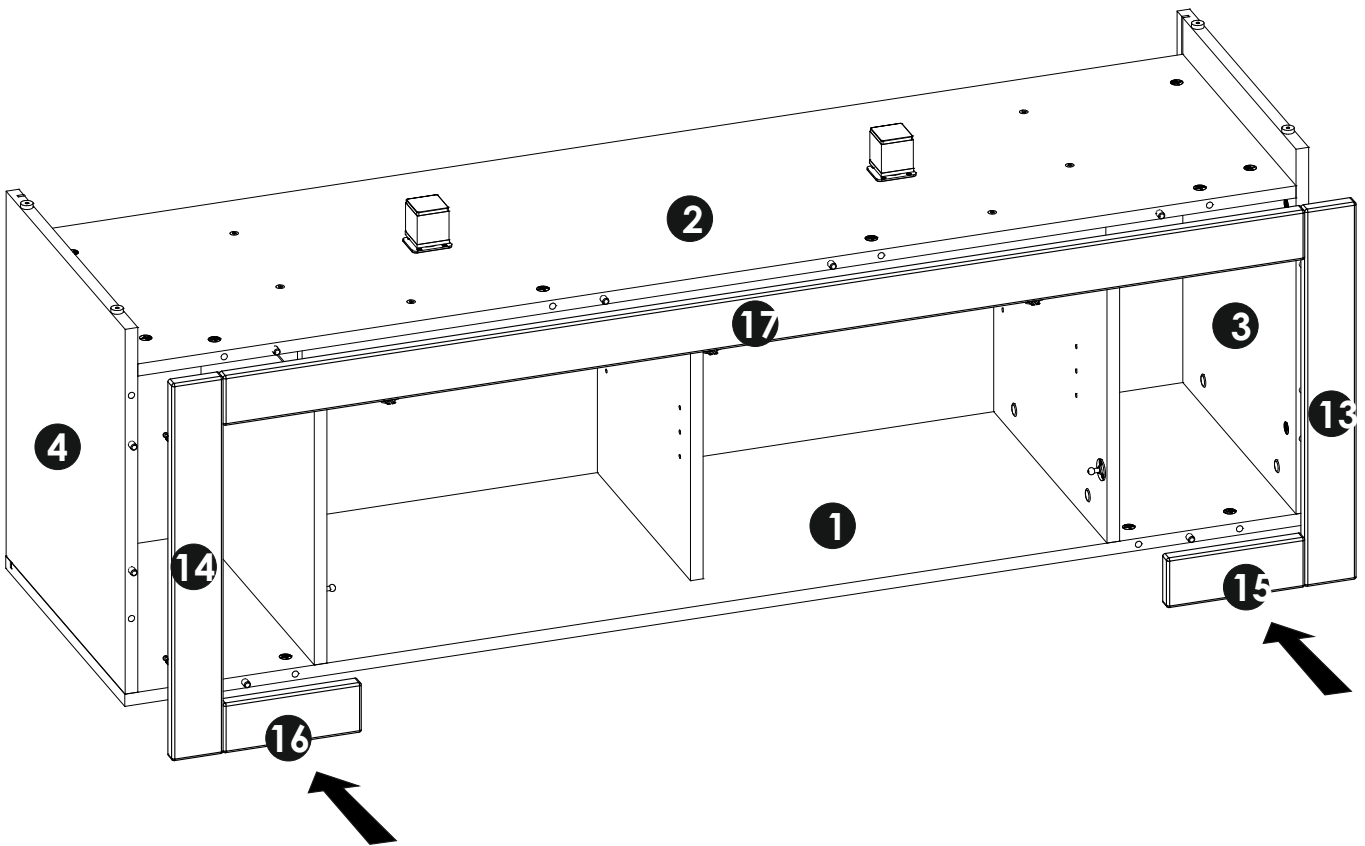
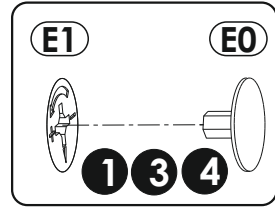
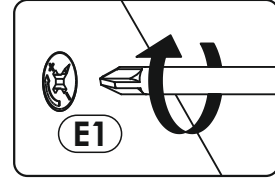
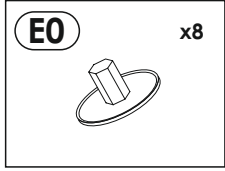
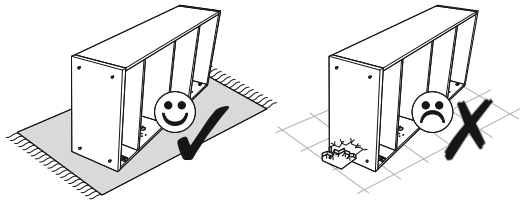

28

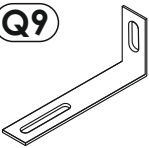
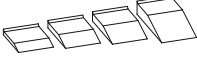
I2	x2
	
4 x 16 mm	
Q9	x2
	
Z	x1
	

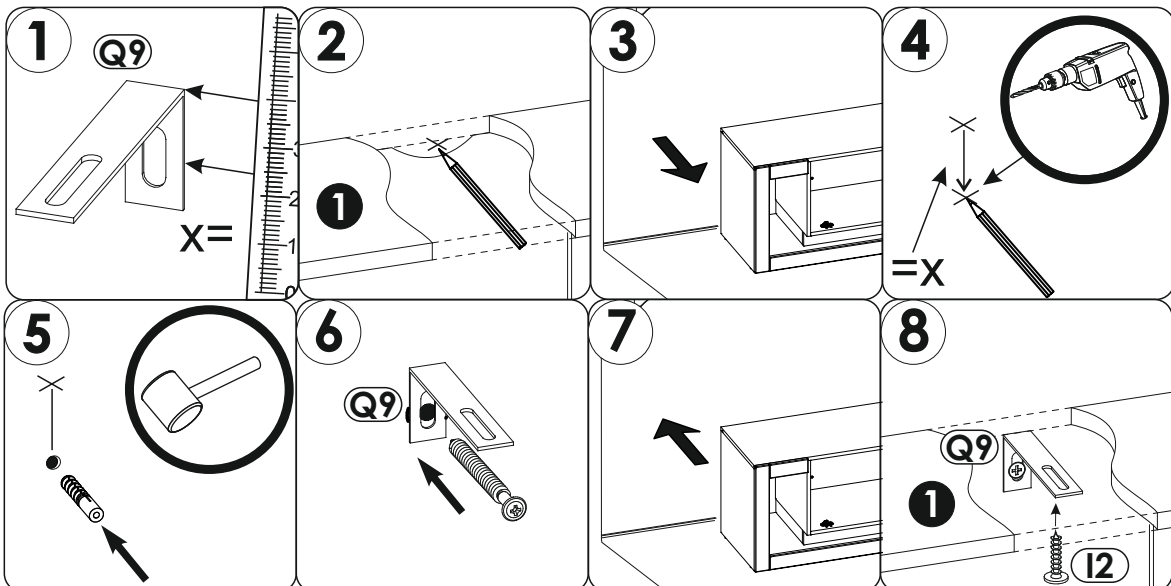
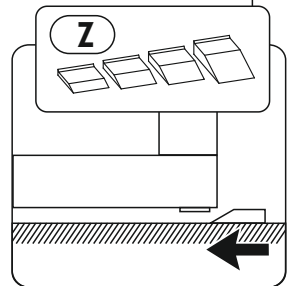
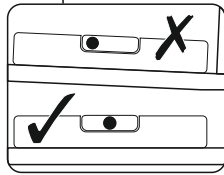
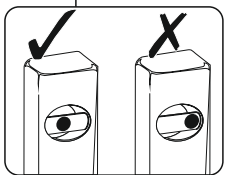
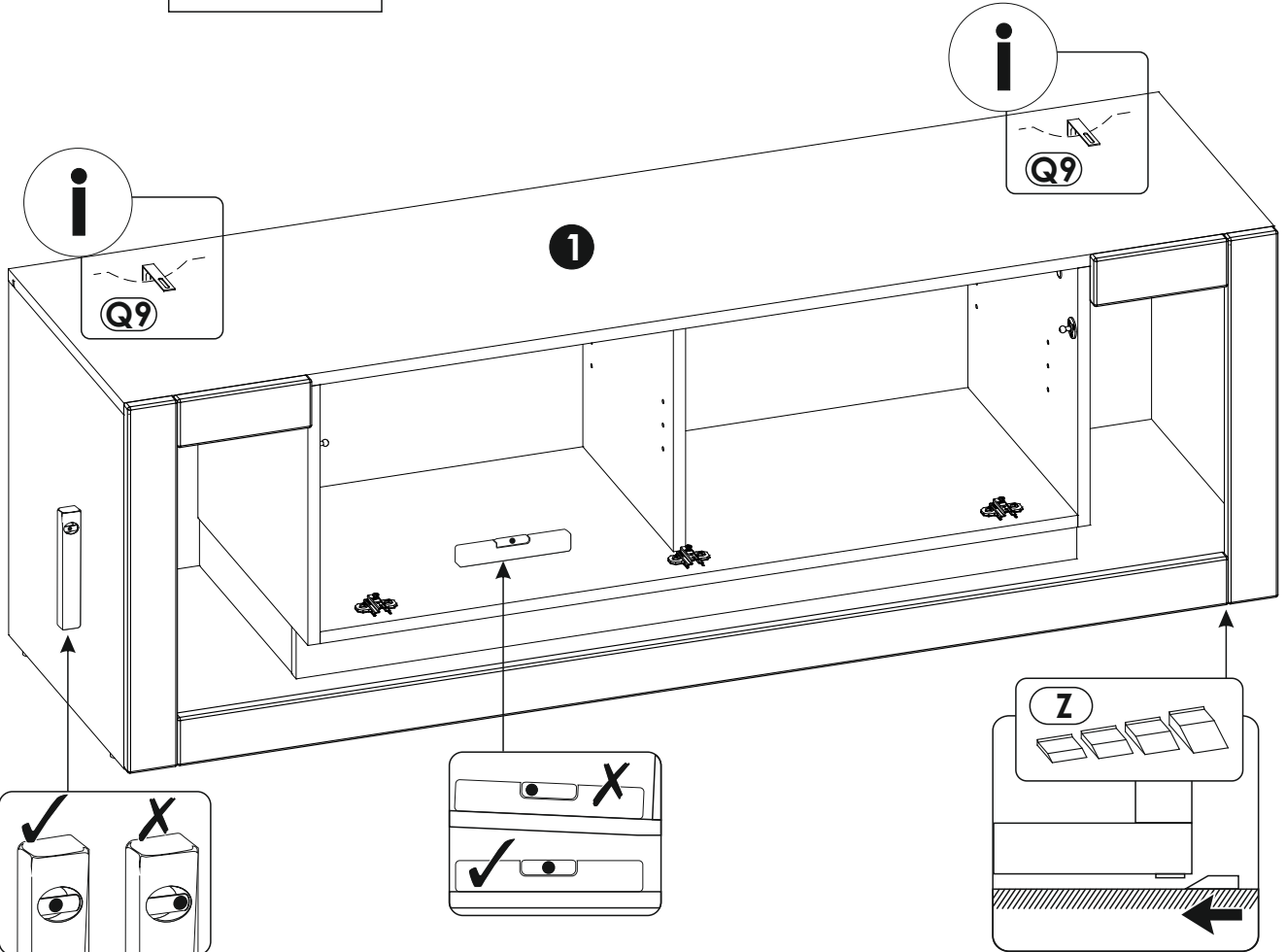
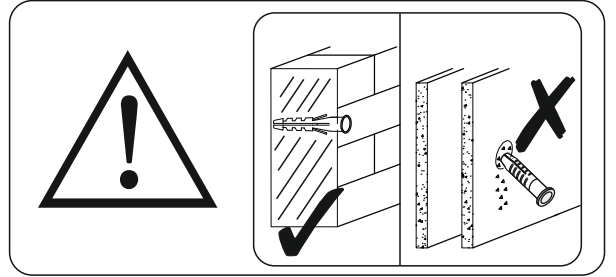

28 ▶

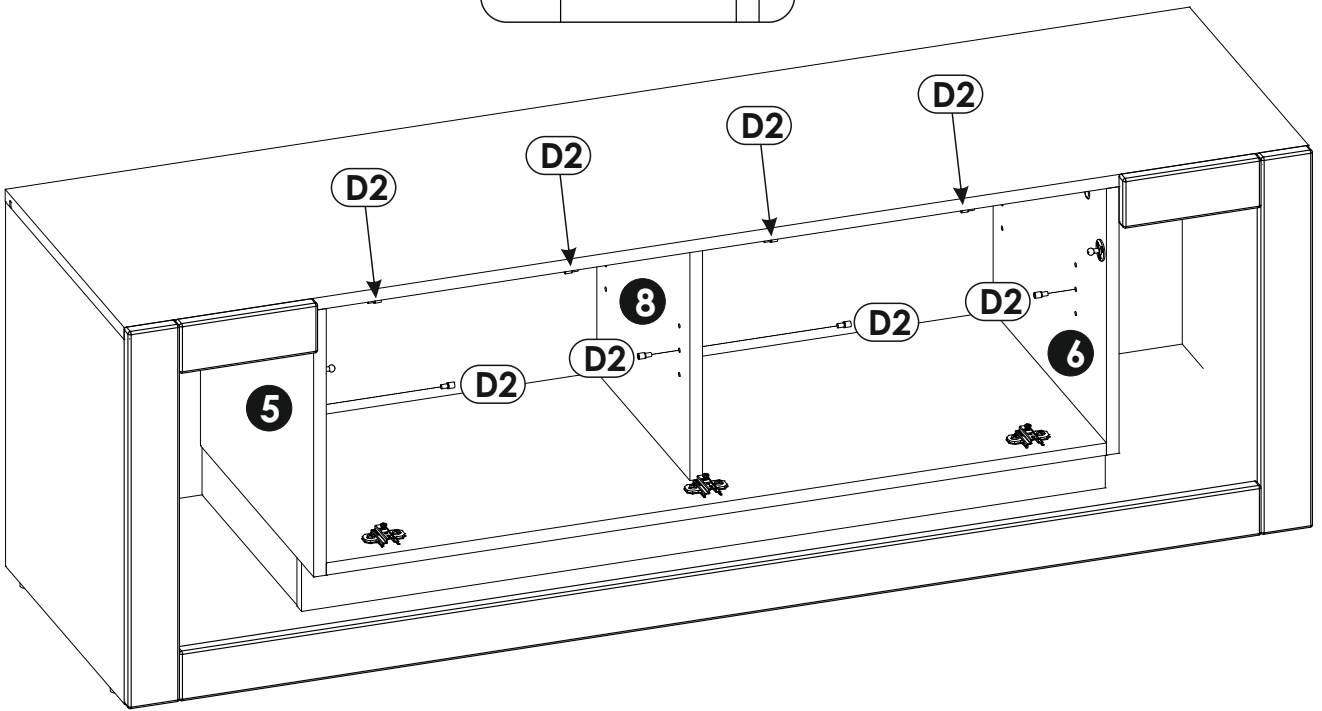
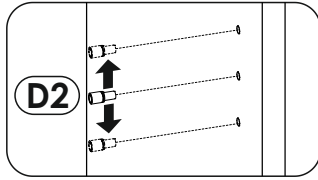
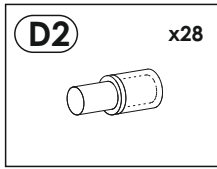

29 ▶

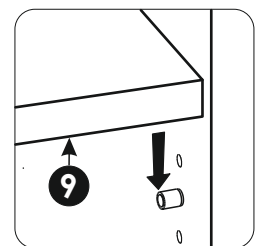
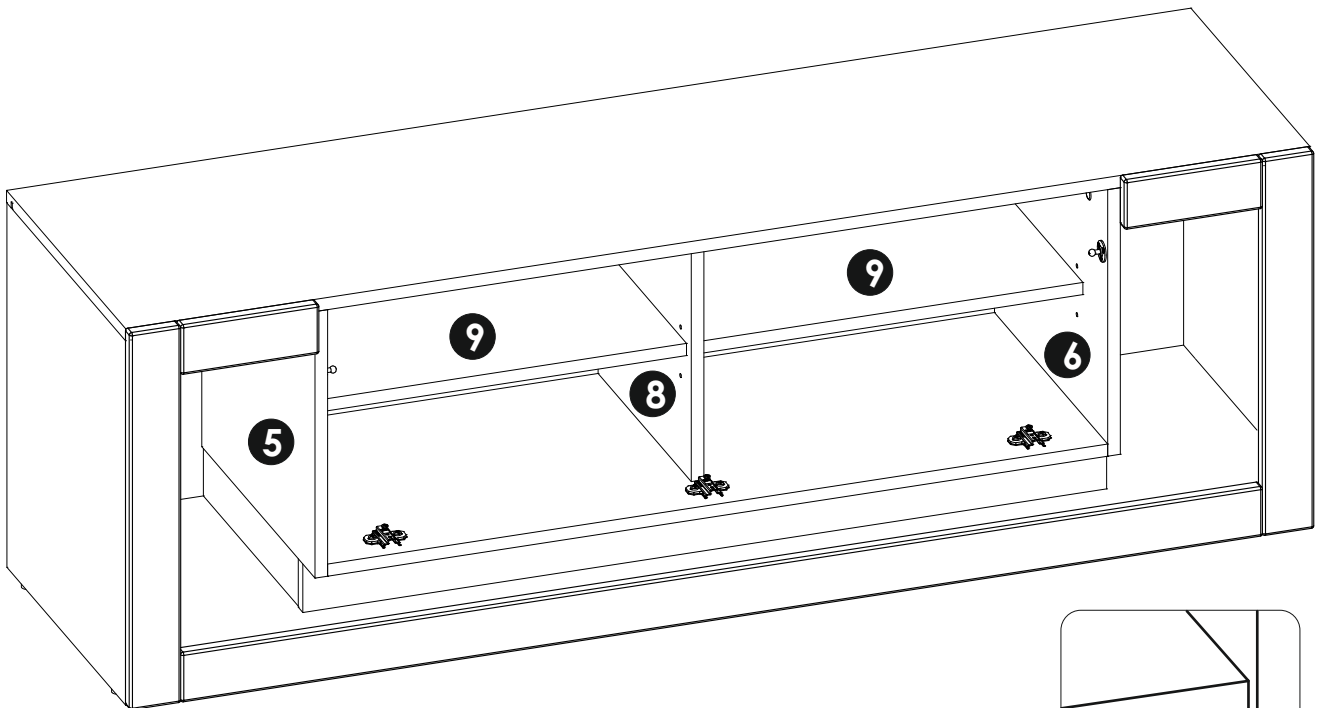

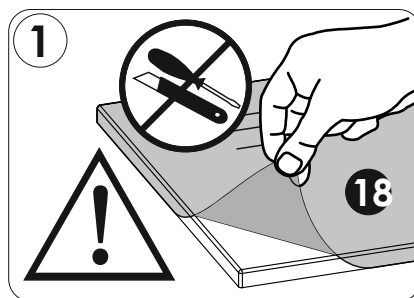
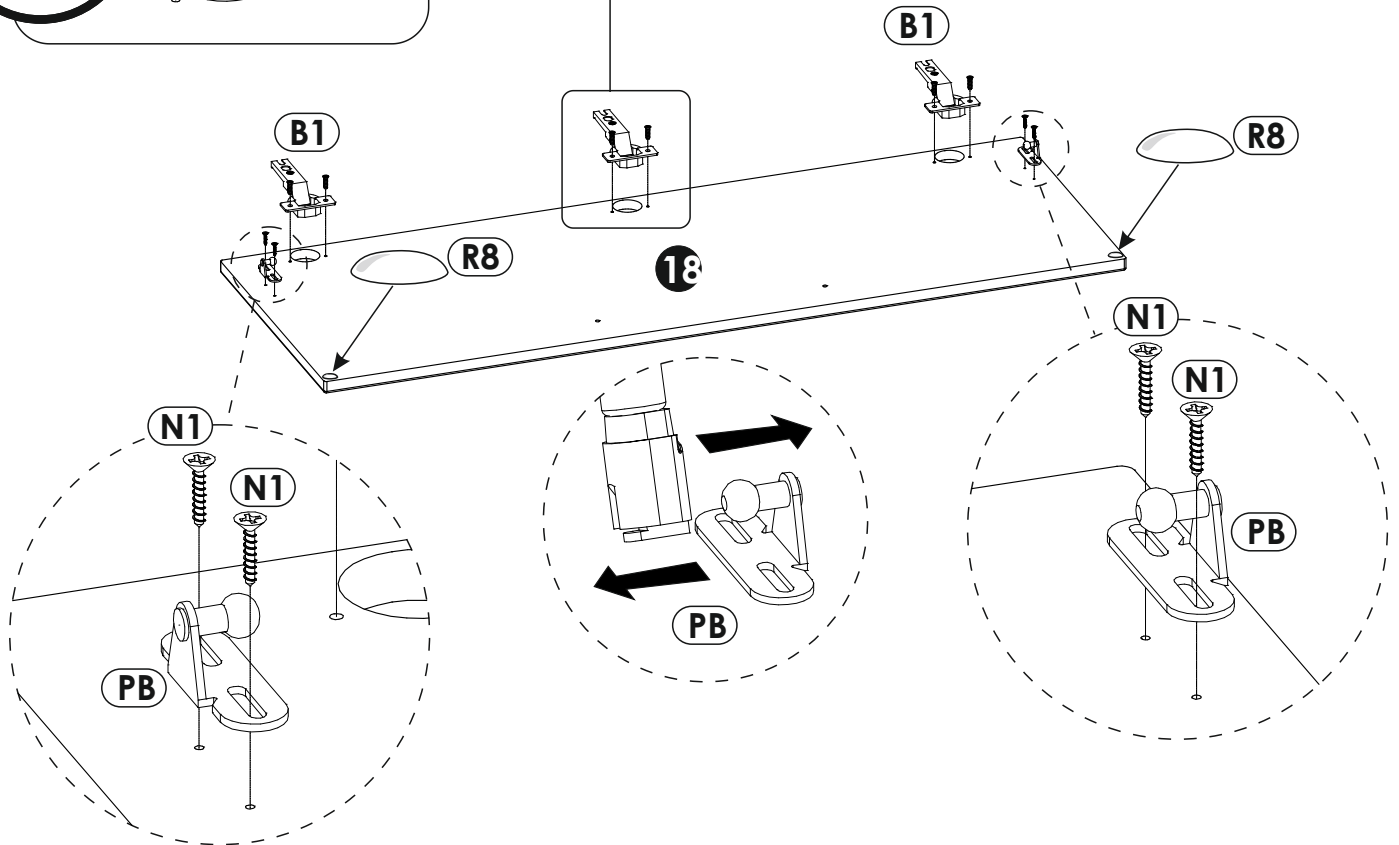
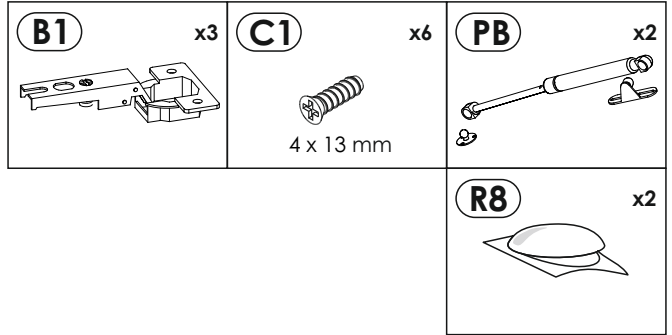
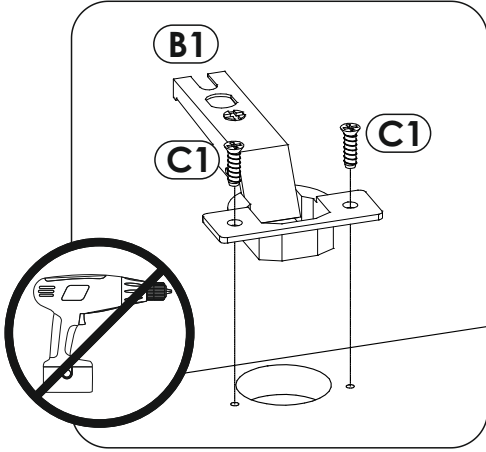
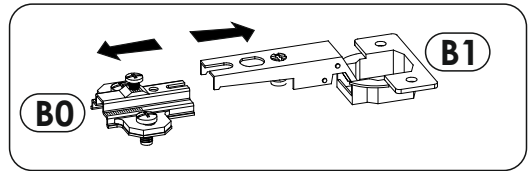
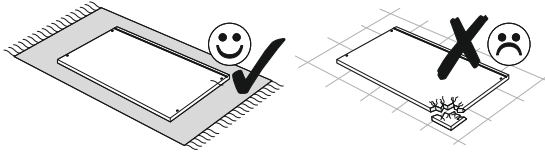

30 ▶

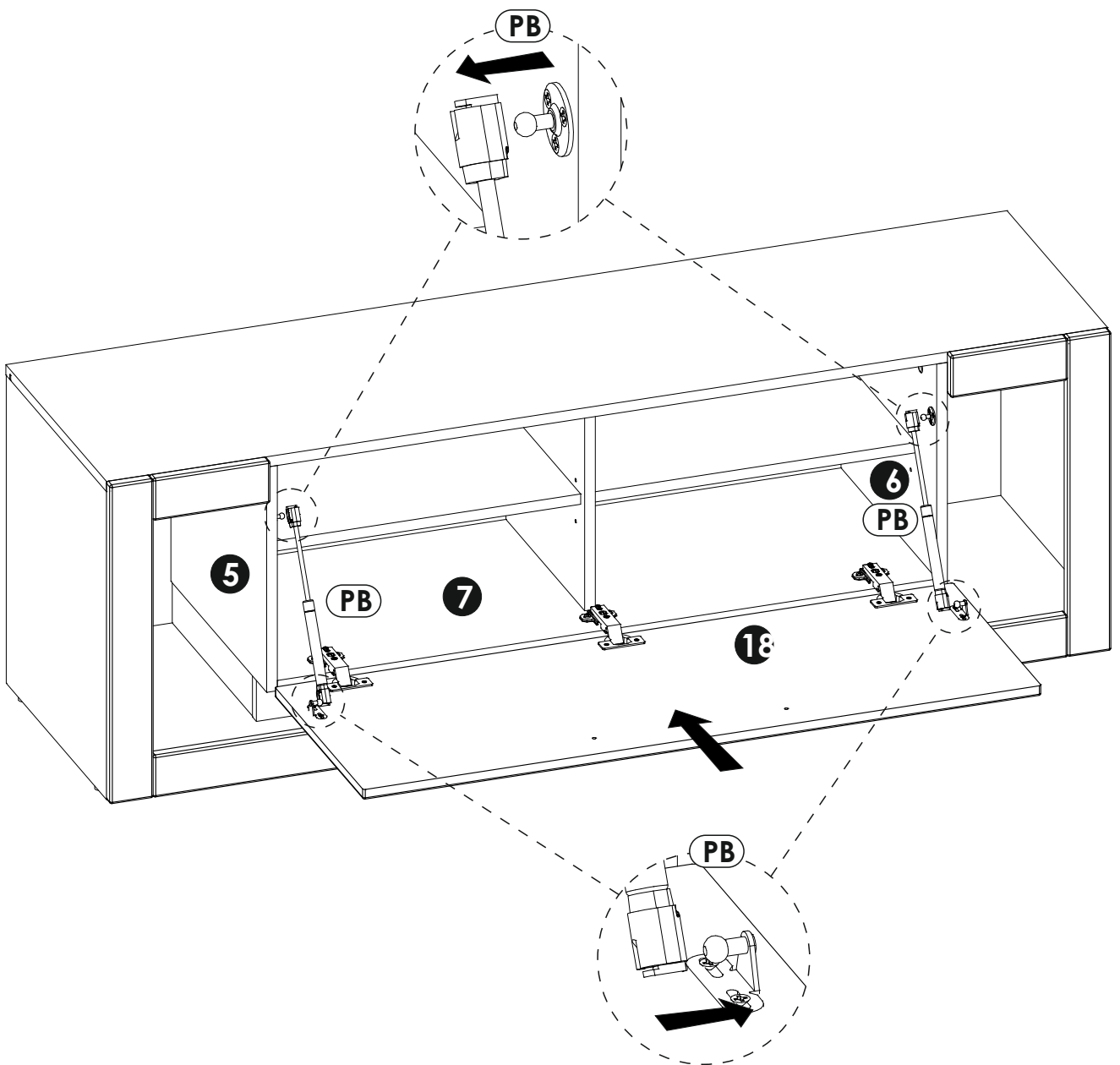
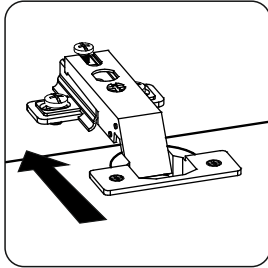

31 ▶



32 ▶

H1	x1	I6	x2
			
L - 148 mm		3,5 x 27 mm	

