

Minto

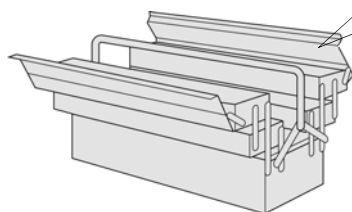

- | | |
|----------------------------------|---------------------------------------|
| D Montageanleitung | GB Assembly instructions |
| FR Notice de montage | NL Handleiding voor de montage |
| CZ Montážní návod | IT Istruzioni di montaggio |
| RO Instrucțiuni de montaj | RU инструкция по сборке |
| PL Instrukcja montażu | SK Návod na montáž |
| HU Szerelési útmutató | TR Montaj talimatı |

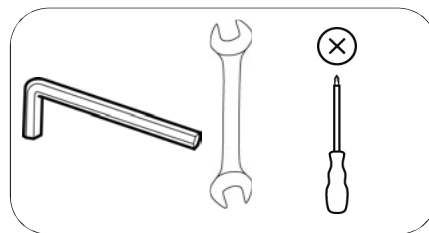
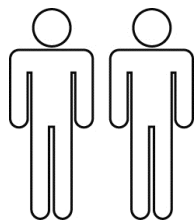

Bei der Montage Kopfteilbrett unbedingt beachten !

**Bettkasten
Außenseite**

**Teil 4
Bettseite-
Innen**

Kopfteilbrett vor der Montage

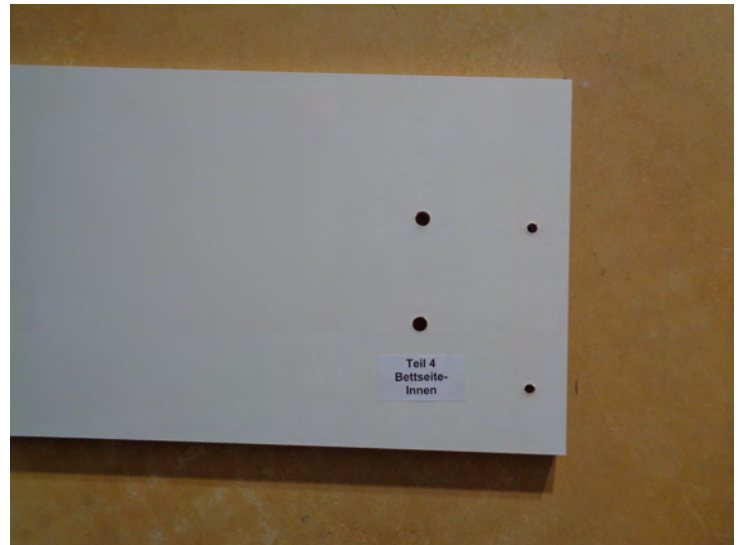

Kopfteilbrett nach der Montage



0
10
20
30
40
50
60
70
80
90
100
110
120
130
140
150
160
170
180
190
200

Service • Assistenza • Dienstverlening • Serwis Servis • Szerviz • Сервисная служба	
Name • Nom • Nome • Naam Nazwa • Jméno • Názov • Név Denumire • İsim • Название	Minto EB
Nr. • No. • N° • Номер • Č • Sz	SH44-54
Typ • Type • Tip • Típus • Tipo Тип	BK zerl. OHNE

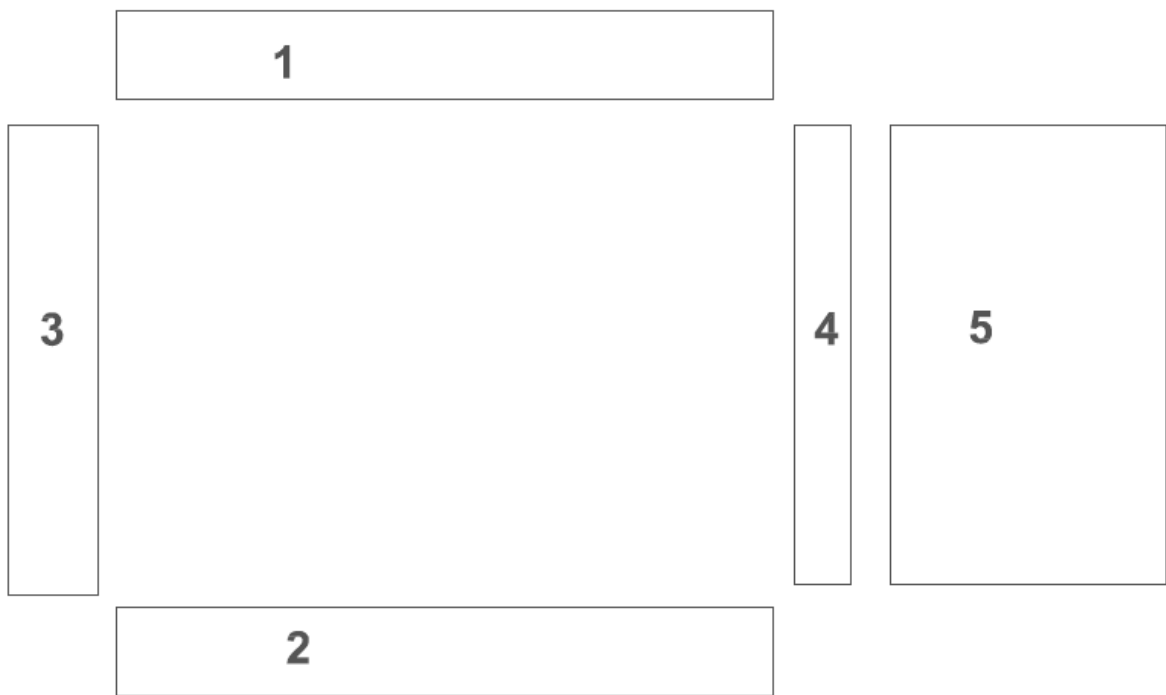

A	B	C	D	E
16x 6x30	4x	16x 3,5x20	4x	4x

G	H	I
4x	4xM8	4x M8



J
4x 8x70

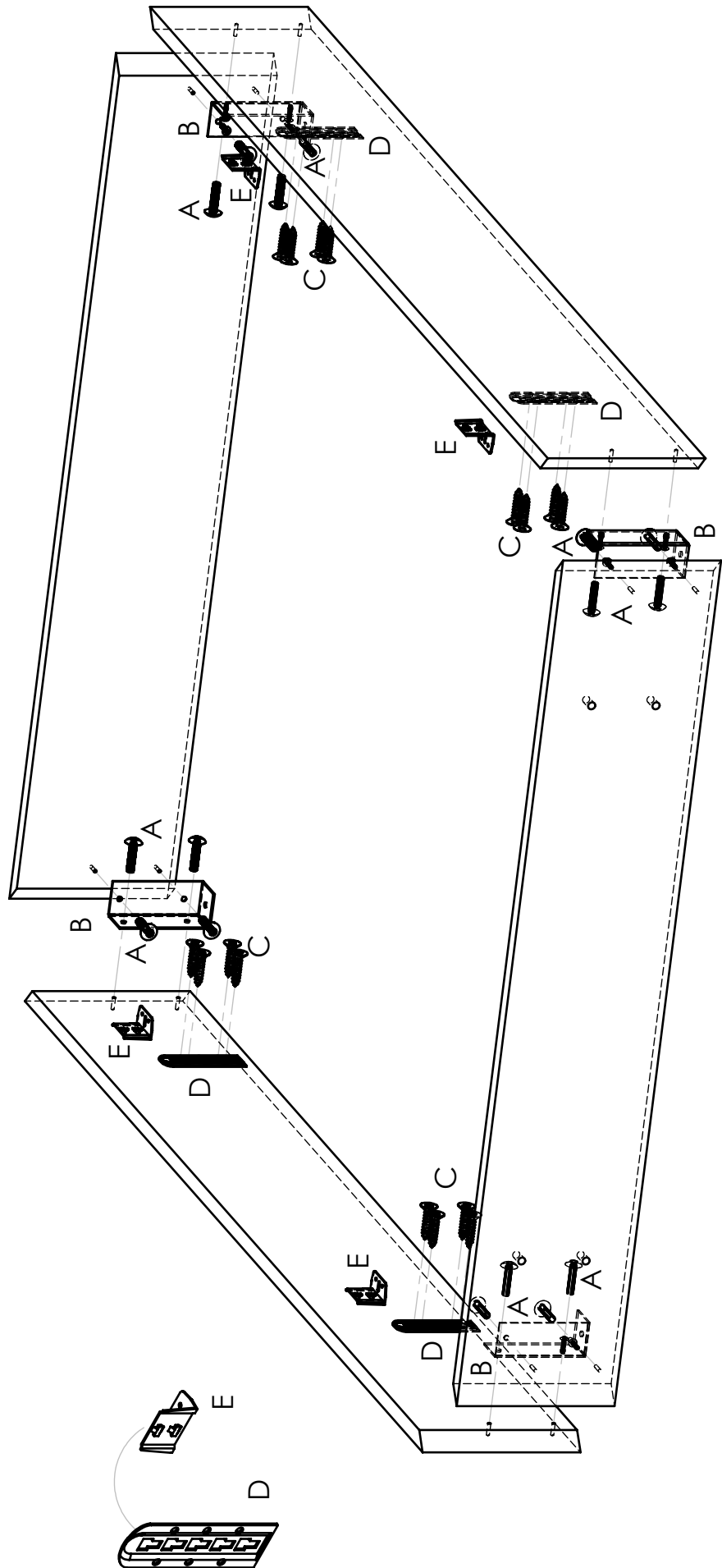

A	B	C	D	E
16x 6x30	4X	16x 3,5x20	4X	4X

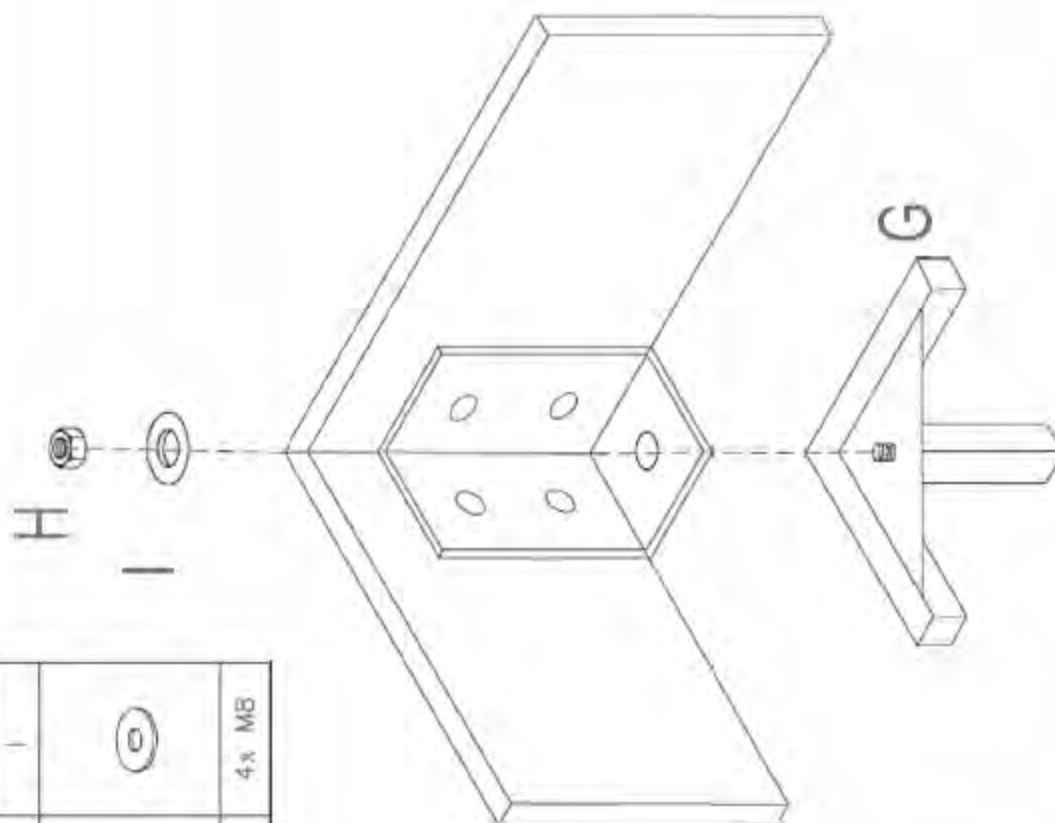



I		4x MB
H		4xMB
G		4x

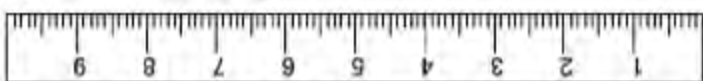



Kopfteil zum Schluß montieren

