

980336

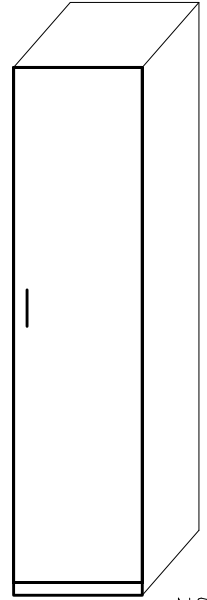

NSP 43 ZB

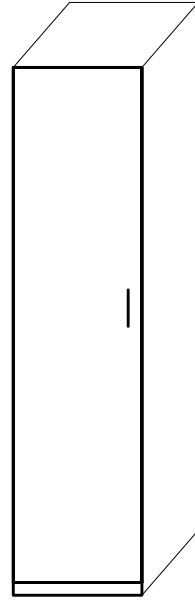

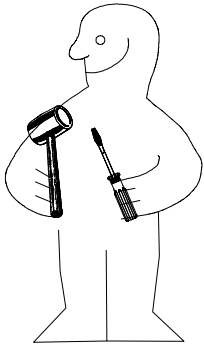
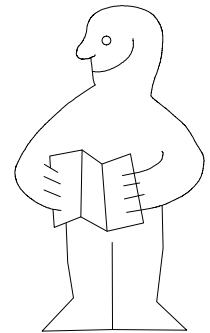
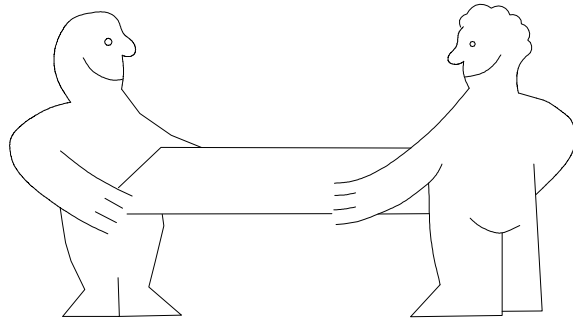
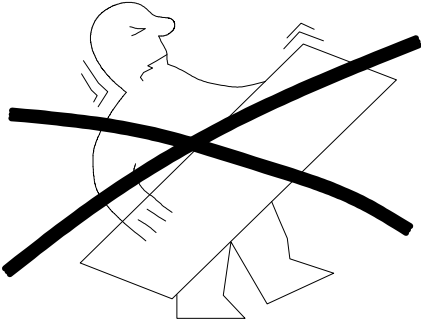

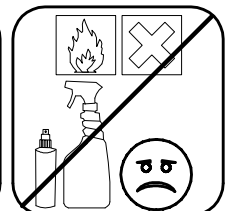
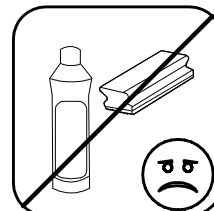
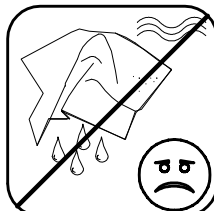
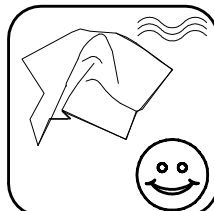
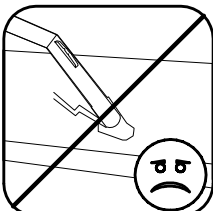
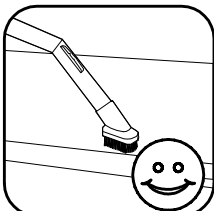
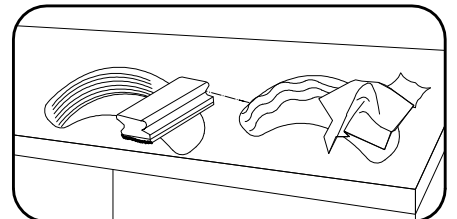
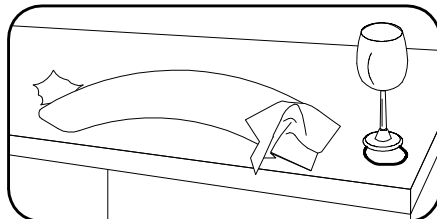
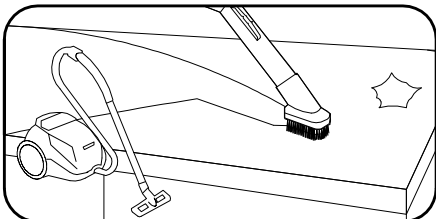
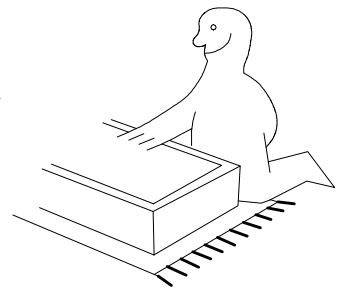
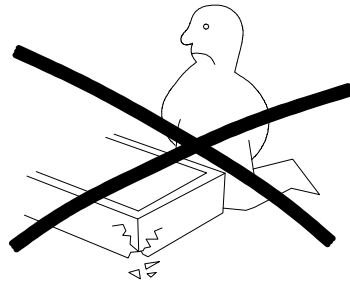
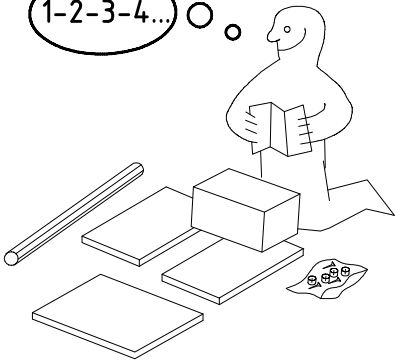
1-2-3-4... ○







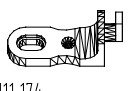
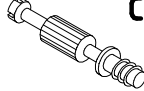

980336

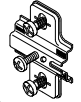
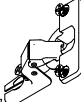
06.04.16 / -

04 16 | 1/8

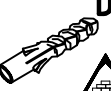
 111 102	A	8x
 111 610	L7	12x
 111 174	J1	2x
 111 103	C	8x

 112 268	M	3x
 112 267	N	3x
 M6 x 11 mm	T6	2x
 3,5 x 15 mm	G1	2x

 111 618	D20	1x
 6 X 60 mm	G16	1x
 4 X 15mm	SP15	1x
 111 052	o10	1x

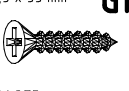
 3,5 x 35 mm	G14	4x
121 375		

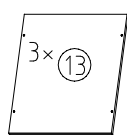
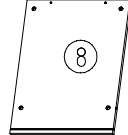
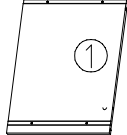
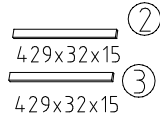
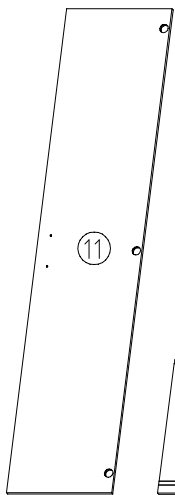
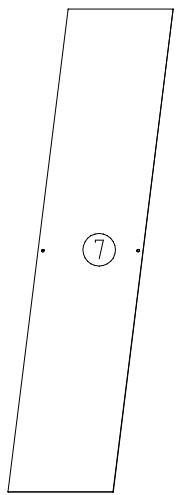
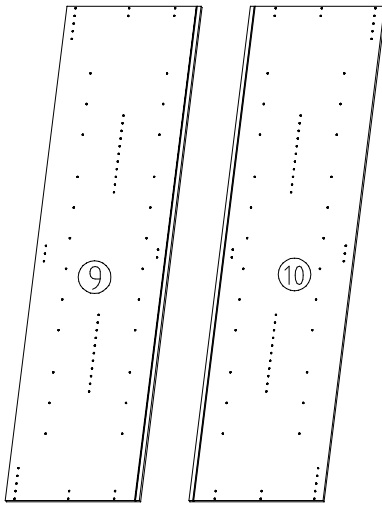
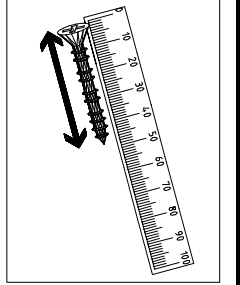
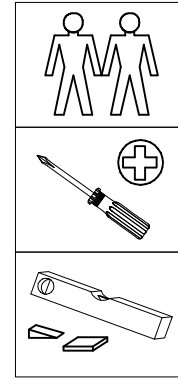
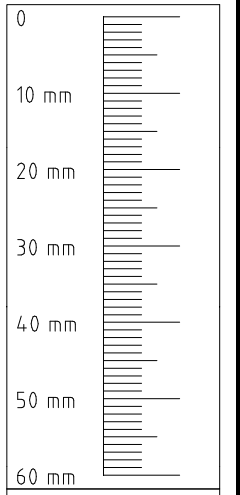

2064x560x15

2064x560x15

2015x438x2,5

2021x439x15

429x560x15

429x560x15

429x500x18

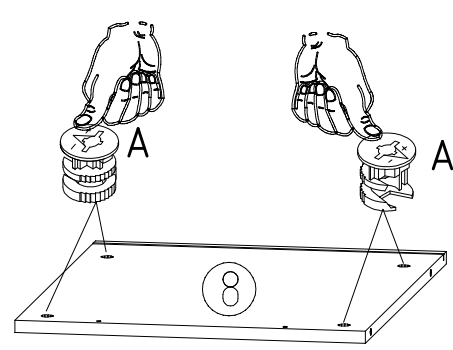
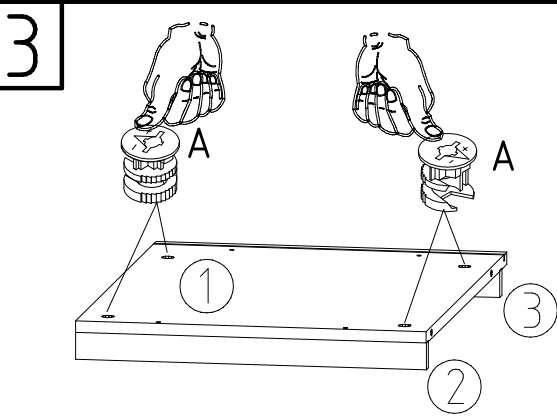
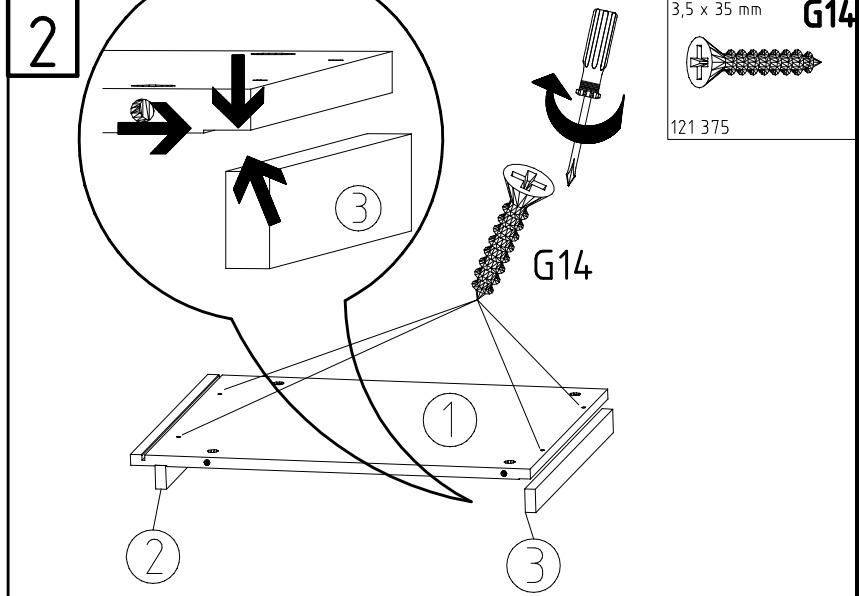
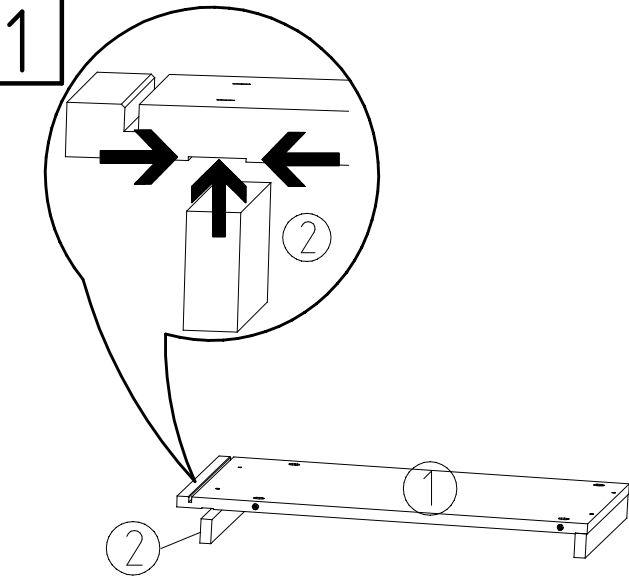

4

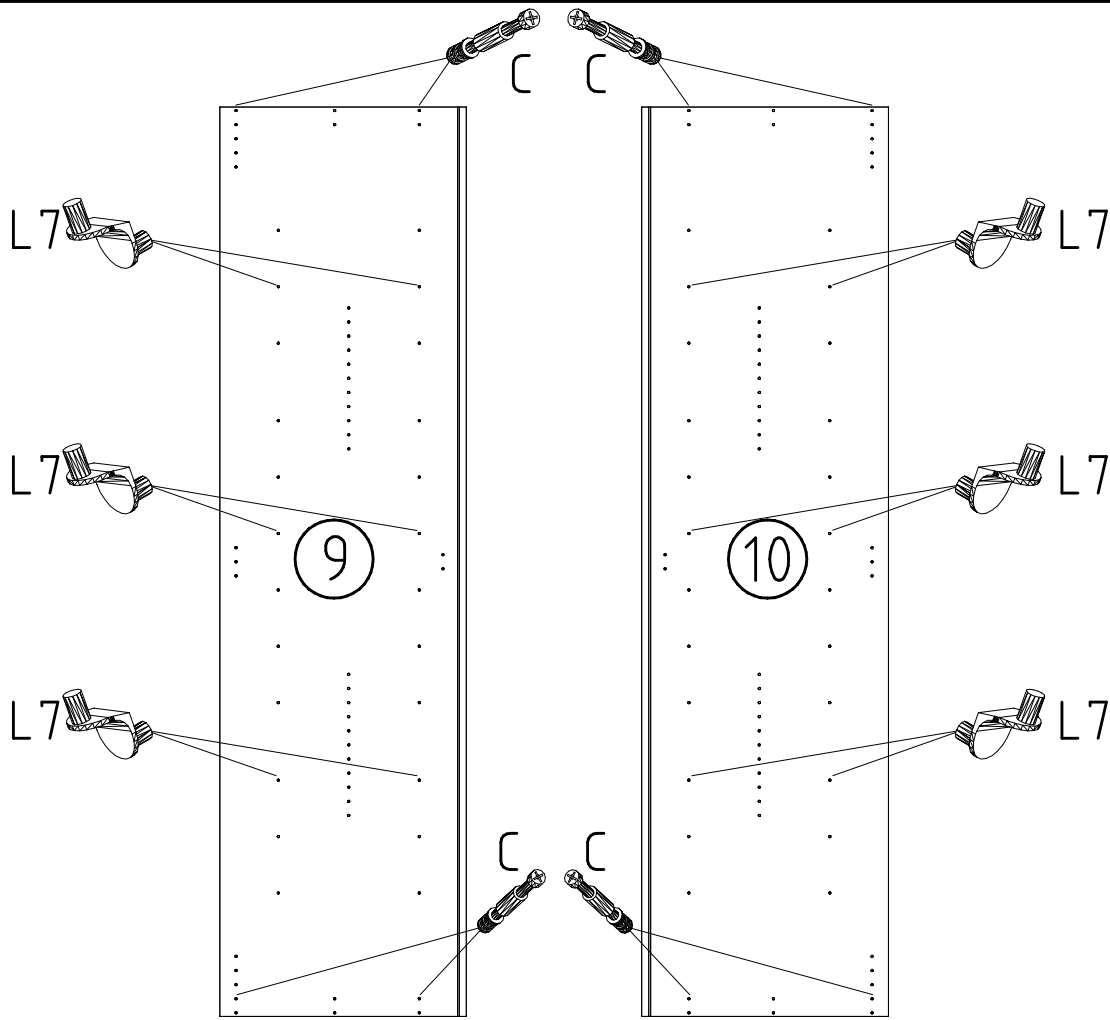

5

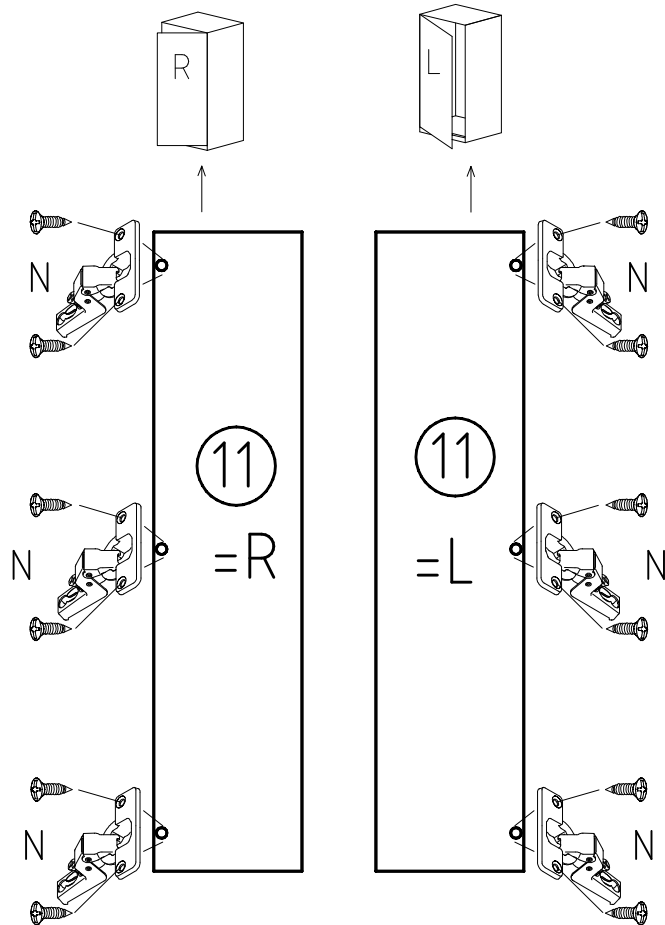

6

9

1

7

7

9

1

3,5 x 15 mm G1

121 370

J1

111 174

M6 x 11 mm T6

121 181

T6

G1

J1

8

8

9

9

8

10

9

1

10

M

M

M

M

M

M

M

112 268

11

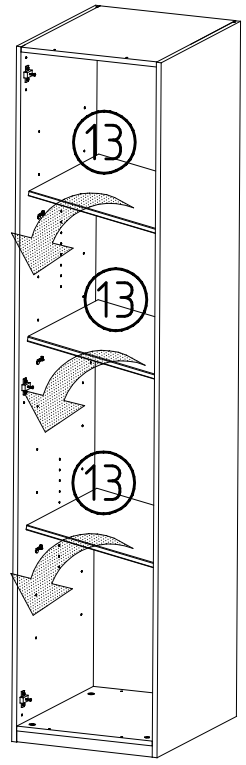

12

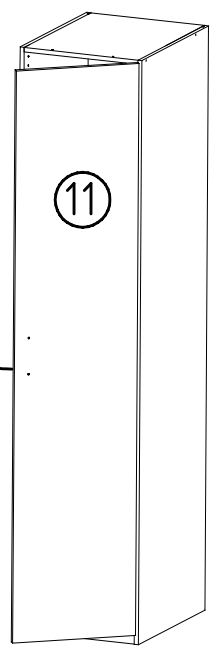
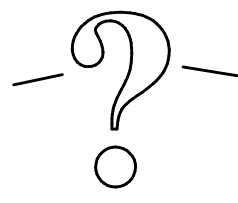
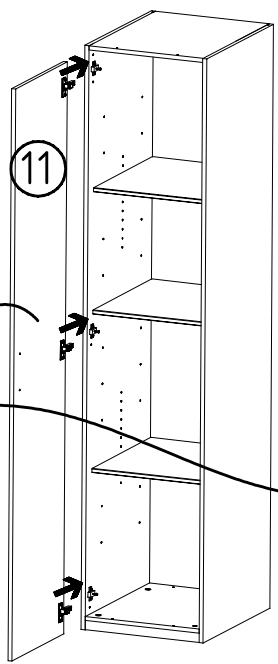
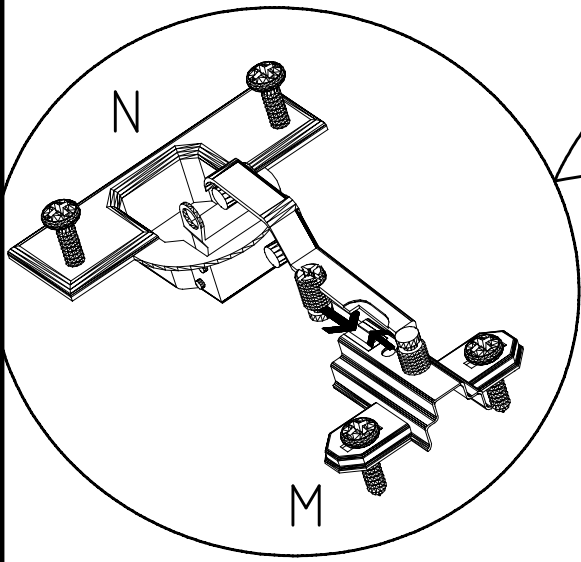
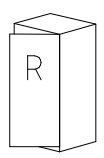
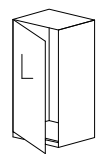
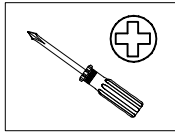

13

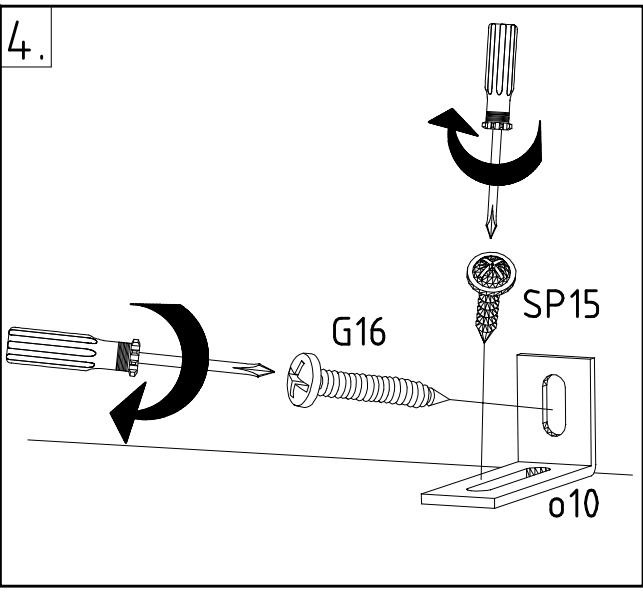
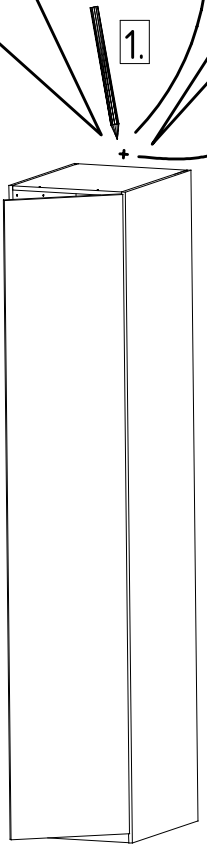
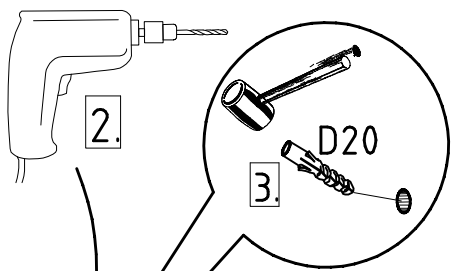
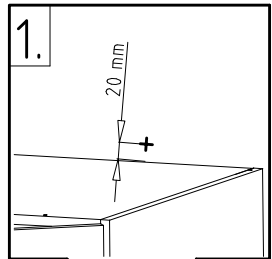
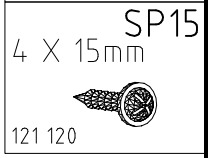
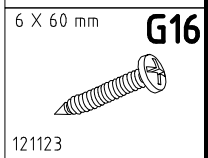
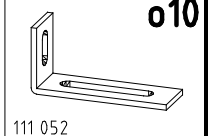
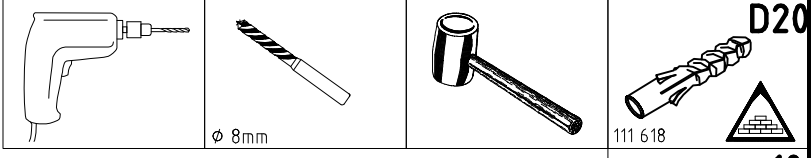
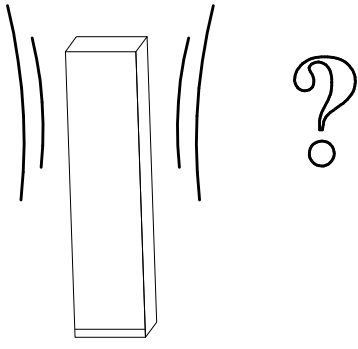

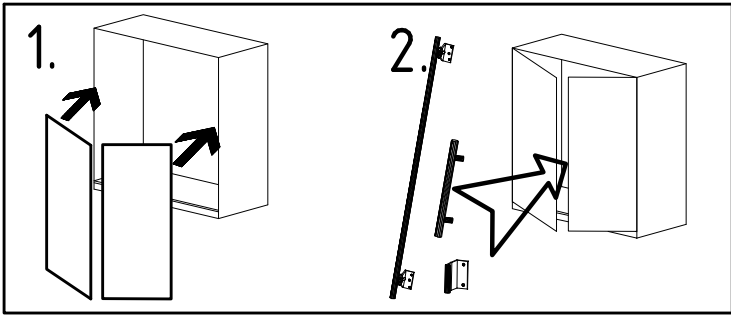
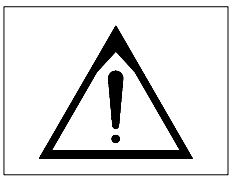

3,5 x 15 mm 121 370	G1	4,0 x 12 mm 122 625	G56
------------------------	----	------------------------	-----

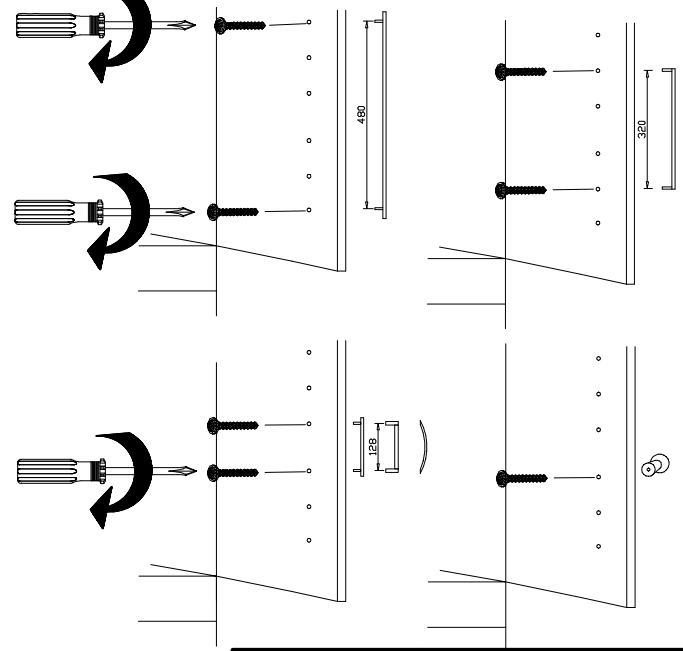
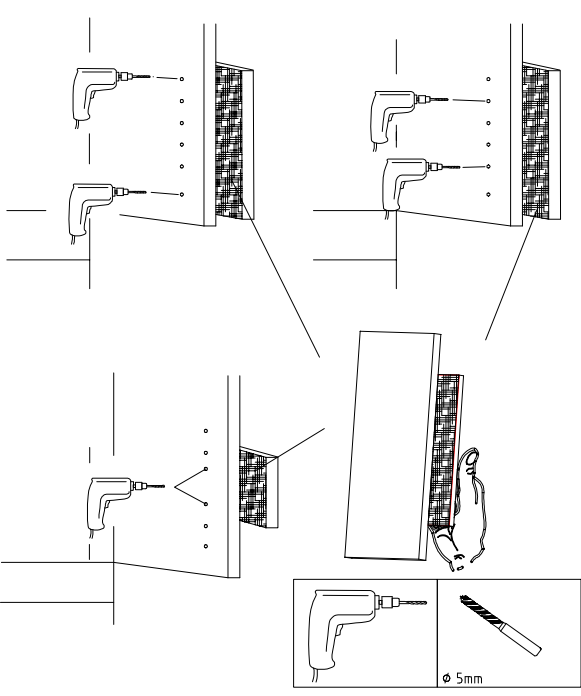
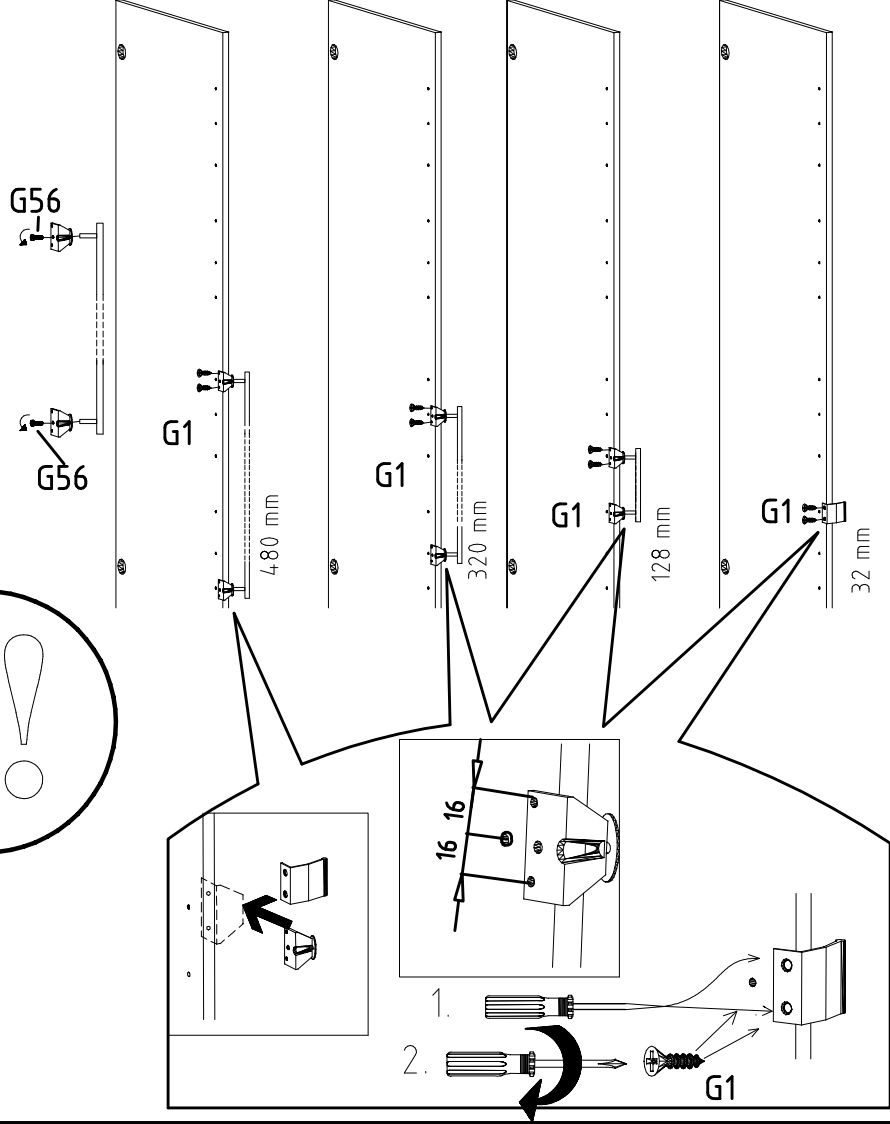
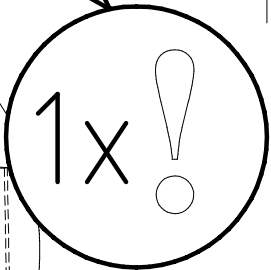
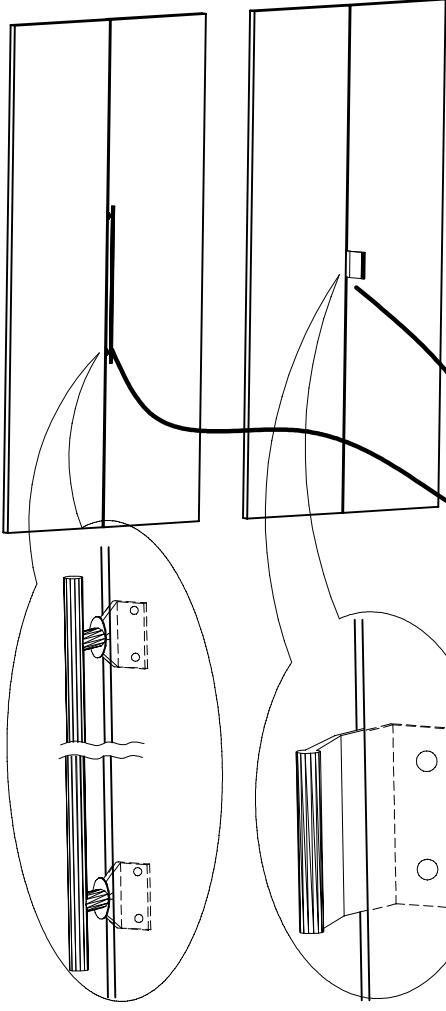

SP27
4 X 27mm
122620
4,0x22
G49
122 609

