

.....
 Hergestellt für:

 serie: xxx

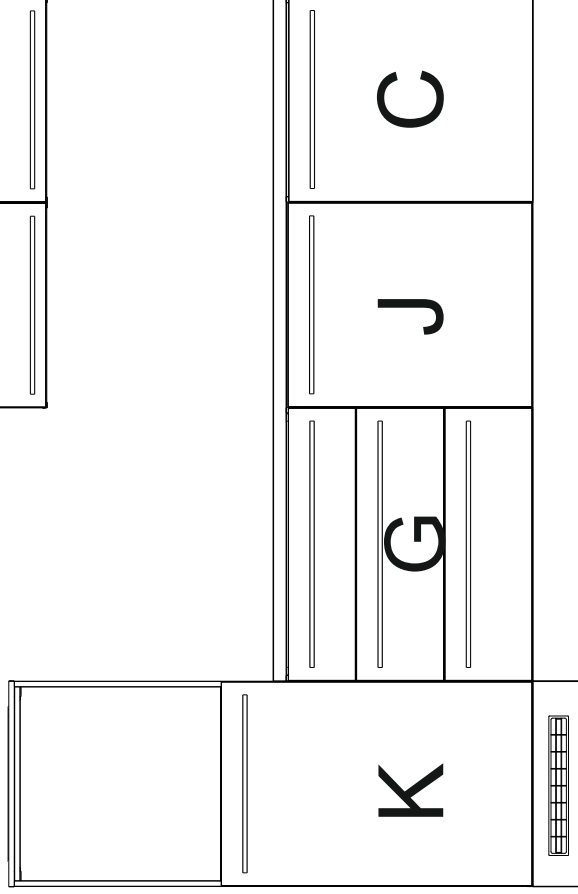

300 min

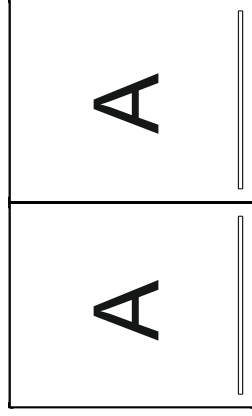
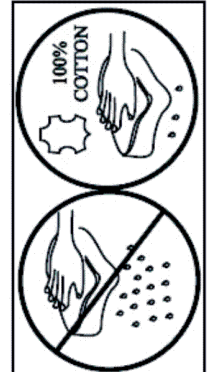
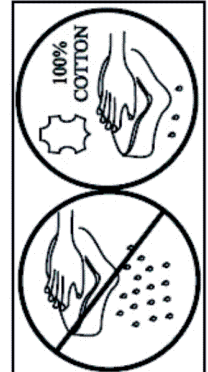
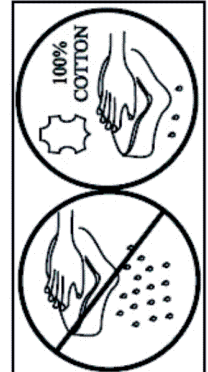
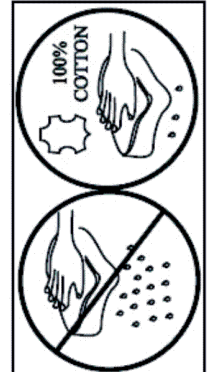
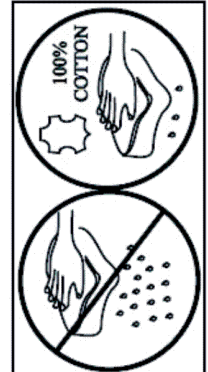
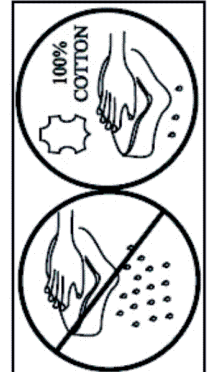
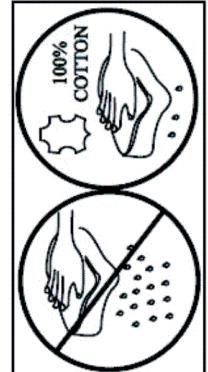
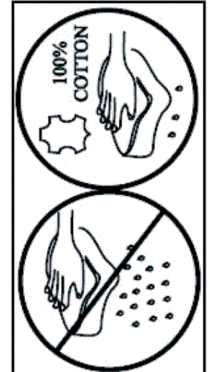
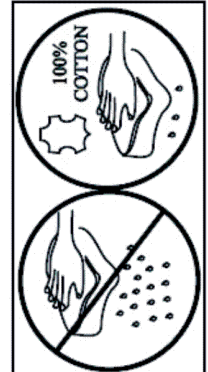
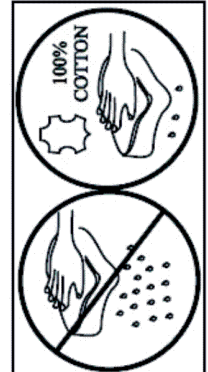
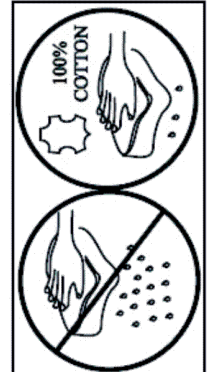
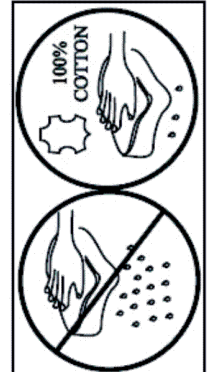
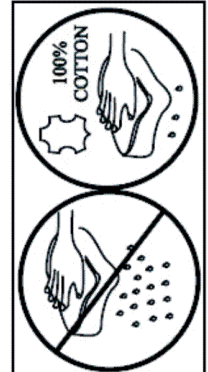
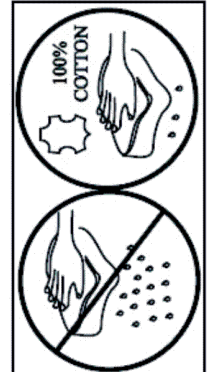
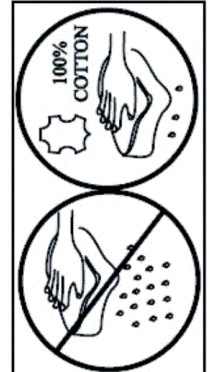
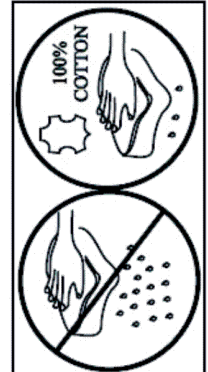
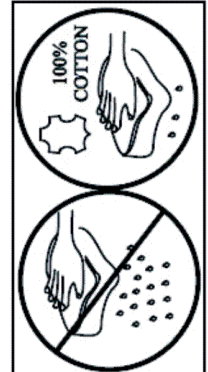
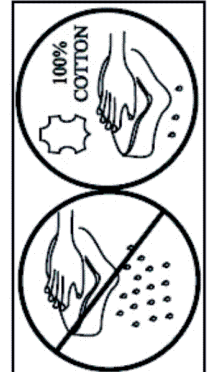
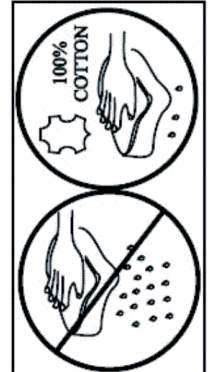
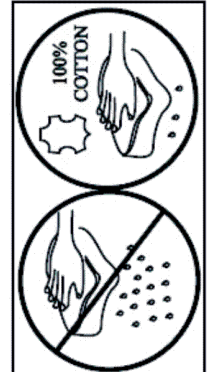
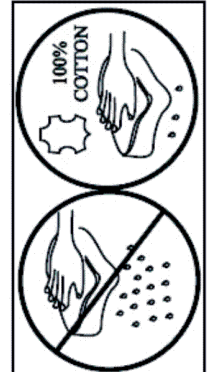
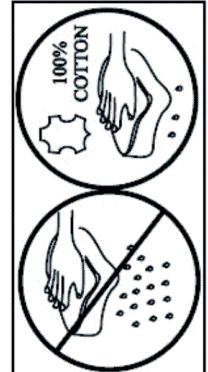
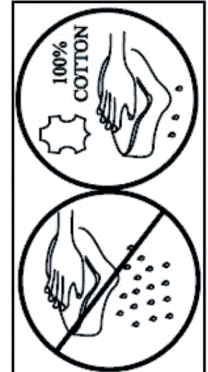
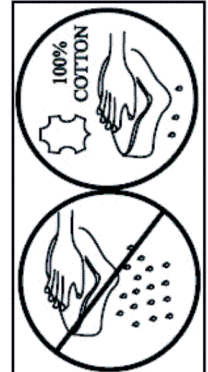
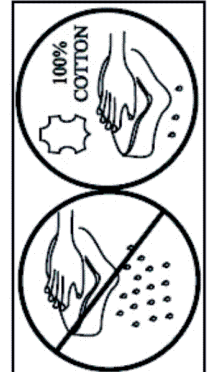
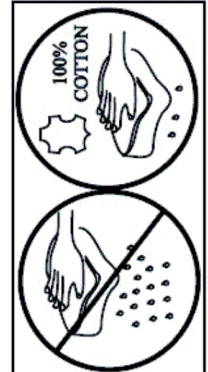
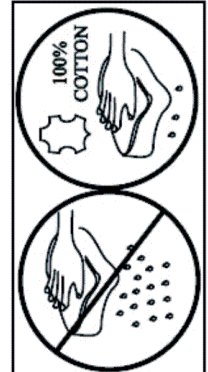
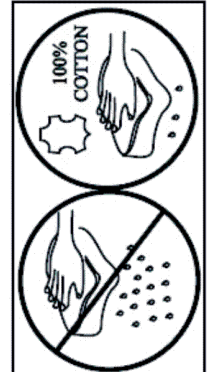
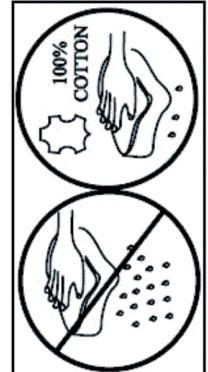
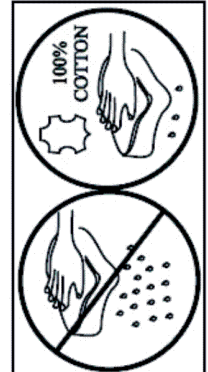
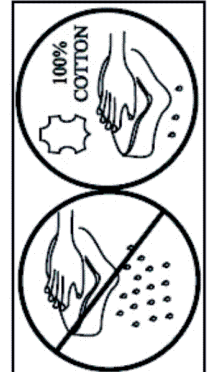
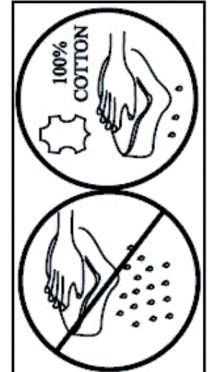
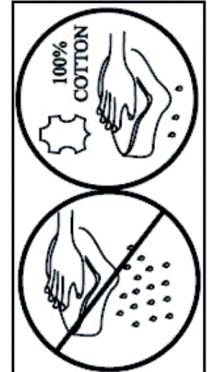
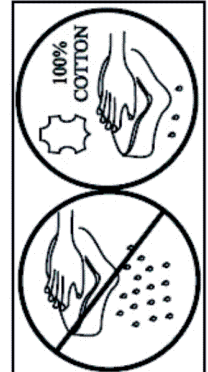
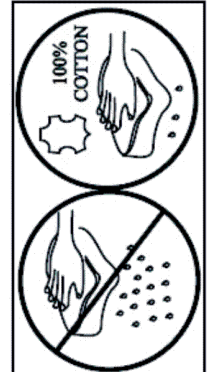
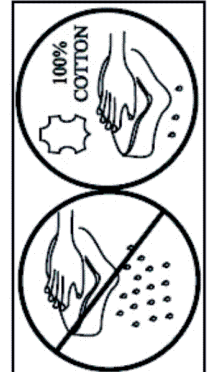
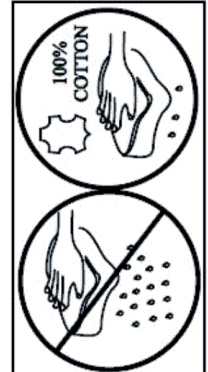
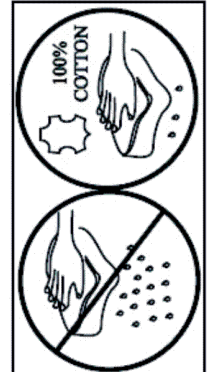
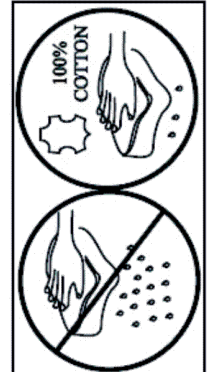
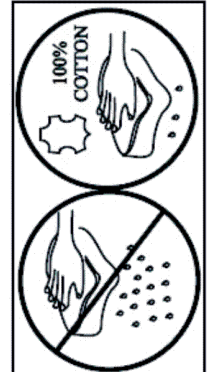
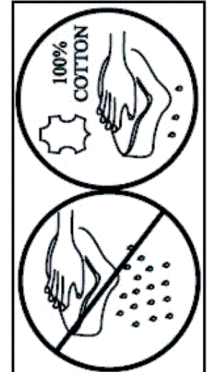
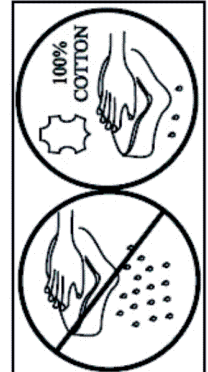
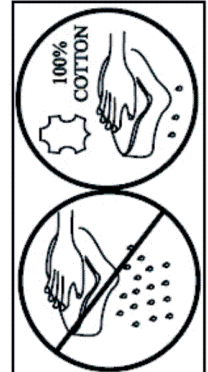
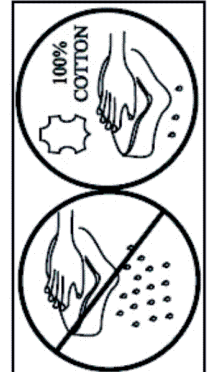
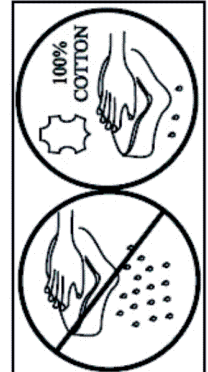
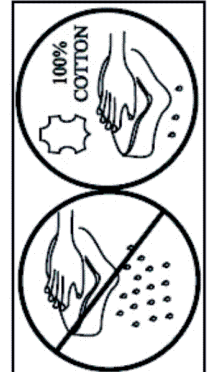
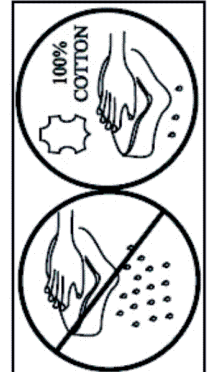
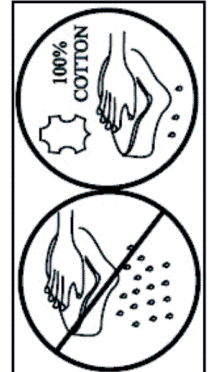
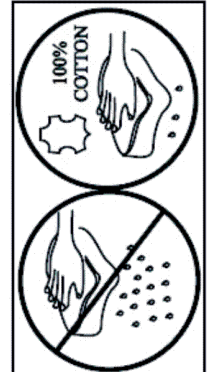
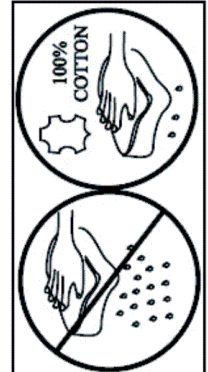
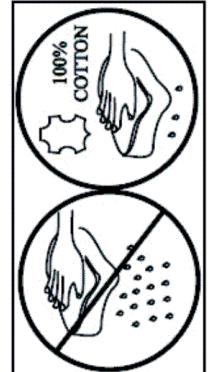
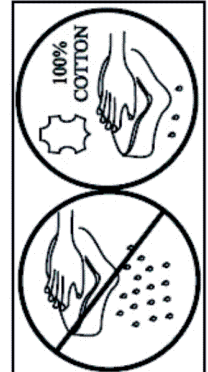
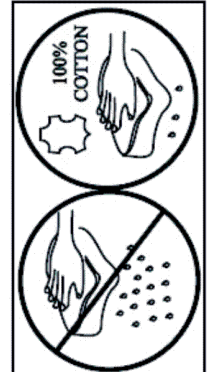
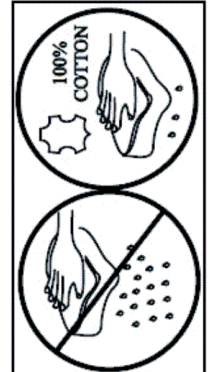
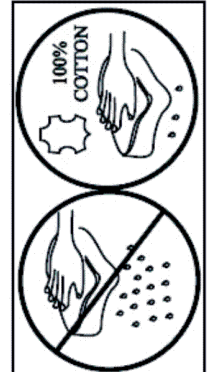
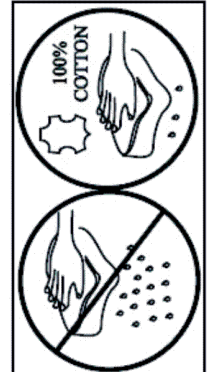
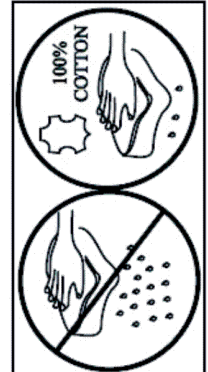
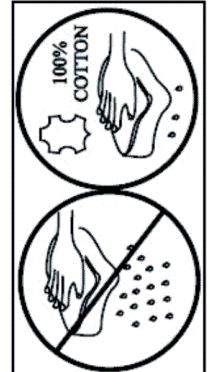
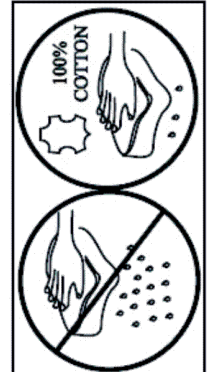
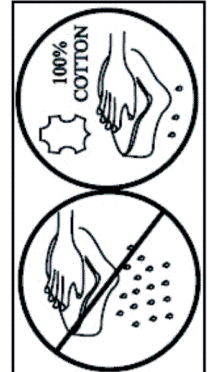
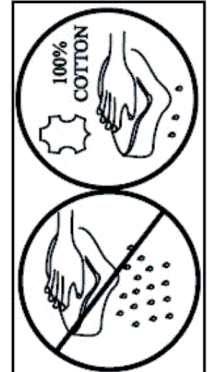
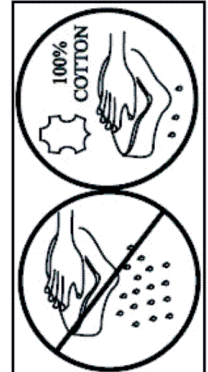
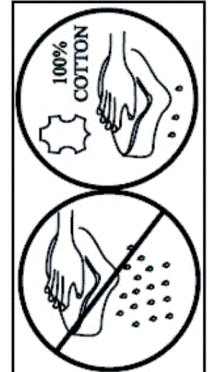
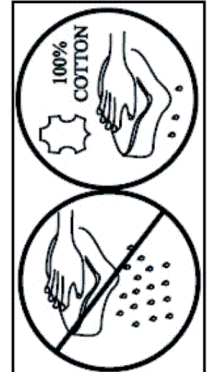
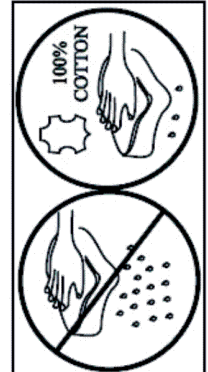
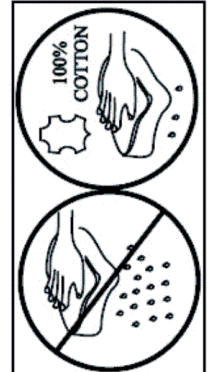
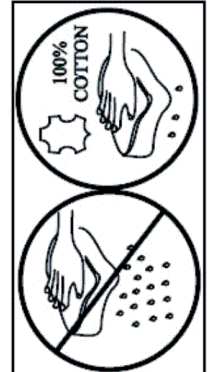
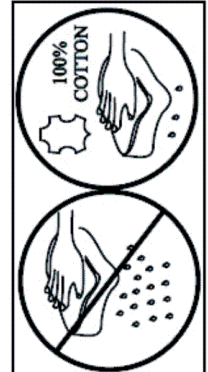
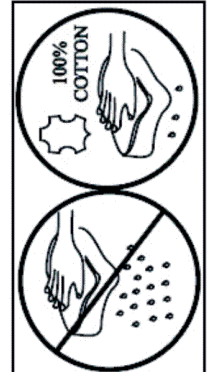
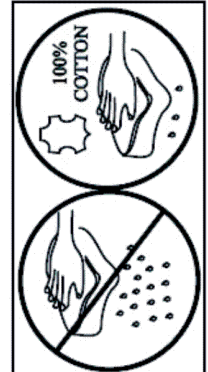
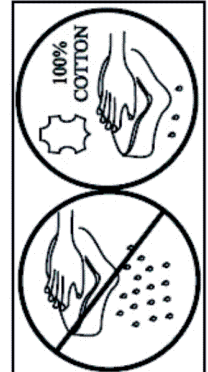
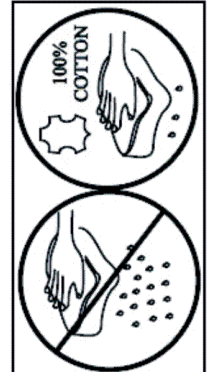
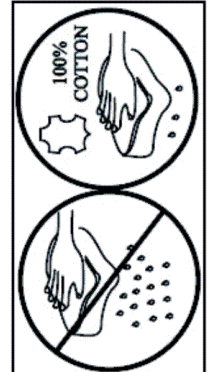
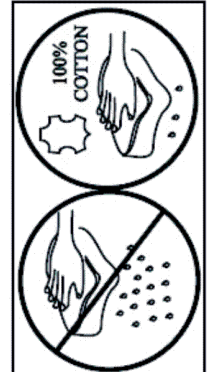
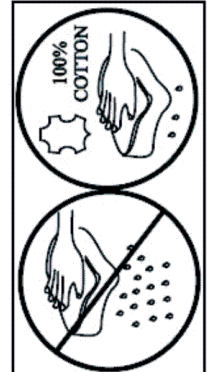
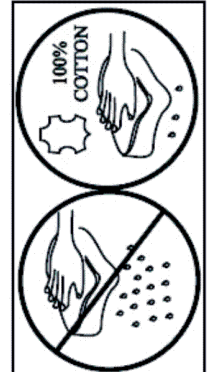
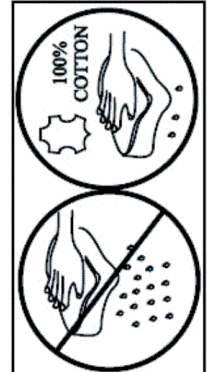
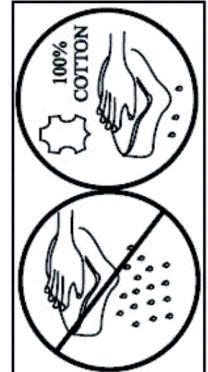
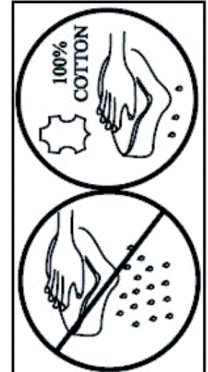
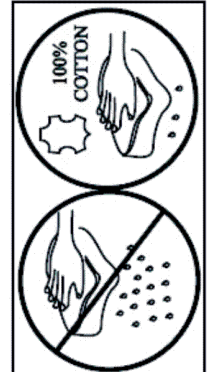
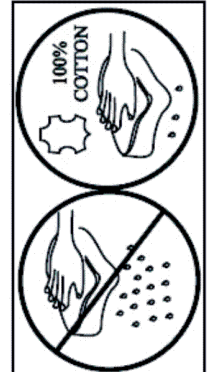
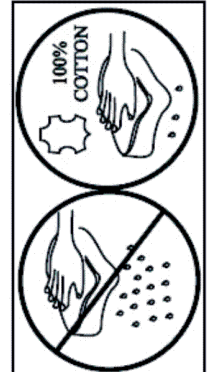
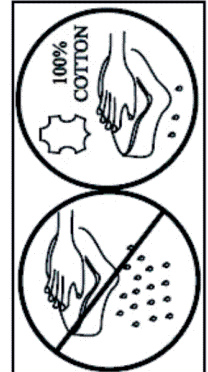
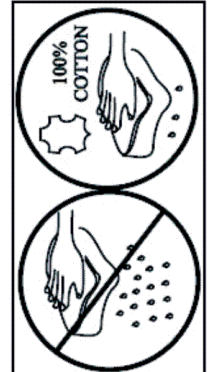
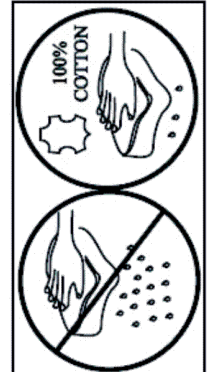
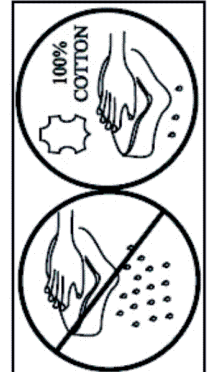
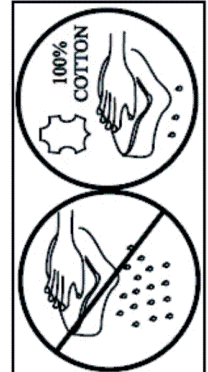
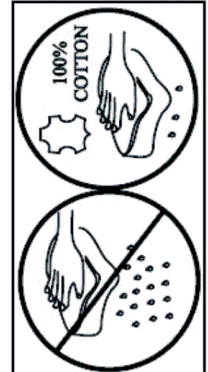
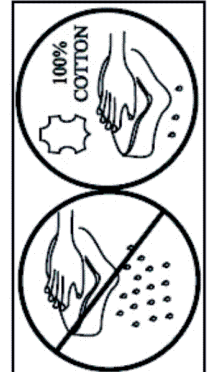
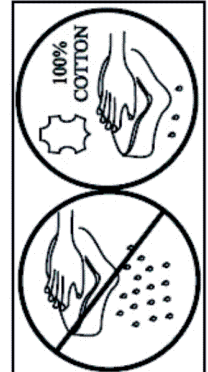
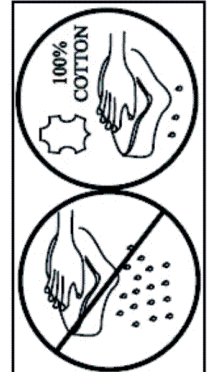
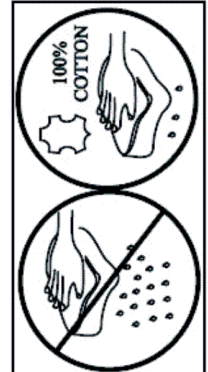
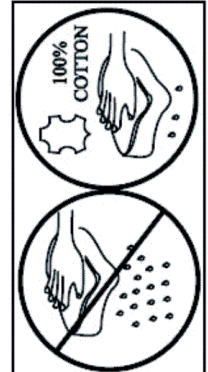
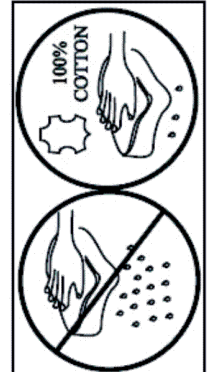
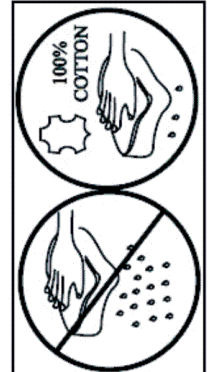
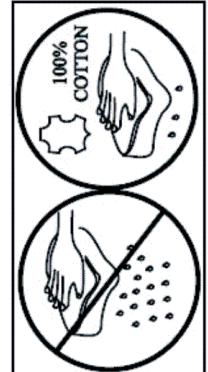
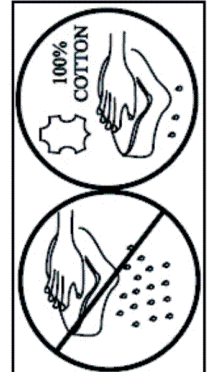
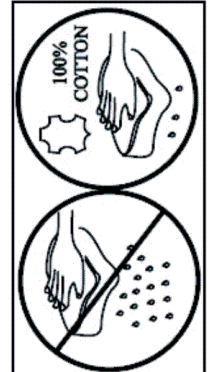
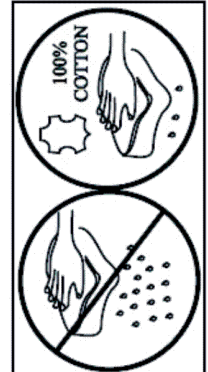
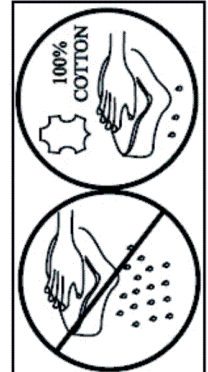
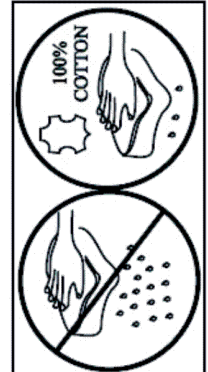
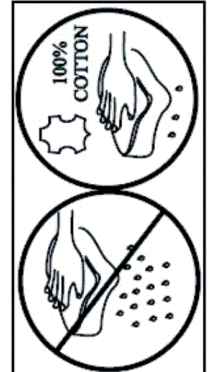
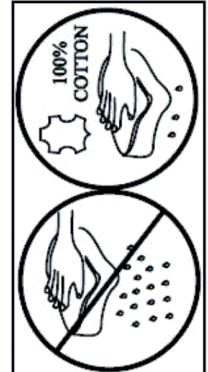
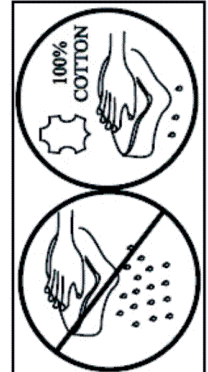
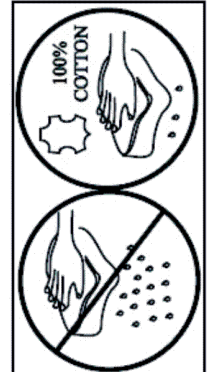
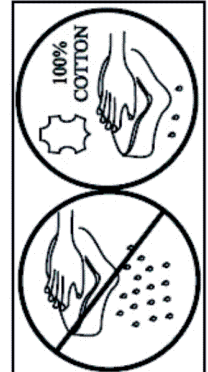
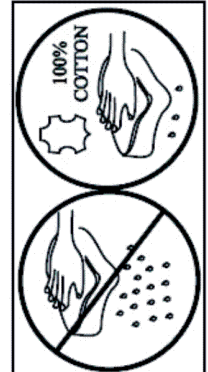
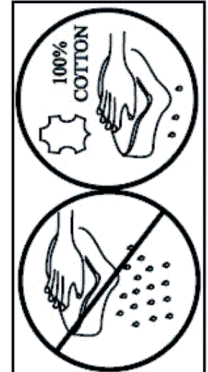
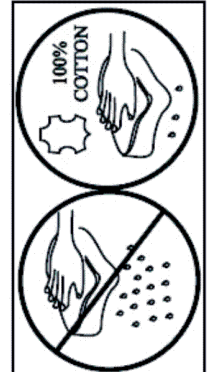
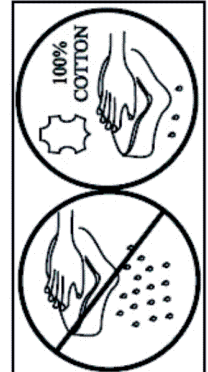
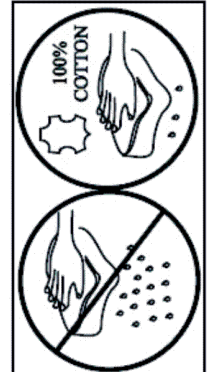
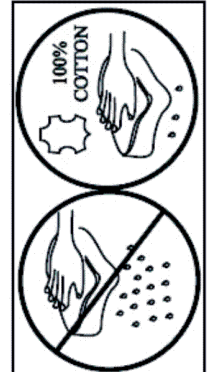
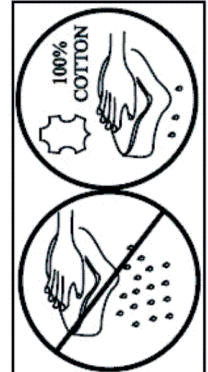
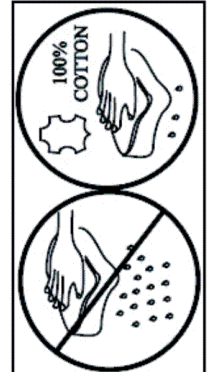
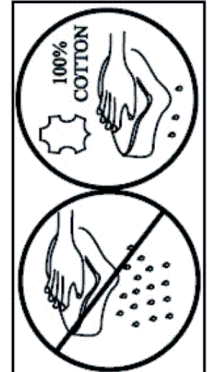
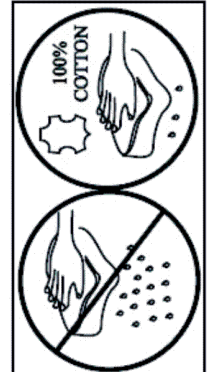
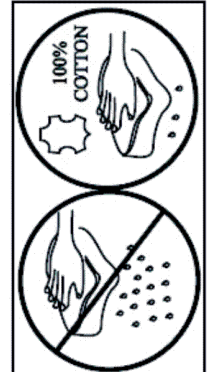
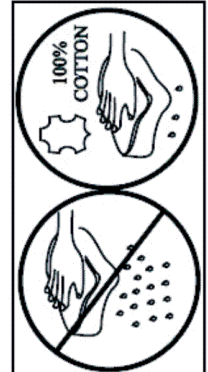
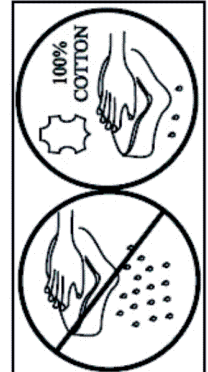
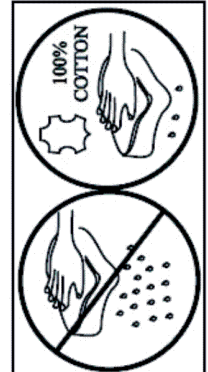
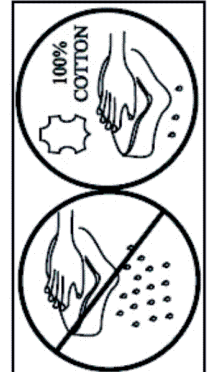
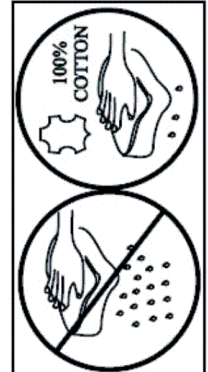
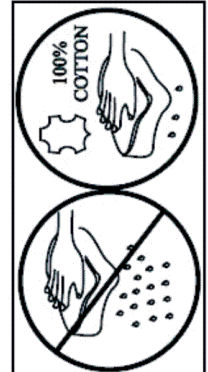
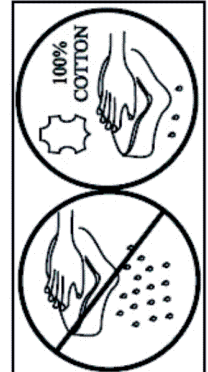
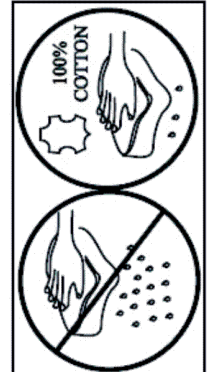
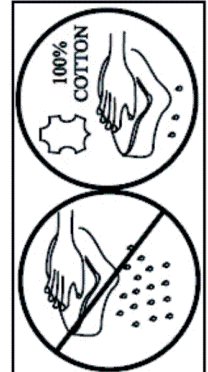
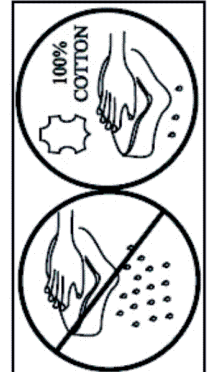
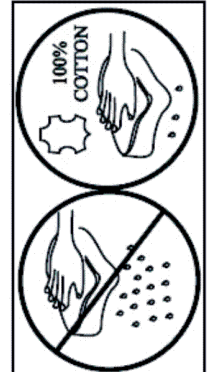
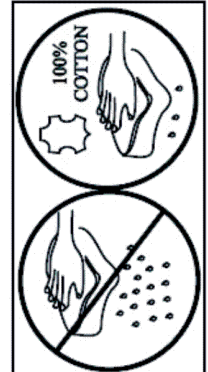
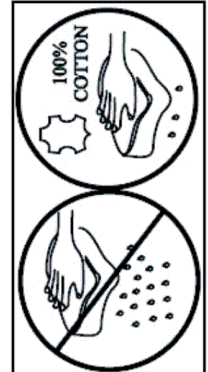
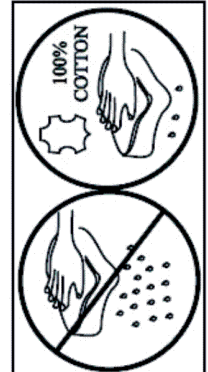
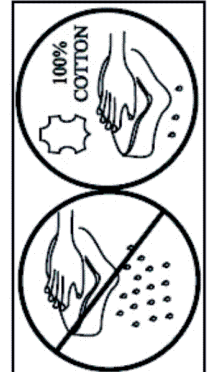
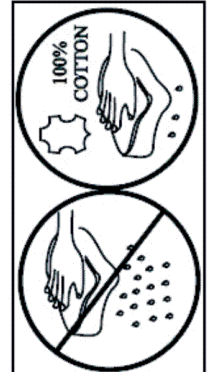
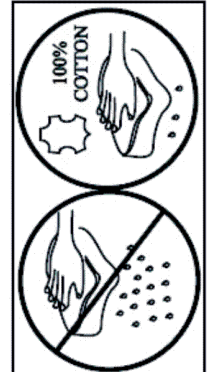
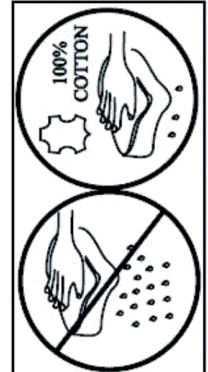
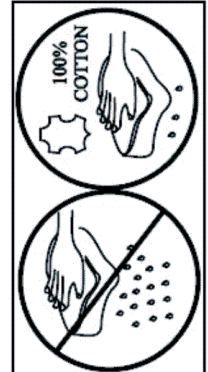
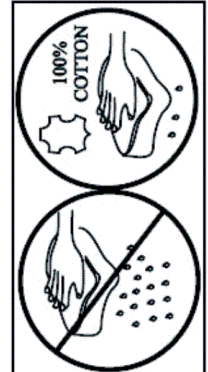
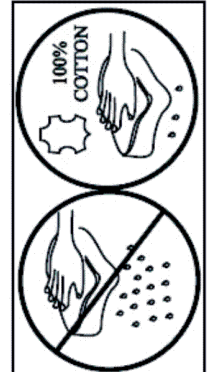
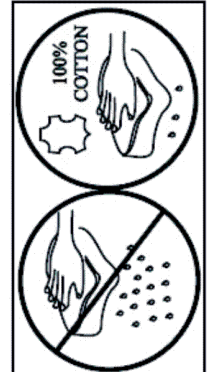
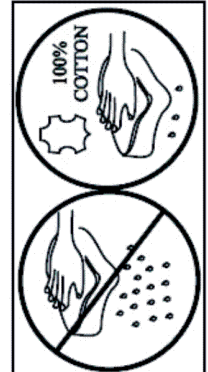
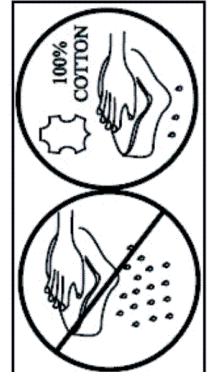
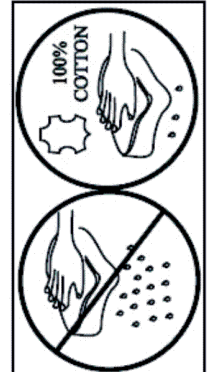
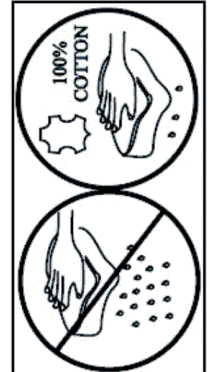
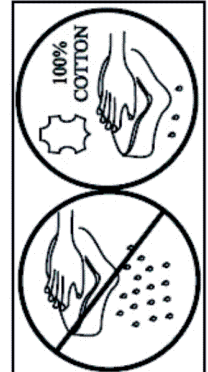
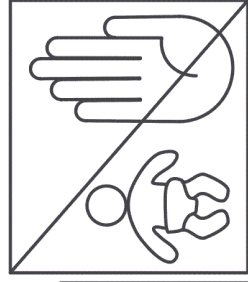
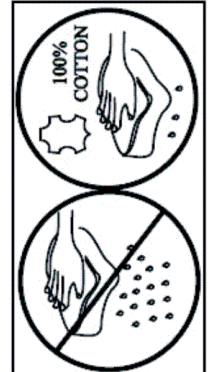
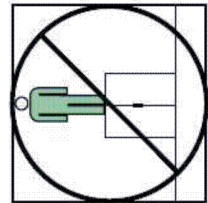
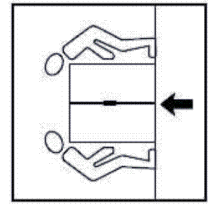
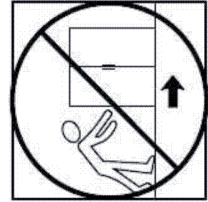
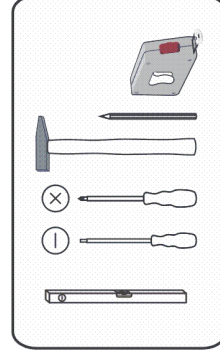
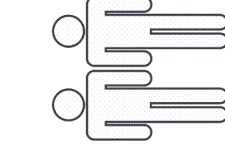
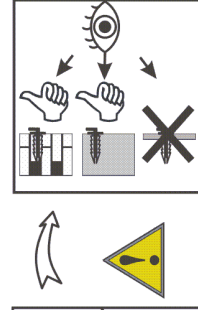
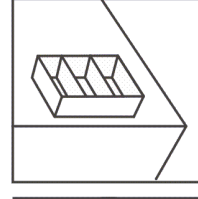
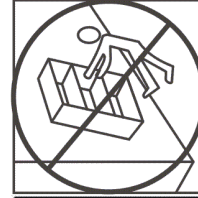
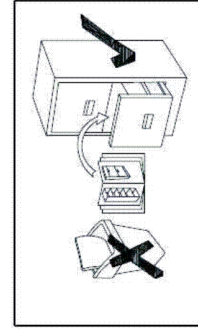
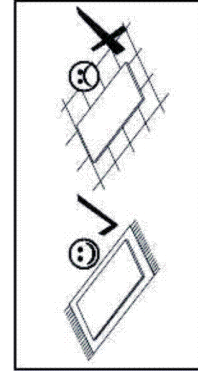

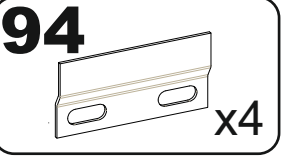
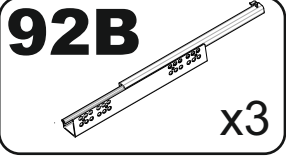
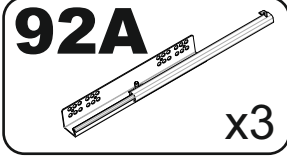
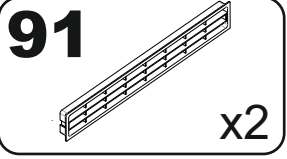
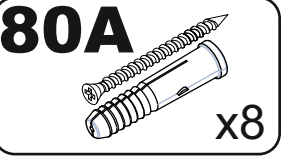
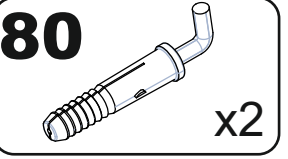
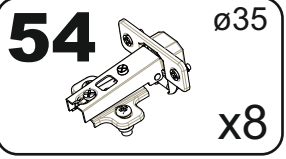
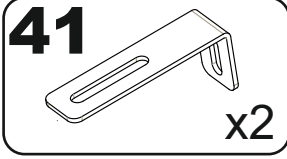
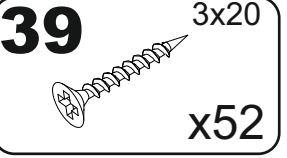
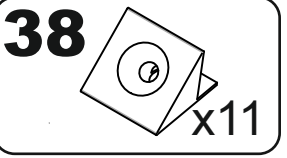
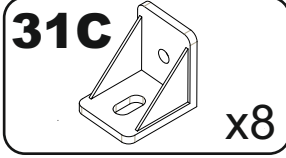
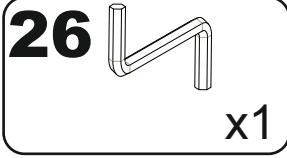
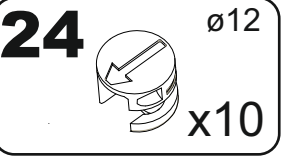
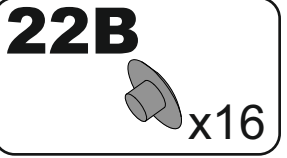
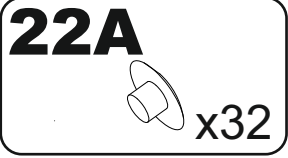
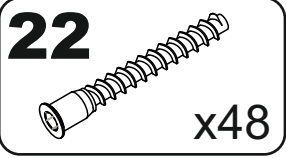
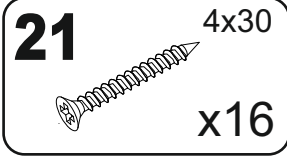
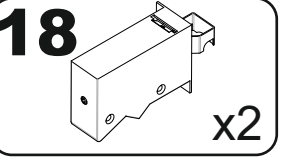
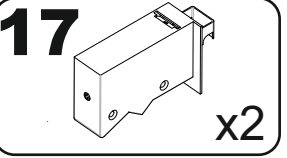
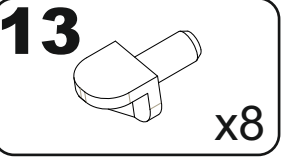
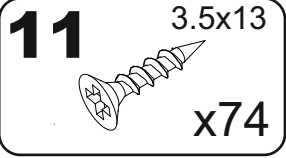
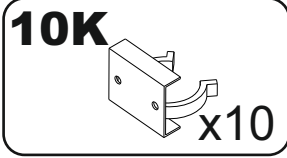
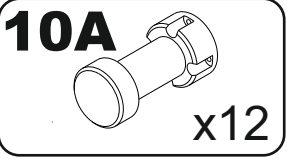
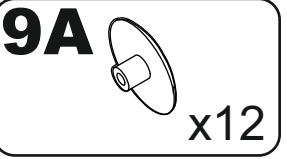
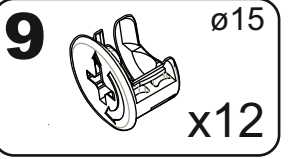
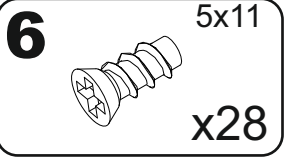
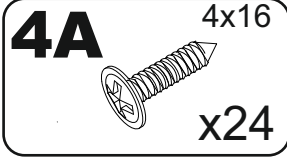
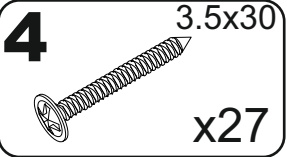
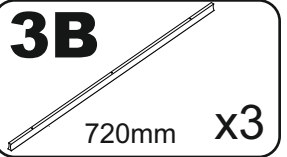
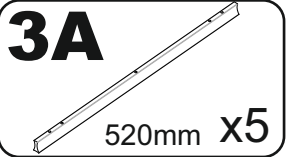
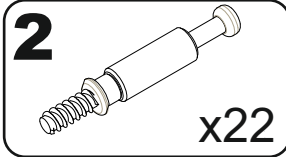
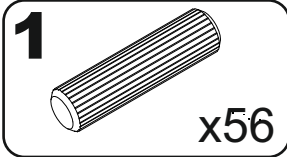
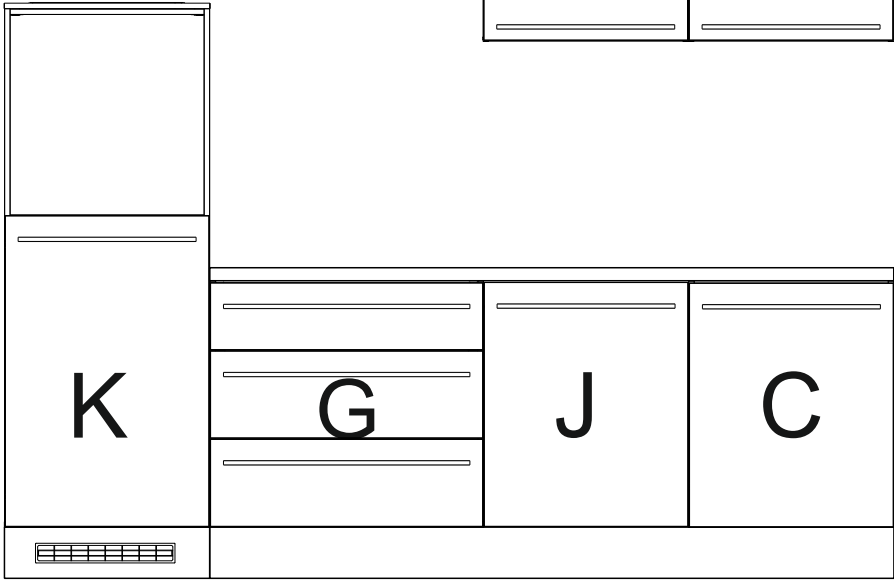
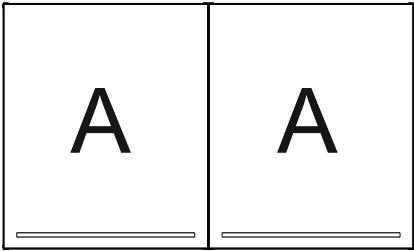
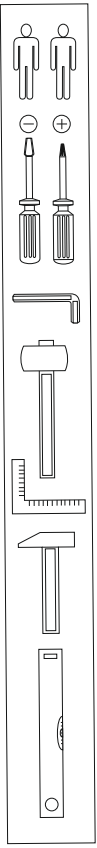

A

x2

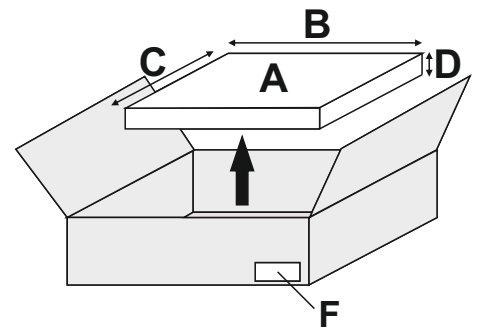
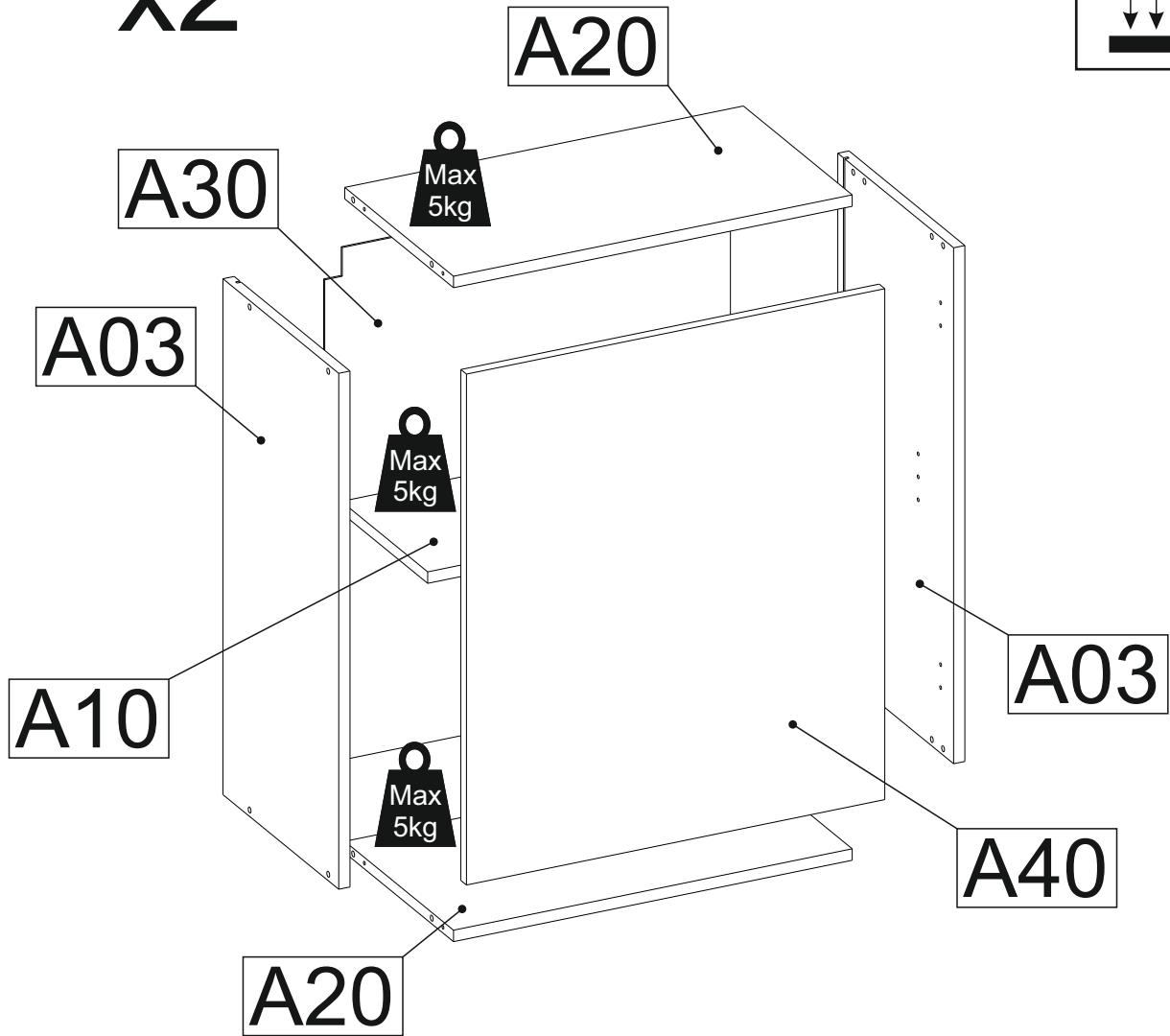
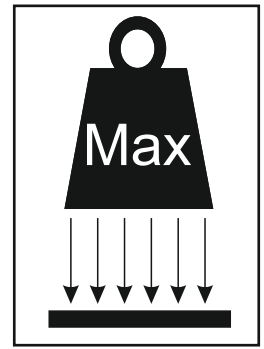

A	B (mm)	C (mm)	D (mm)	E	F
A03	720	330	16	2	1 7
A10	568	246	16	1	1 7
A20	568	310	16	2	2 7
A30	715	578	3	1	2 7
A40	713	596	16	1	2 7

1

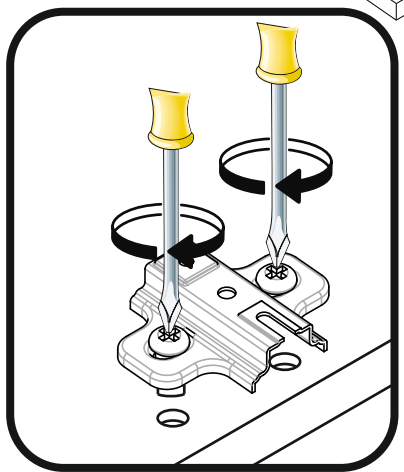
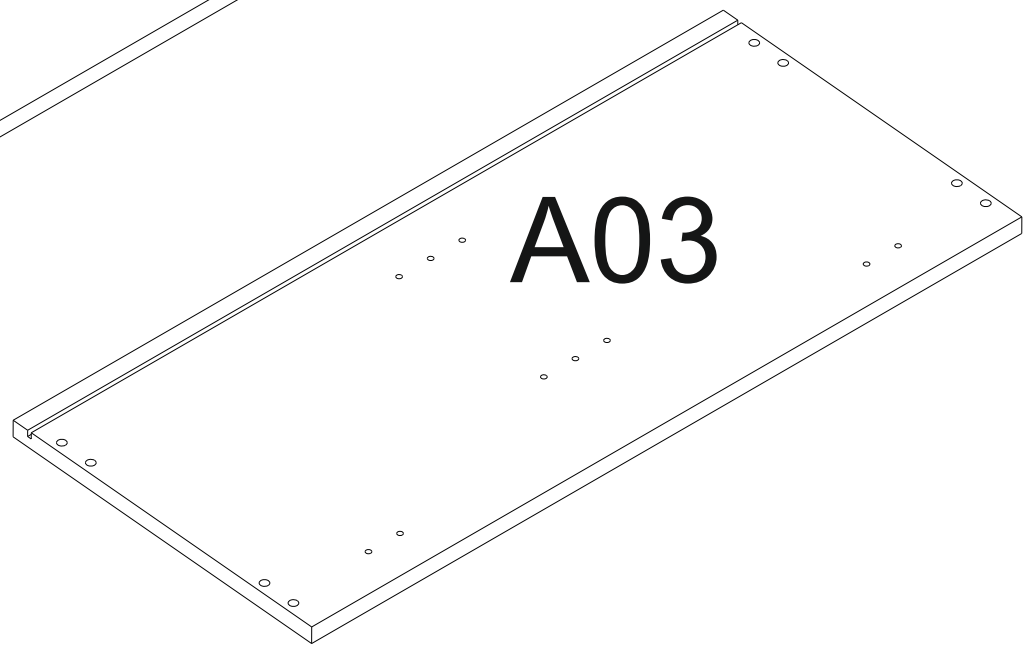
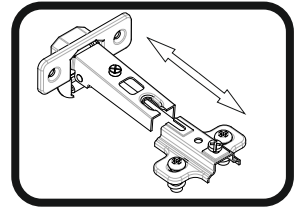
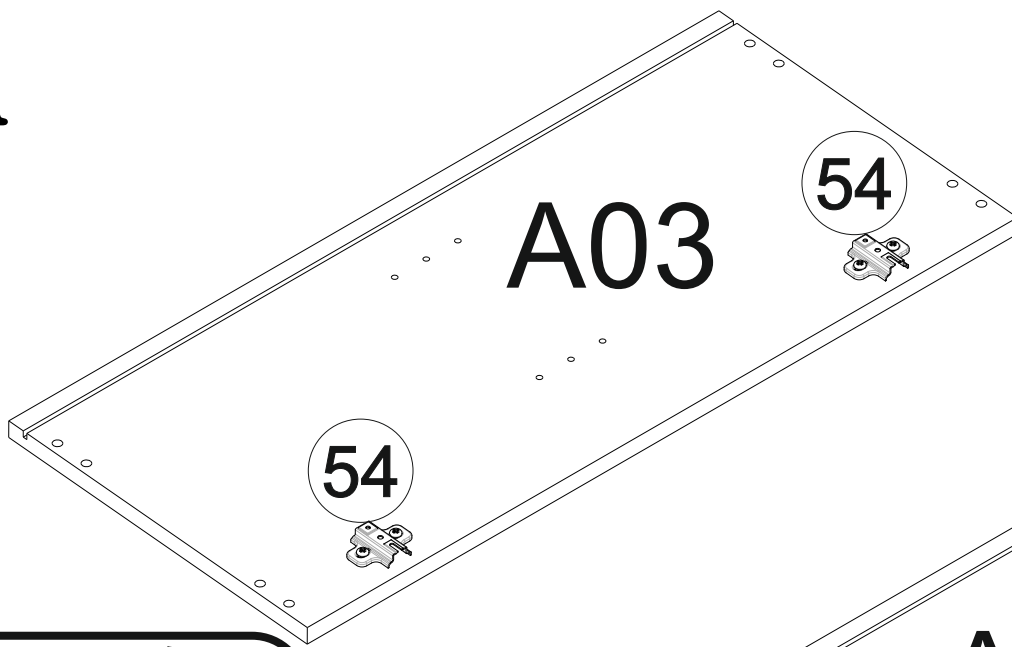

2

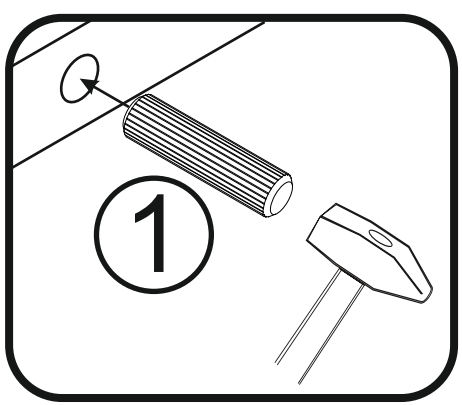
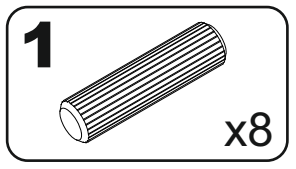
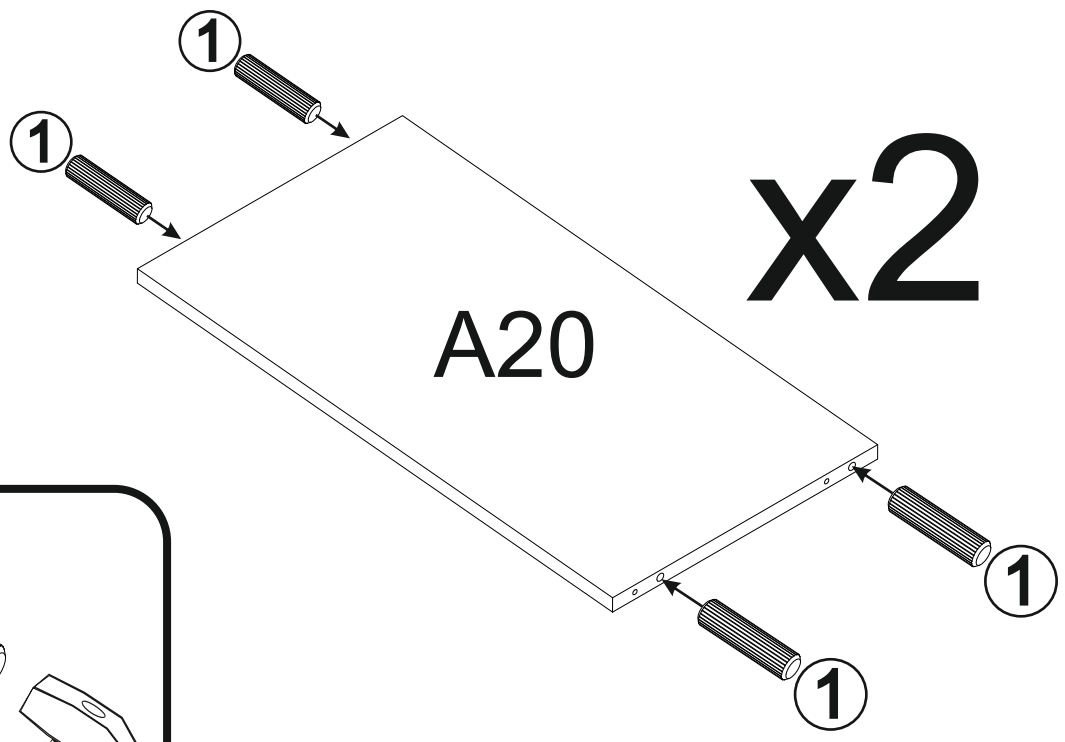

3

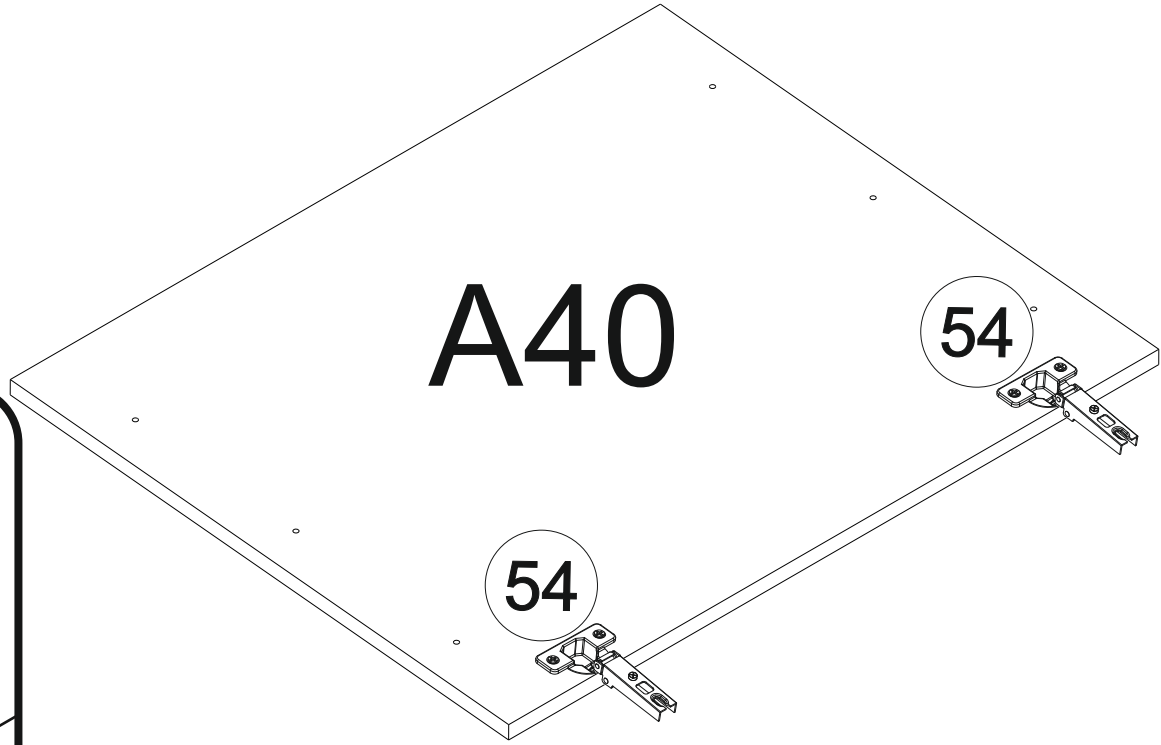
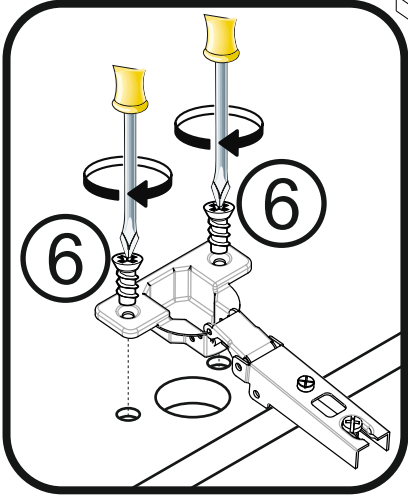
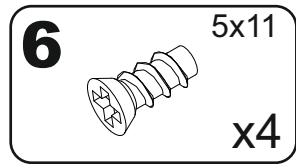
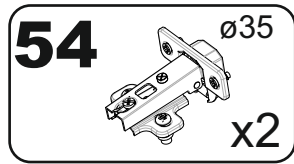

4

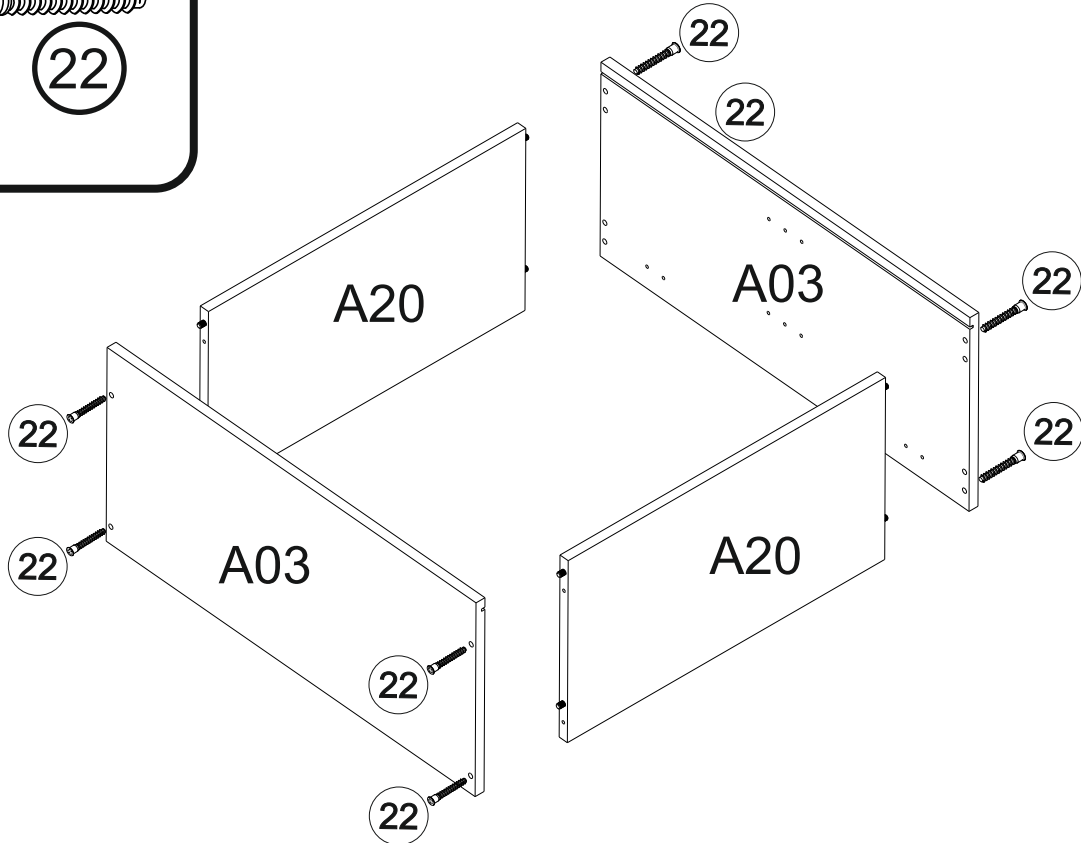
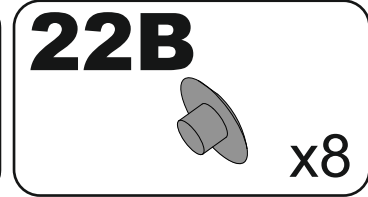
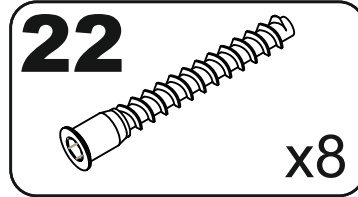
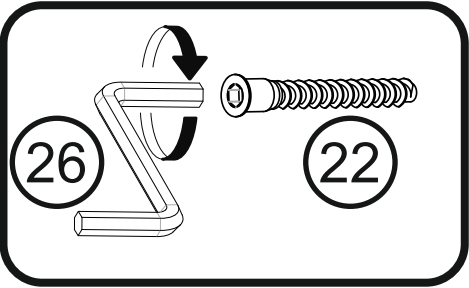

5

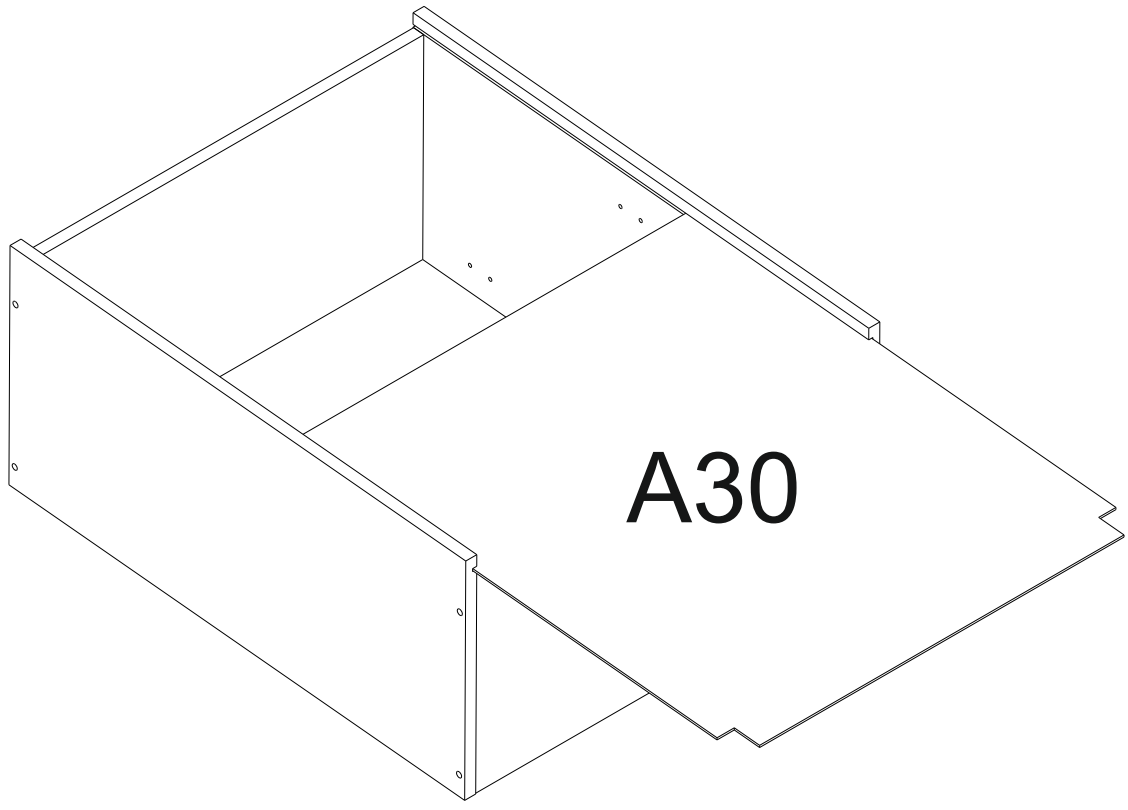

A30

6

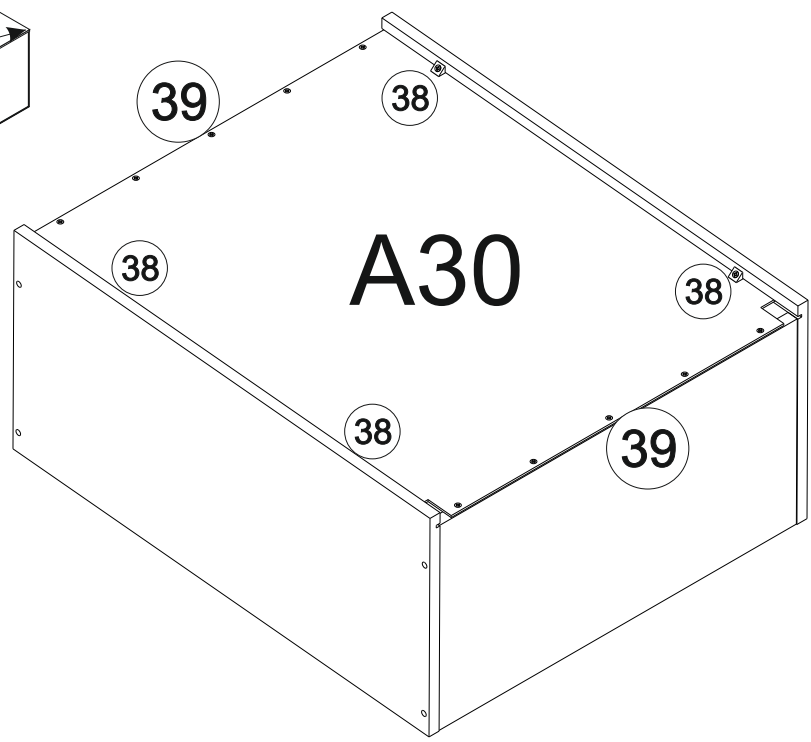
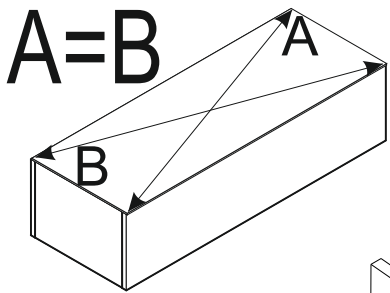
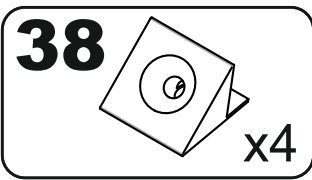
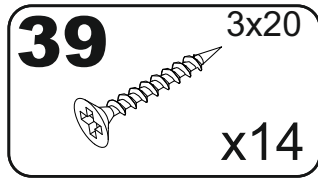

A30

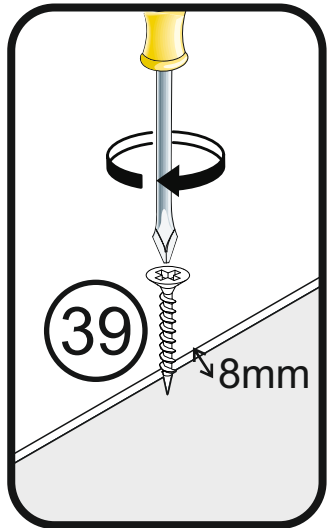
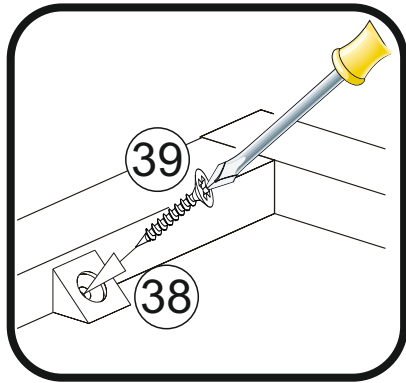

7

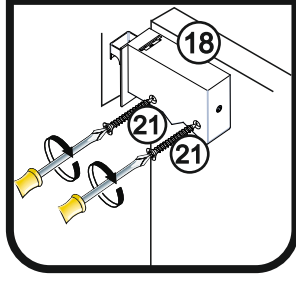
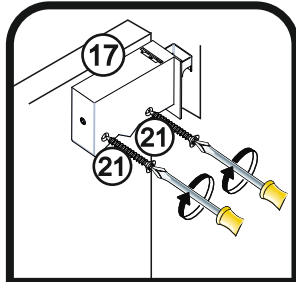
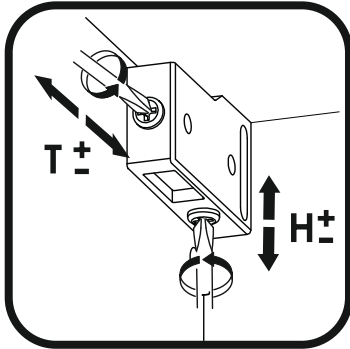
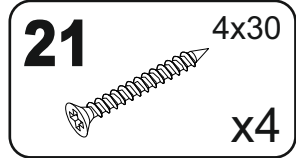
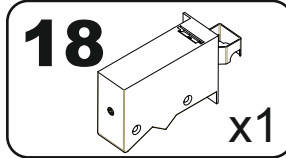
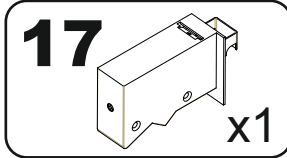
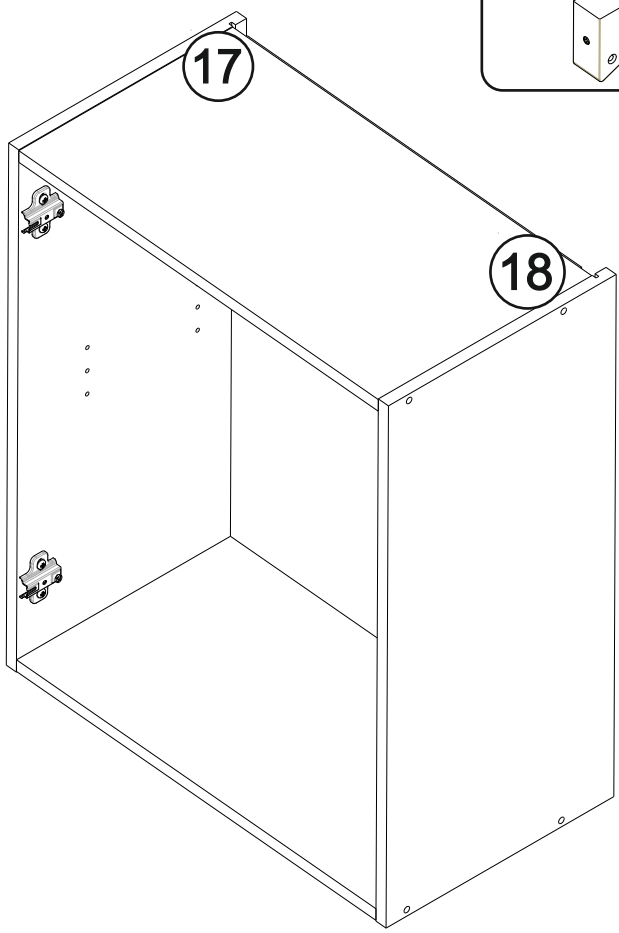

8

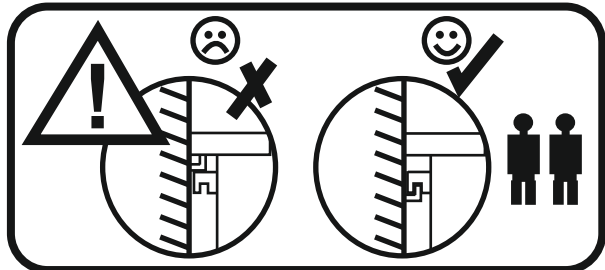
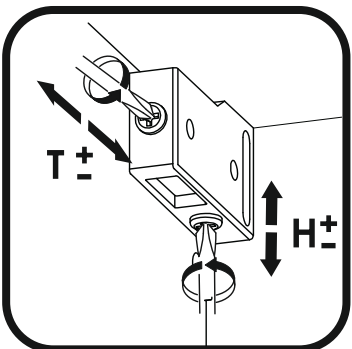
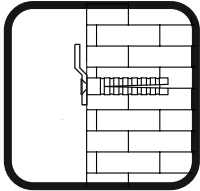
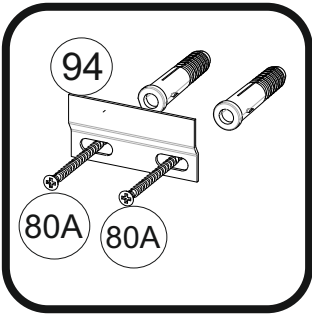
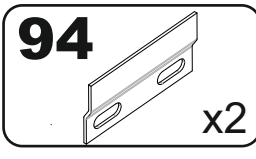
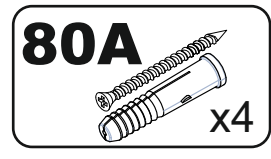
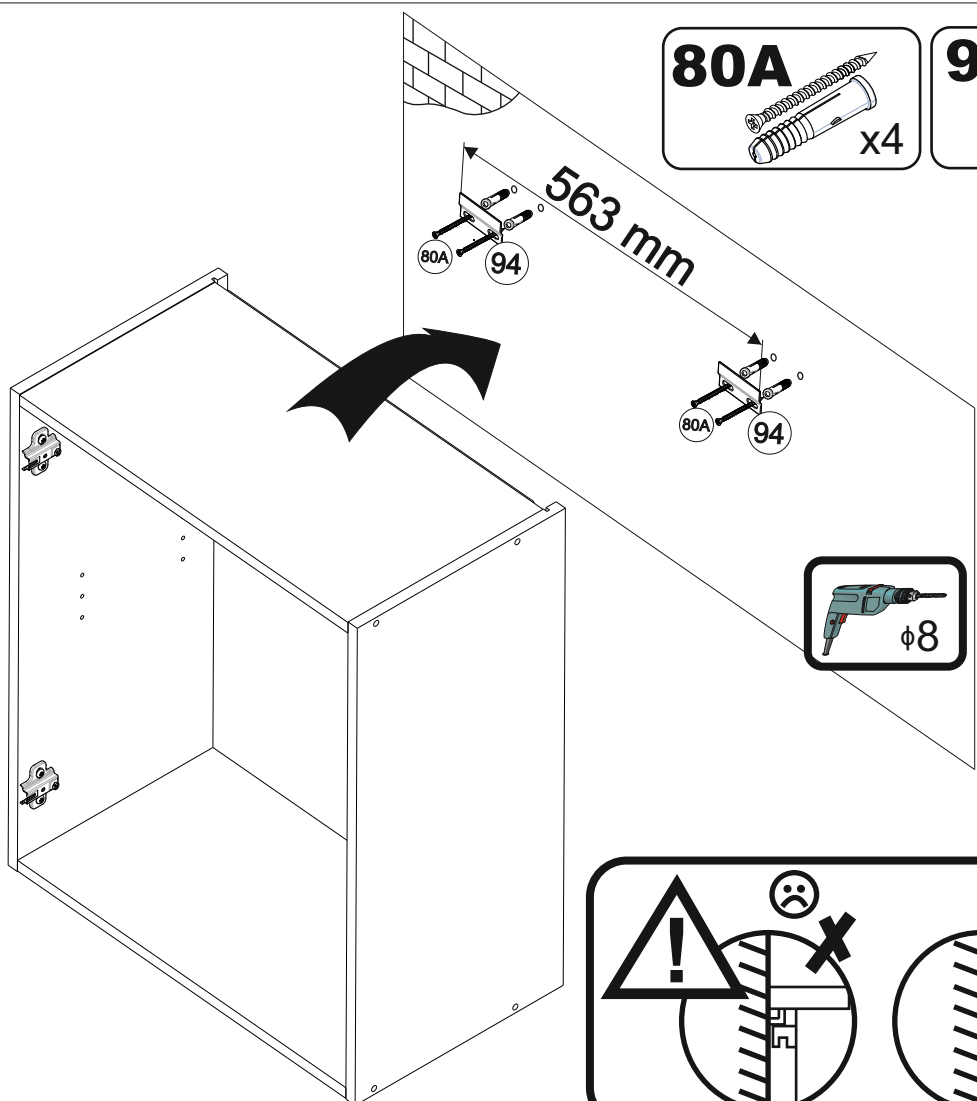

9

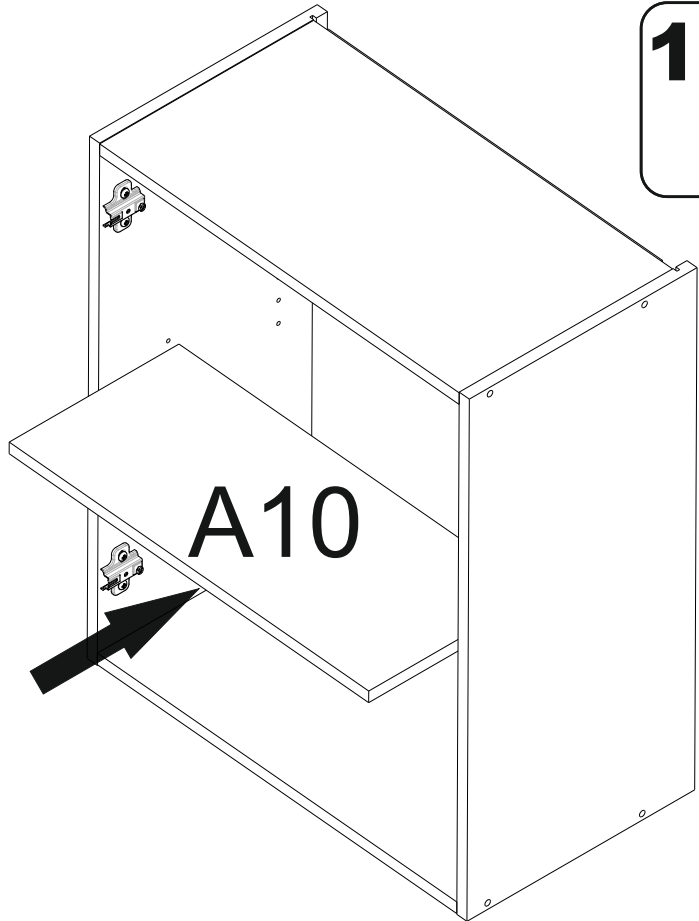
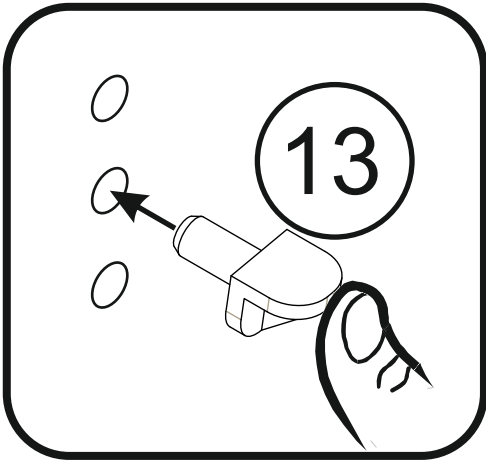
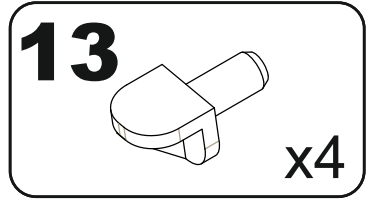

10

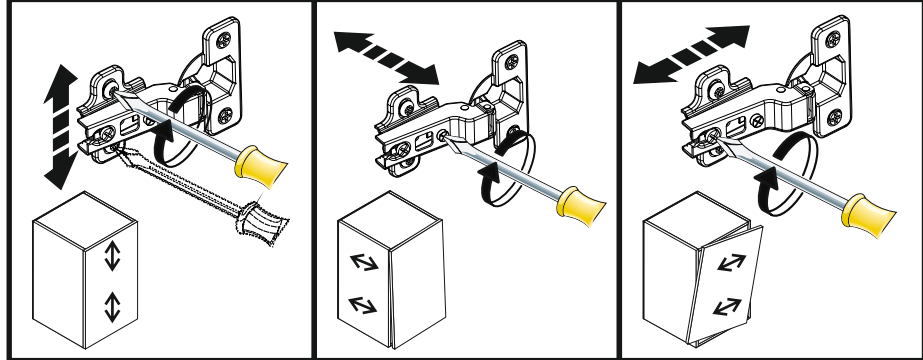
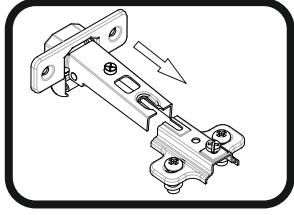
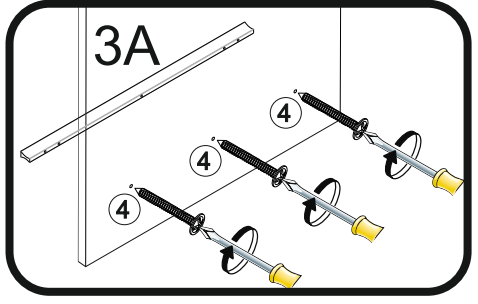
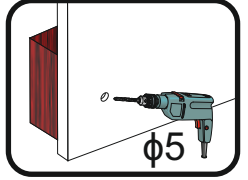
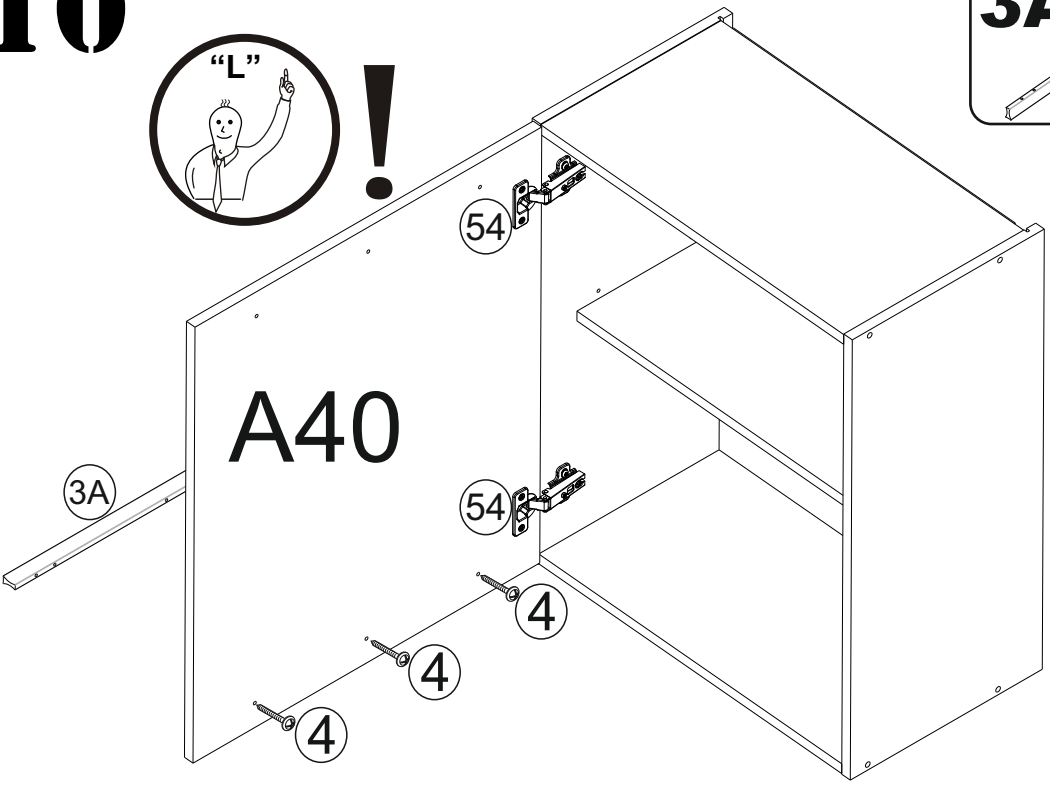
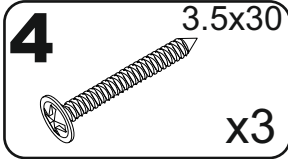
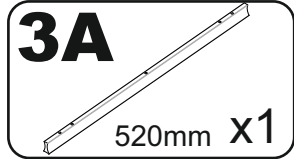

C

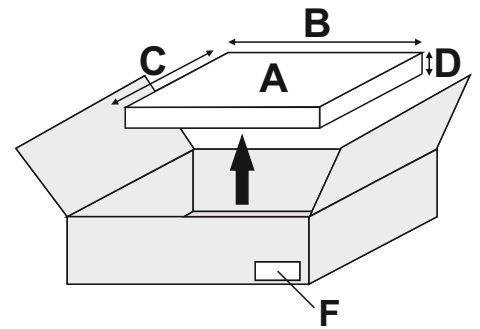
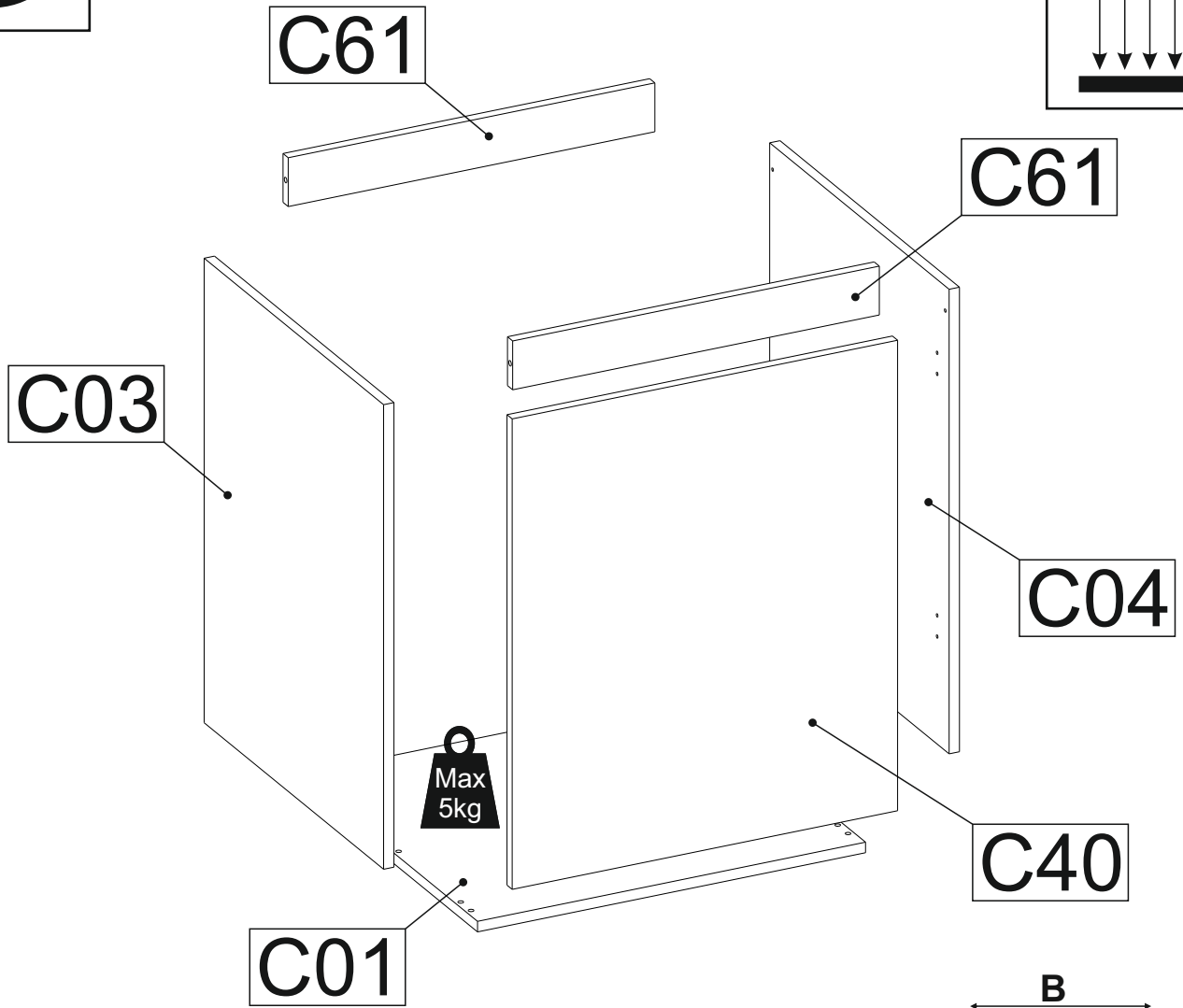
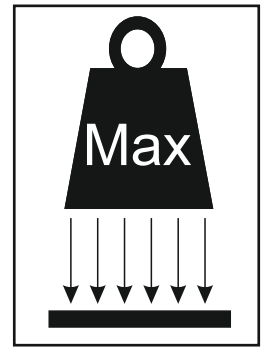

A	B_(mm)	C_(mm)	D_(mm)	E	F
C01	600	555	16	1	3 7
C03	704	555	16	1	3 7
C04	704	555	16	1	3 7
C40	713	596	16	1	3 7
C61	567	74	16	2	3 7

1

"R"!

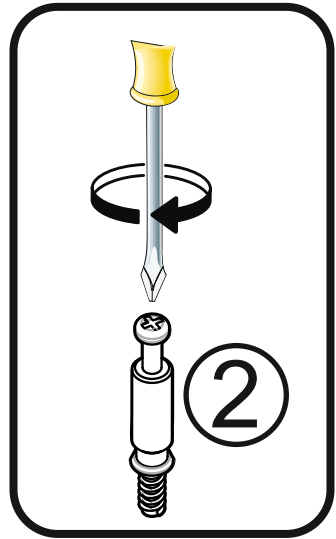
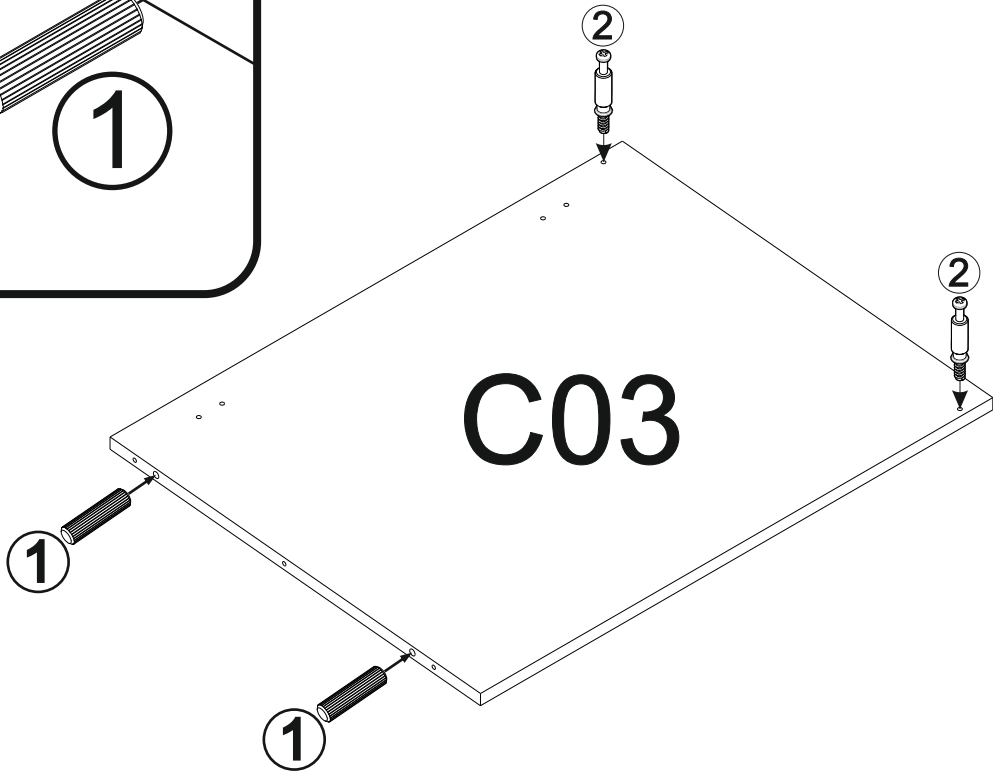
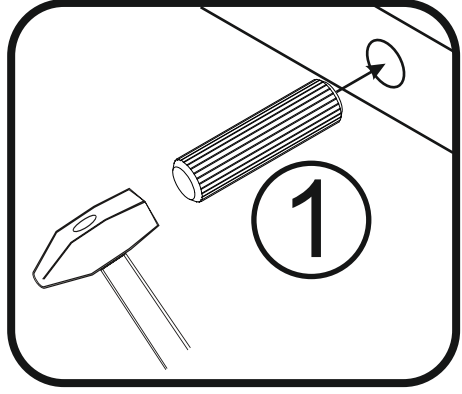
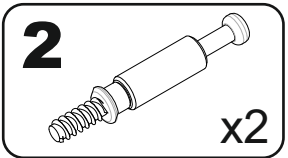
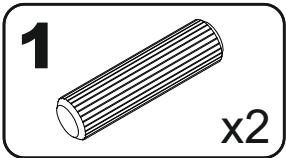

2

"R"!

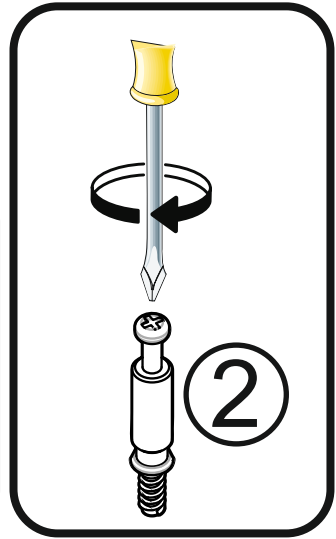
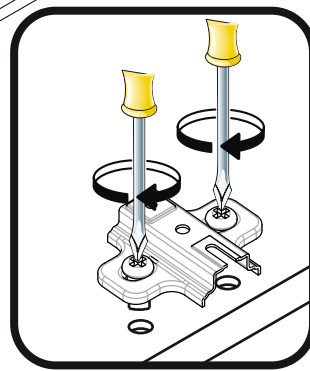
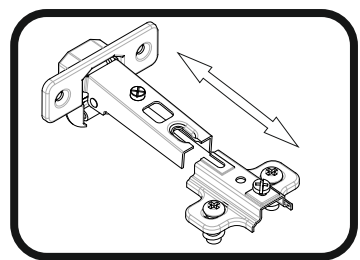
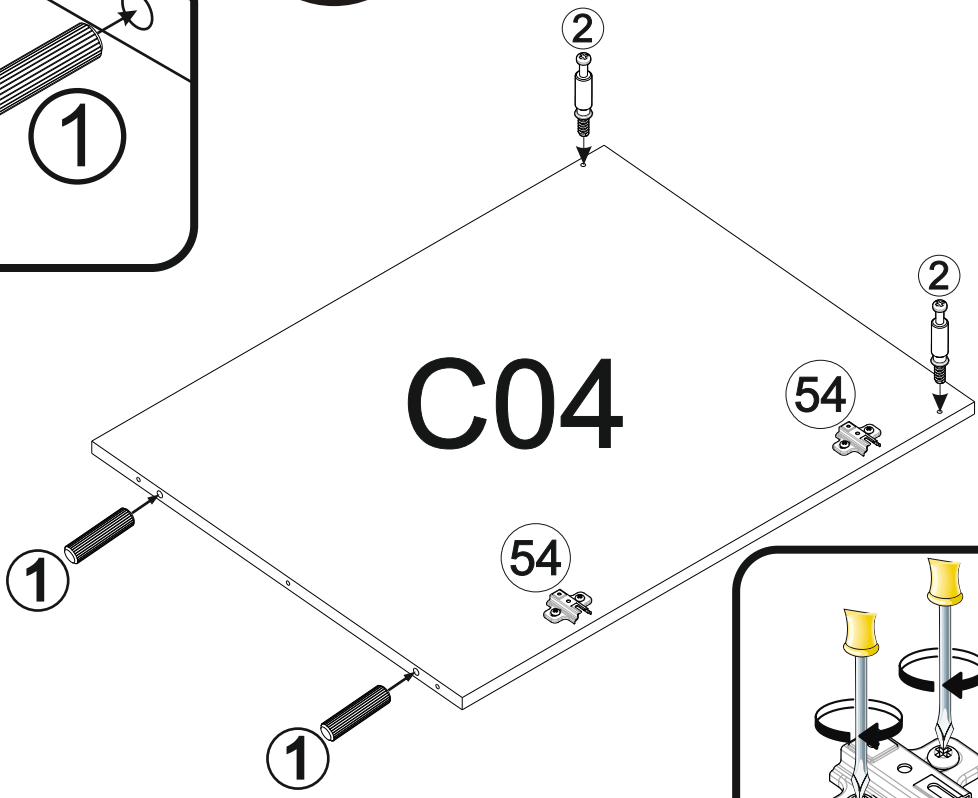
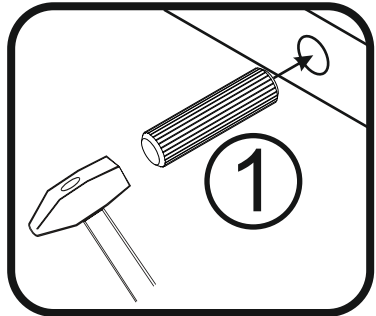
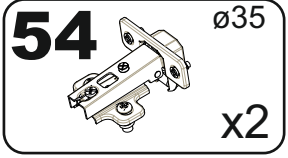
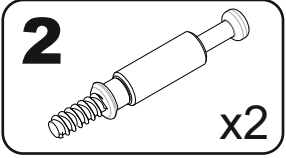
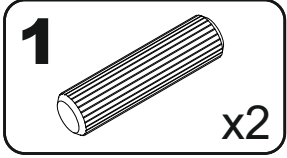

3

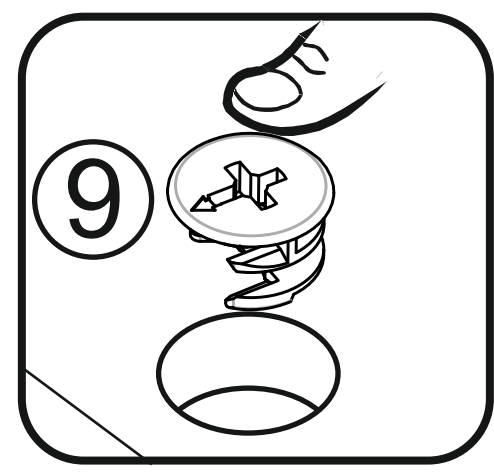
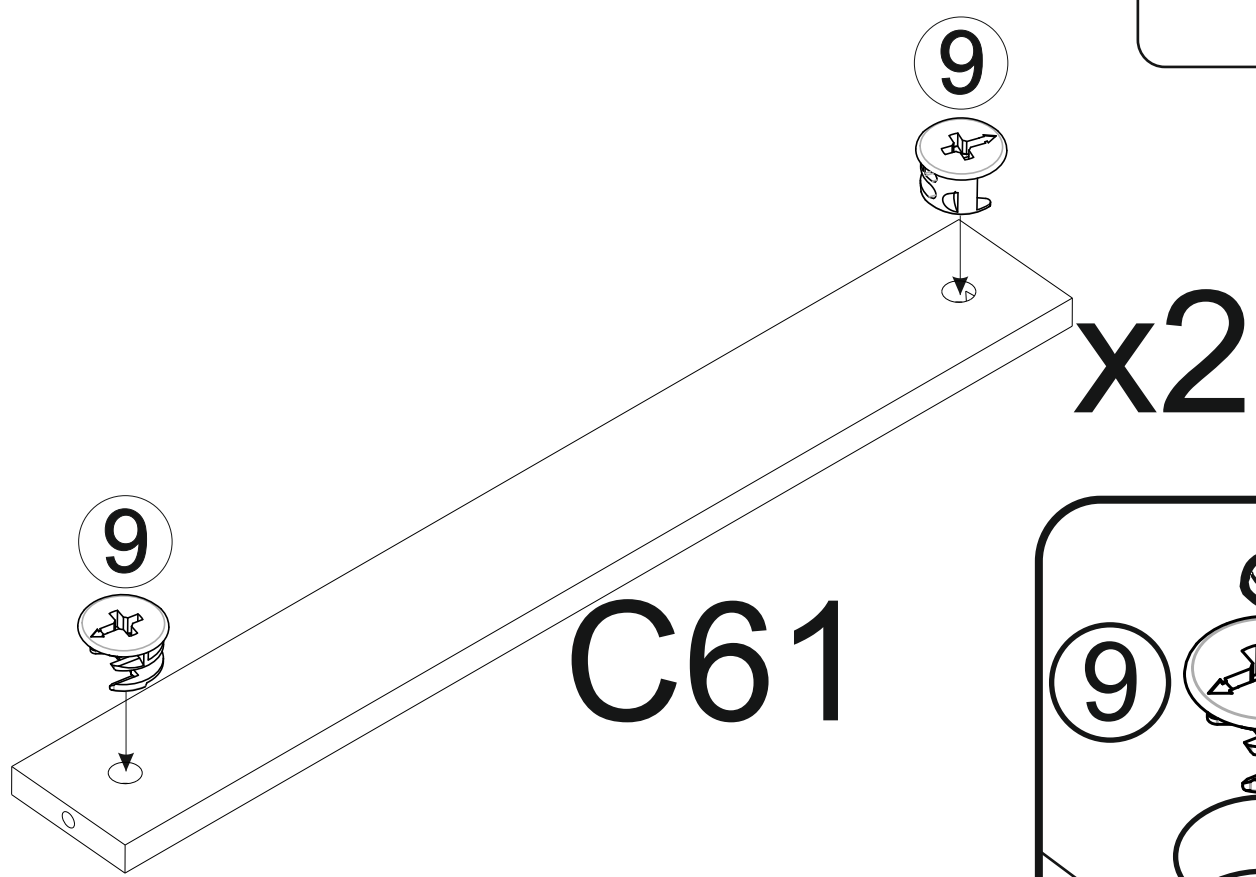
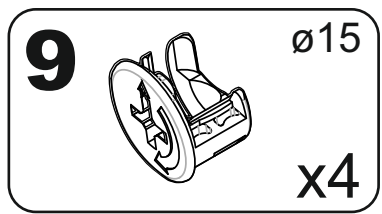

4

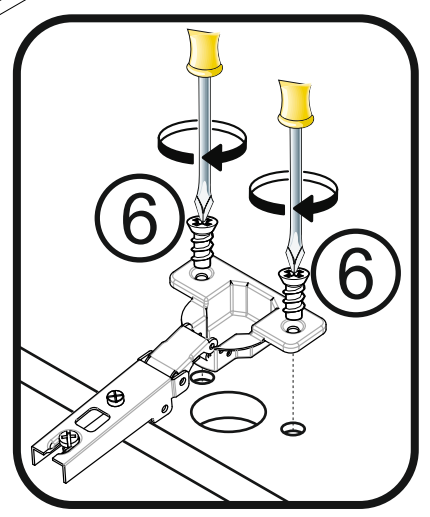
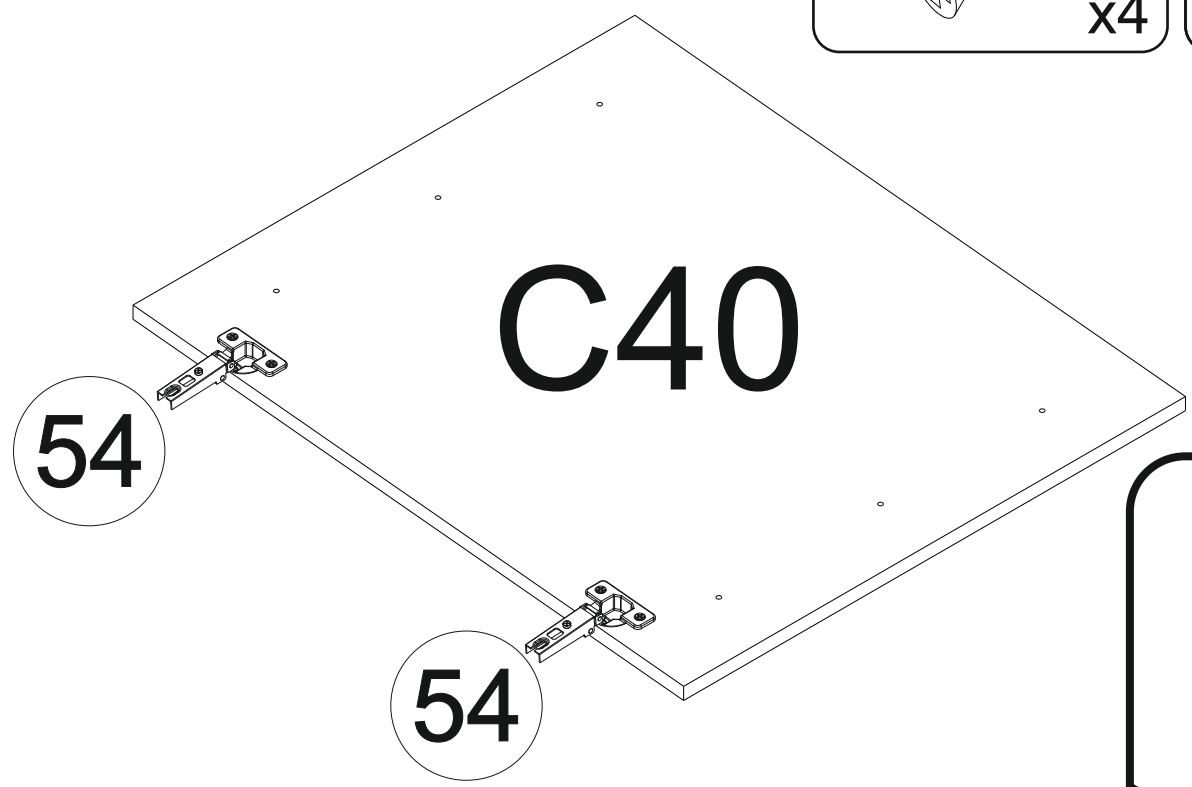
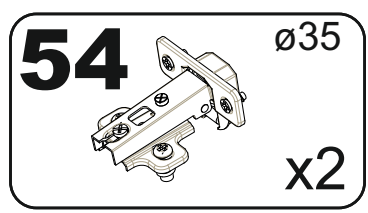
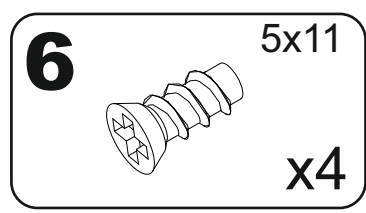

5

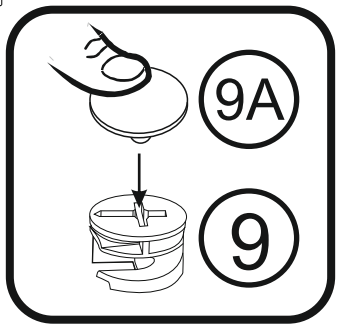
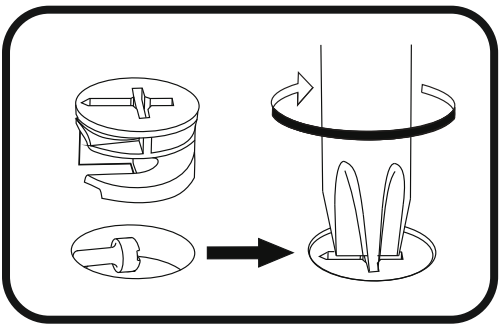
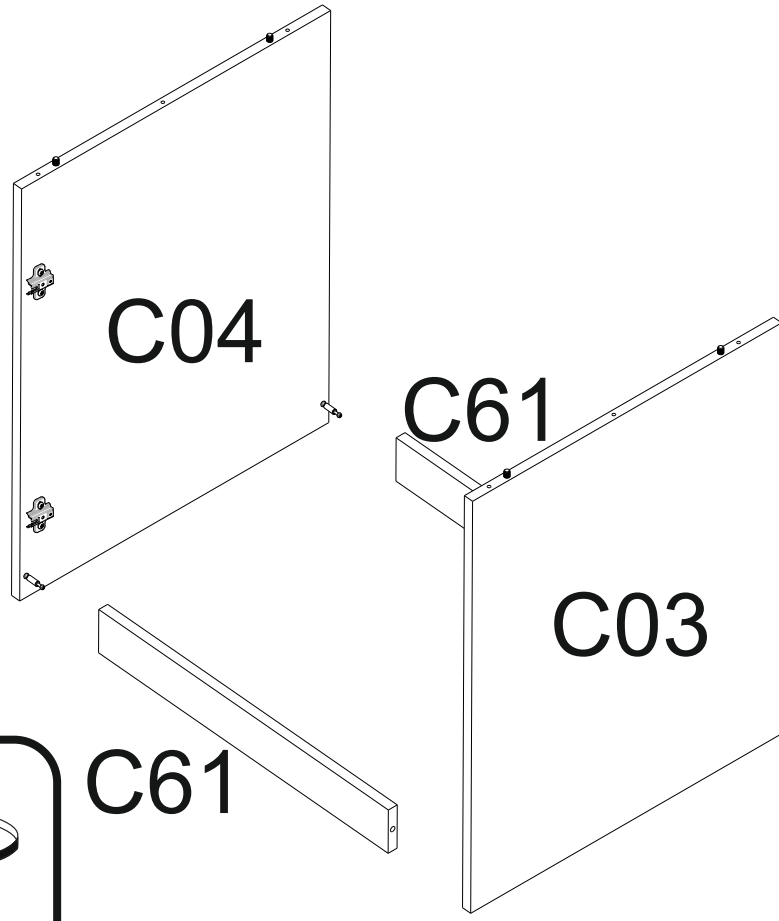
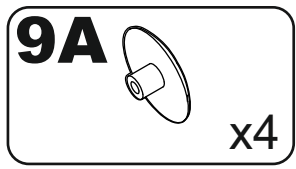

6

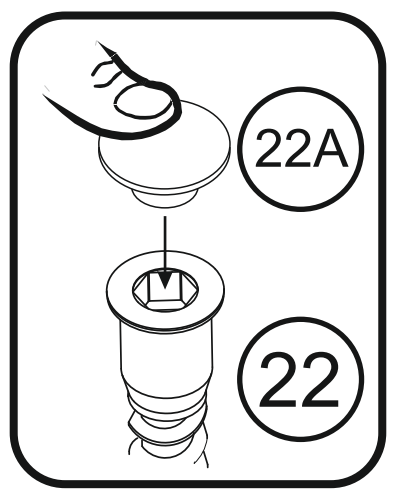
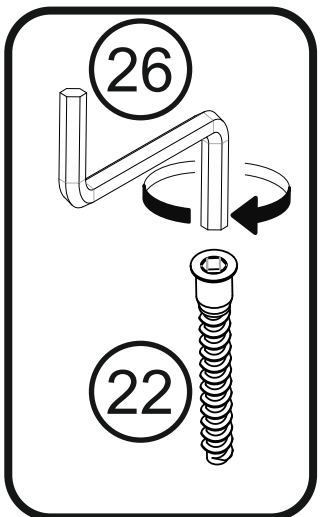
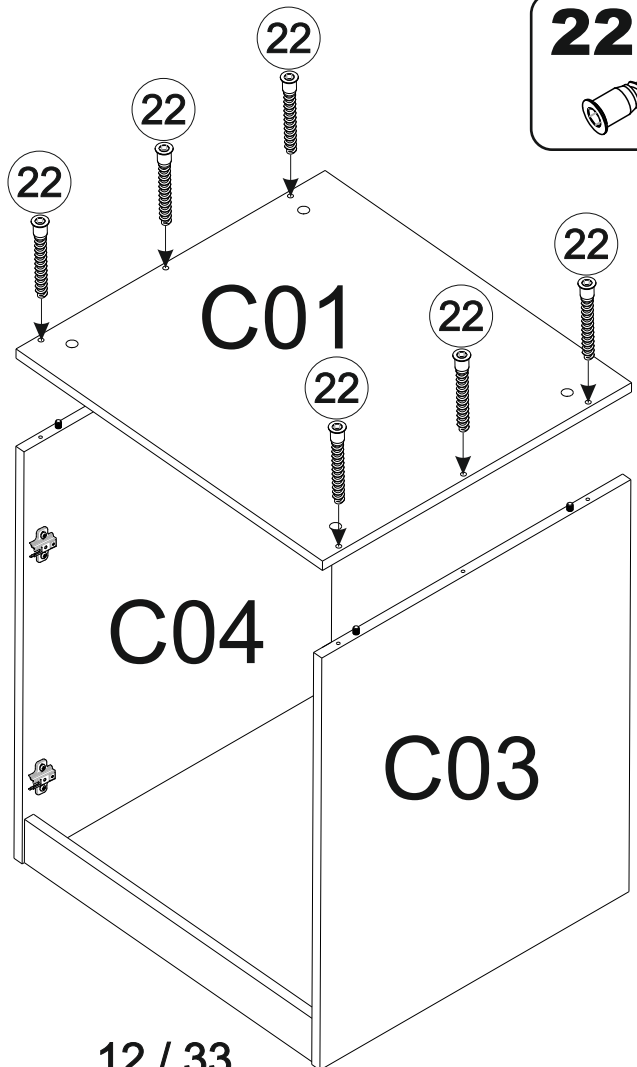
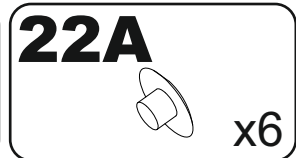
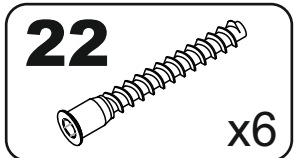

7

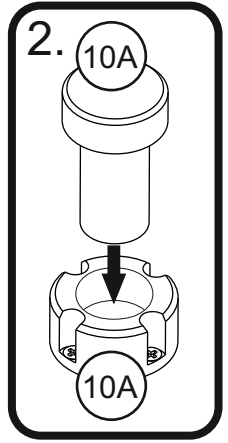
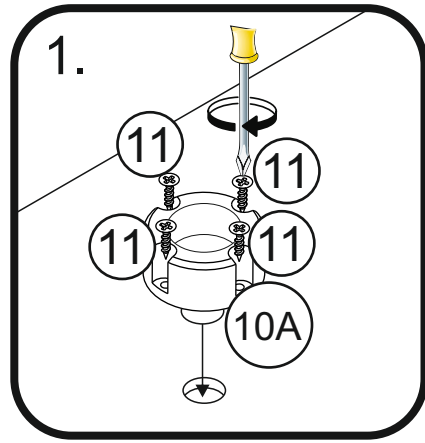
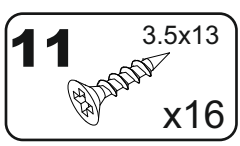
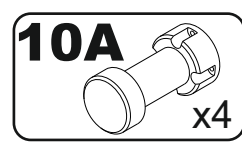
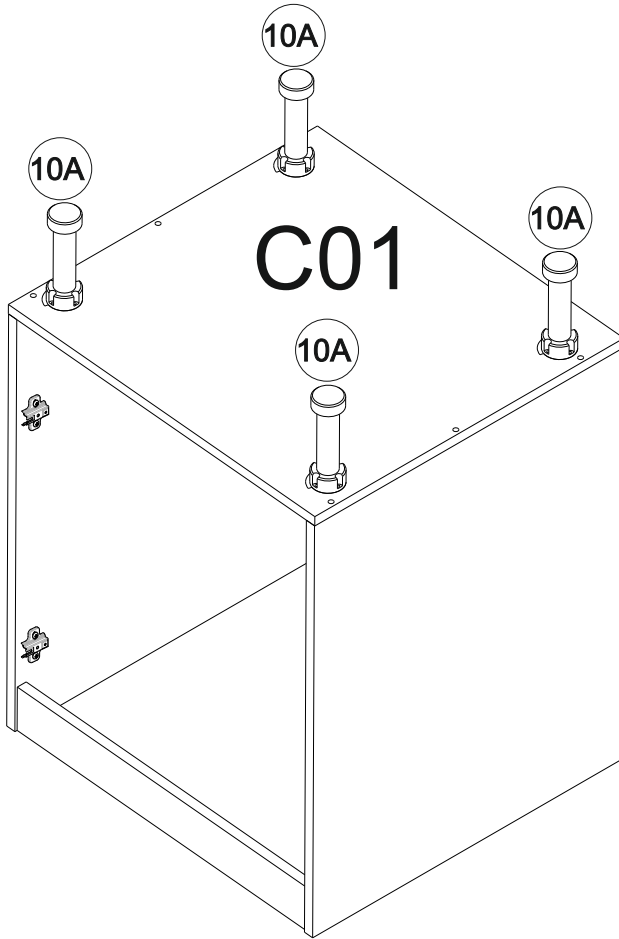

8

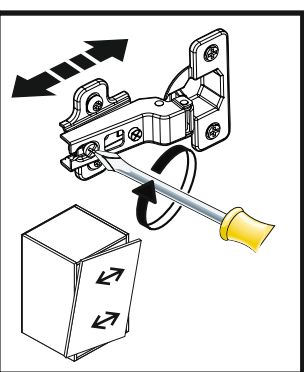
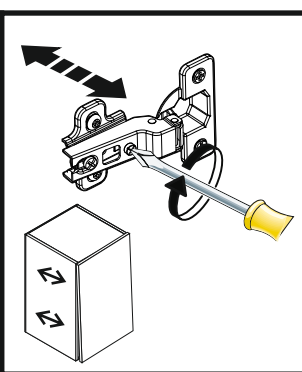
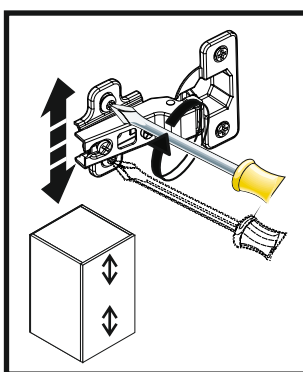
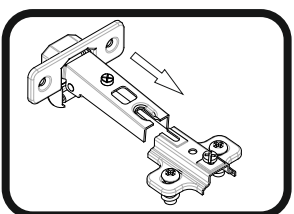
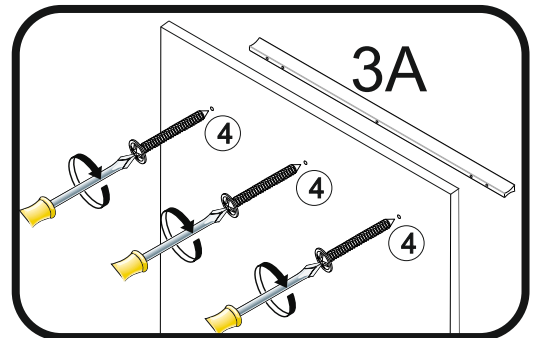
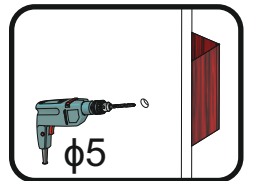
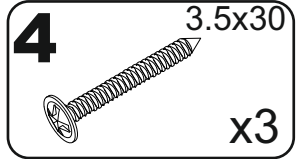
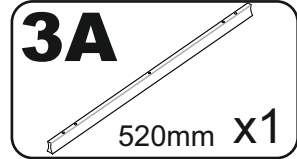
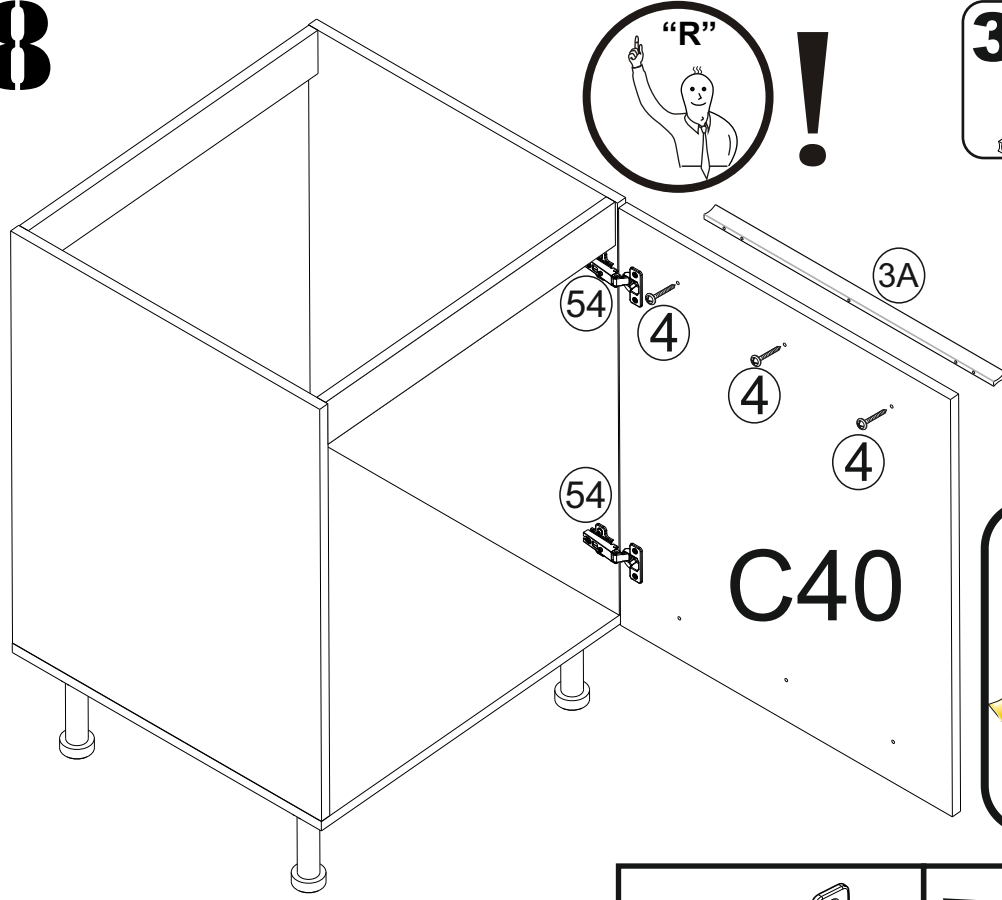

G

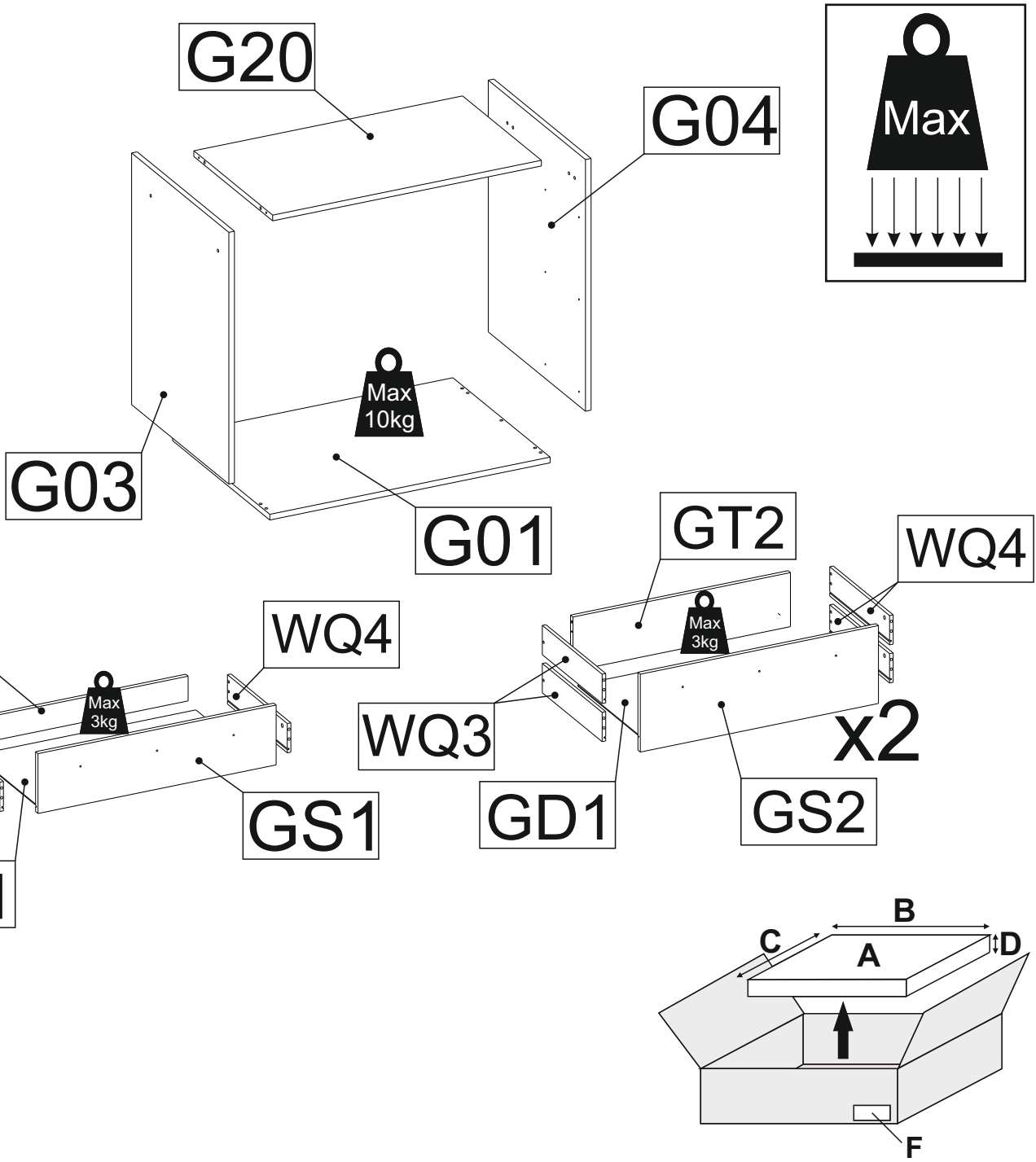

A	B (mm)	C (mm)	D (mm)	E	F
G01	800	555	16	1	4 7
G03	704	555	16	1	4 7
G04	704	555	16	1	4 7
G20	767	450	16	1	4 7
GD1	737	403	3	2	4 7
GS1	796	196	16	1	4 7
GS2	796	255	16	1	4 7
GT1	727	81	16	1	4 7
GT2	727	177	16	1	4 7
WQ3	400	96	12	3	4 7
WQ4	400	96	12	3	4 7

1

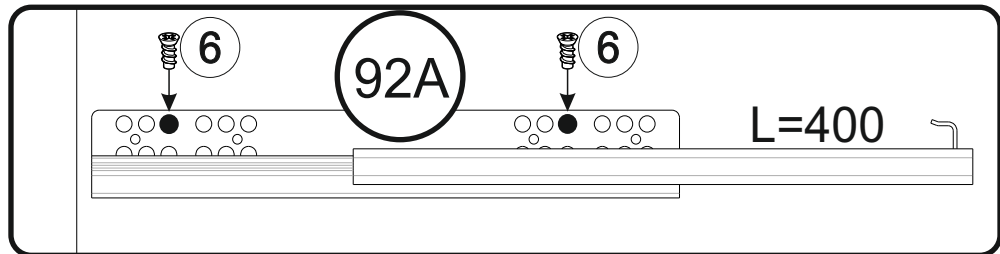
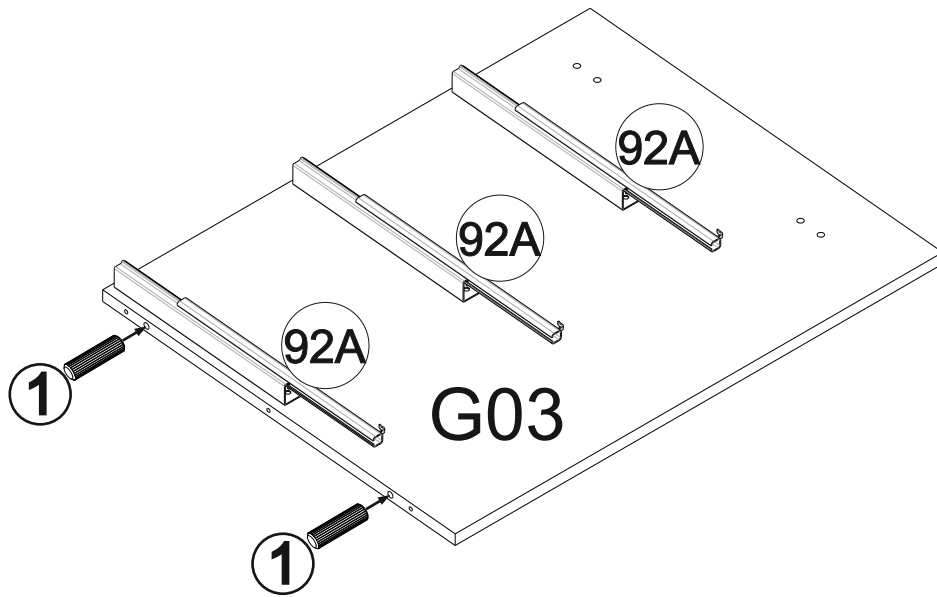
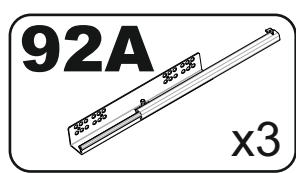
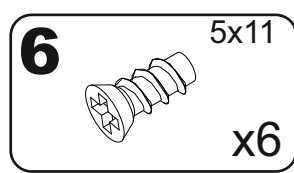
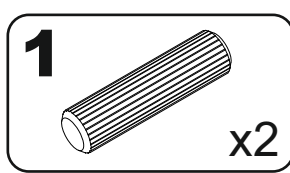

2

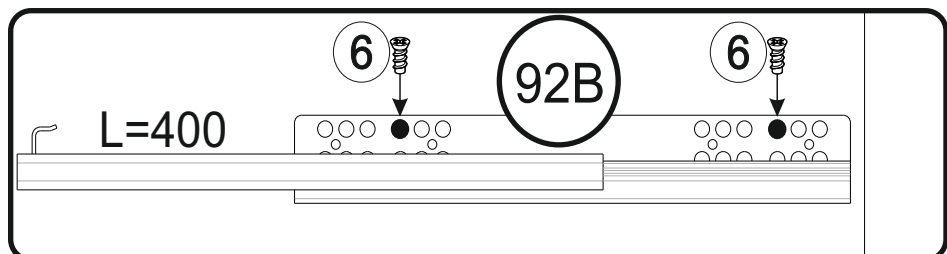
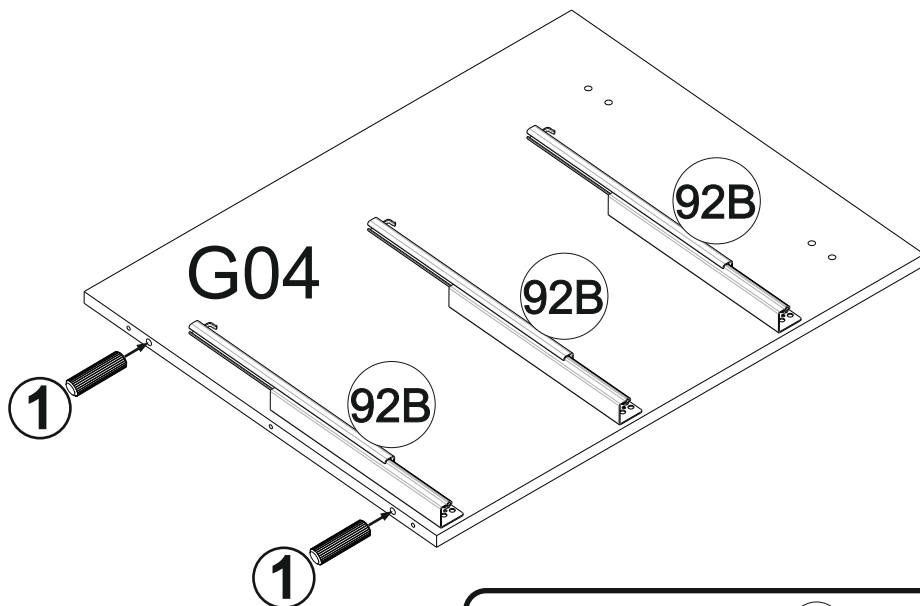
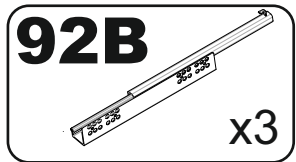
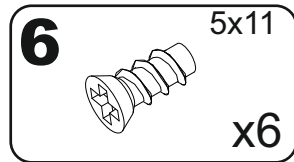
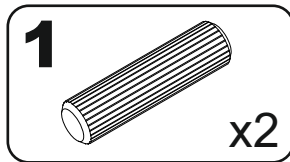

3

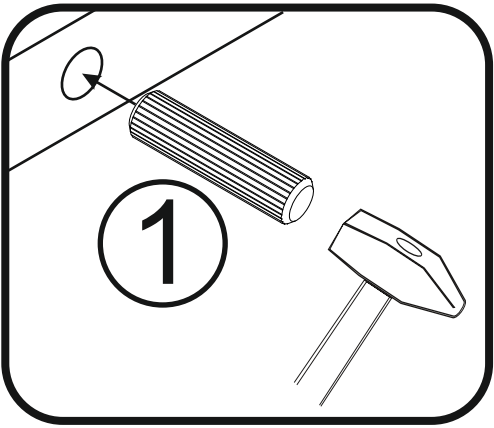
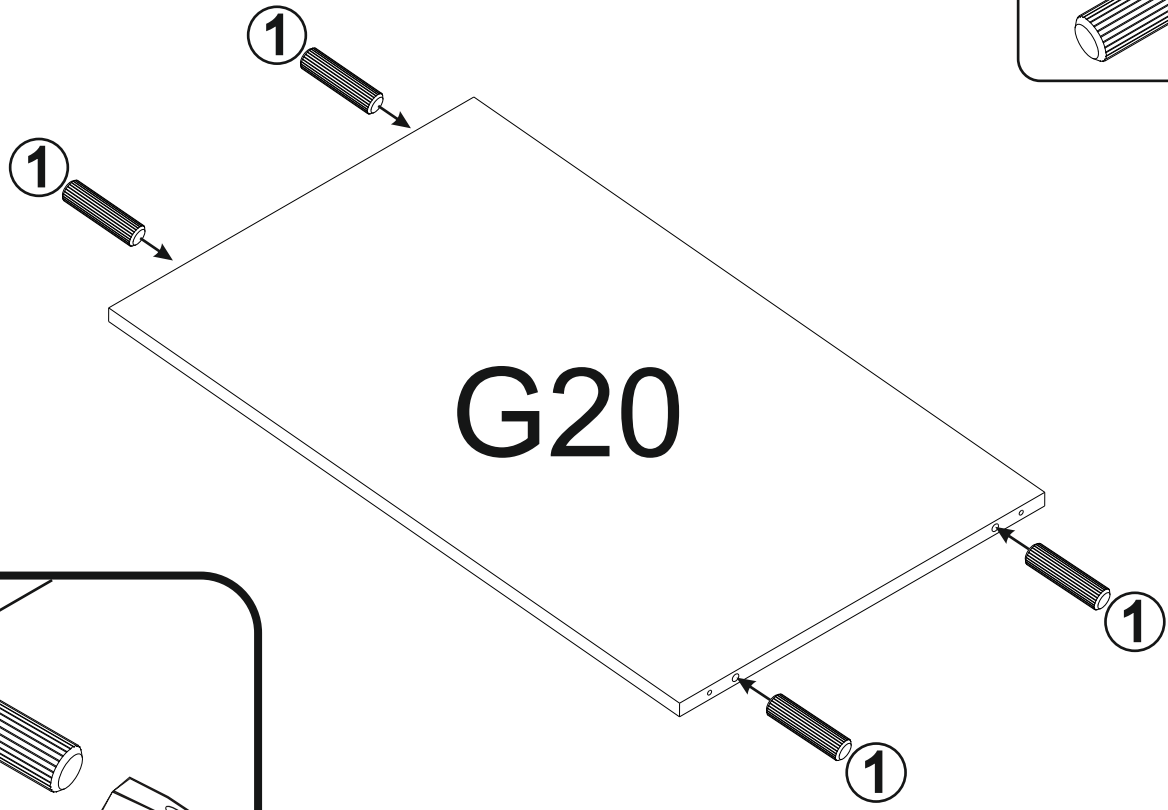
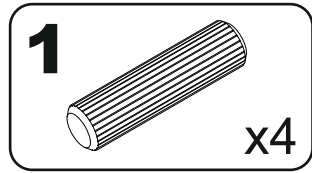

4

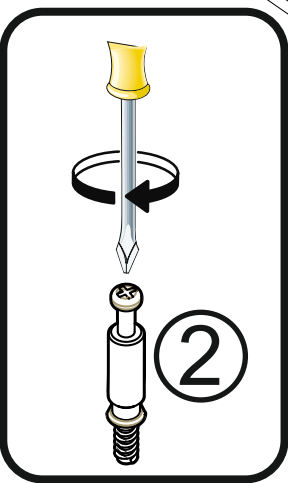
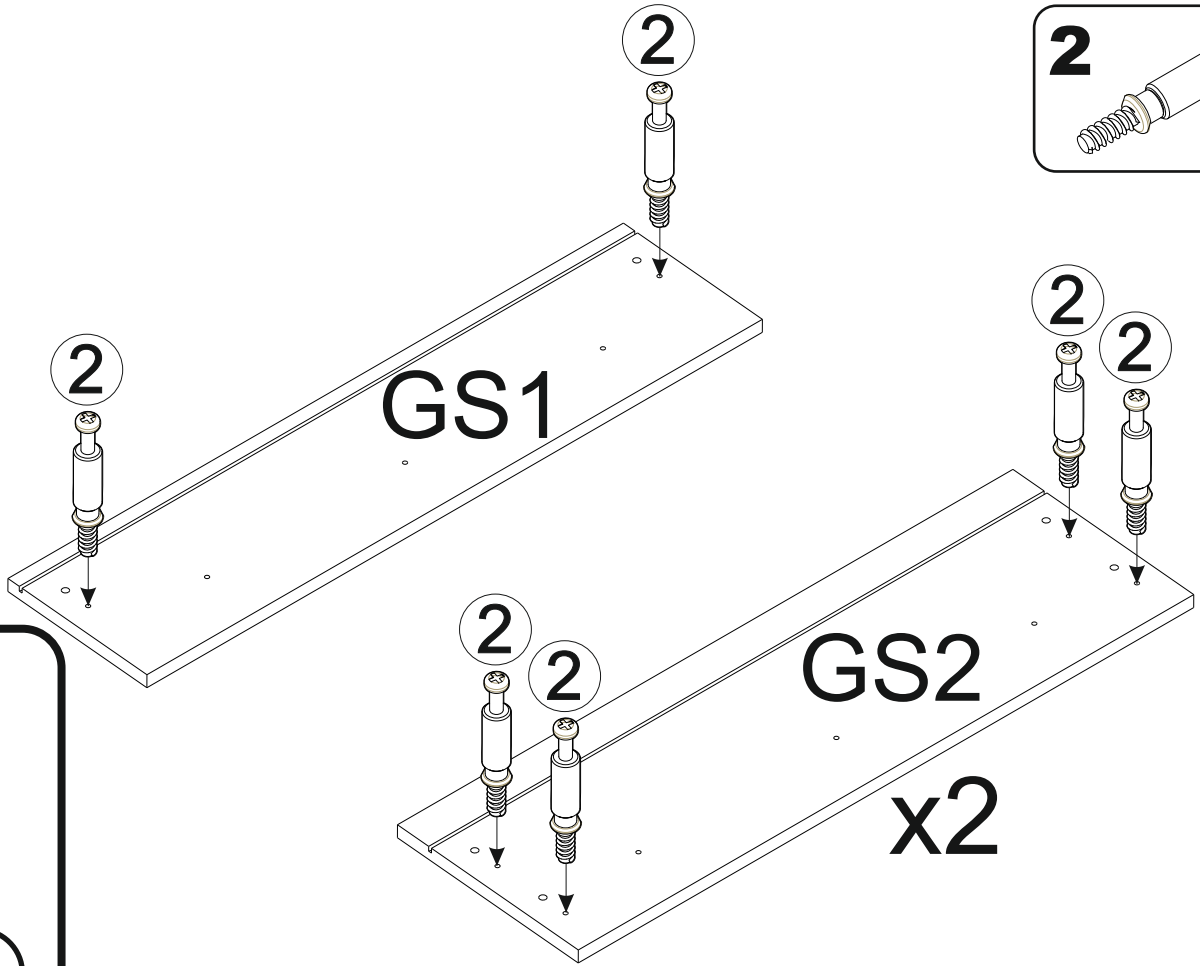
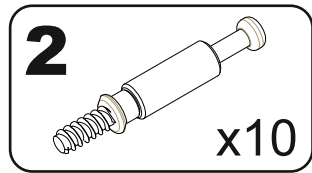

5

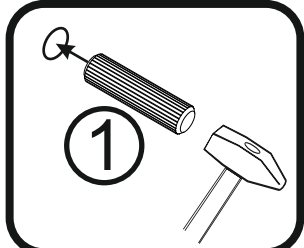
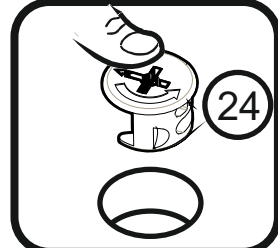
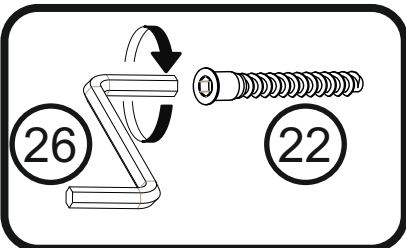
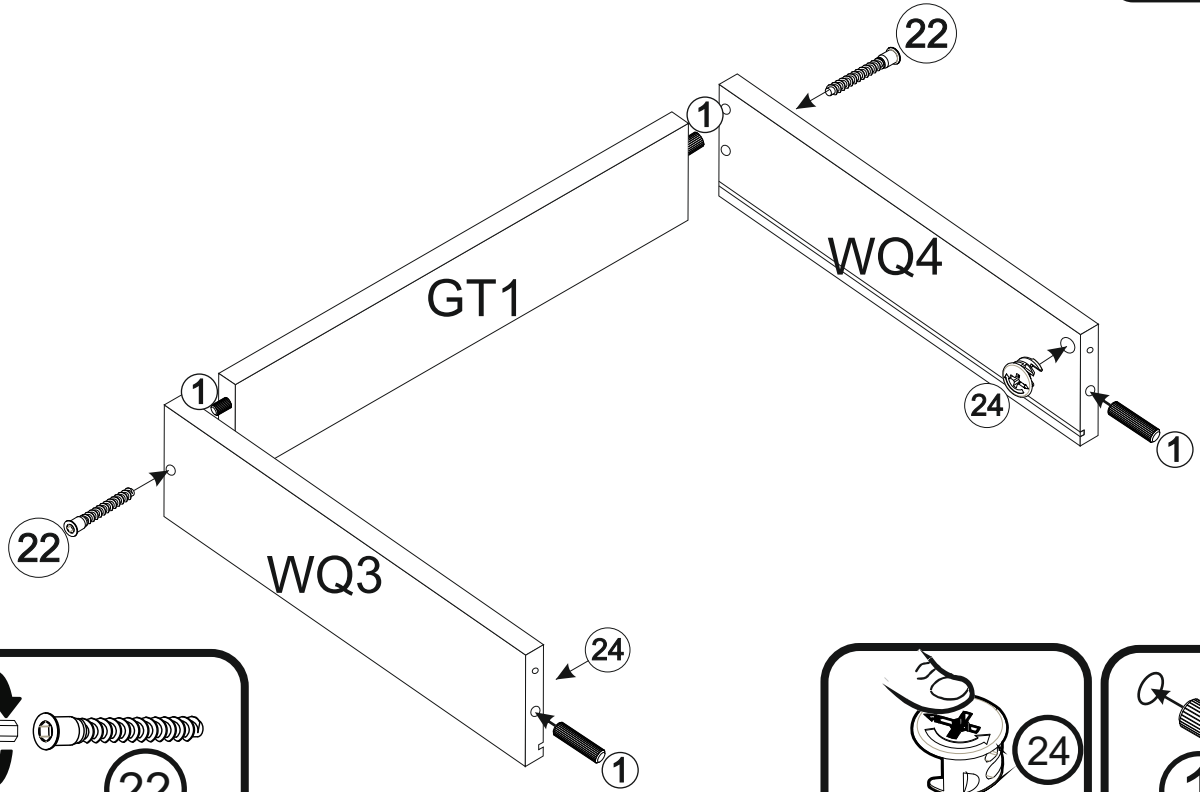
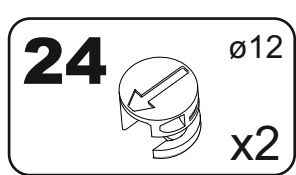
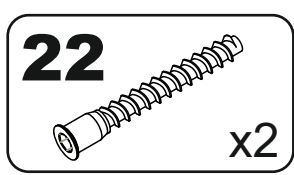
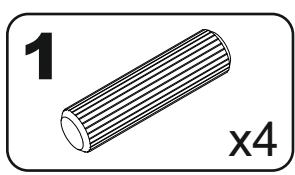

6

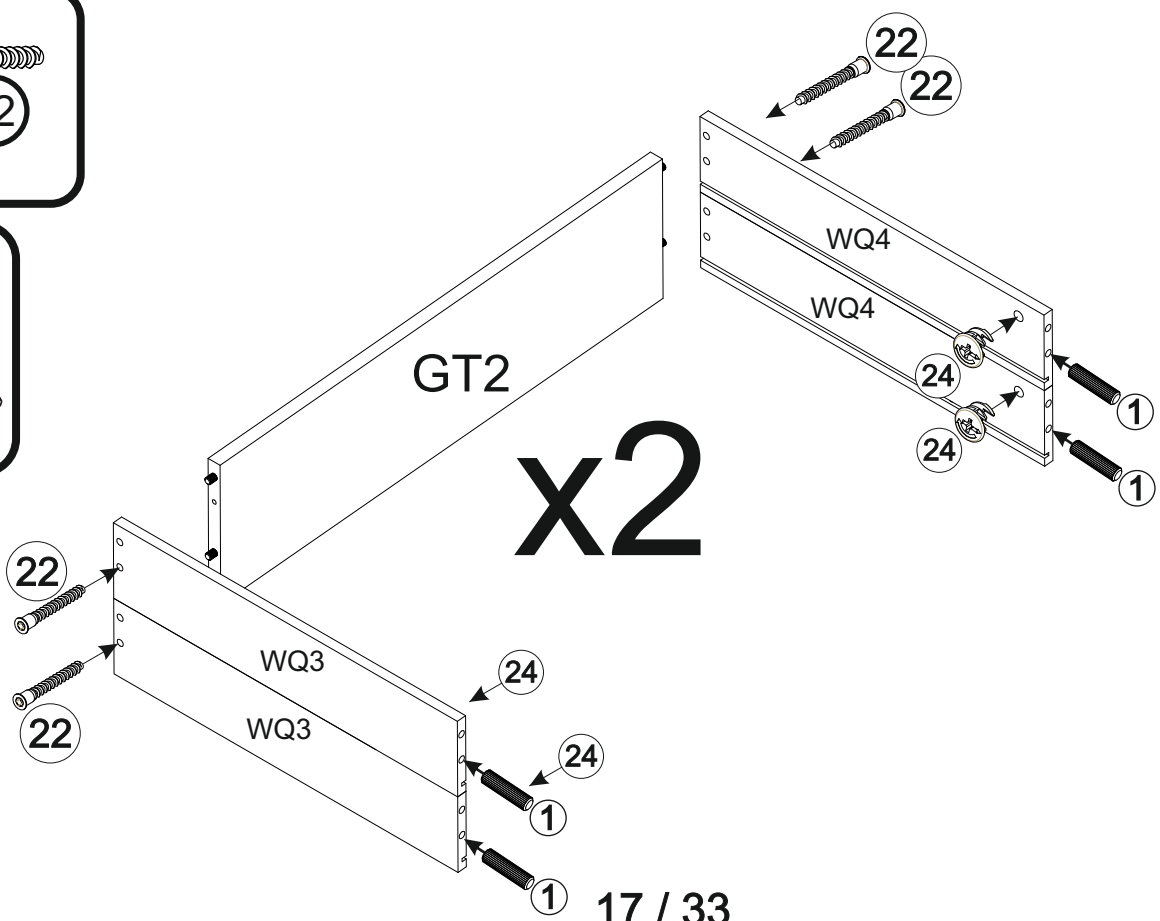
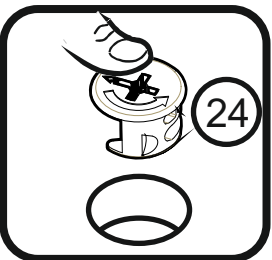
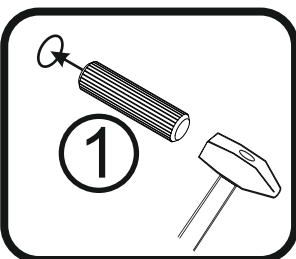
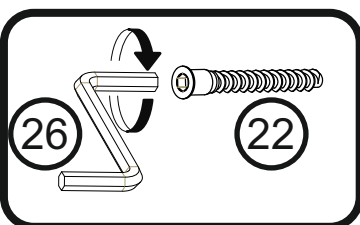
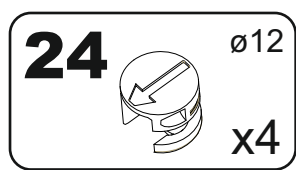
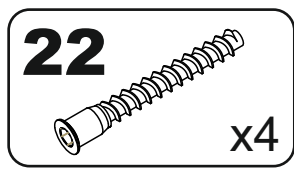
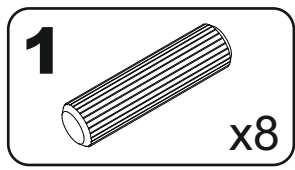

7

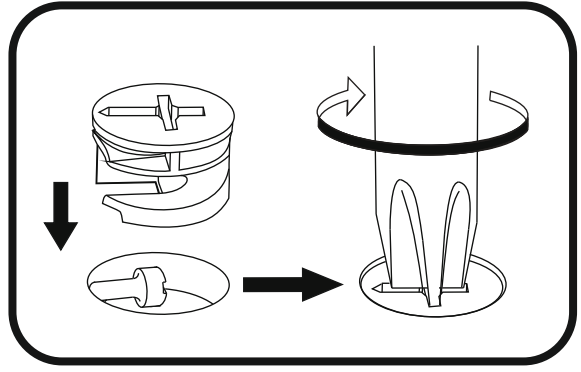
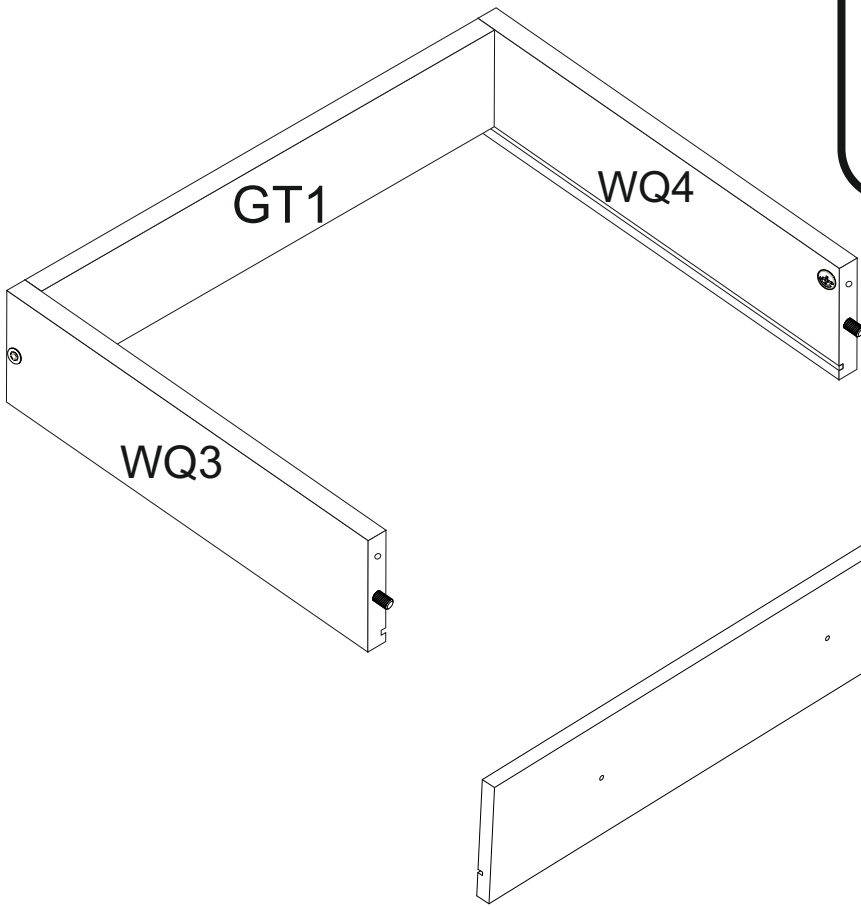

8

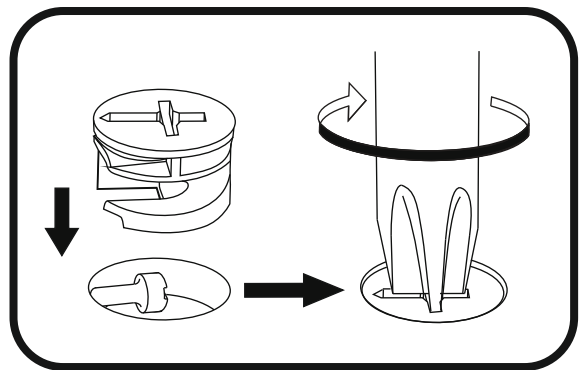
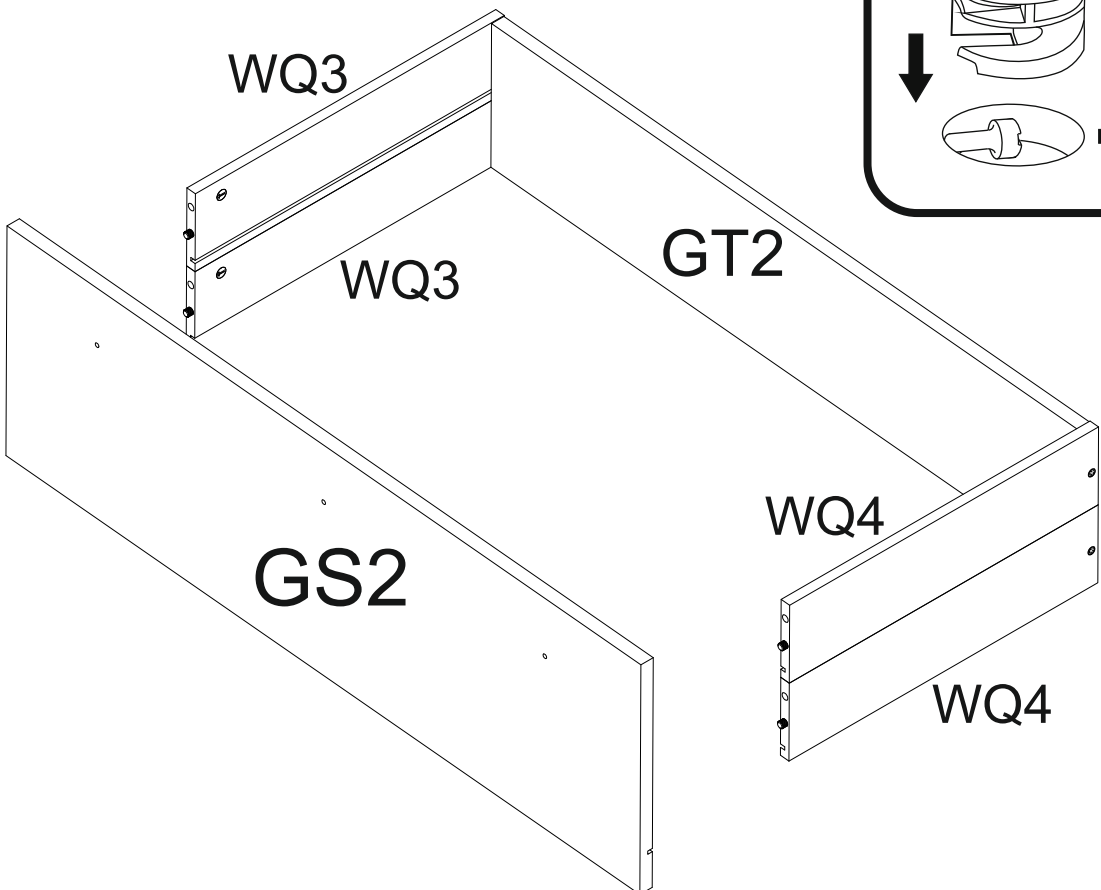

x2

9

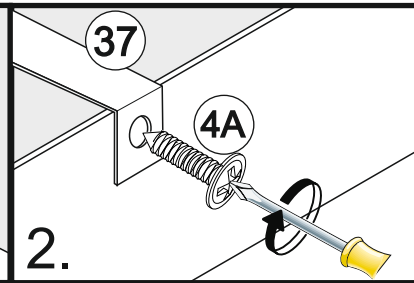
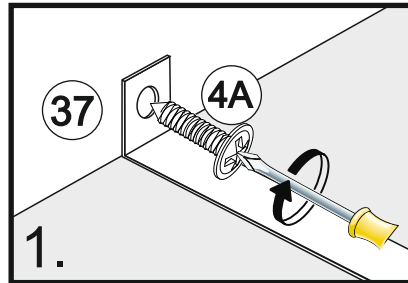
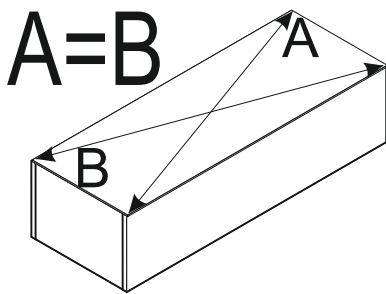
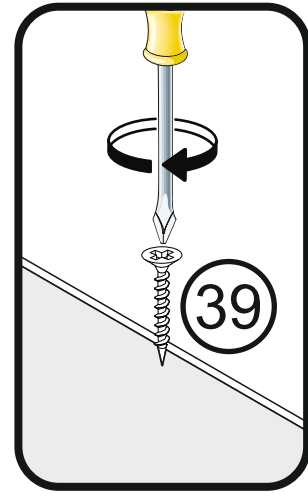
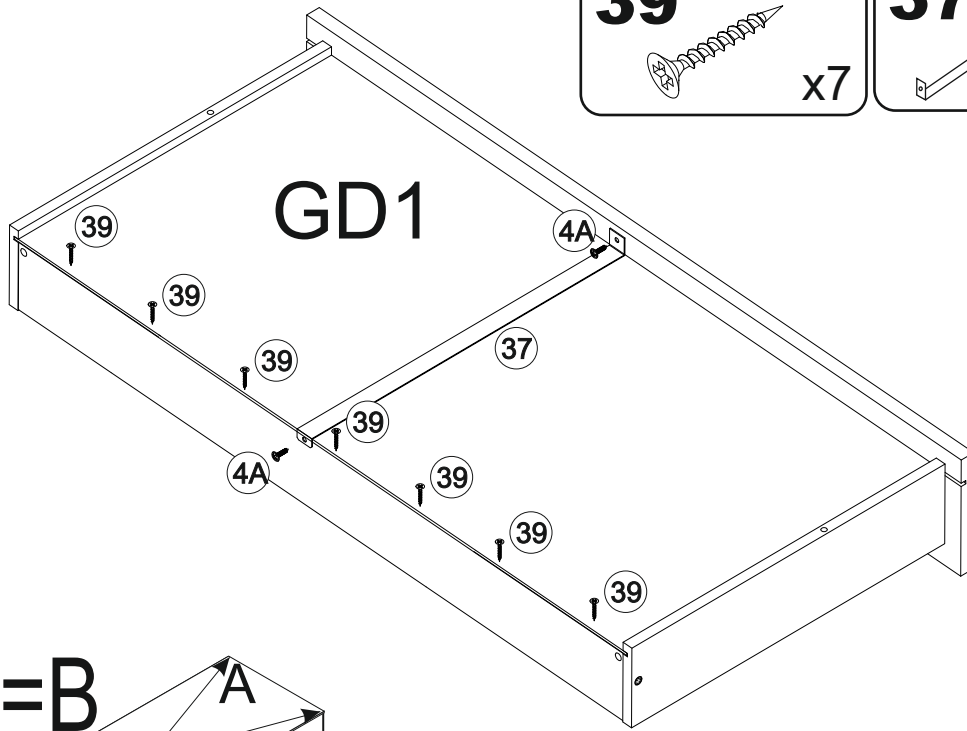
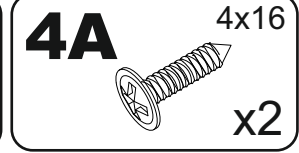
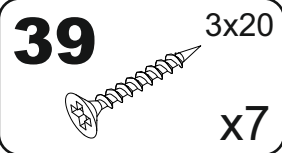

10

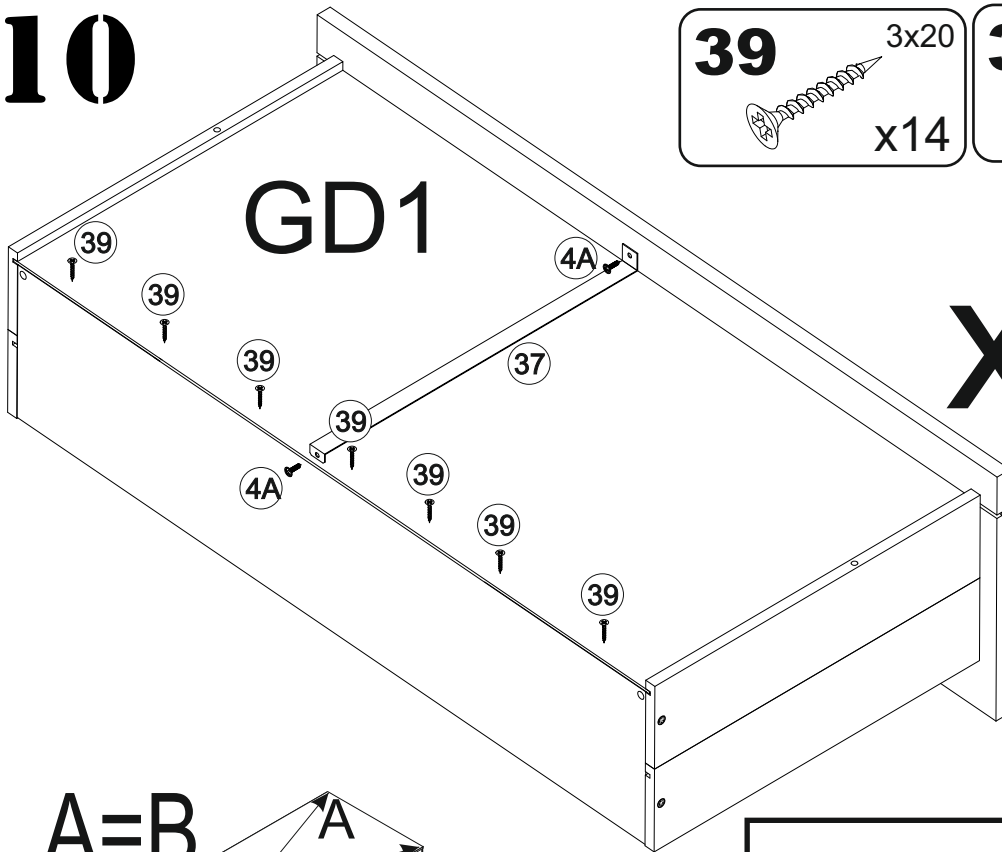
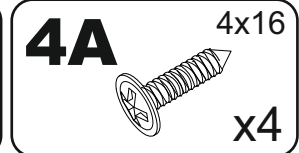
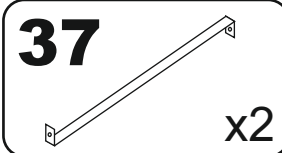
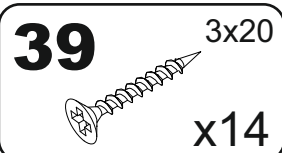

x2

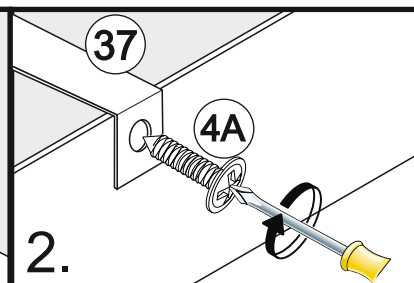
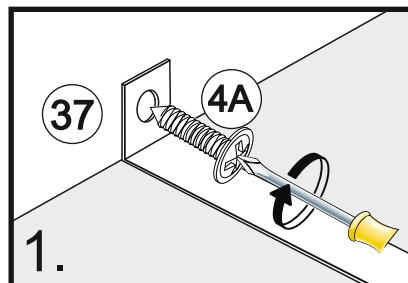
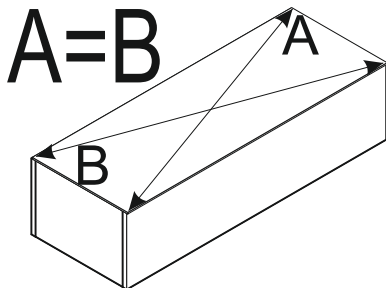
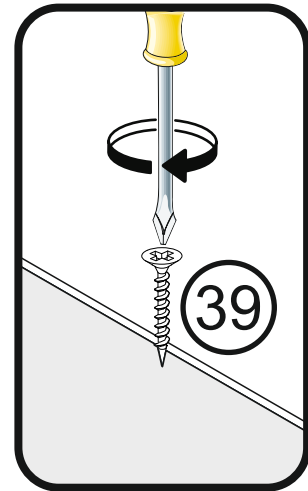

11

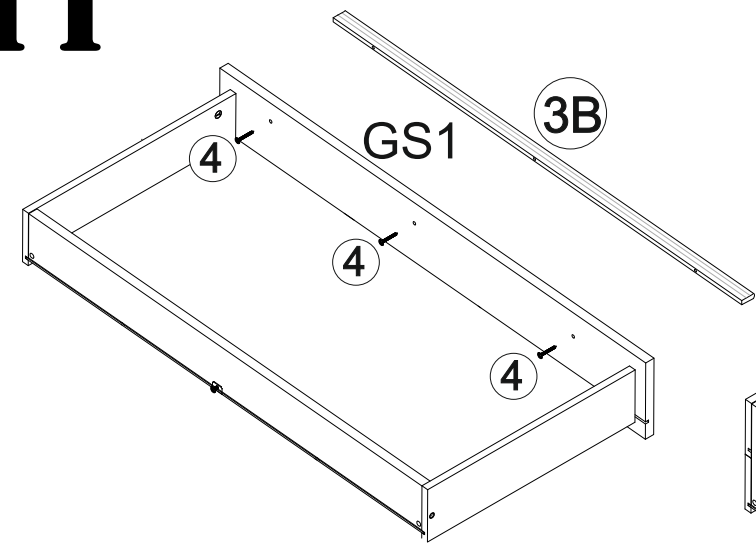

3B
720mm x3

4 3.5x30
x9

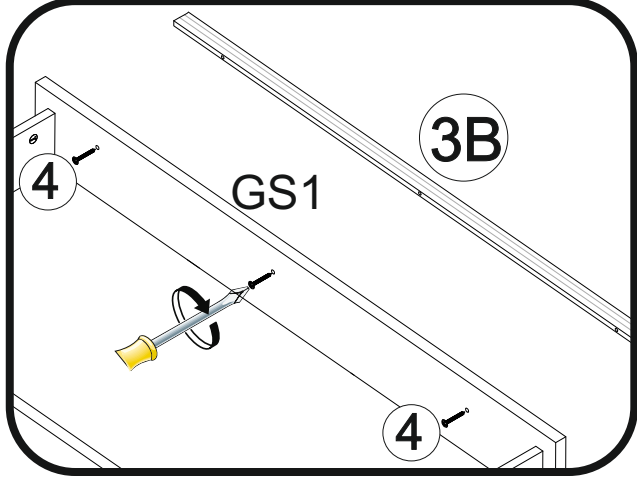
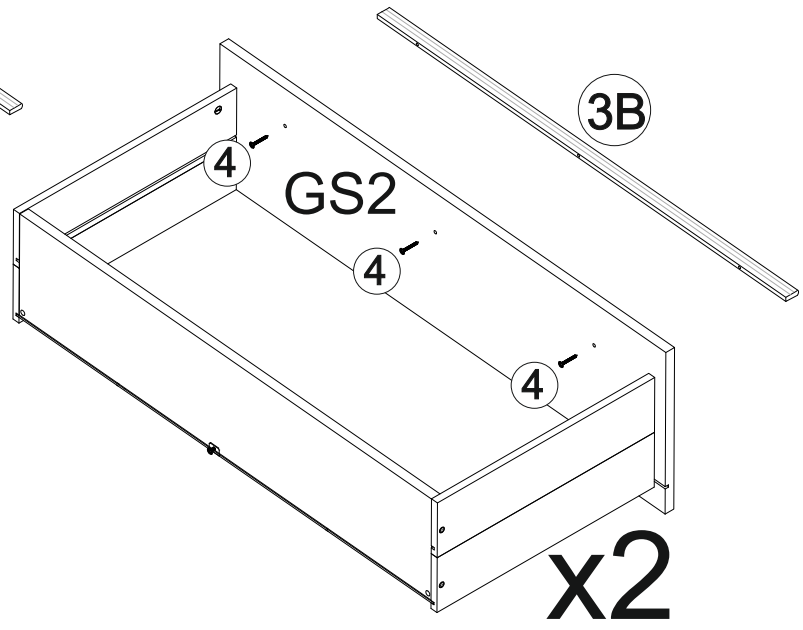

12

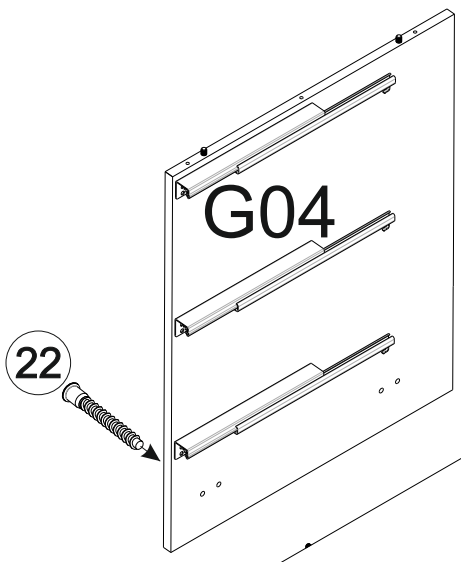

22
x4

22A
x4

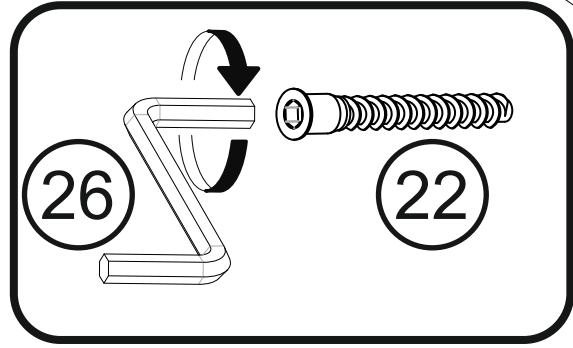
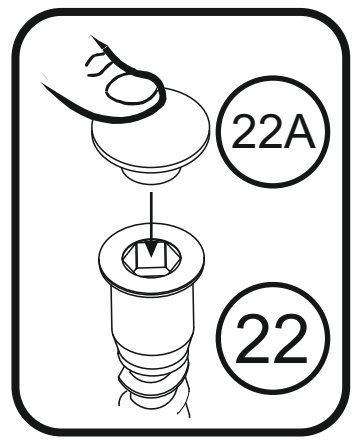
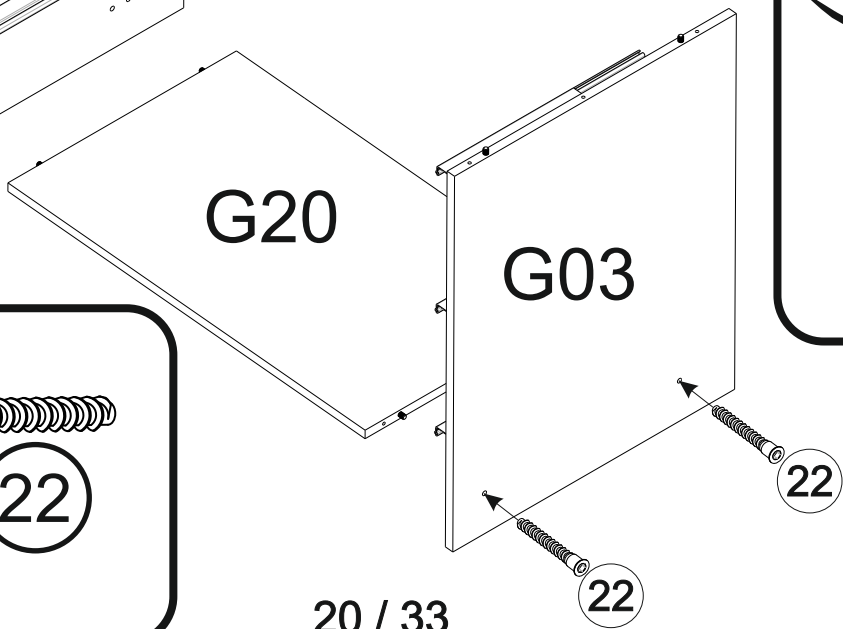

13

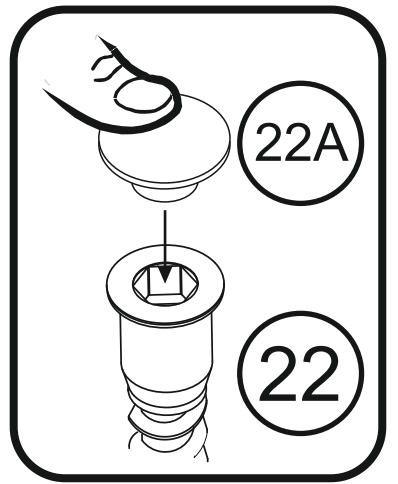
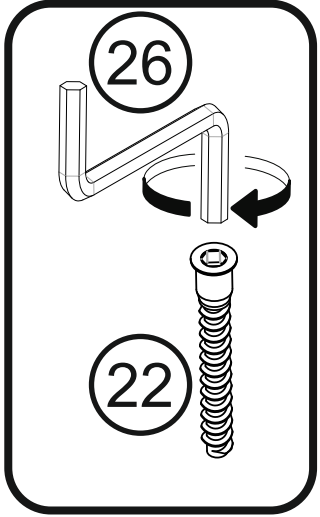
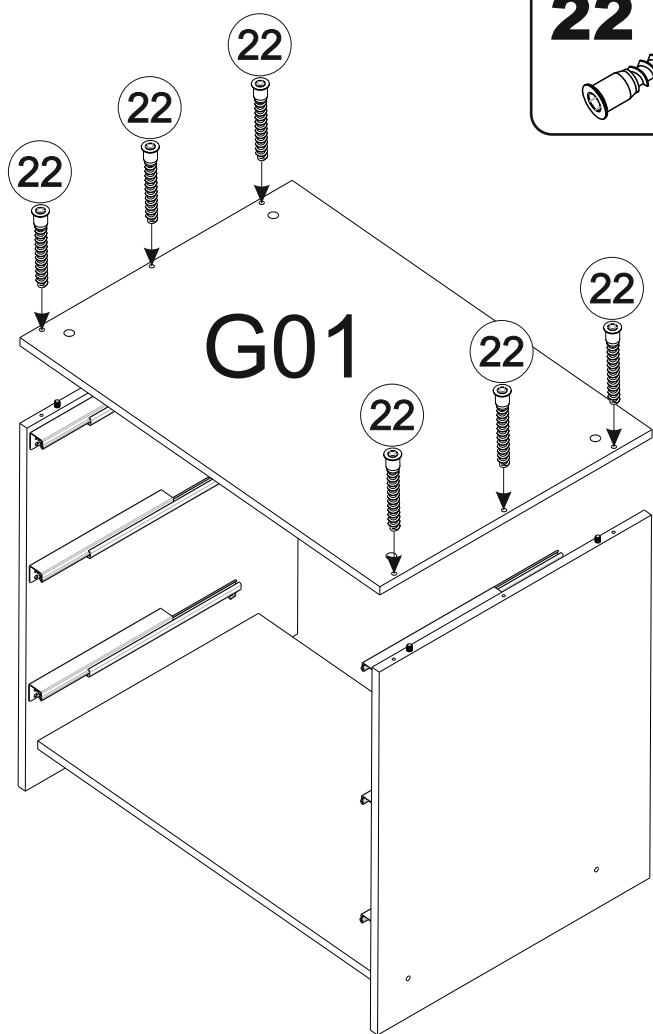
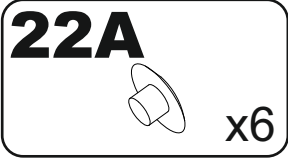
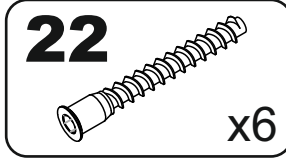

14

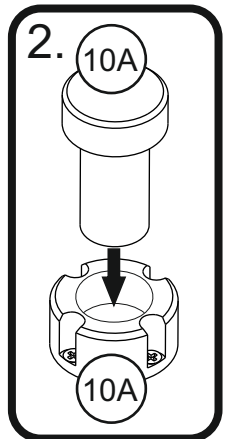
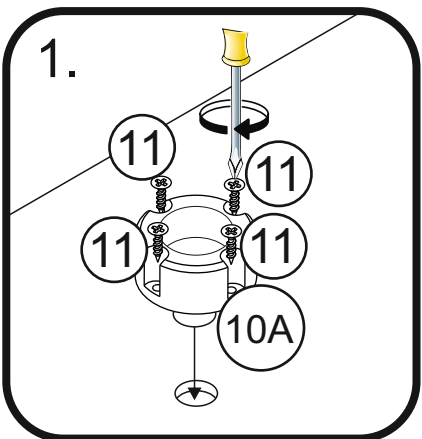
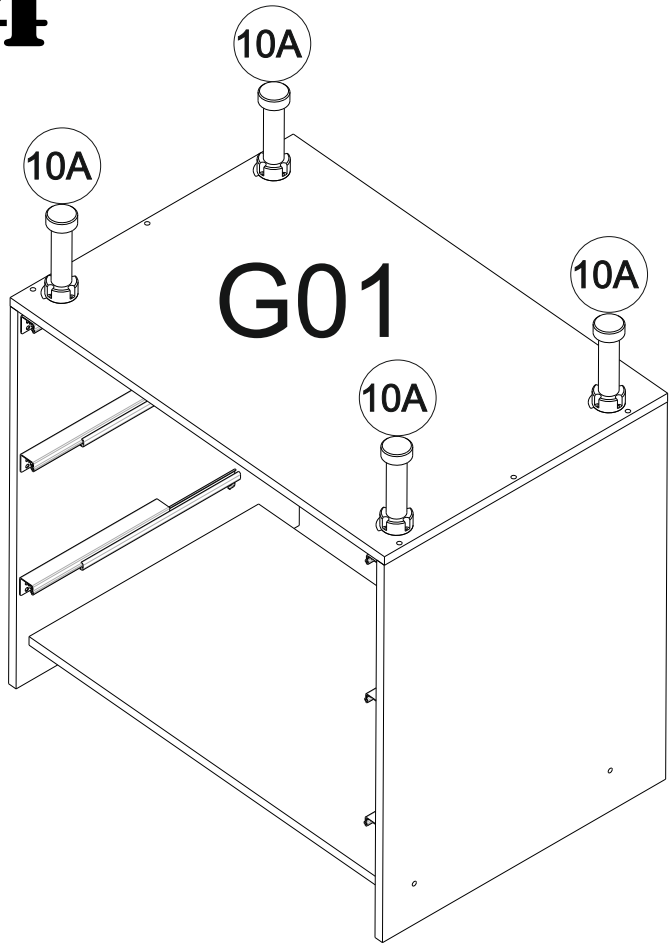
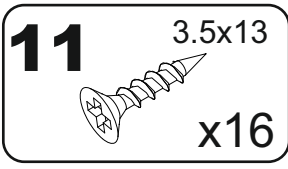
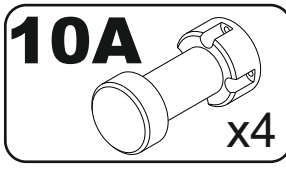

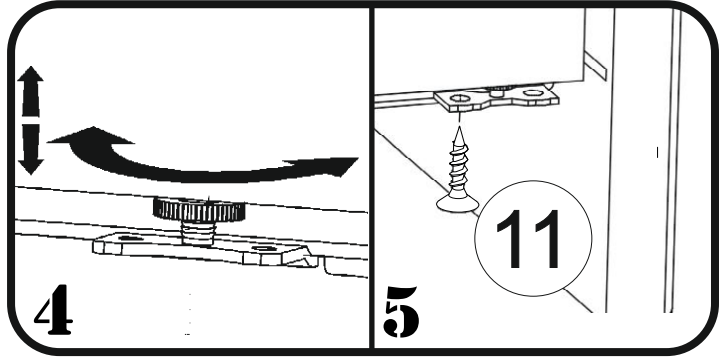
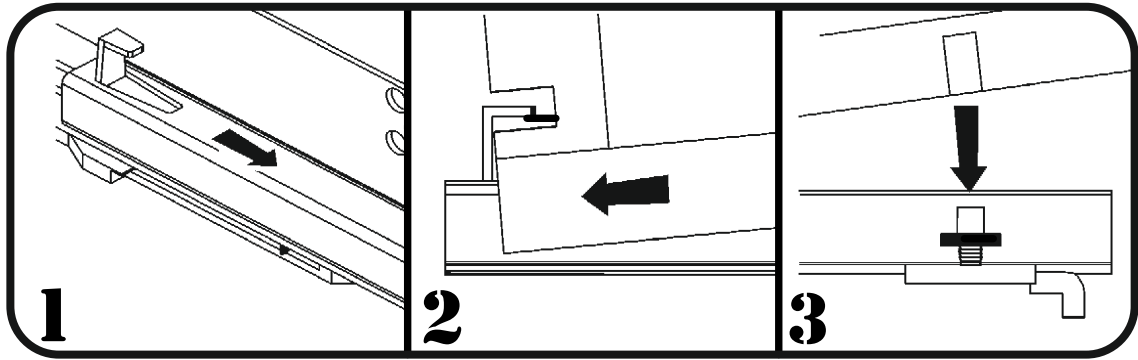
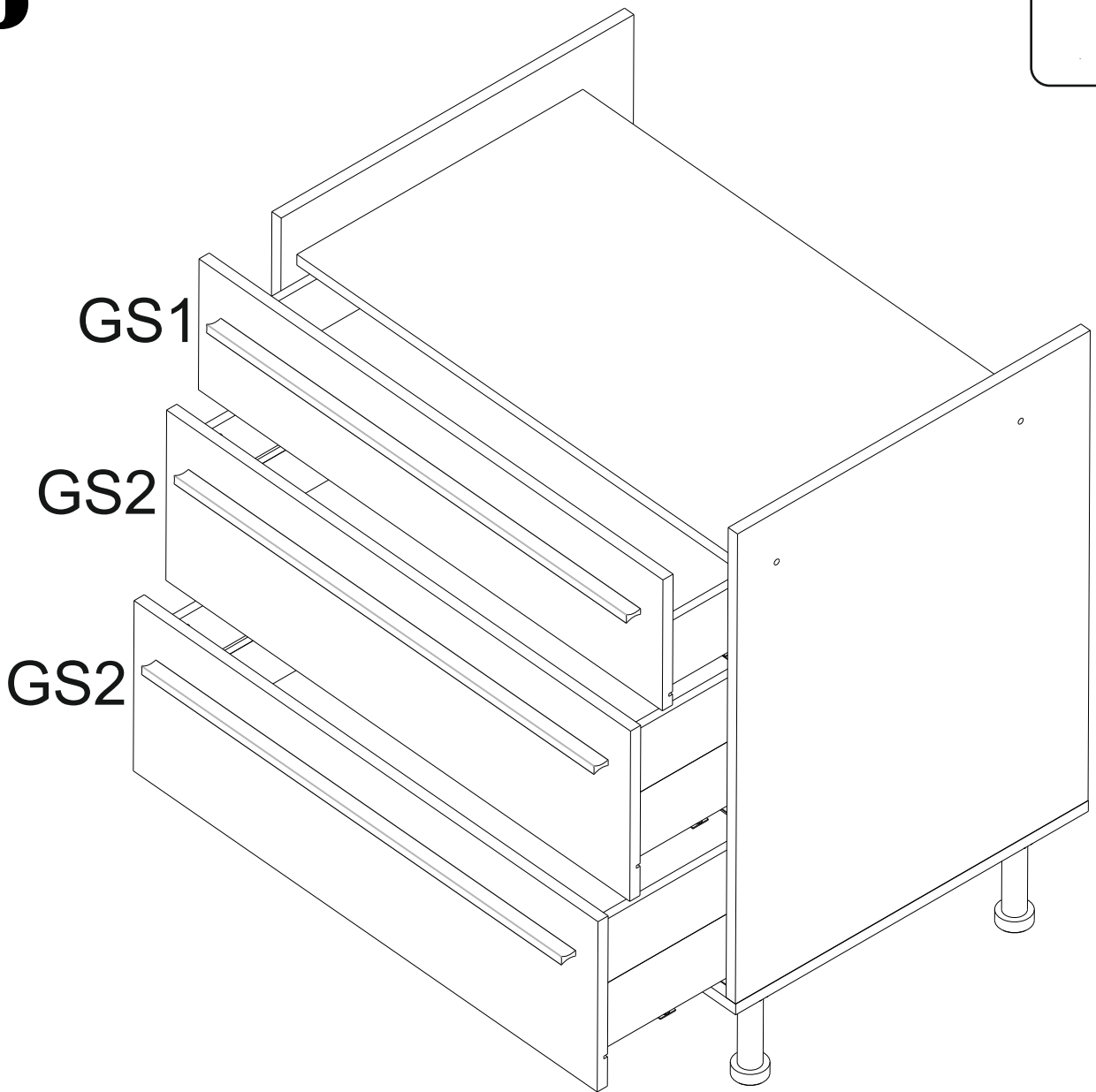

K

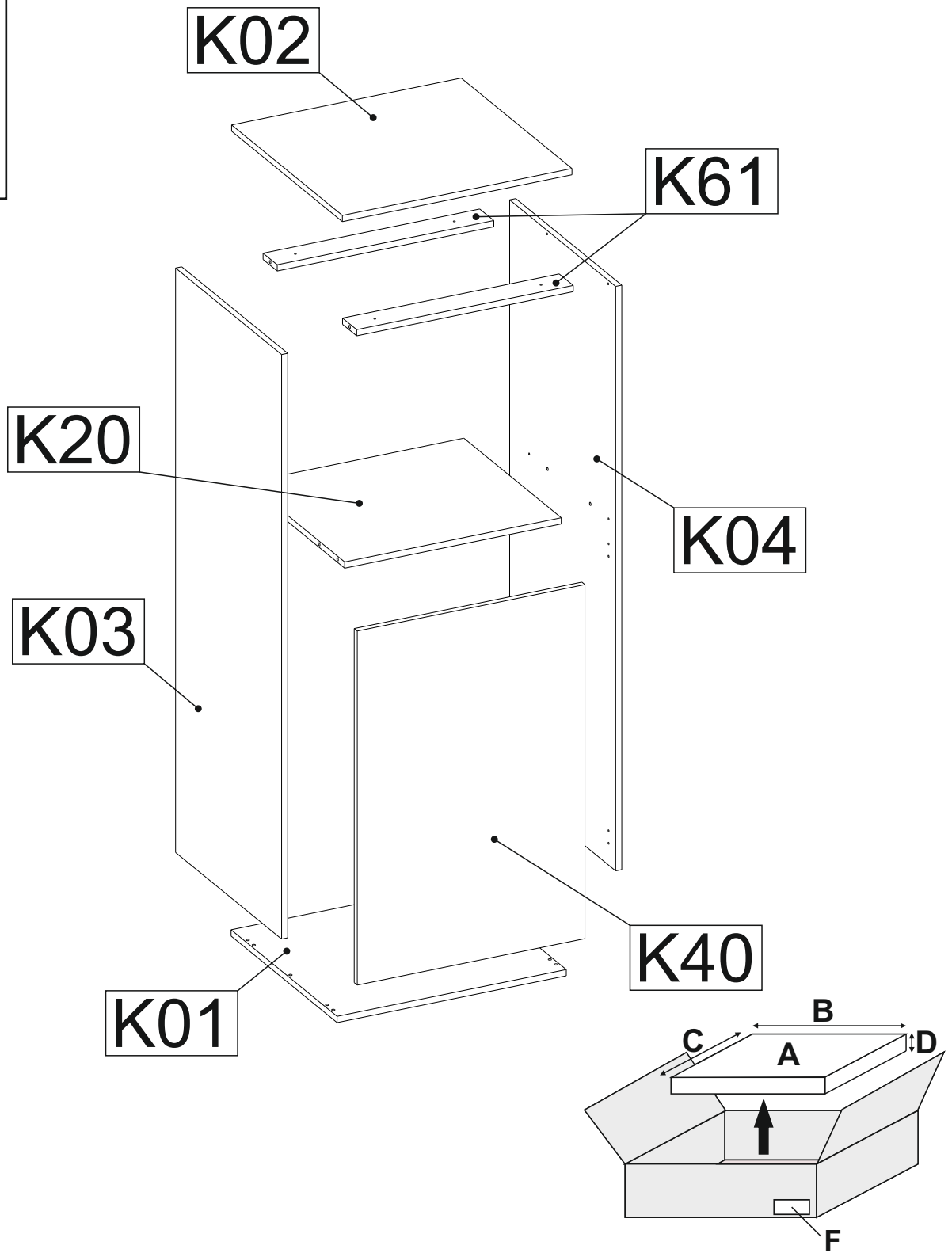

A	B (mm)	C (mm)	D (mm)	E	F
K01	600	555	16	1	5 7
K02	601	580	16	1	6 7
K03	1499	555	16	1	5 7
K04	1499	555	16	1	5 7
K20	567	510	16	1	6 7
K40	908	596	16	1	6 7
K61	567	74	16	2	6 7

1

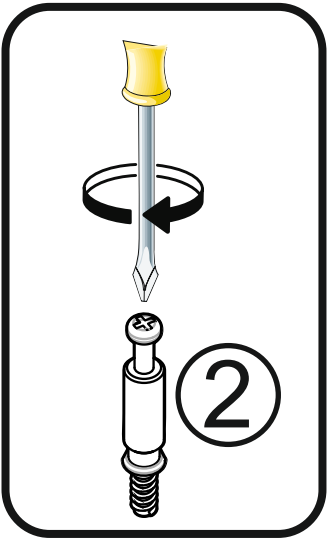
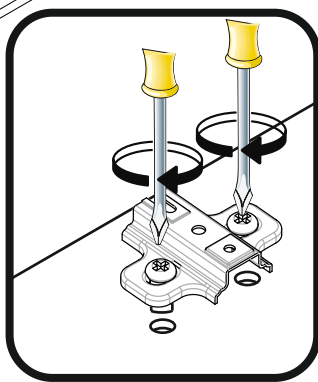
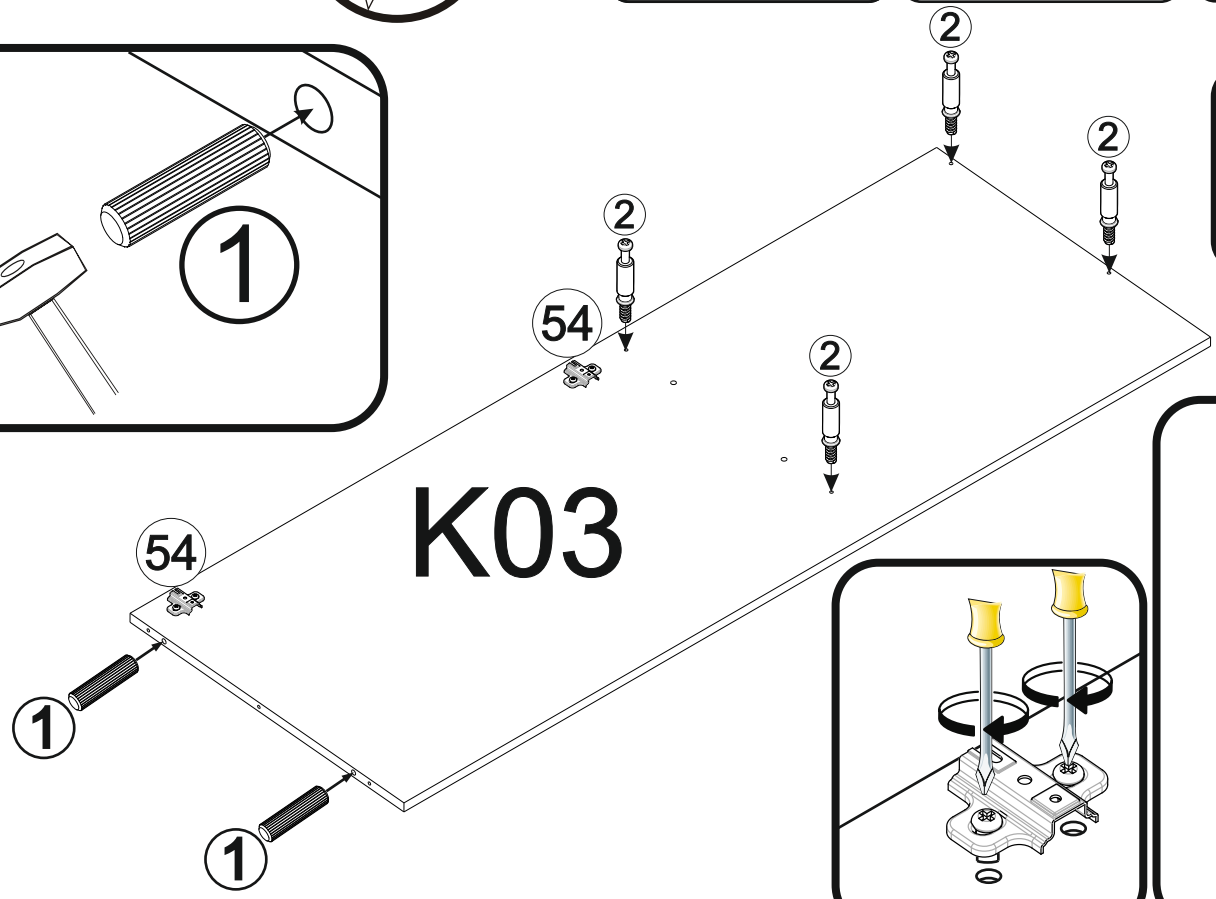
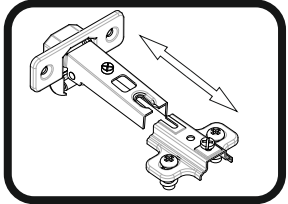
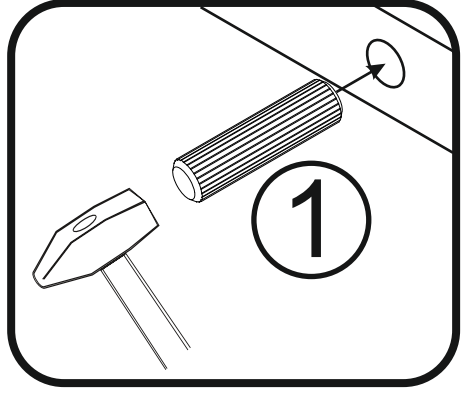
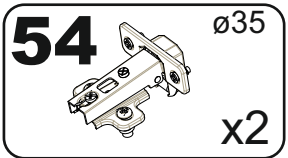
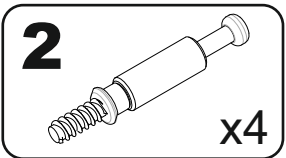
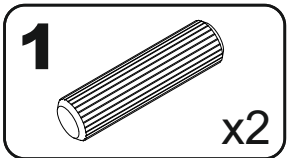
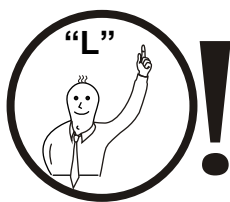

2

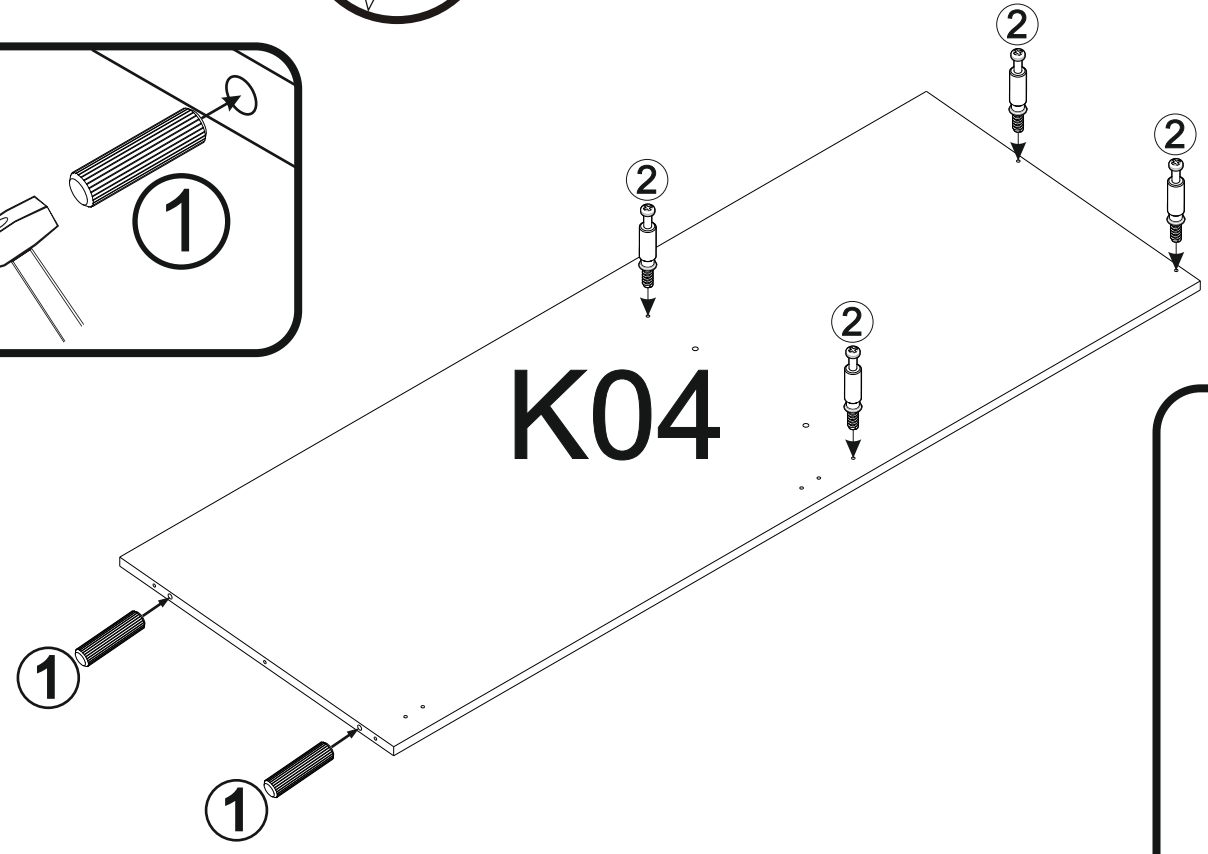
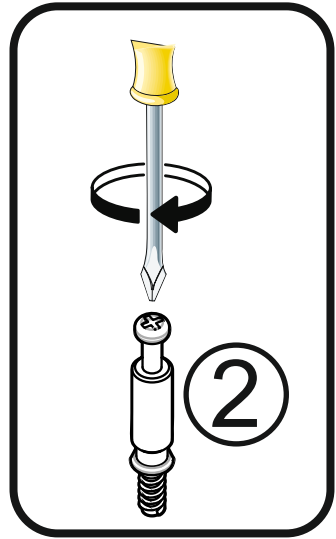
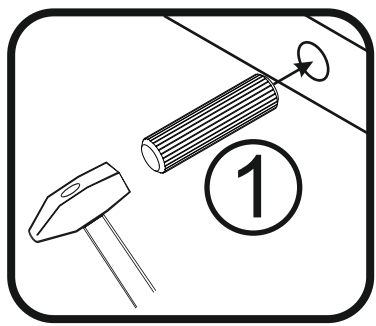
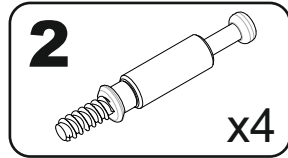
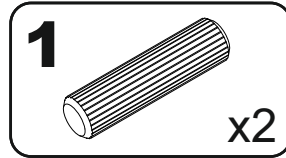
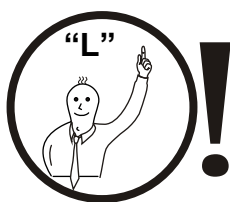

3

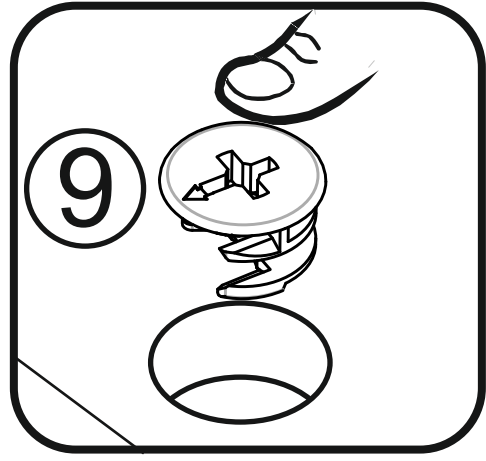
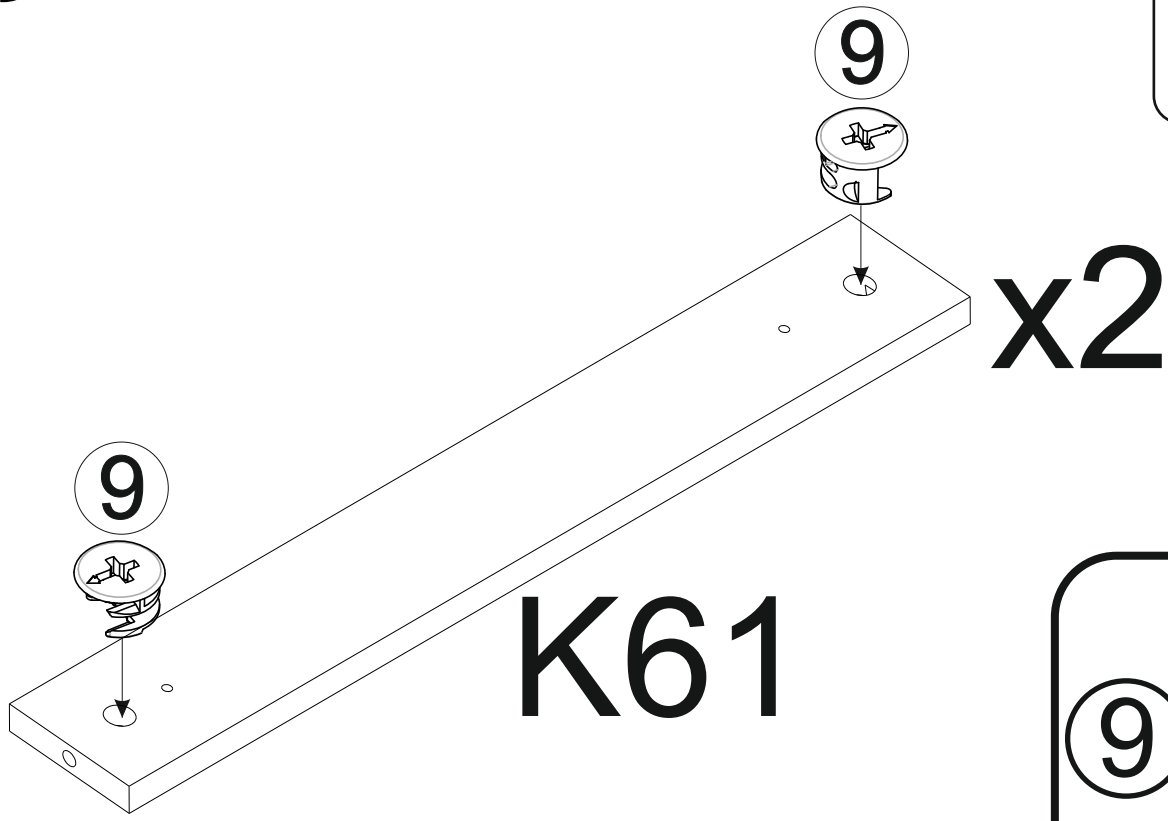
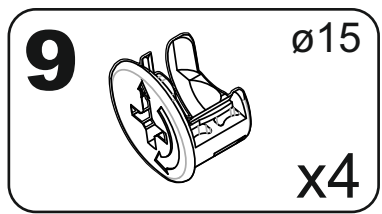

4

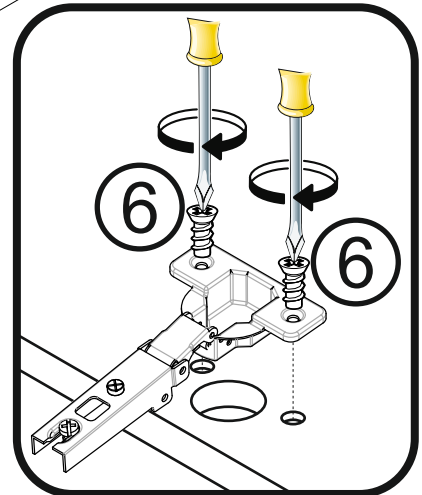
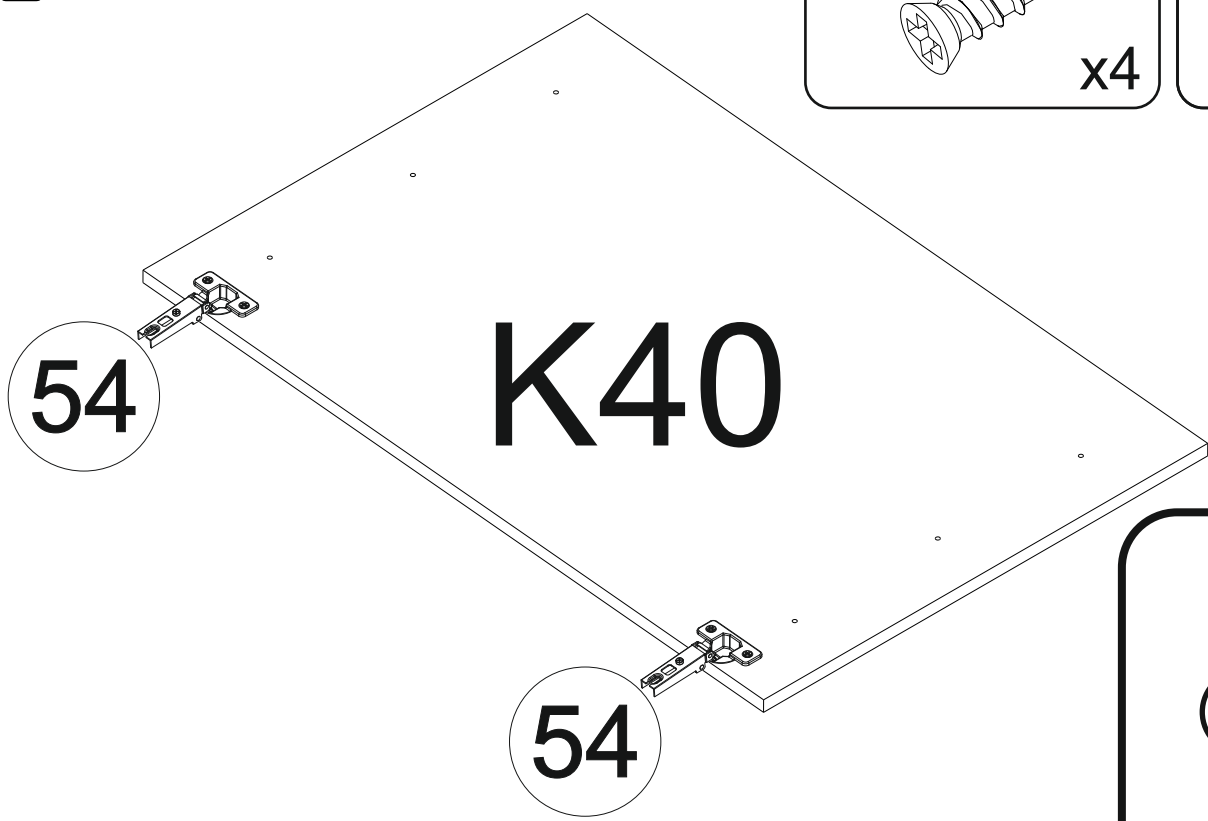
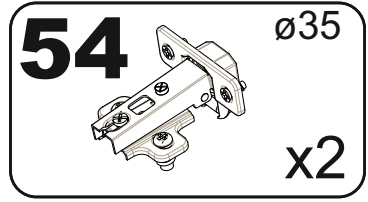
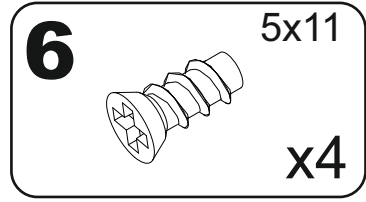

5

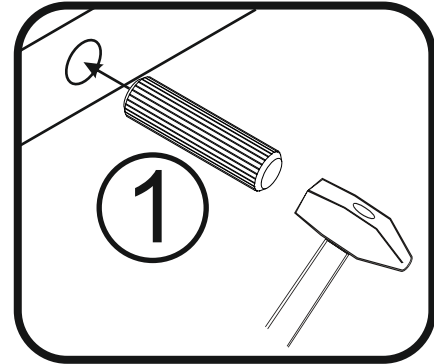
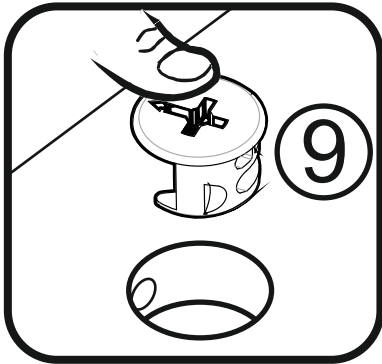
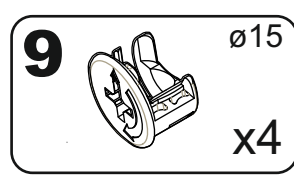
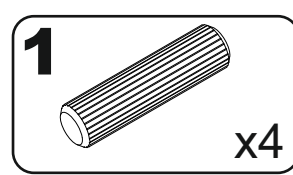
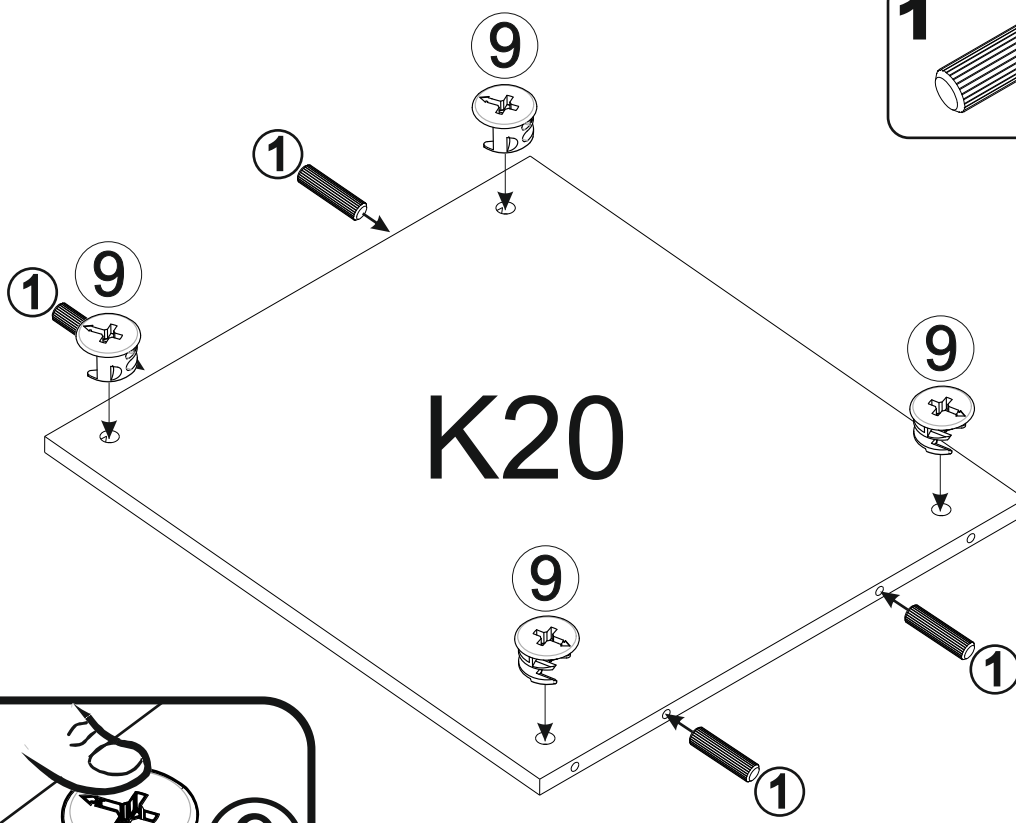

6

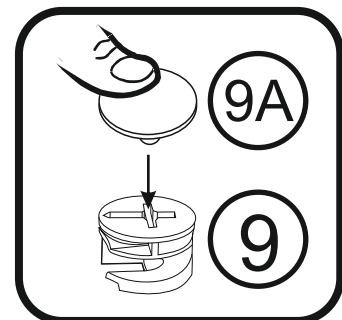
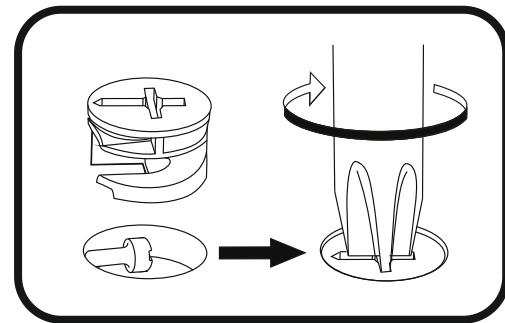
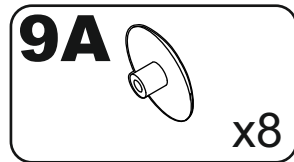
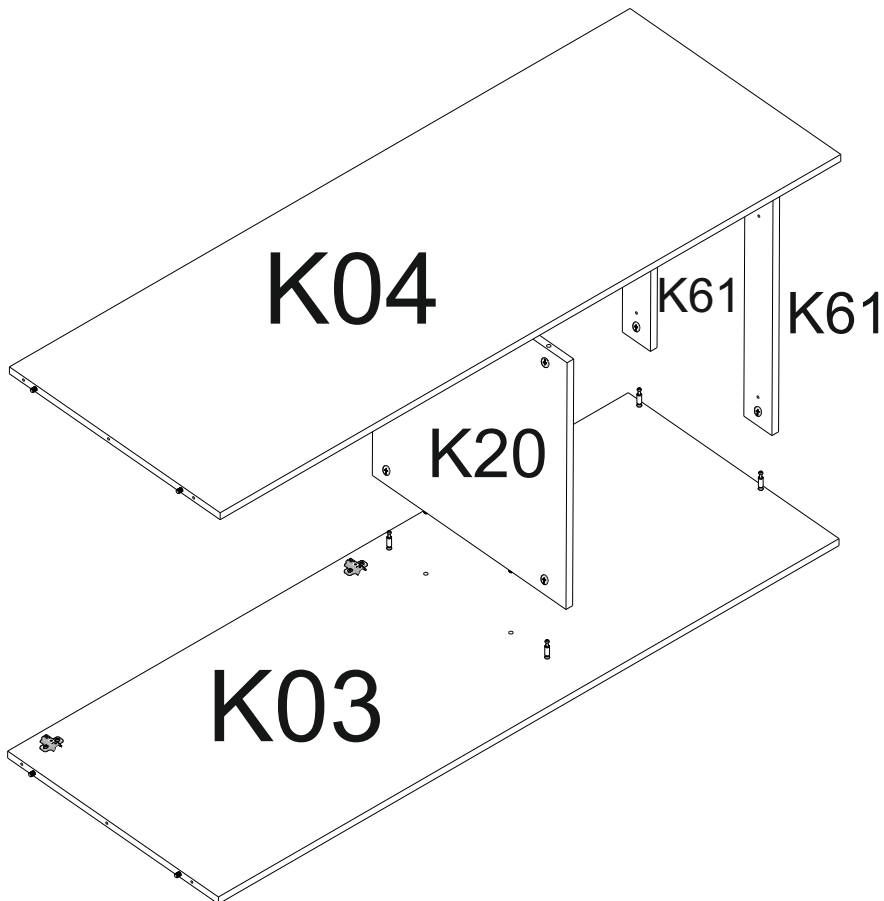

7

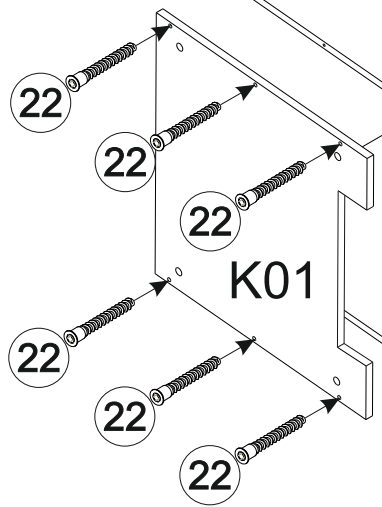
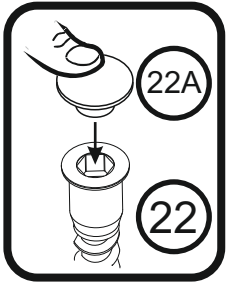
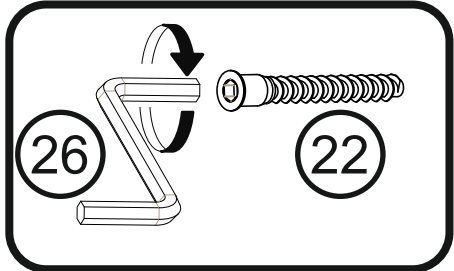
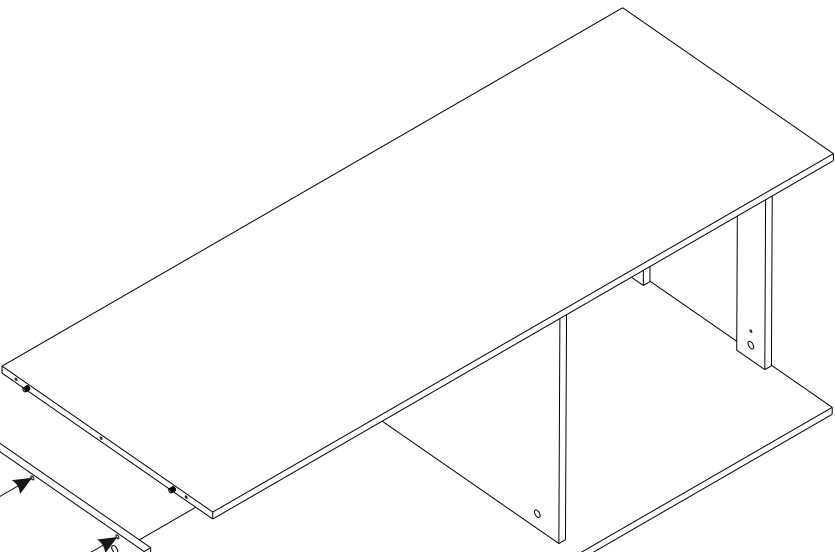
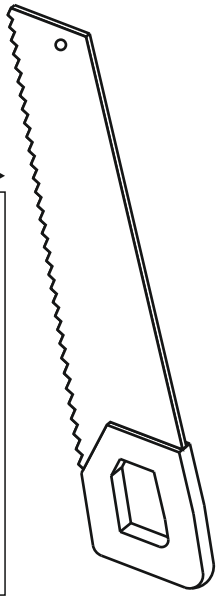
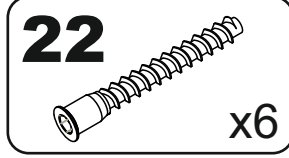
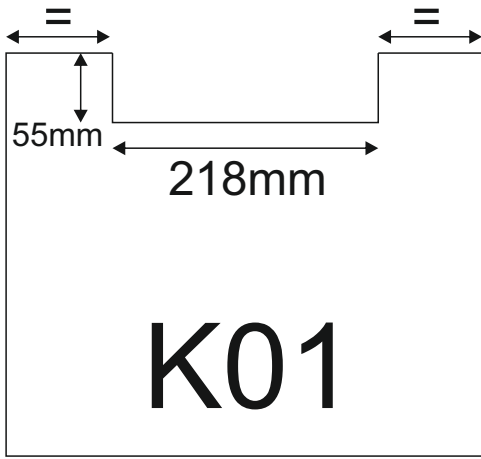

8

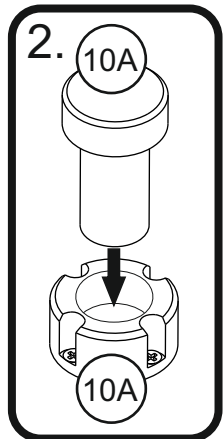
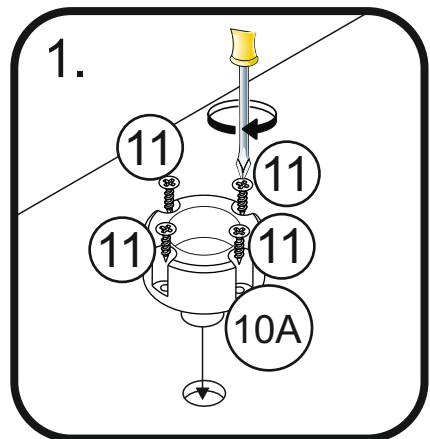
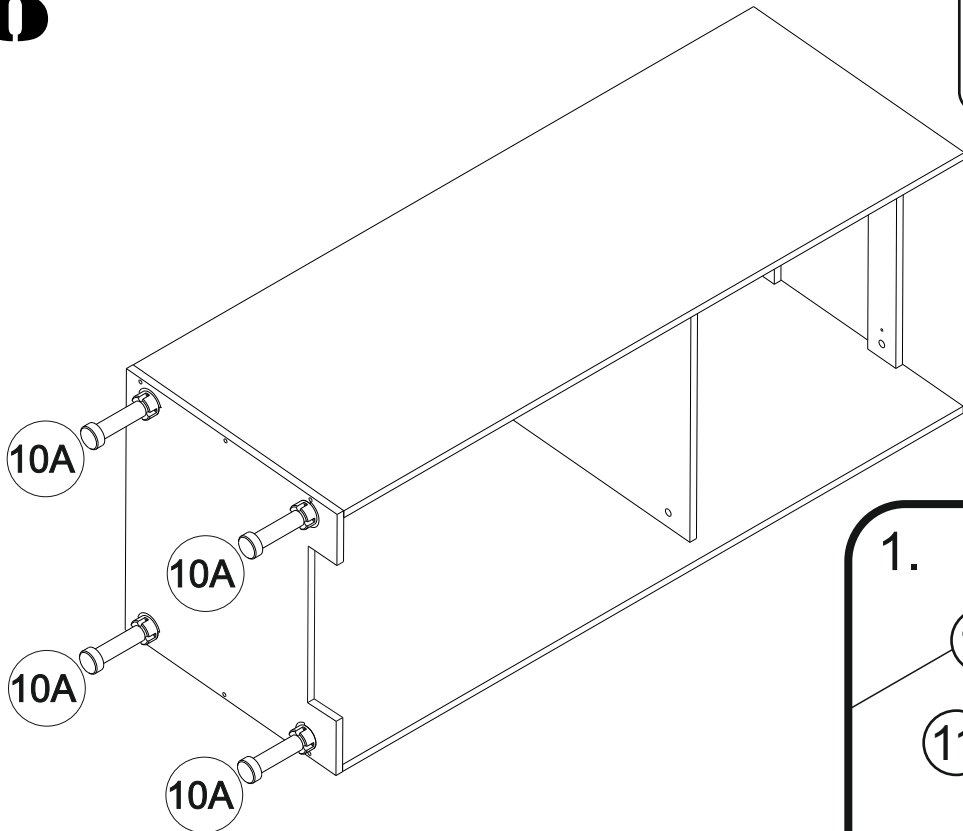
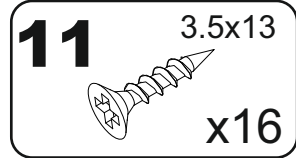
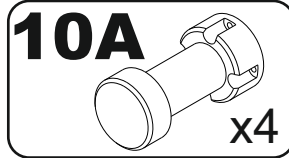

9

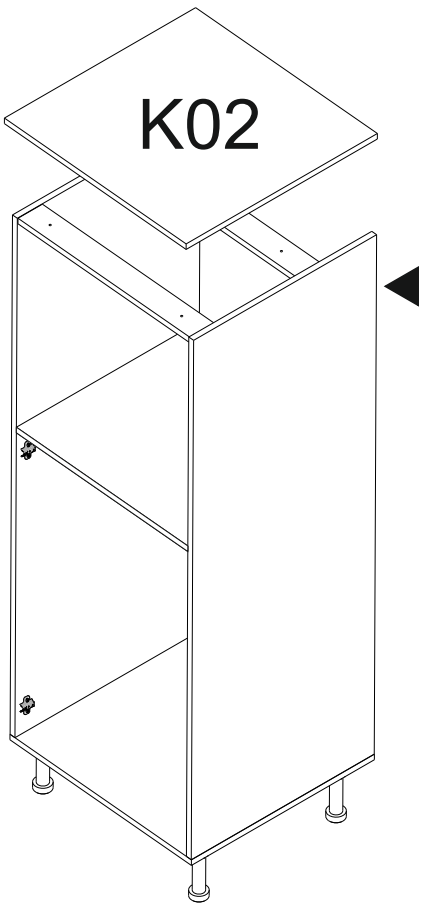

21 4x30
x4

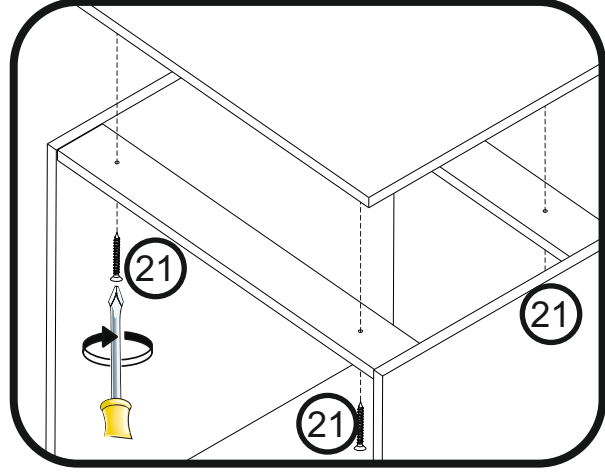
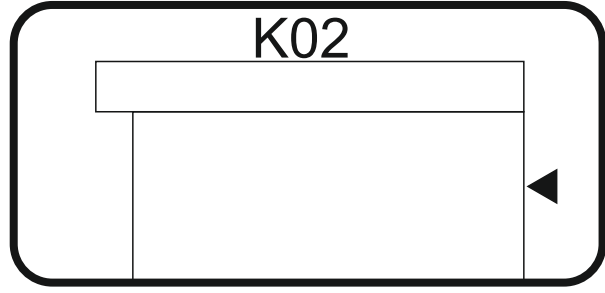

10

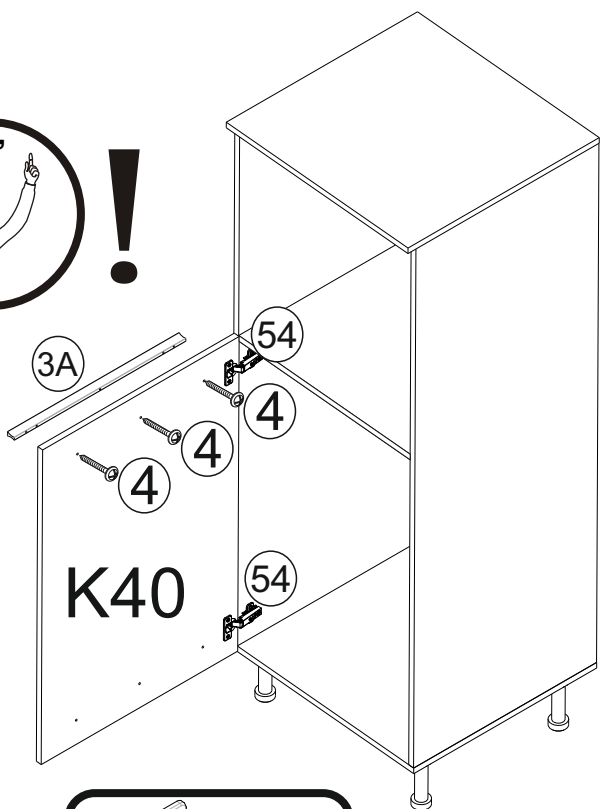
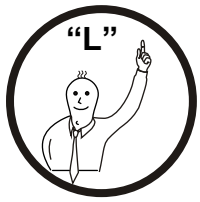

3A 520mm x1

4 3.5x30
x3

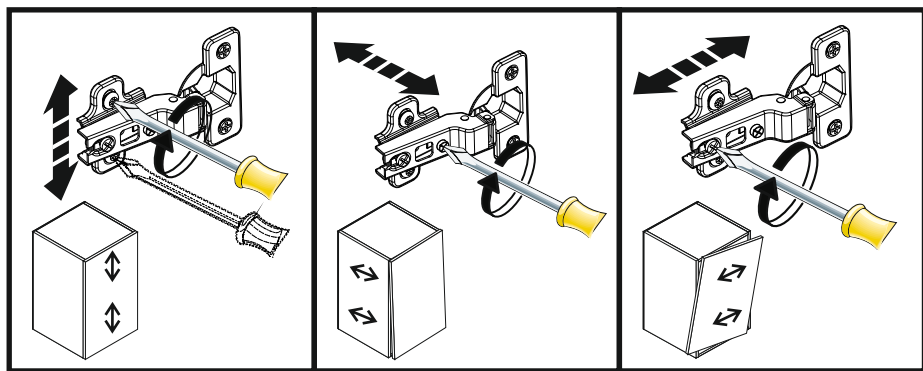
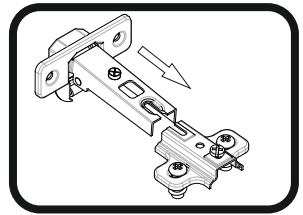
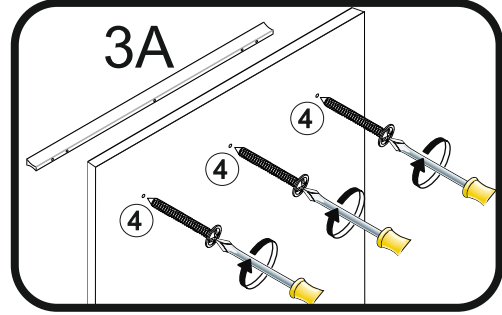
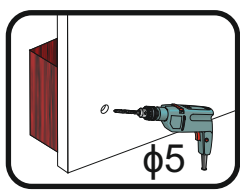

21 4x30 **x4**

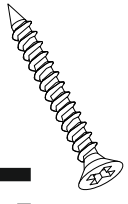
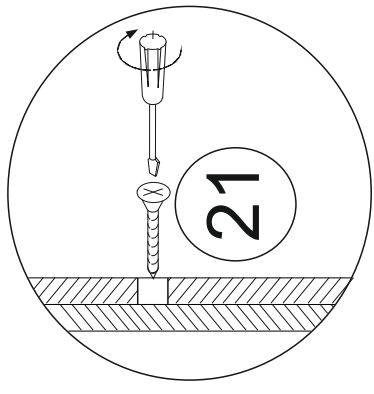
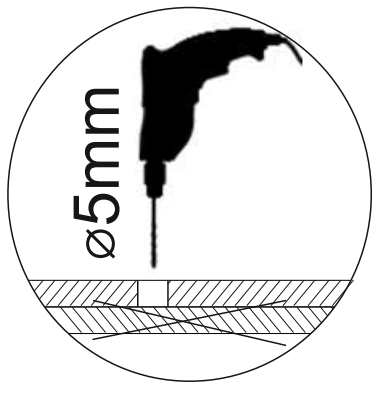
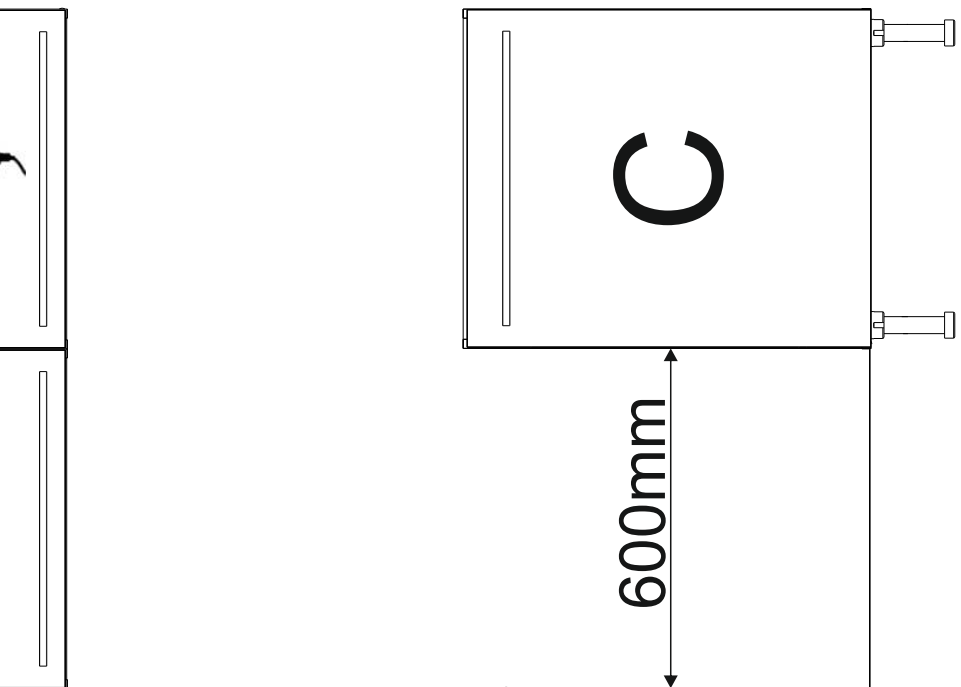
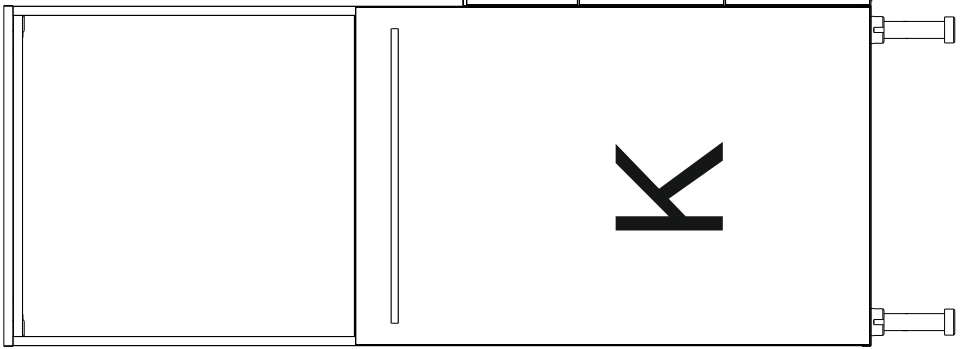

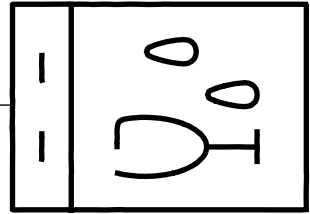
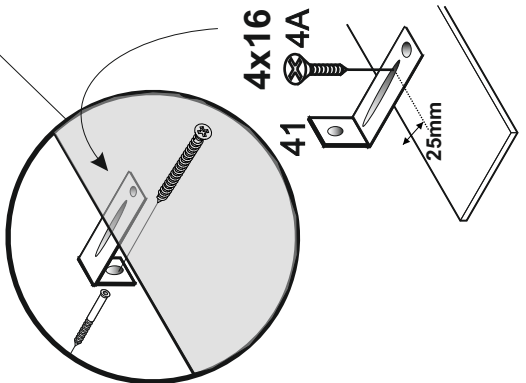
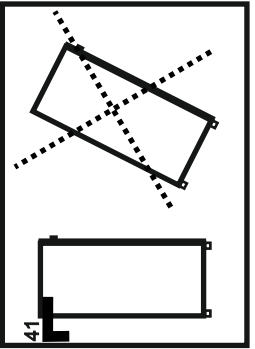
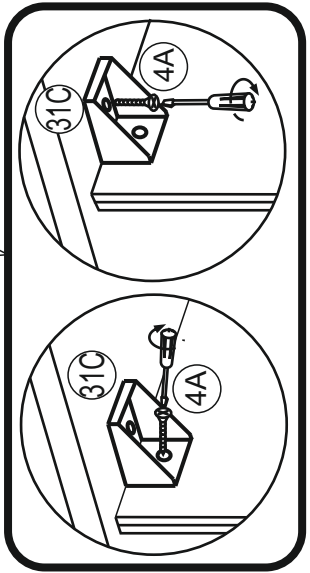
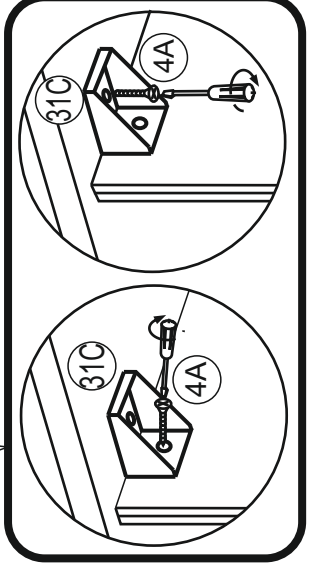
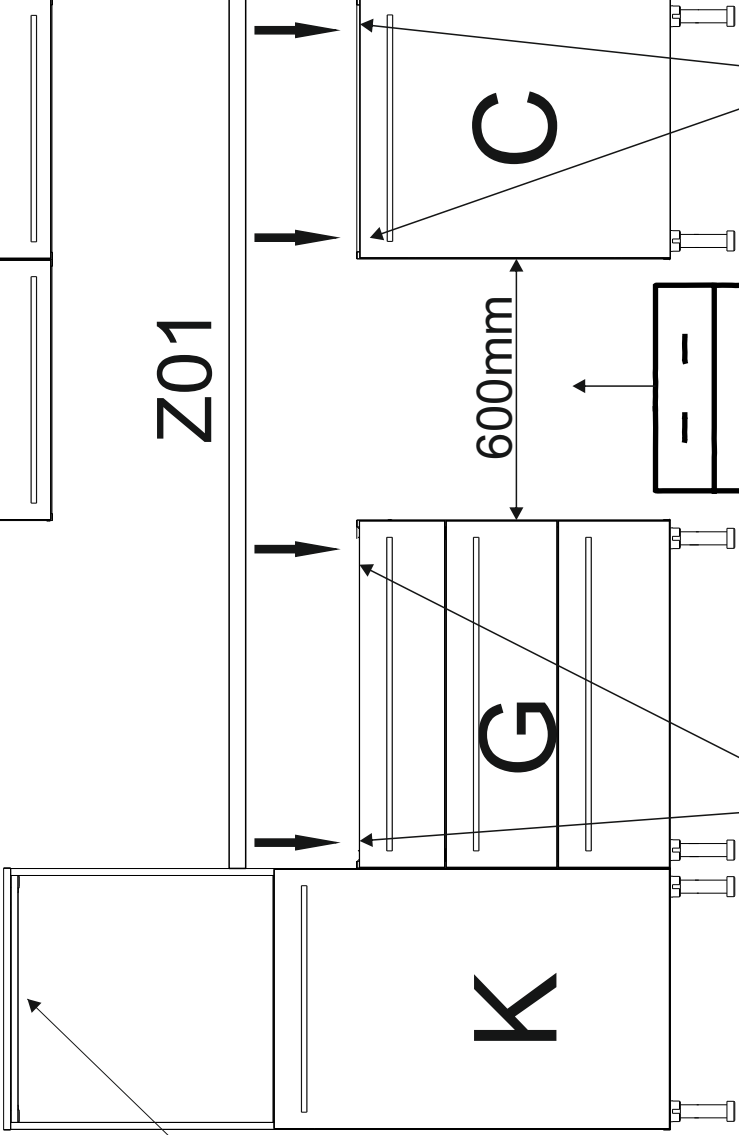
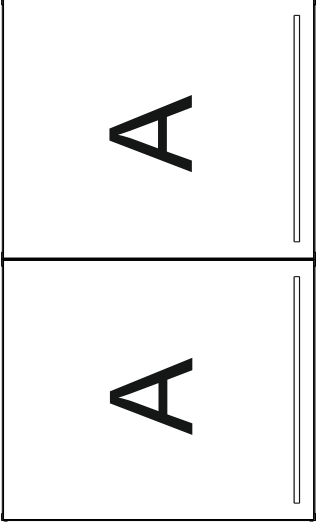
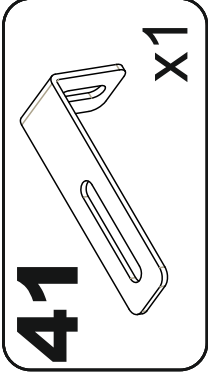
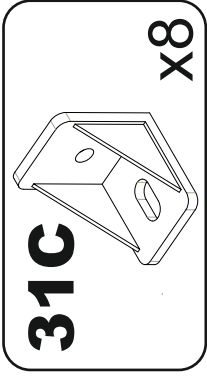
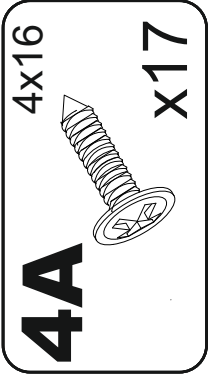
Erst wenn alles exakt steht, verbinden Sie die einzelnen Schränke mit Schrauben. Damit dabei nichts verrutscht, empfehlen wir Ihnen dringend den Einsatz von zwei Schraubzwingen. Die Schrankoberflächen schützen Sie mit Zulagehölzern vor Eindrücken.

Ermitteln Sie durch exaktes Messen die Positionen der Bohrungen für die Hängebeschläge

Legen Sie die Arbeitsplatte auf die Korpusse, richten Sie sie aus, und fixieren Sie sie mit Zwingen. markieren Sie die Lage und -breite des Herdunterschrankes.

Auf der Unterseite der Arbeitsplatte reißen Sie im markierten Bereich den Herdplattenausschnitt auf. Mitteln Sie sie aus, so dass die Spüle mittig im Unterschrank sitzt und vorne und hinten die Plattenrestbreite gleich wird.



Empfohlenes Vorgehen bei der Küchenmontage:

Bohren Sie in den vier Ecken jeweils ein 10-mm-Loch zum leichteren Einsetzen der Stichsäge, und schneiden Sie den Herdausschnitt entlang Ihrer Risse aus. Arbeiten Sie immer von der Plattenunterseite, damit die Plattenoberfläche durch die Stichsäge nicht ausfasert. Schalten Sie dazu auch den Pendelhub an Ihrer Stichsäge, sofern vorhanden, aus.

Zum Schutz der Holzteile können Sie rundum die Sockelteile eine Silikonnaht ziehen



Empfohlenes Vorgehen bei der Küchenmontage:

Bohren Sie in den vier Ecken jeweils ein 10-mm-Loch zum leichteren Einsetzen der Stichsäge, und schneiden Sie den Herdausschnitt entlang Ihrer Risse aus. Arbeiten Sie immer von der Plattenunterseite, damit die Plattenoberfläche durch die Stichsäge nicht ausfasert. Schalten Sie dazu auch den Pendelhub an Ihrer Stichsäge, sofern vorhanden, aus.

Zum Schutz der Holzteile können Sie rundum die Sockelteile eine Silikonnaht ziehen



Allgemeine Hinweise

Die Montage einer Einbauküche sollte von entsprechend geschulten Fachkräften durchgeführt werden. Vor der Montage müssen die Montagehinweise gelesen werden.

Spezielle, weiterführende Montageanleitungen und Hinweise liegen den Geräten, Spülen, Beleuchtungen und Sonderausstattungen bei und müssen zusätzlich beachtet werden.

Für die Befestigung von Wandhängeelemente gilt:



Wir legen kein Befestigungsmaterial bei. Bitte prüfen Sie die gegebene Wandbeschaffenheit und wenden Sie sich an den örtlichen Fachhandel zum Erwerb der passenden Dübel / Haken / Aufhängeschienen / Schrauben

Für die Aufhängung können entweder Haken oder Aufhängeschienen verwendet werden.



Die Hängeschränke können bei korrekter Montage mit ca. 40 kg belastet werden. Achten Sie auf eine gleichmäßige Lastverteilung

Bei Nichtbeachtung der Montagehinweise können wir entstandene Schäden keine Haftung übernehmen

Achten Sie darauf bei Einzelschränken, oder der gesamten Küchenzeile eine Kippsicherung anzubringen

Sanitär- und Elektroinstallationen dürfen nur von einer entsprechenden Fachkraft vorgenommen werden

Vor Bohrarbeiten muss geprüft werden, dass an der Stelle des Bohrens keine Leitungen für Gas, Wasser, Strom, Heizung oder

Abflüsse verlegt wurden

Es dürfen keine verändernden Manipulationen am Zubehör oder an Elektrogeräten vorgenommen werden. Dies gilt insbesondere für Befestigungsbohrungen.

Überprüfen Sie vor der Montage ob alle Anschlüsse vorhanden sind und fachgerecht ausgeführt wurden

Die Küche beinhaltet verschluckbare Kleinteile. Kinder unter 3 Jahre nicht ohne Beaufsichtigung lassen



Empfohlenes Vorgehen bei der Küchenmontage:

Planen Sie den genauen Montageort unter Berücksichtigung Ihrer Sanitär- und Elektroanschlüsse

Prüfen Sie ob Ihr Kühl- Gefriergerät Lüftungsauslässe im Sockelbereich bzw. im Bereich der Arbeitsplatte benötigt

Erwerben Sie ggf. passende Lüftungsgitter im Fachhandel und schneiden Sie den Sockel bzw. die Arbeitsplatten gemäß den Anweisungen des Geräteherstellers aus.

Legen Sie fest, ob Sie die Türen mit Rechts- oder Linksanschlag montieren wollen

Montieren Sie zunächst die Unterschränke und richten Sie diese mit einer Wasserwaage aus.

