

980884

1.

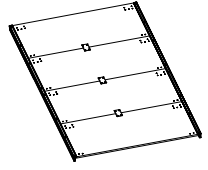

2.

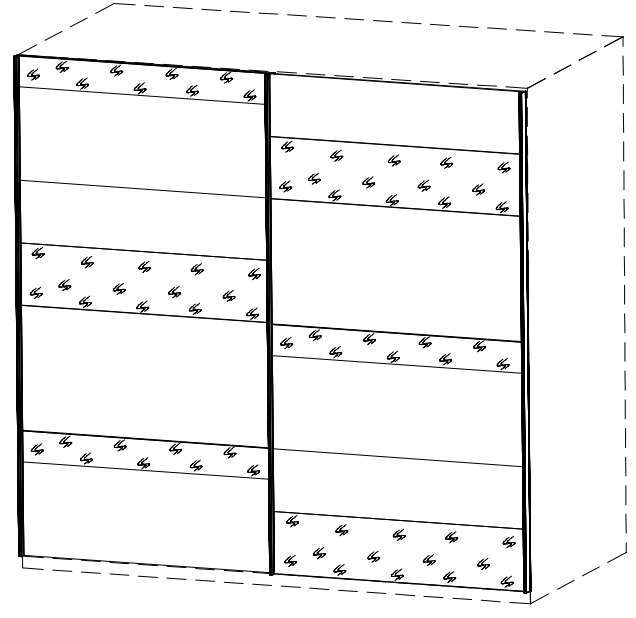
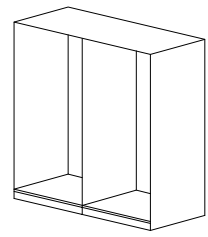
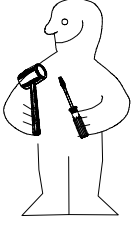

250-125-0

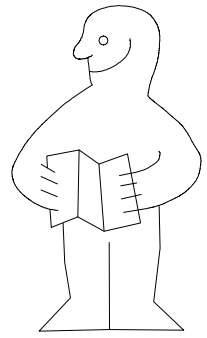
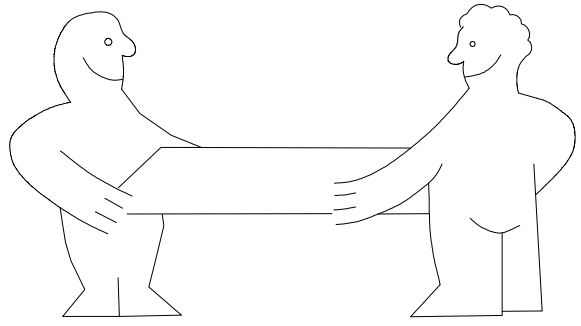
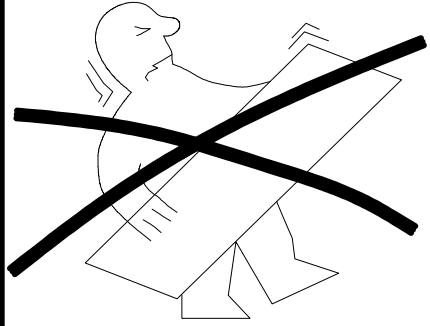

1-2-3-4... ○

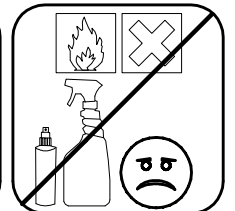
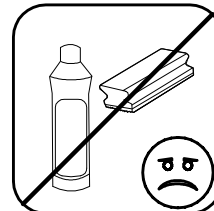
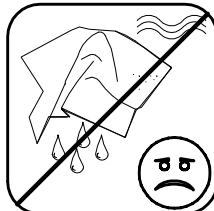
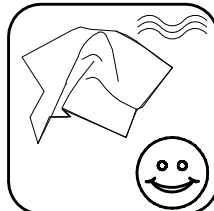
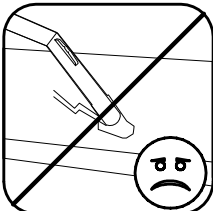
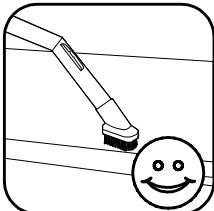
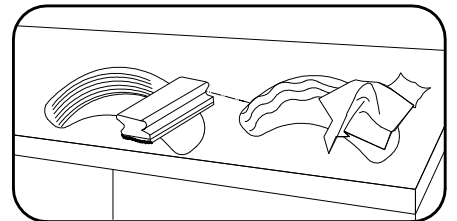
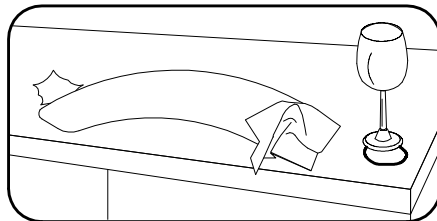
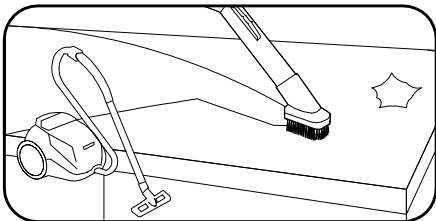
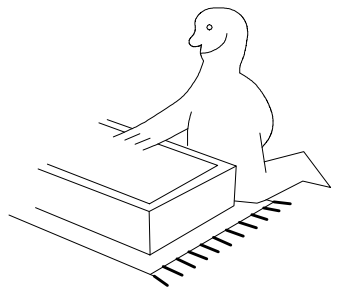
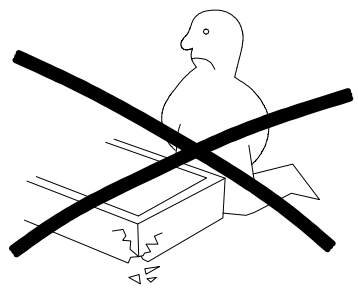
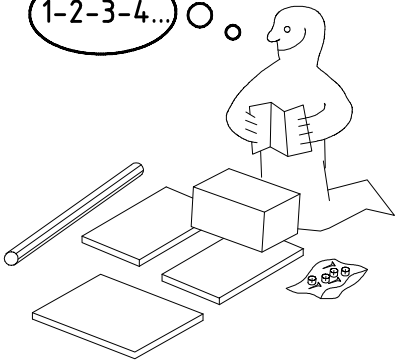

980884

26.11.12 / 03.10.15

10 15

1/4

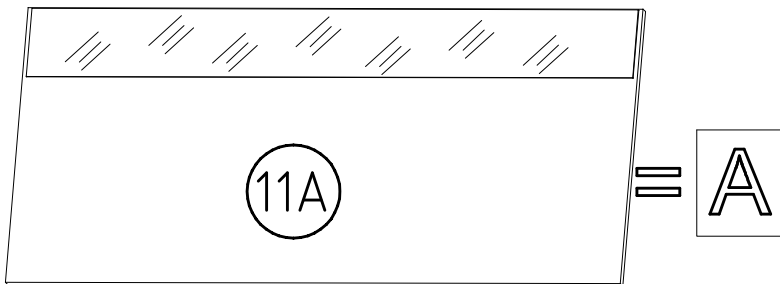
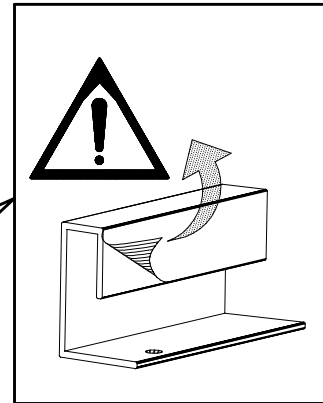
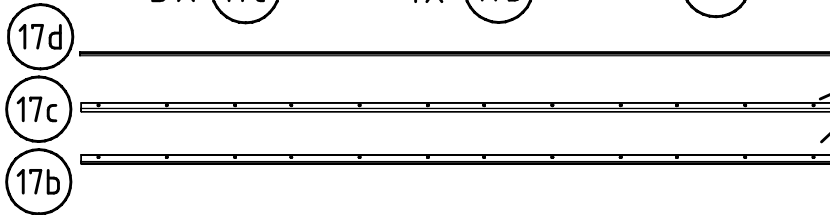
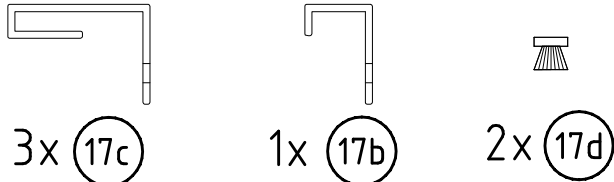
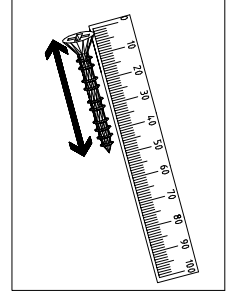
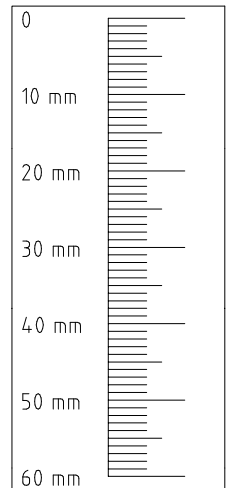
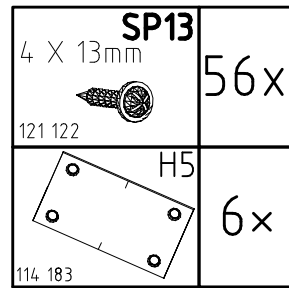
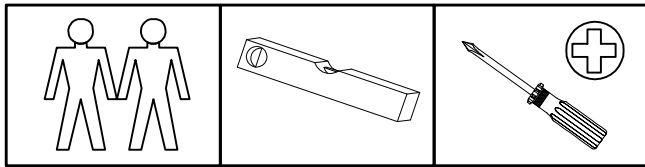

3x 695 / 916 / 1135 / 1357 / 1579 x 504 x 15

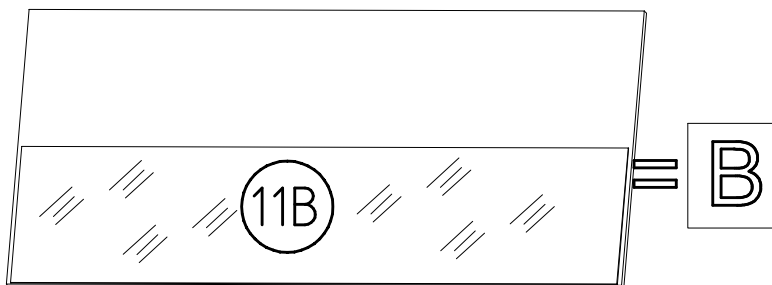

3x 695 / 916 / 1135 / 1357 / 1579 x 504 x 15

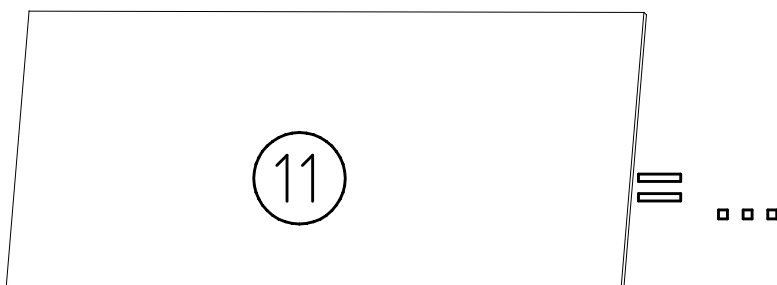

2x 695 / 916 / 1135 / 1357 / 1579 x 504 x 15

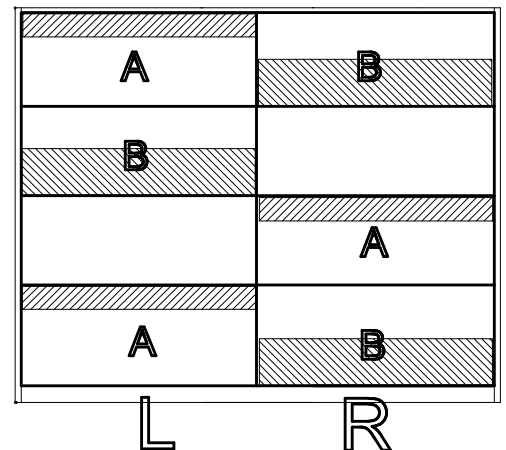
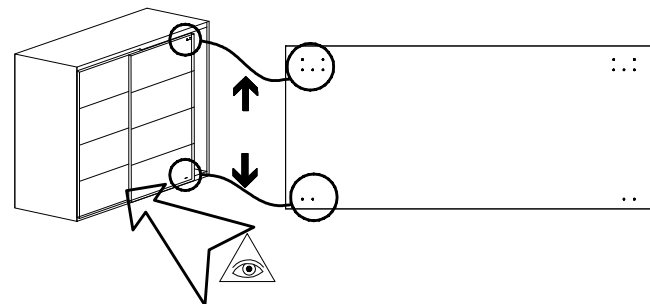

1

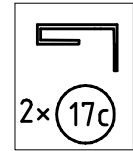
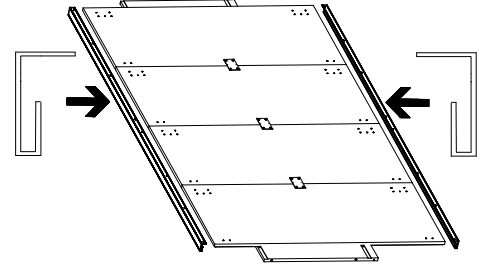
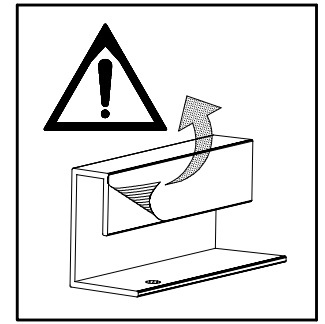
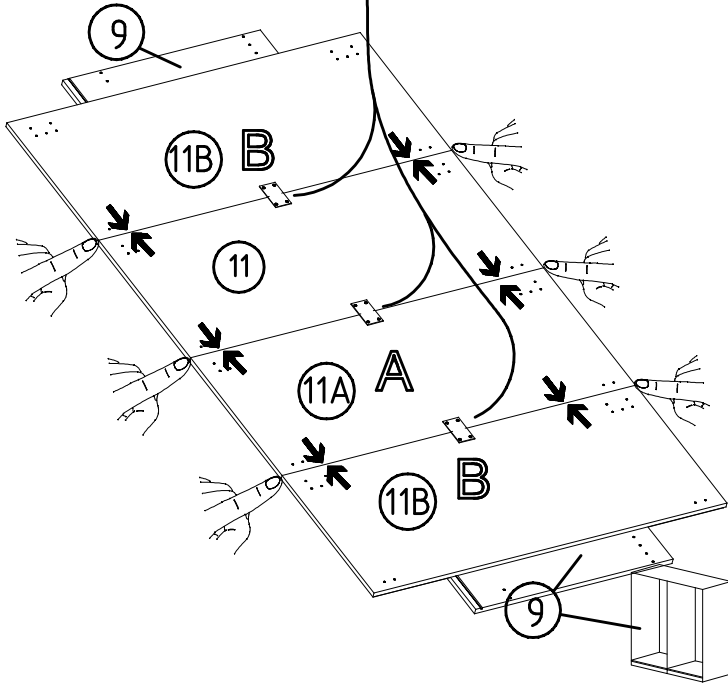
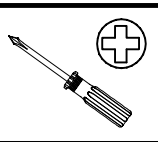
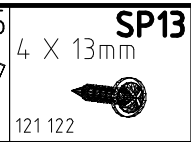
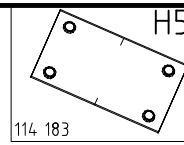
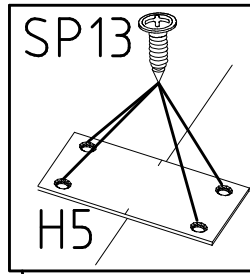
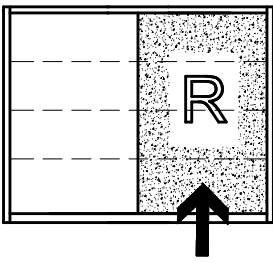

2

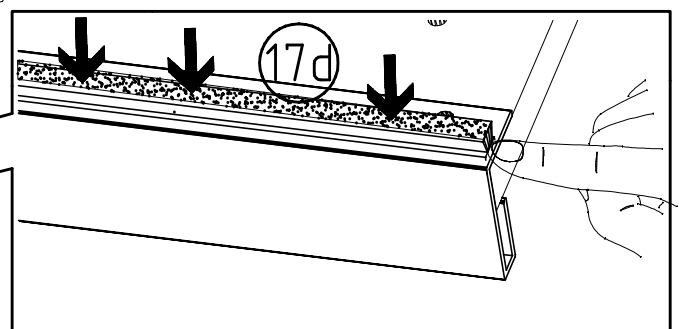
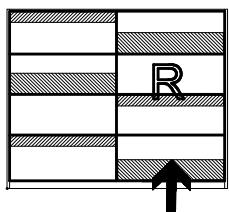
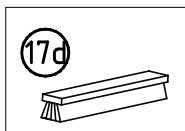
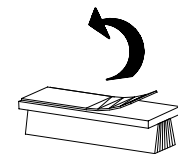
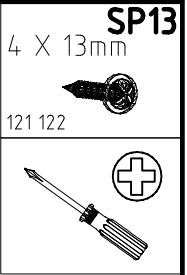
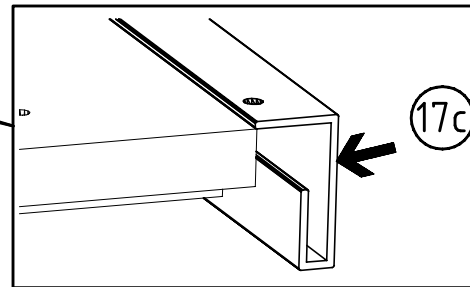
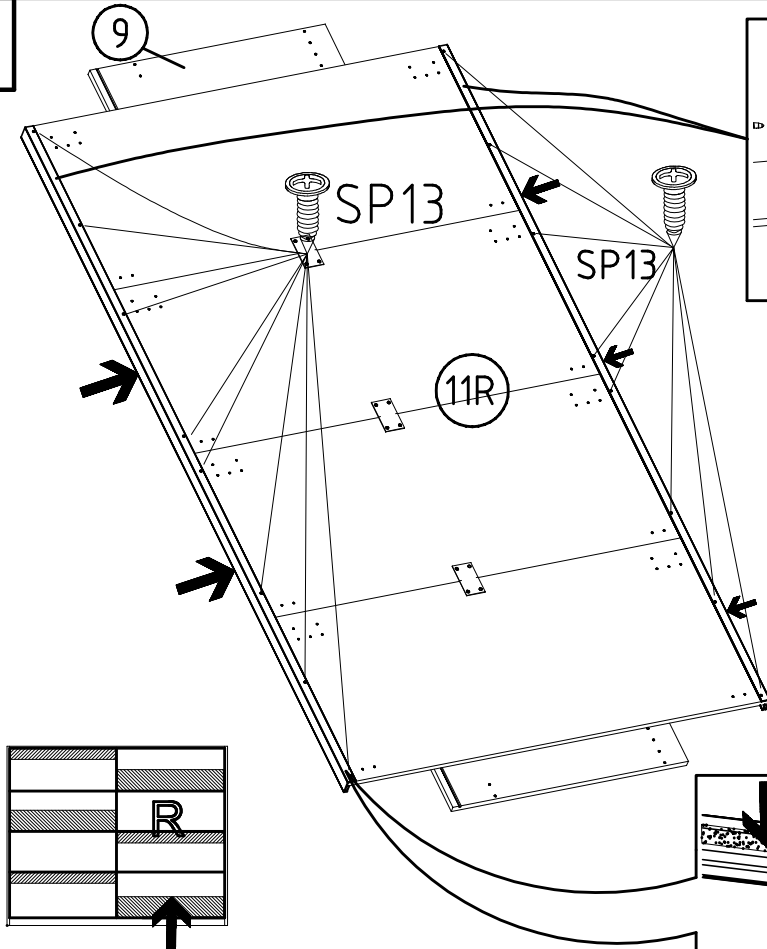

3

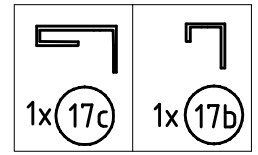
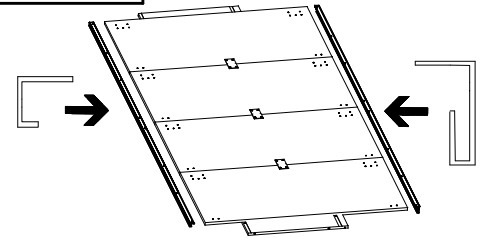
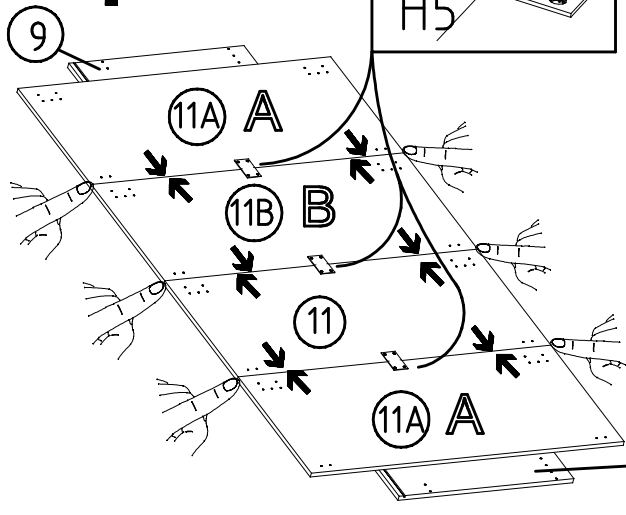
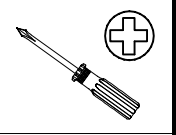
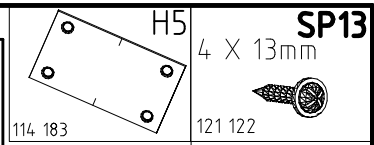
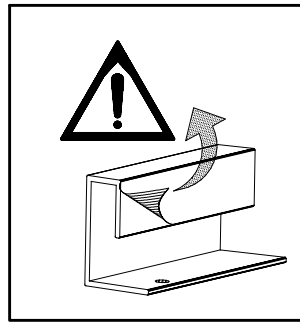
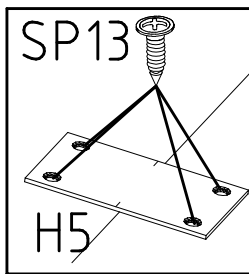
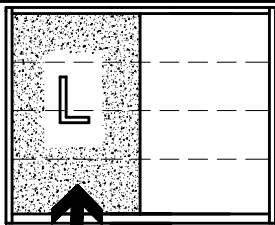

4

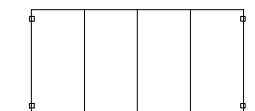
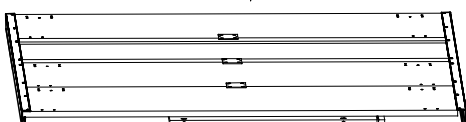
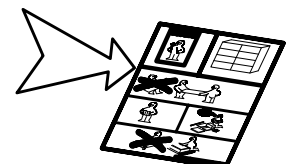
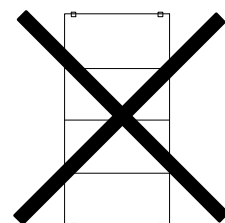
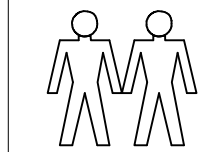
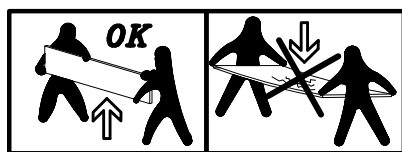
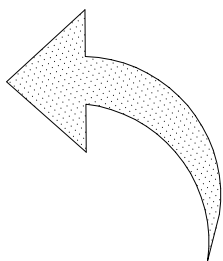
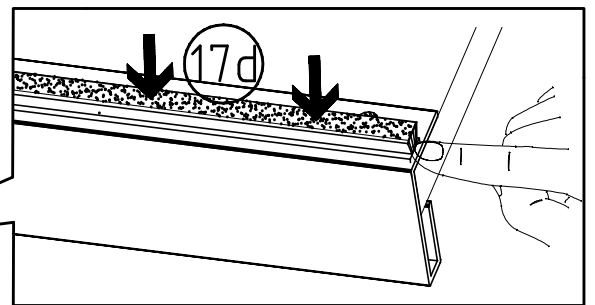
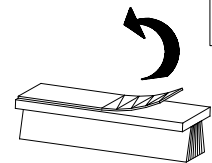
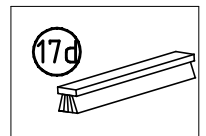
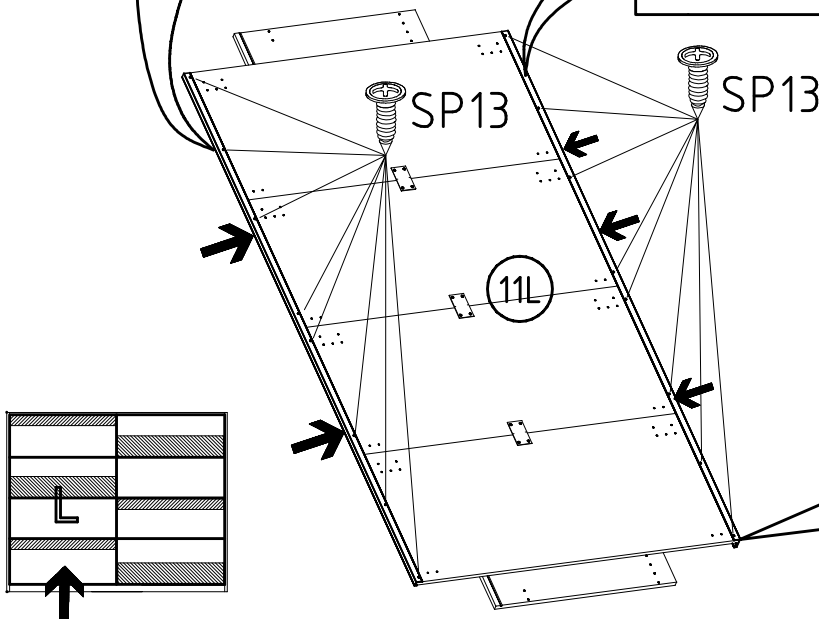
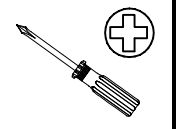
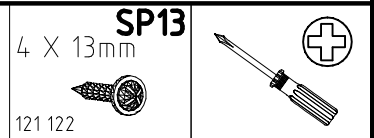
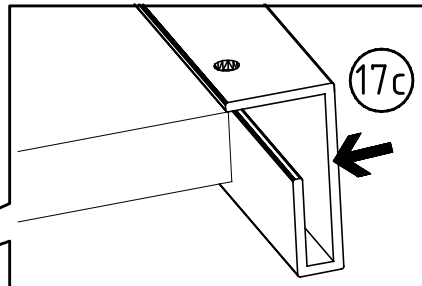
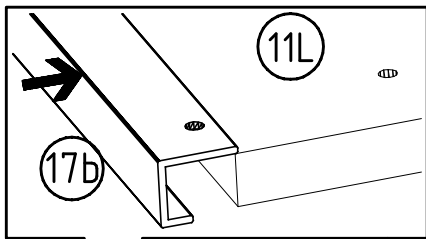

980862

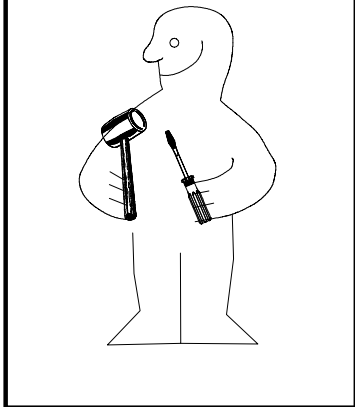

1.

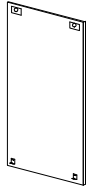

2.

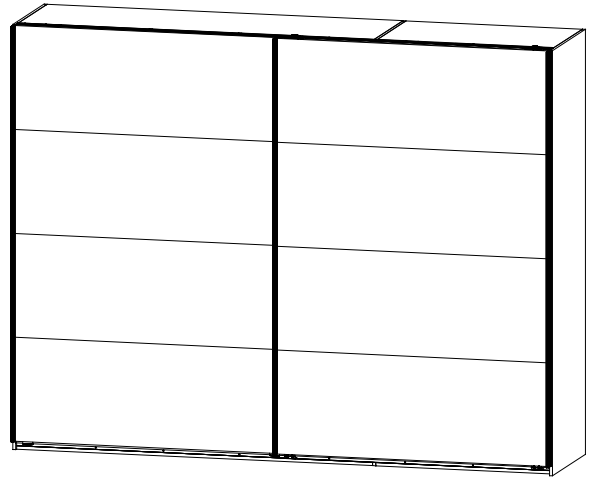
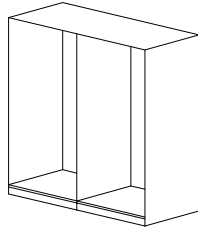

H 270

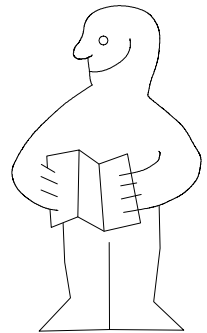
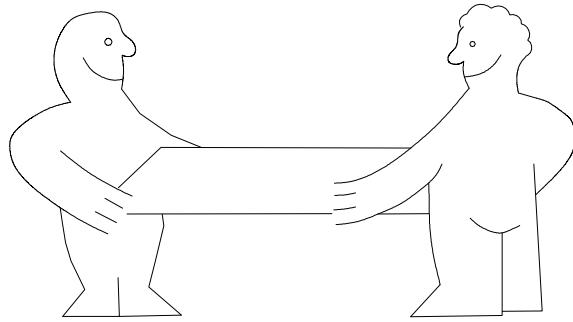
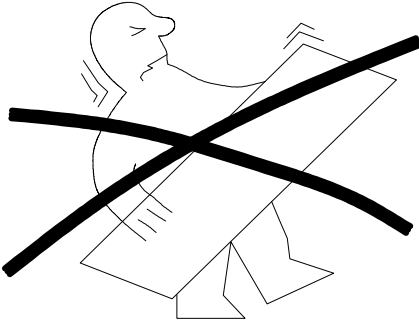

1-2-3-4... ○ ○

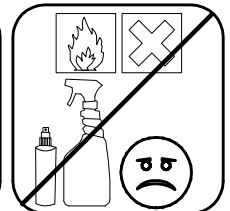
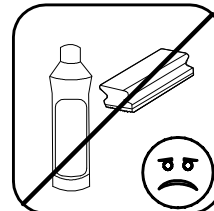
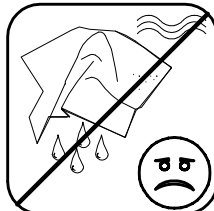
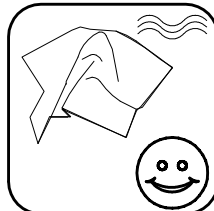
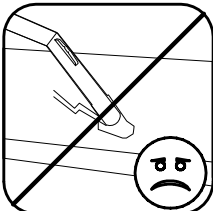
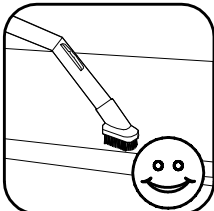
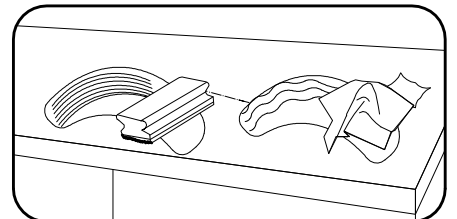
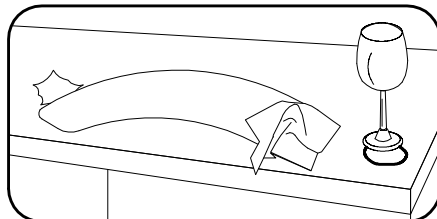
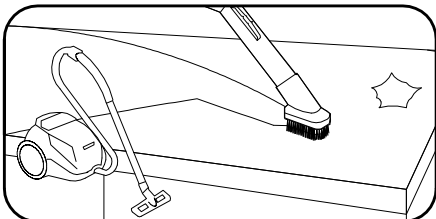
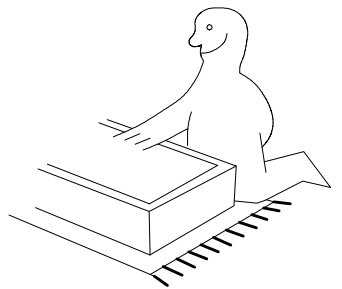
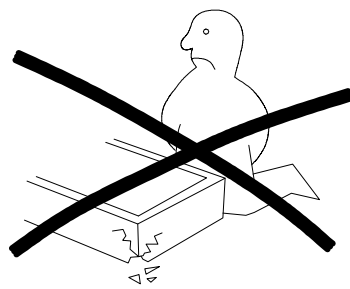
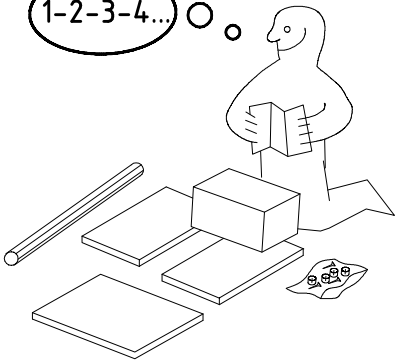

980862

12.12.12 / 15.08.15

08 15

1/16

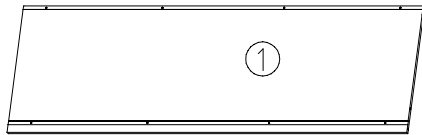
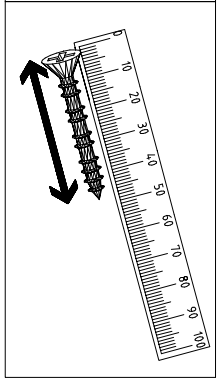
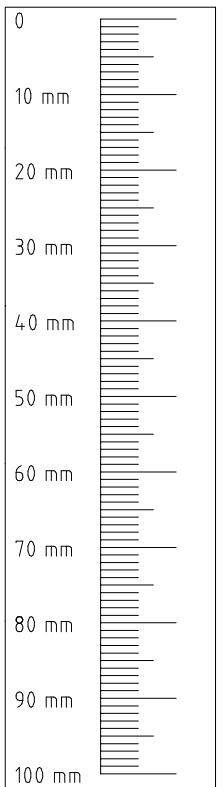
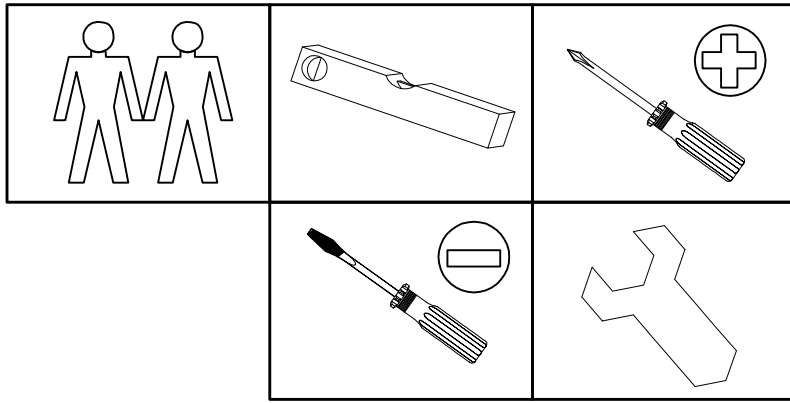

1761x560x15



1761x32x15



1761x32x15

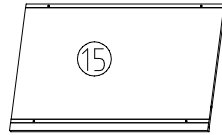

873x560x15

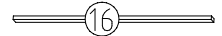

873x32x15



873x32x15

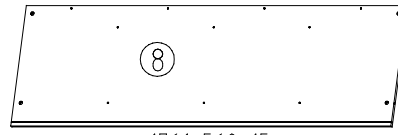

1761x560x15

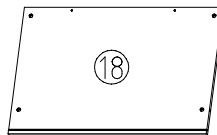

873x560x15

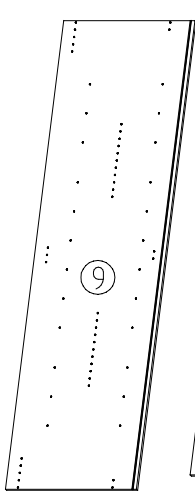

2064x577x15

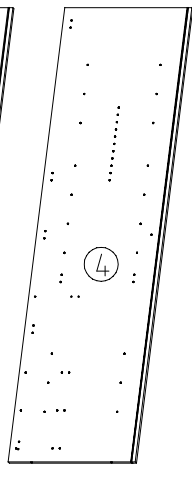

2001x560x15

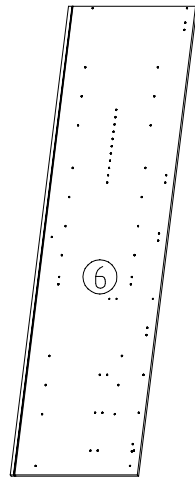

2064x560x15

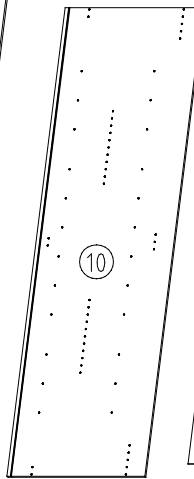

2064x607x15

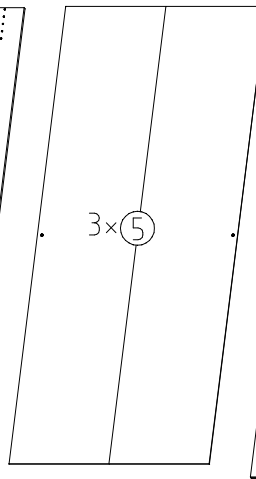

2015x882x2,5

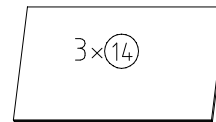

3x14

873x500x18

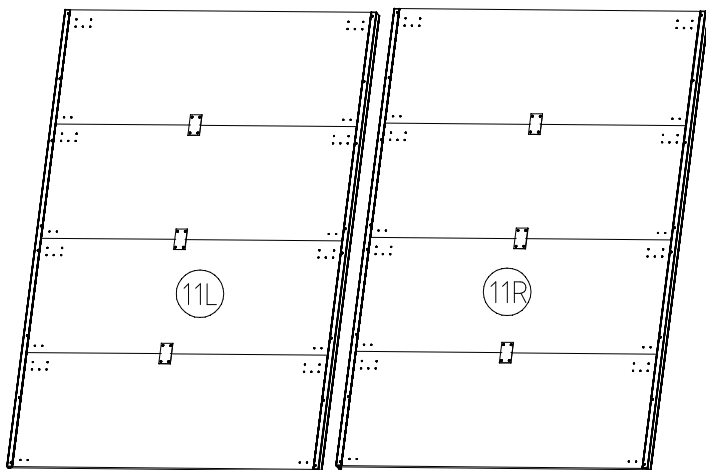
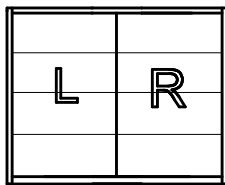

2018x1357x15

2018x1357x15

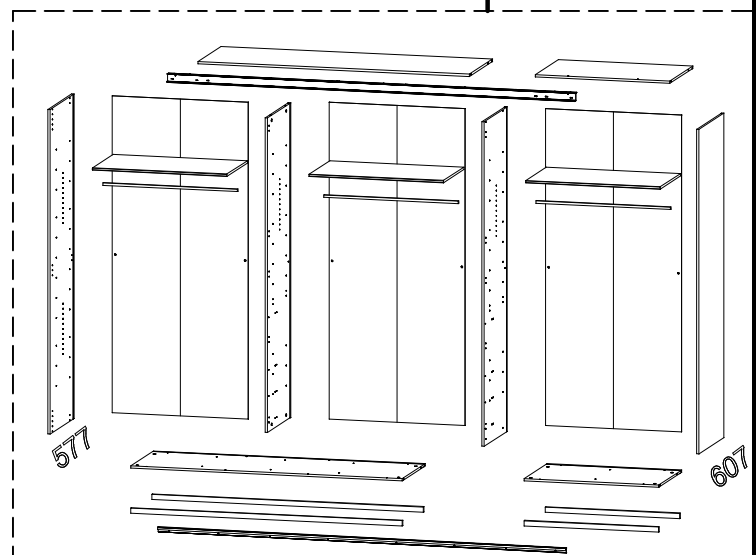

980862

12.12.12 / 15.08.15

08 15

2 / 16

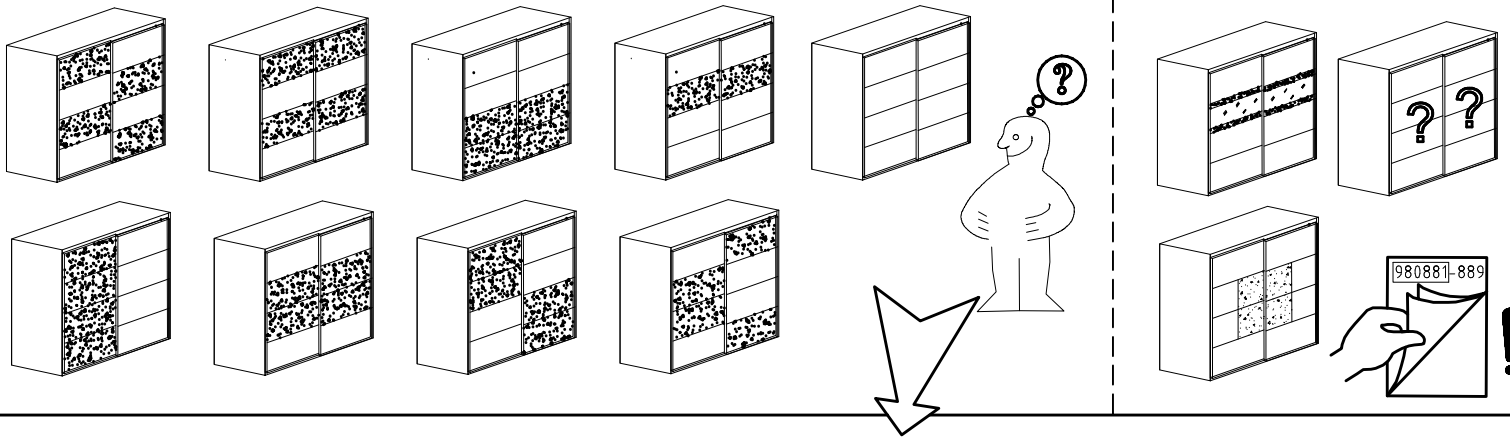

1x **FPN**  
 1316/1760  
 2204/2648/3092/3536

1x **LP**  
 1316/1760  
 2204/2648/3092/3536

	<b>SWH1</b>	2x
	<b>SWH2</b>	1x
	<b>SWH3</b>	1x
	<b>SWH-D</b>	1x

	<b>SWH 6</b>	2x
	<b>SWH 7</b>	2x
	<b>SWH-SKL</b>	1x
	<b>SWH-SKR</b>	1x

	<b>SWH-ST</b>	2x
	<b>SWH-MS</b>	2x
	6,3 x 10,5 mm T2	24x
	114 183	6x

	<b>SP13</b> 4 X 13mm	65x
	121 122 3,5 x 22 mm	<b>G24</b>
	121 004 M4 x 13 mm	<b>GH13</b>
	121 xxx M4 x 10 mm	<b>G43</b>

	<b>A</b>	20x
	<b>C</b>	12x

	<b>F3</b>	4x
	<b>J1</b>	6x

	<b>L7</b>	12x
	<b>K1</b>	6x

	<b>K20</b> 870mm	3x
	112 402 3,5 x 15 mm	<b>G1</b>

	<b>G14</b> 3,5 x 35 mm	14x
	121 375 M6 x 11 mm	<b>T6</b>

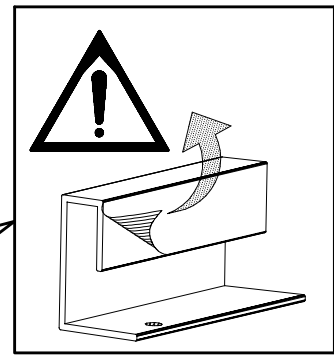
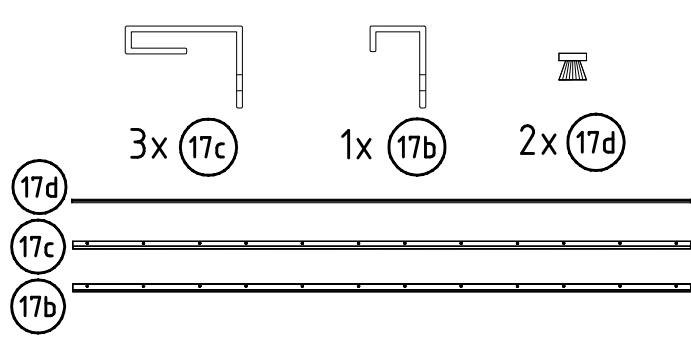

**11** 8x  
 1357 x 504 x 15

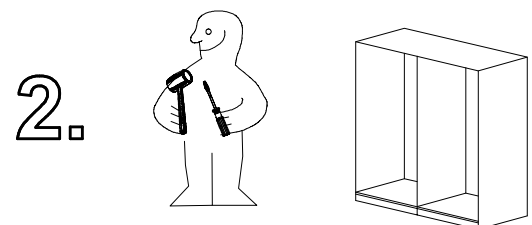
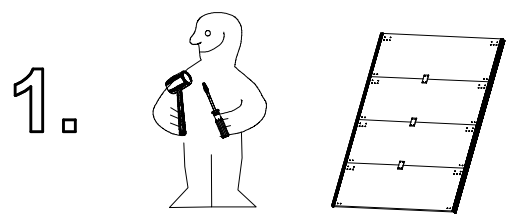
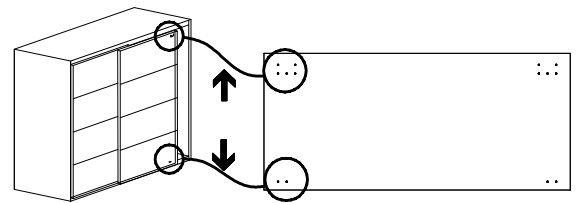

1

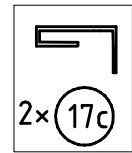
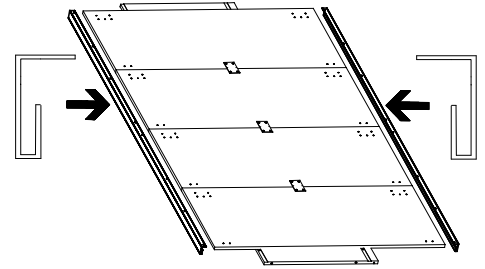
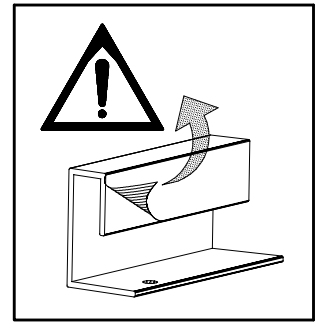
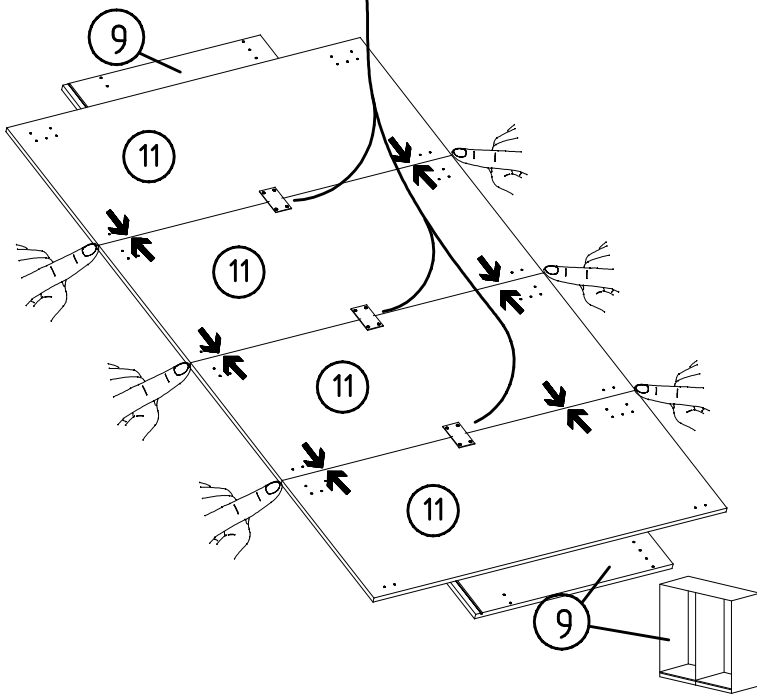
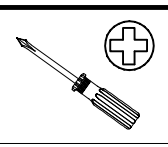
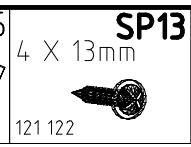
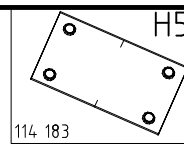
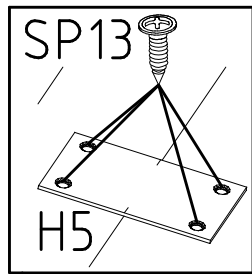
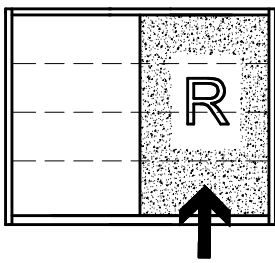

2

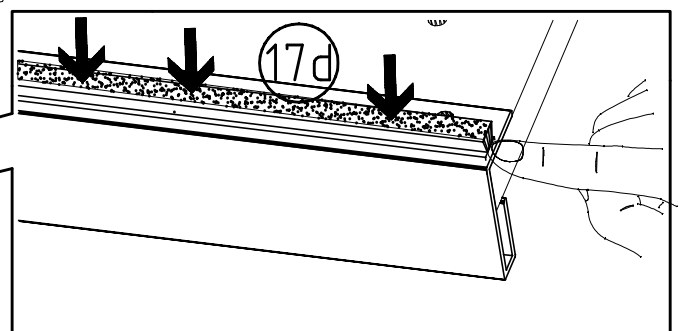
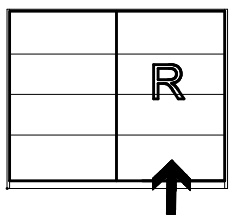
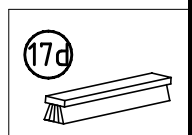
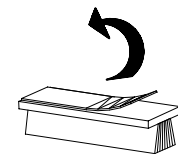
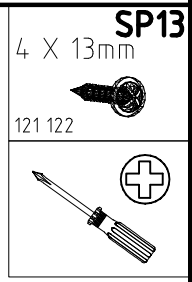
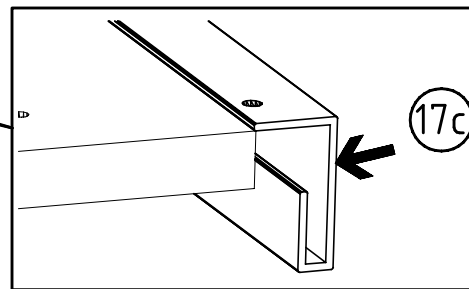
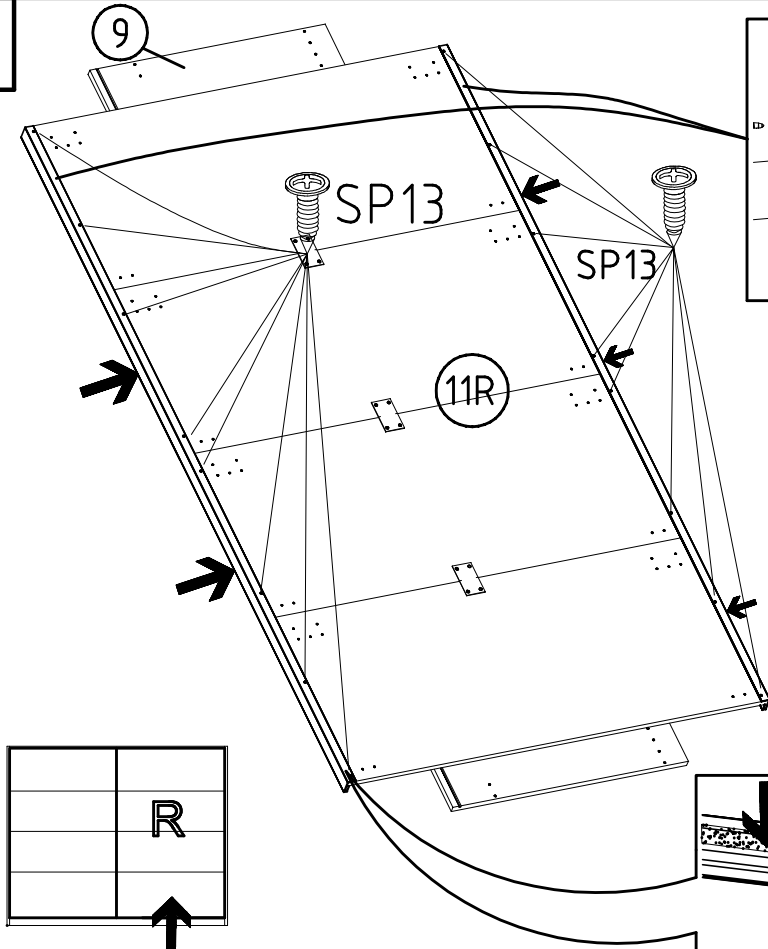



3

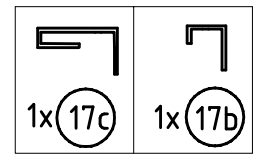
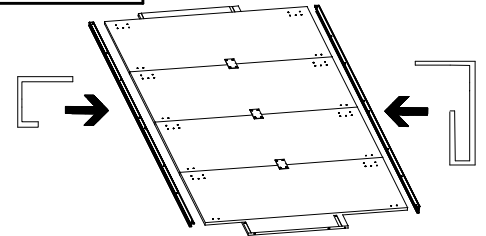
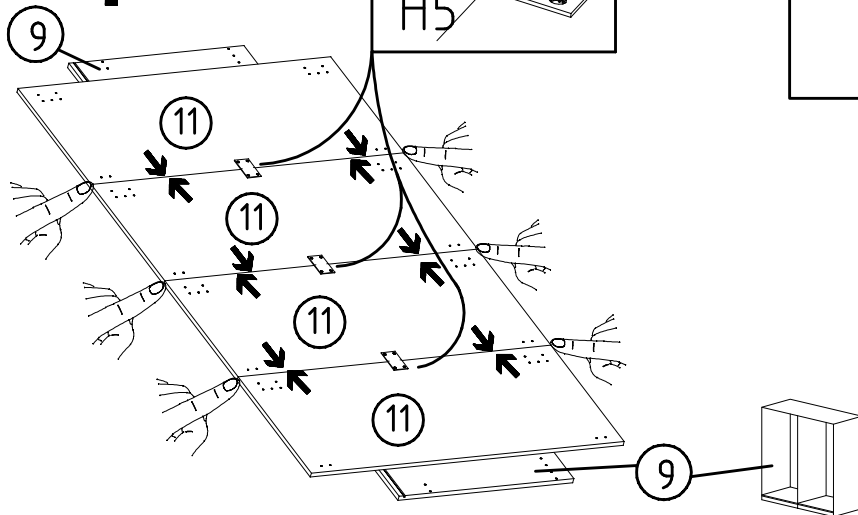
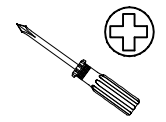
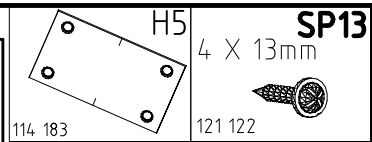
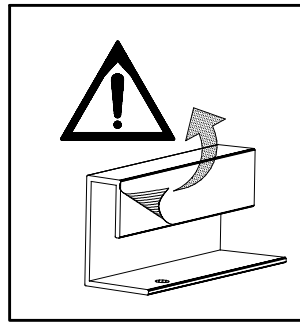
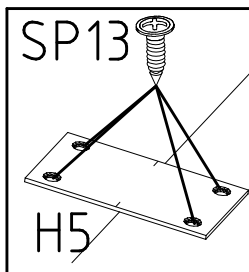
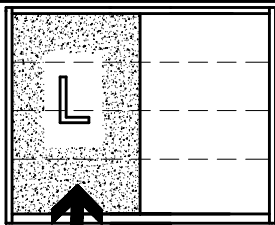

4

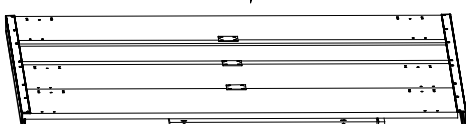
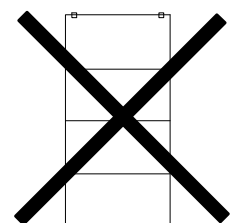
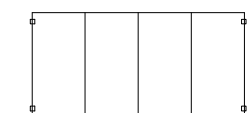
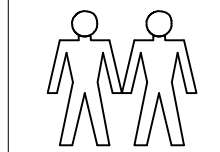
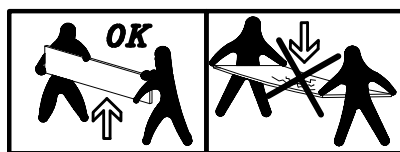
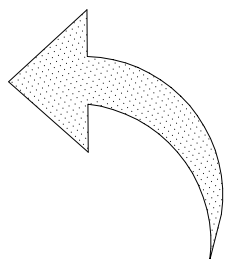
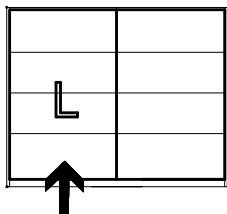
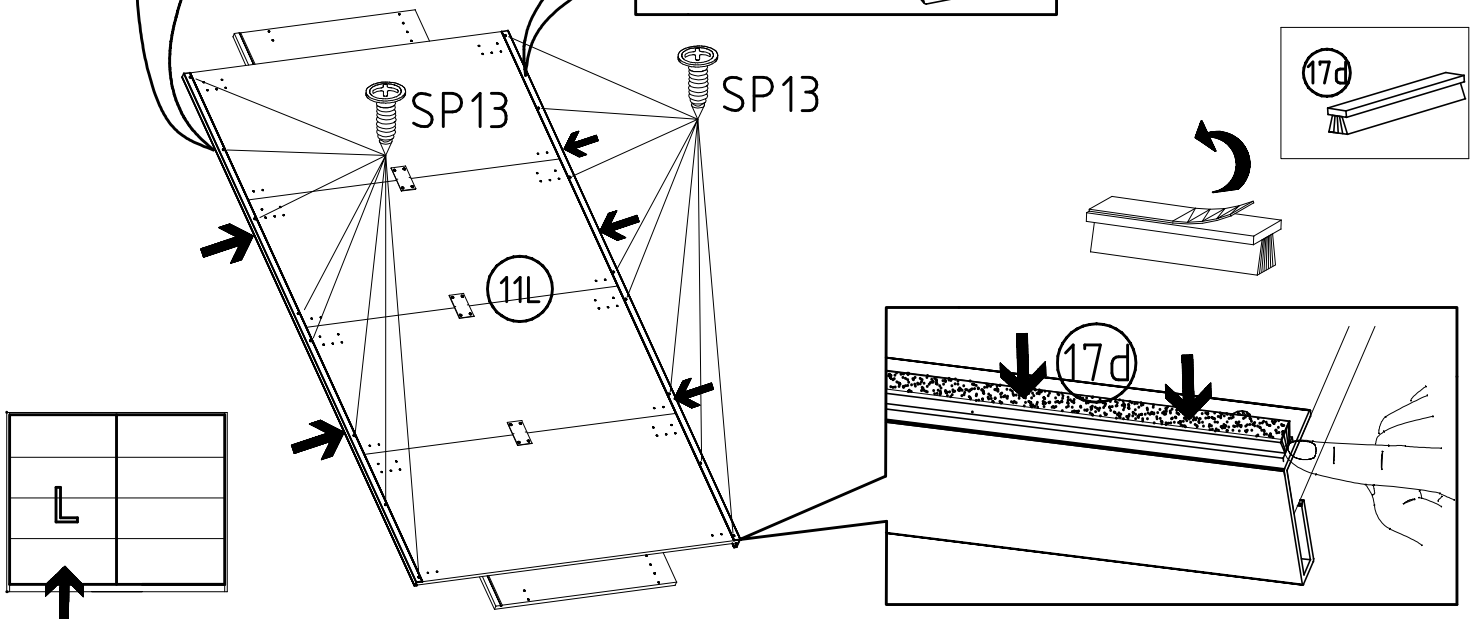
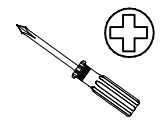
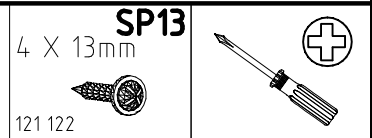
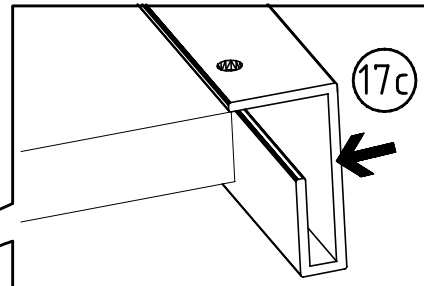
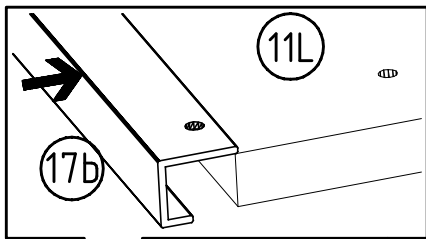

5

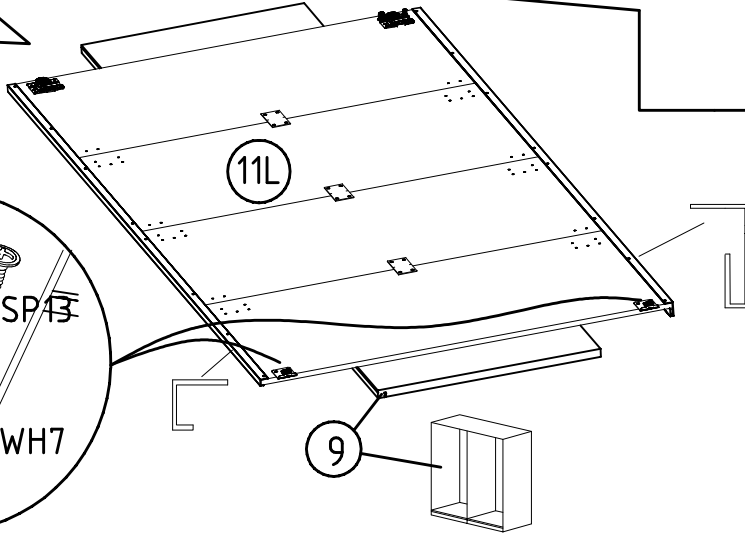
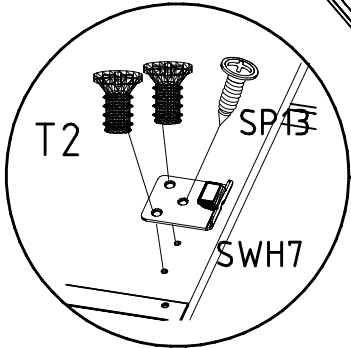
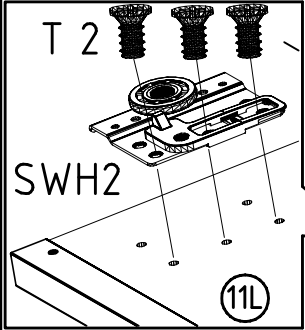
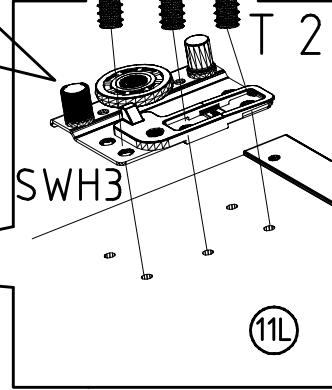
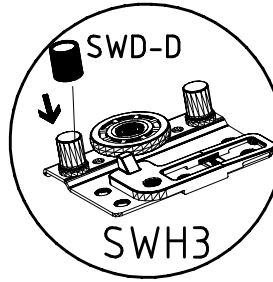
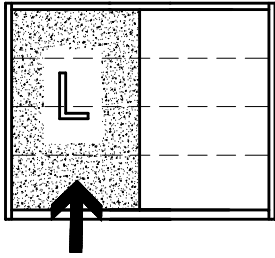

SWH2

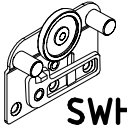

SWH3

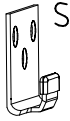

SWH7

SWH-D



6,3 x 10,5 mm T2



111.030

SP13

4 X 13mm



121 122

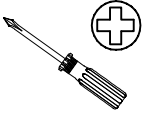

6

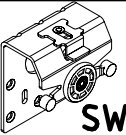
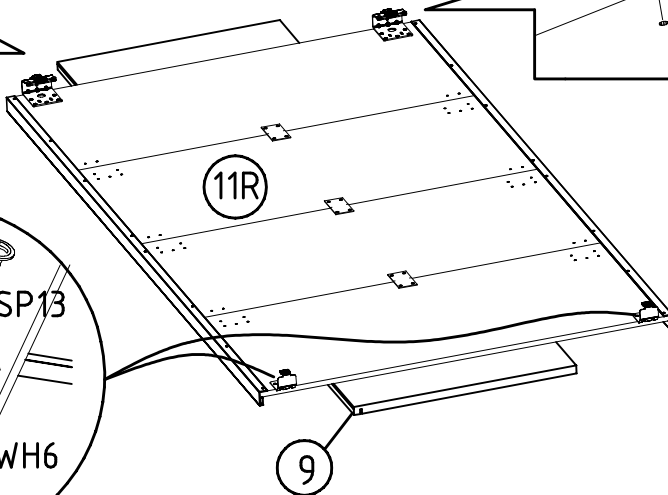
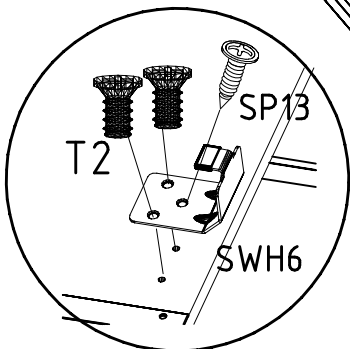
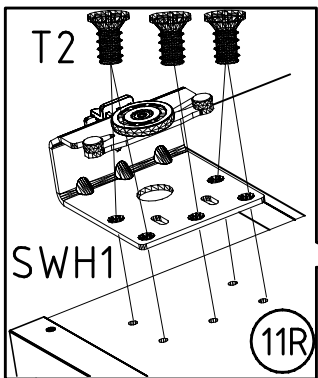
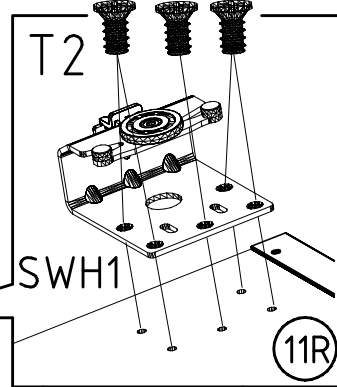
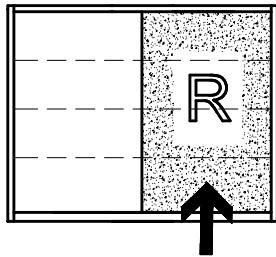

SWH1

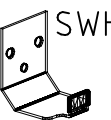

SWH6

6,3 x 10,5 mm T2



111.030

SP13

4 X 13mm



121 122

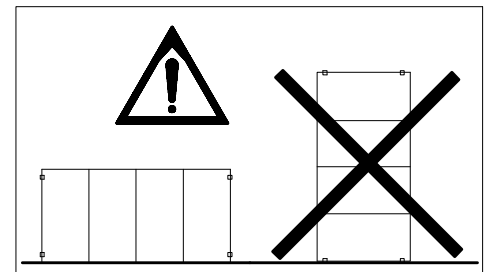
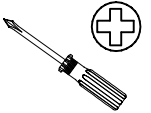

7

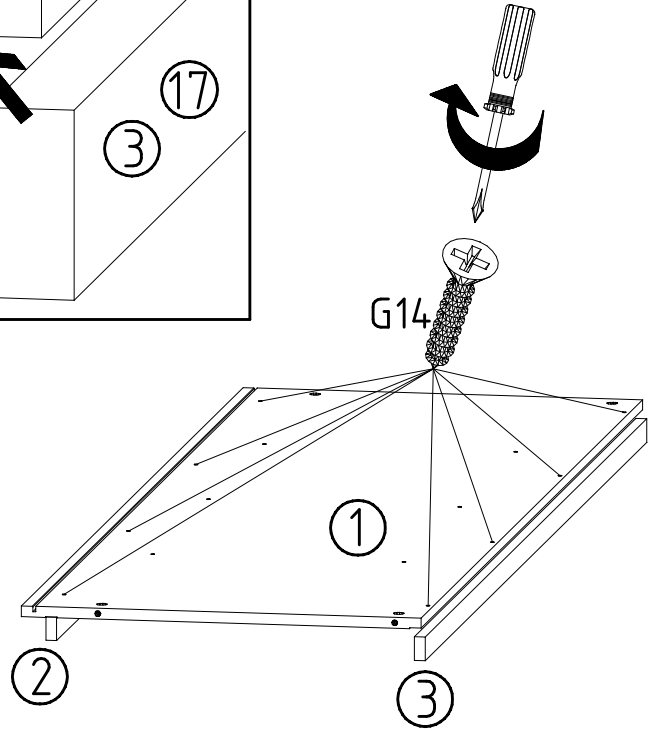
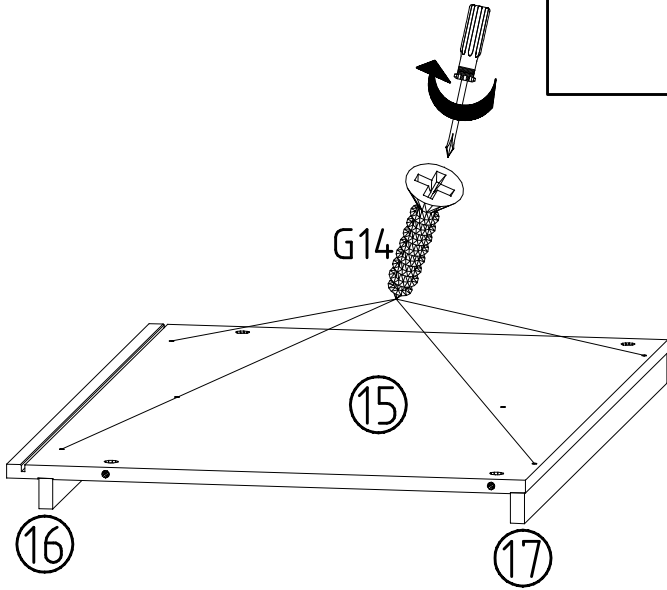
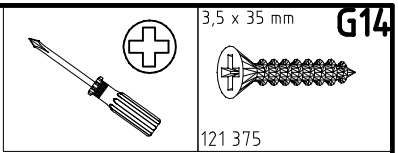
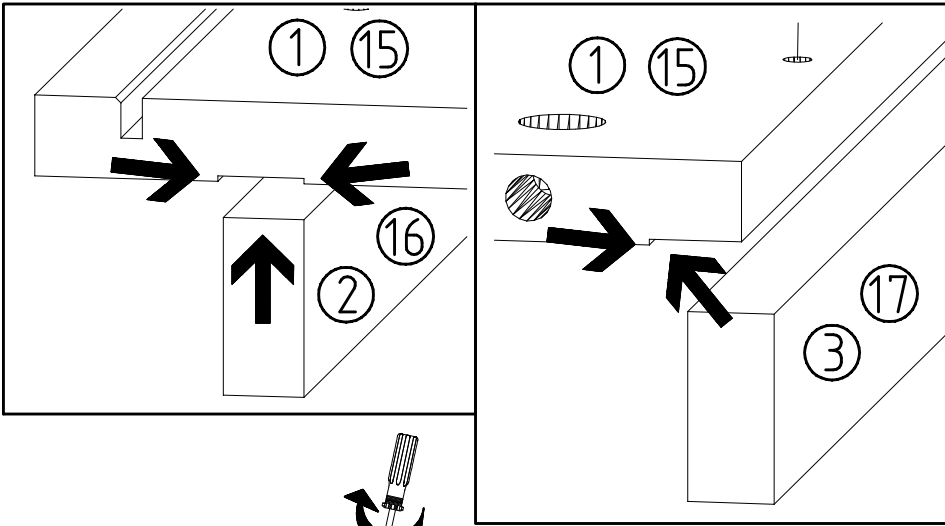

8

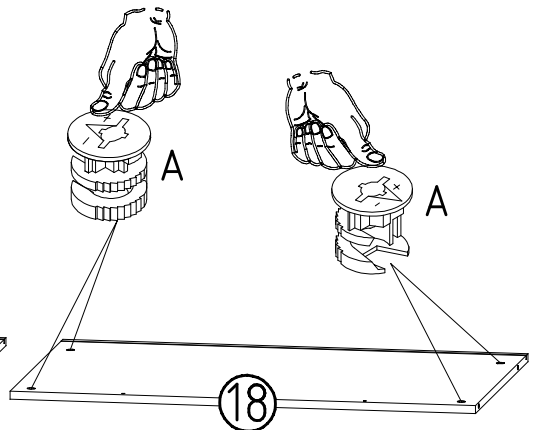
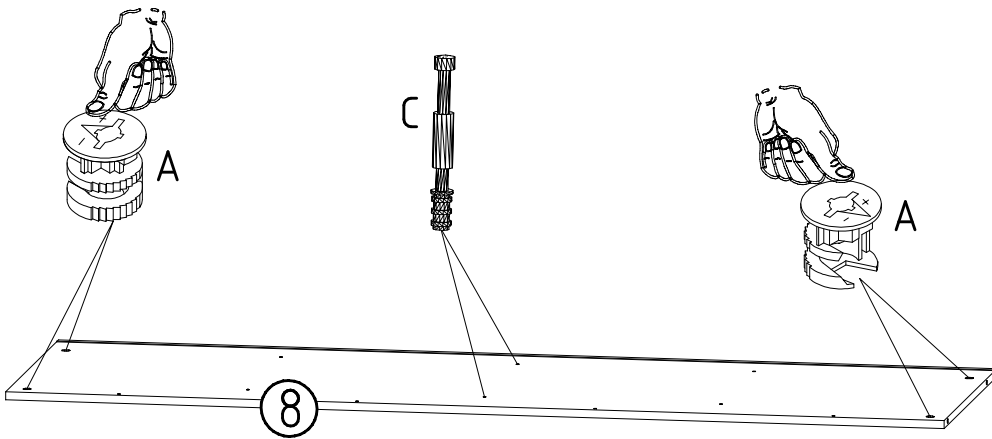
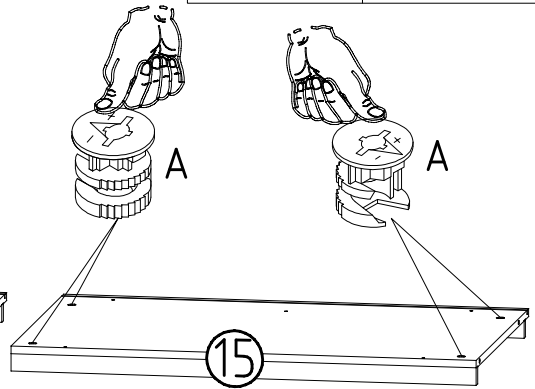
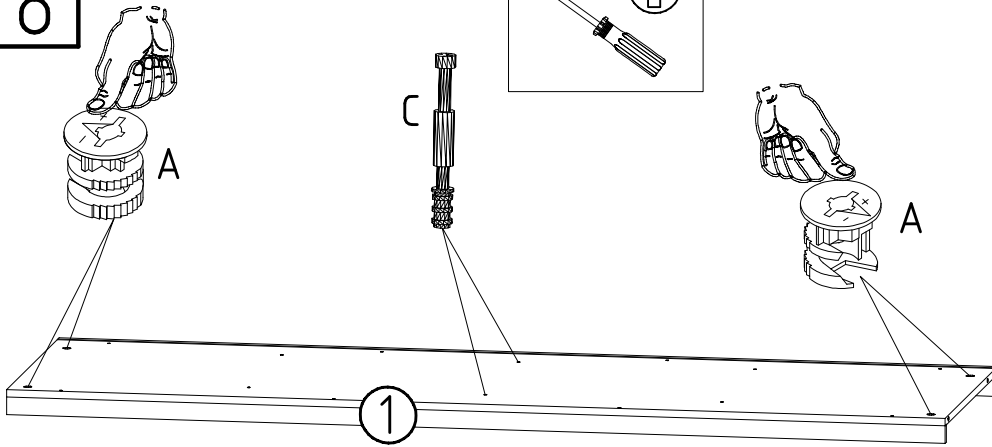
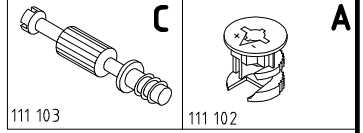
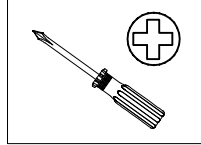

9

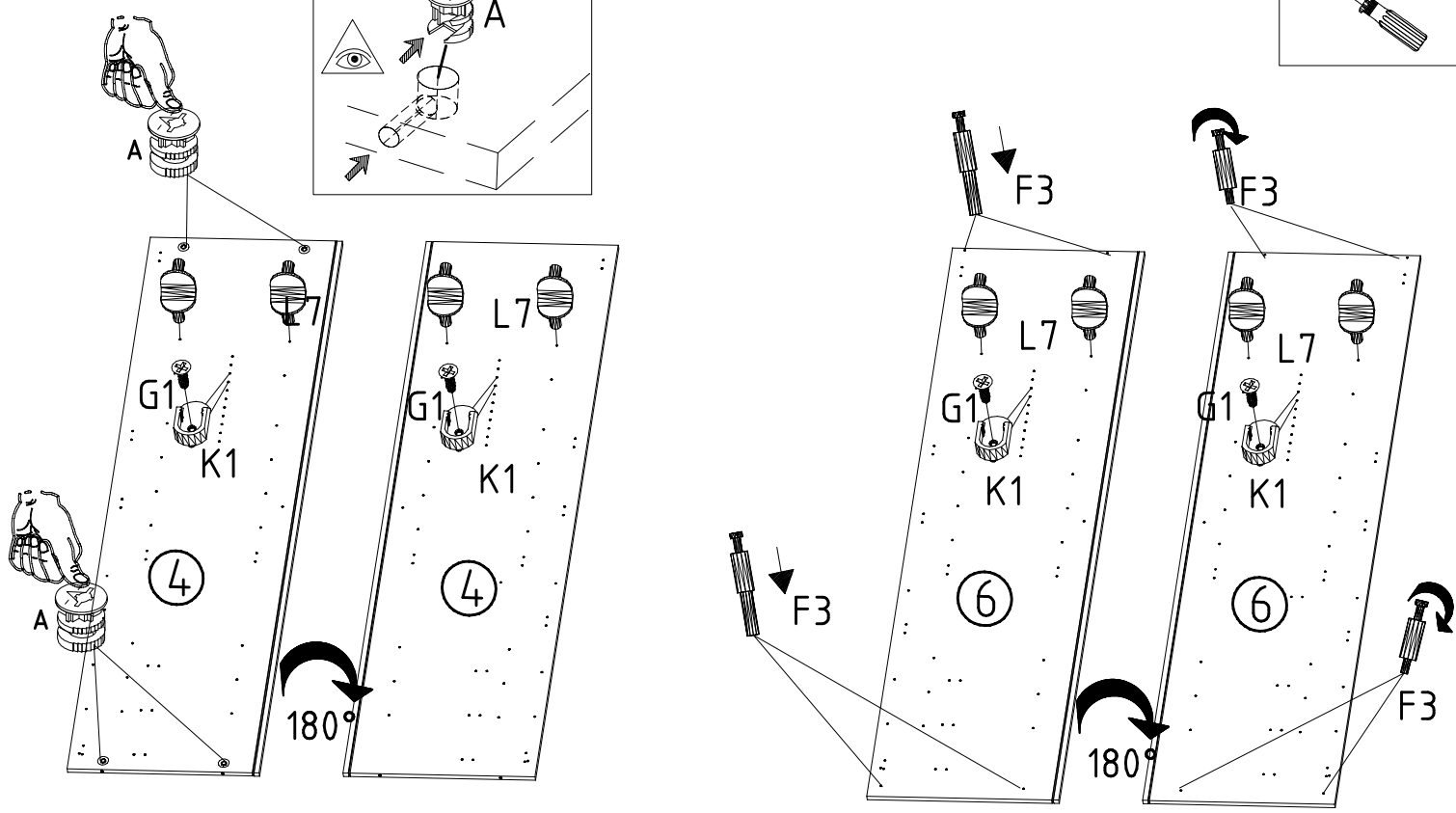
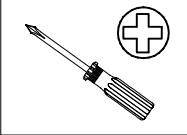
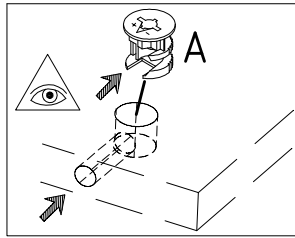
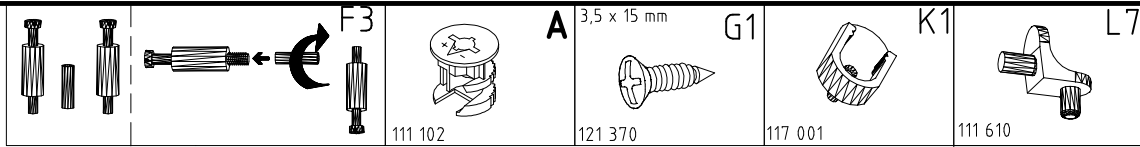

10

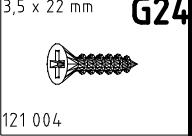
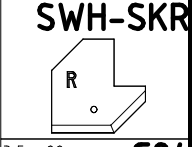
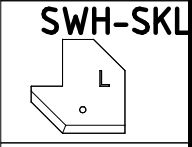
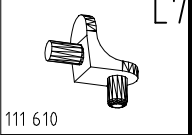
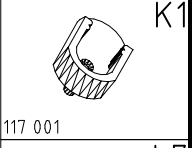
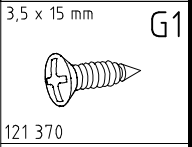
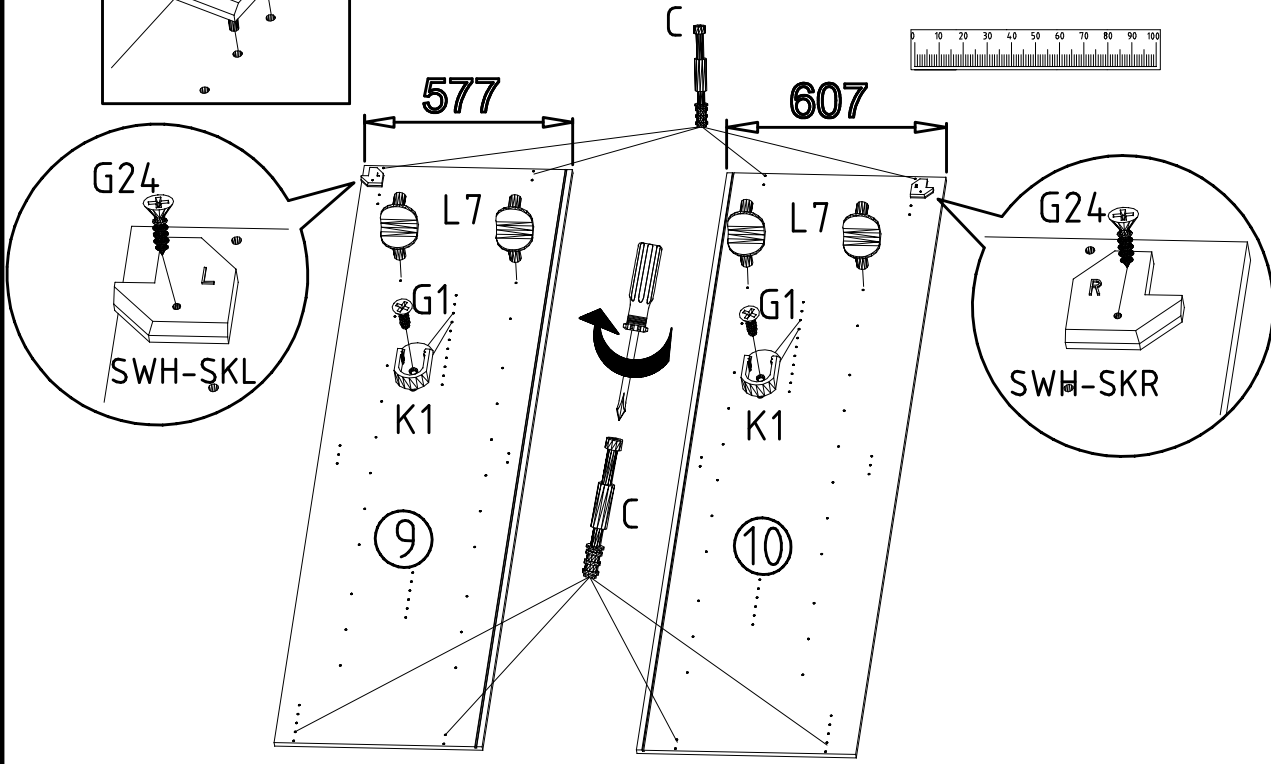
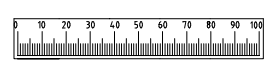
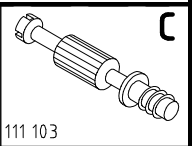
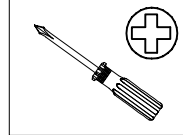
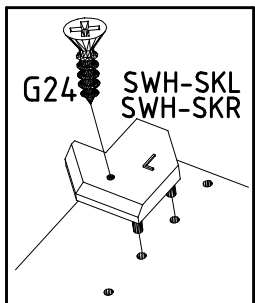

11

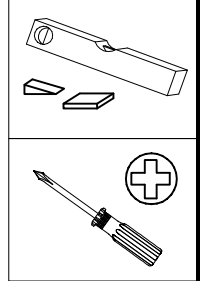
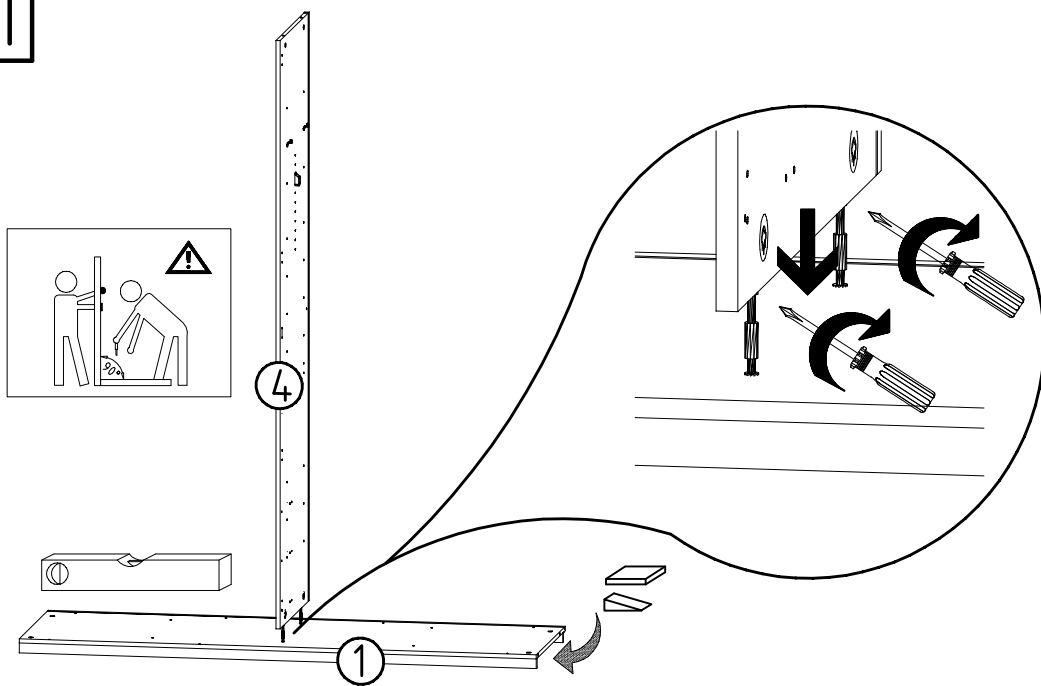

12

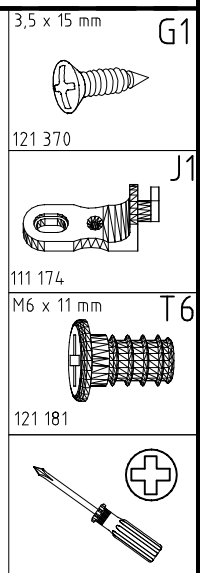
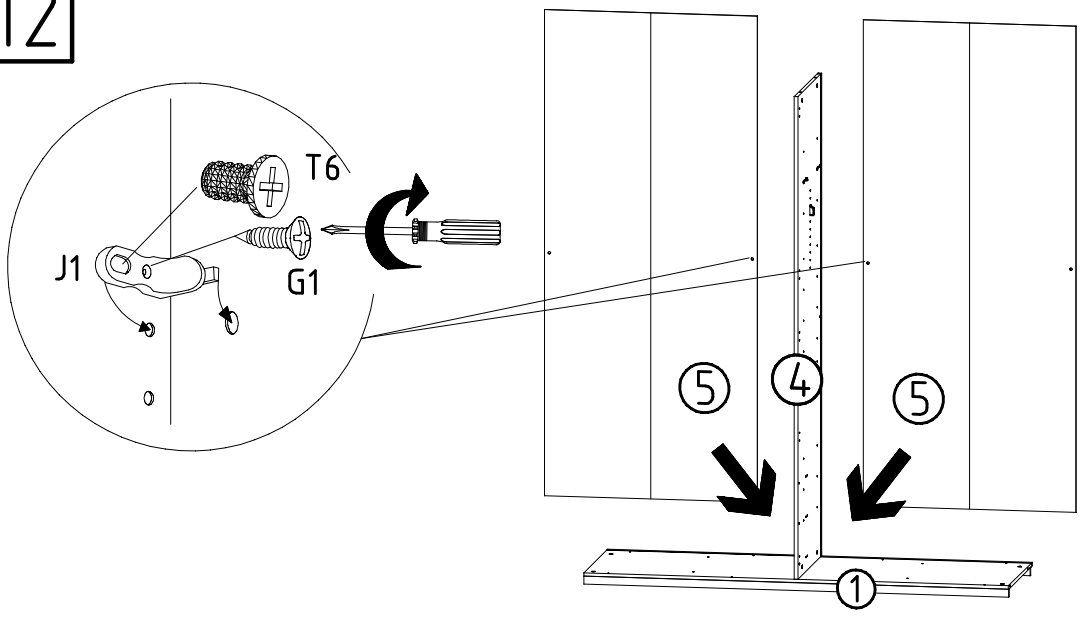

13

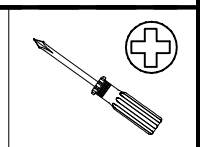
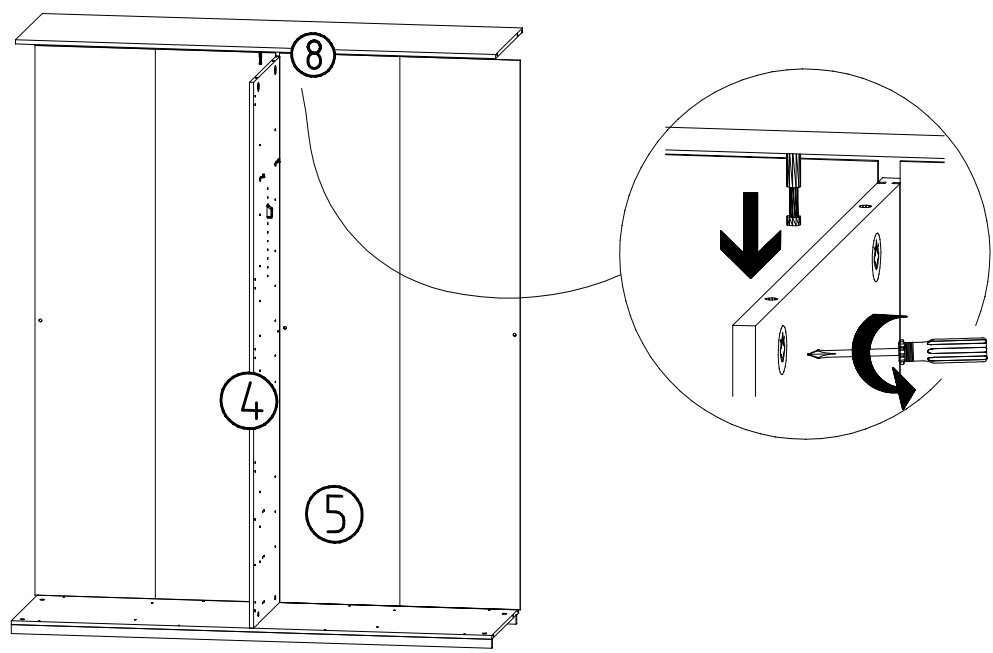

14

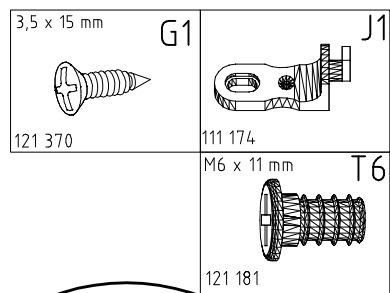
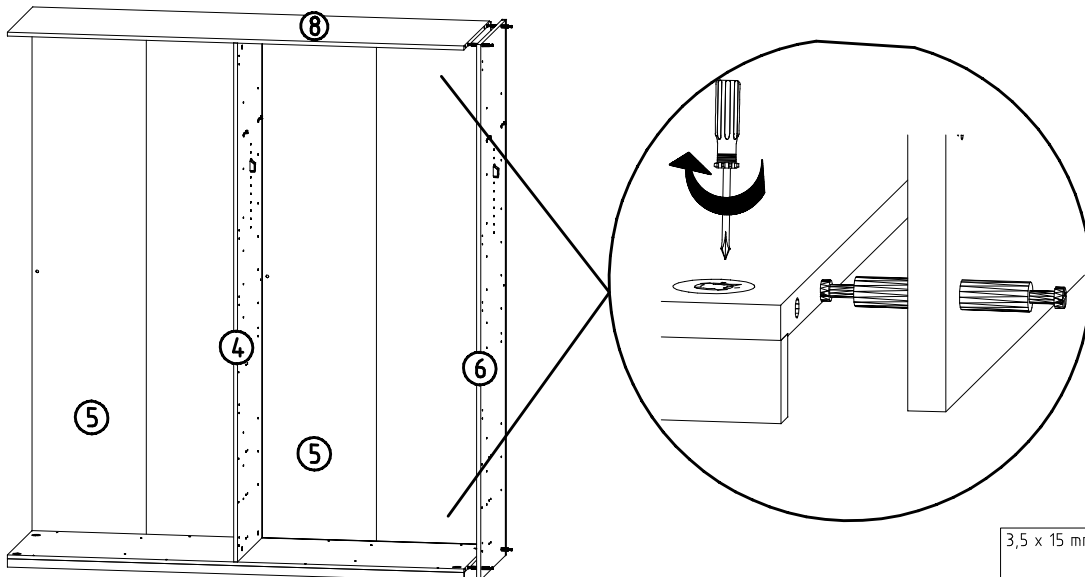
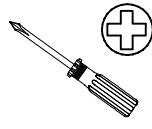

15

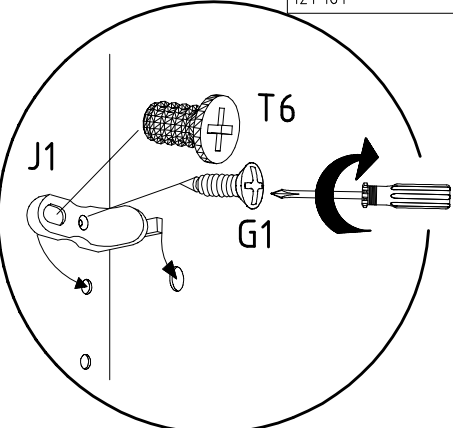
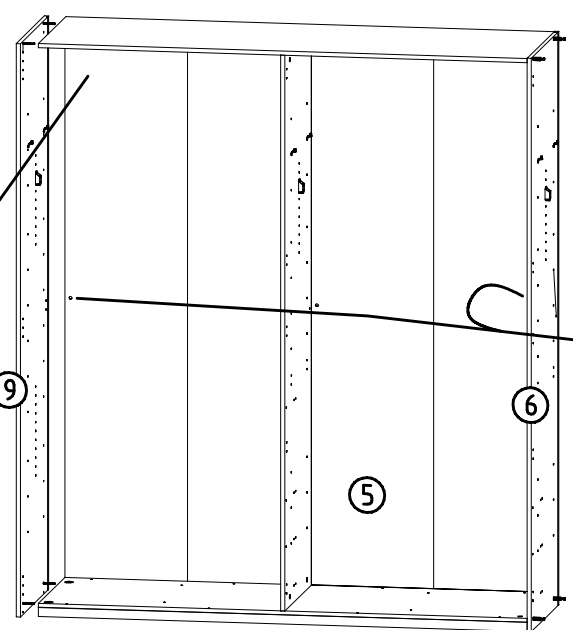
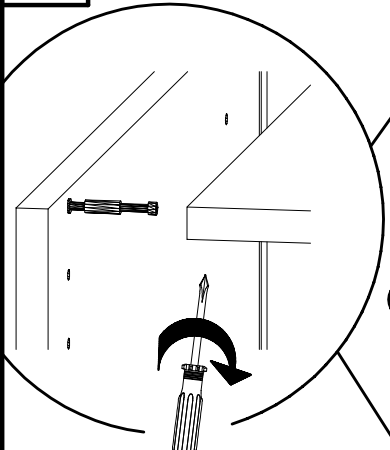

16

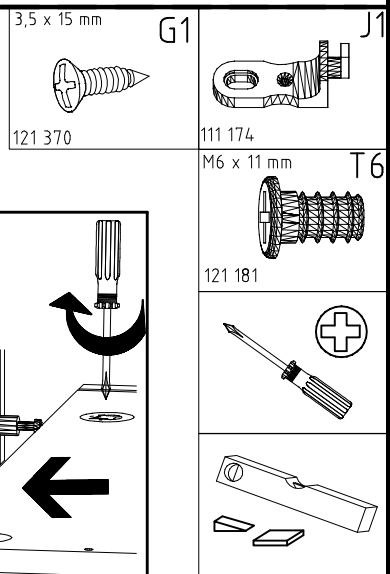
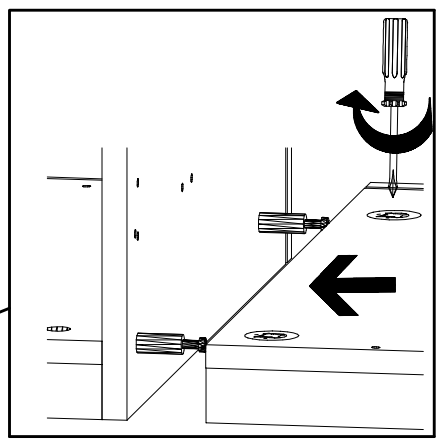
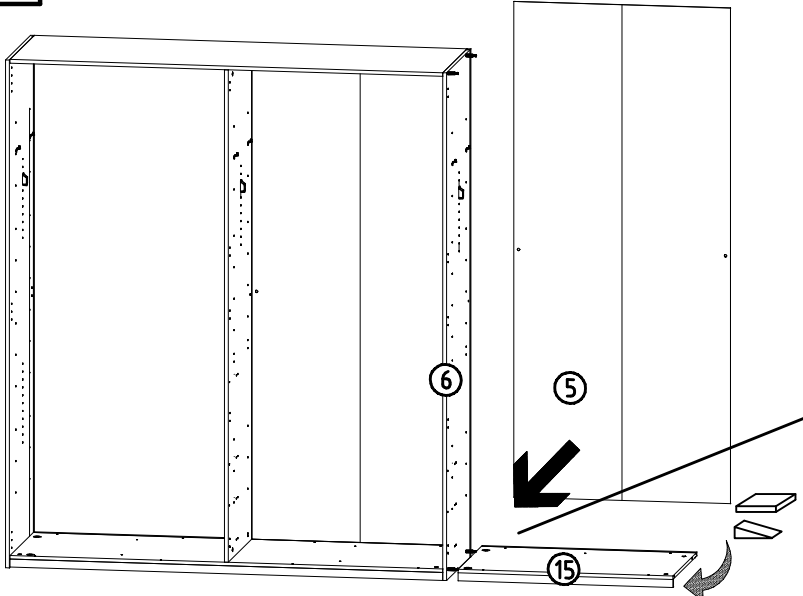

17

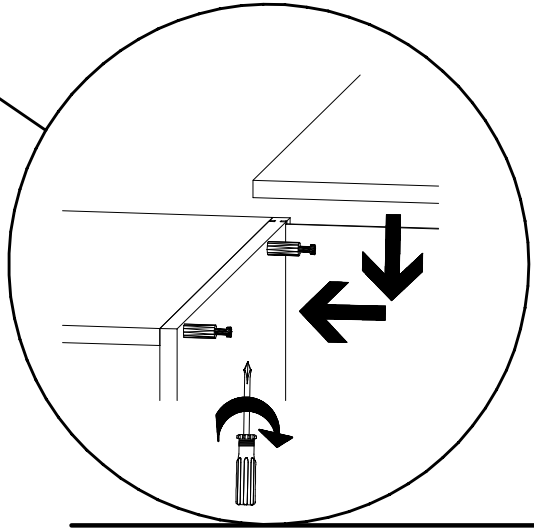
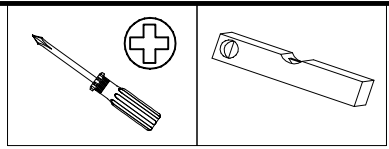
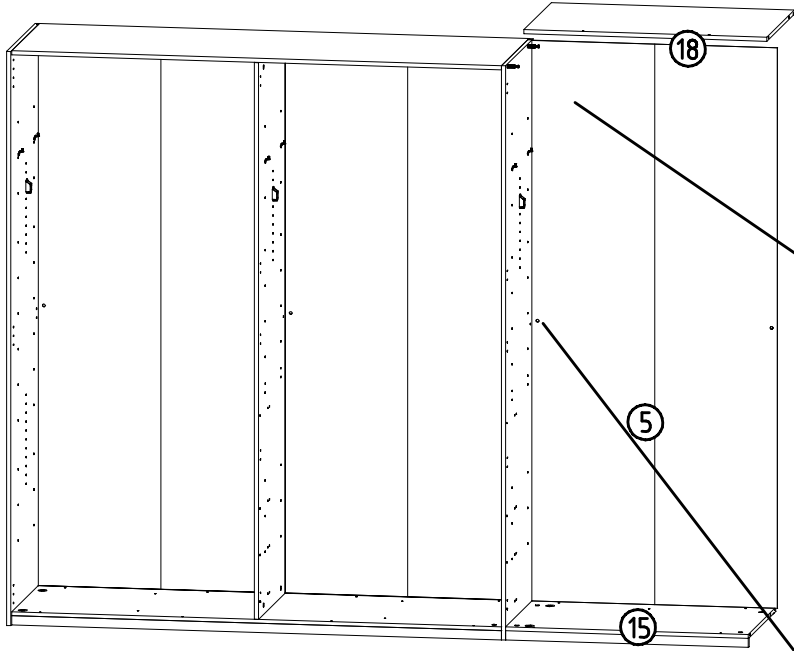

18

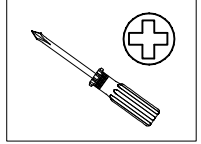
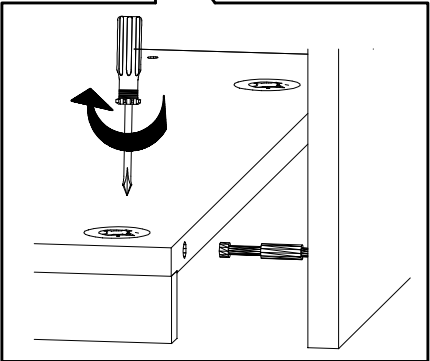
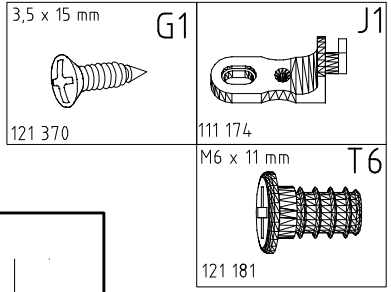
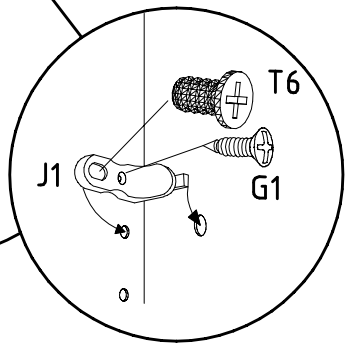
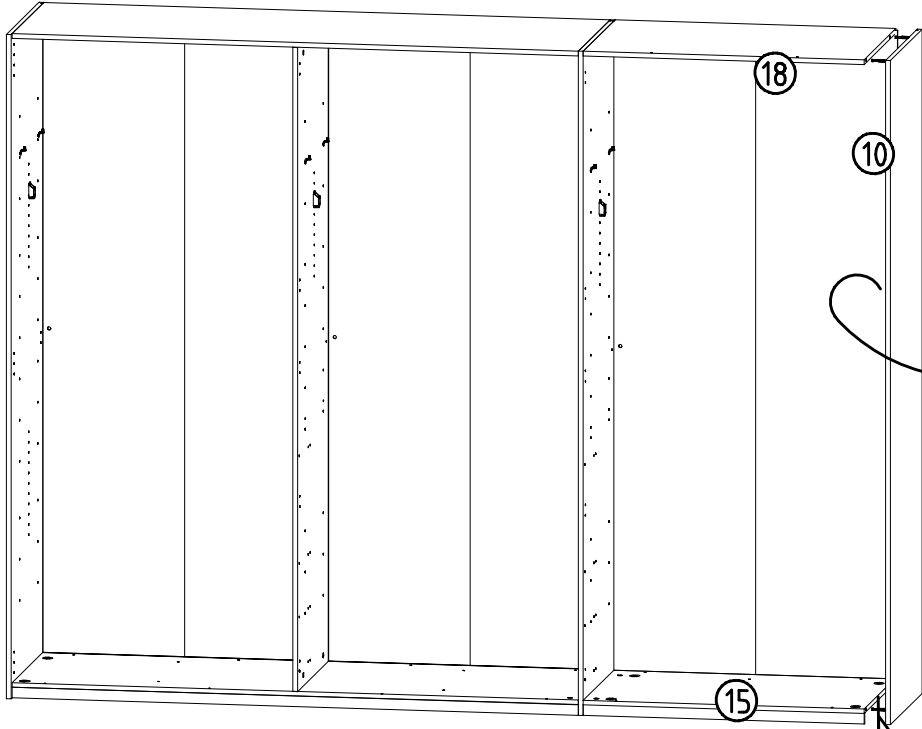

19

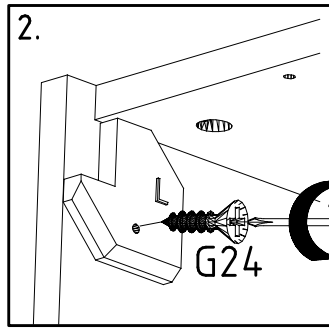
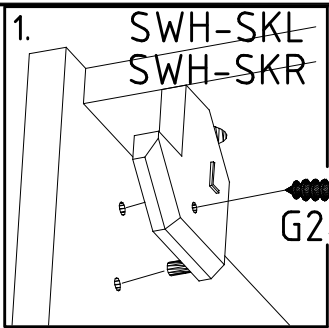

3,5 x 35 mm G14	M4 x 10 mm G43	M4 x 13 mm GH13
121 375	121 xxx	121 xxx

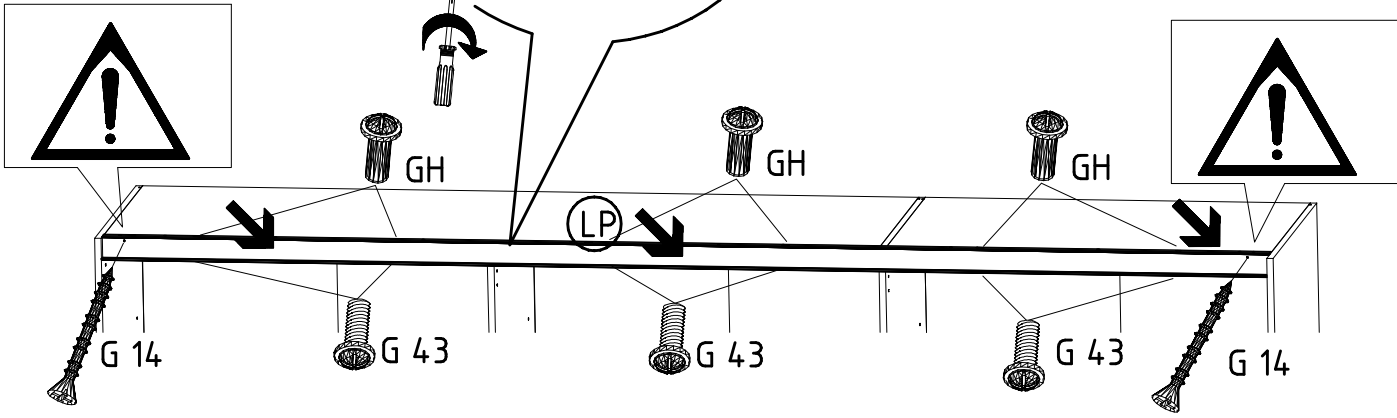
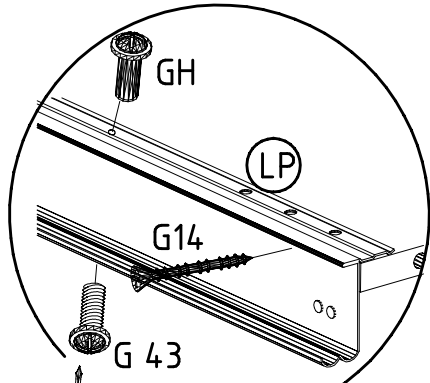
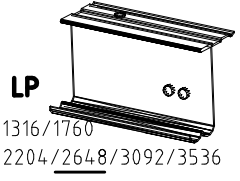
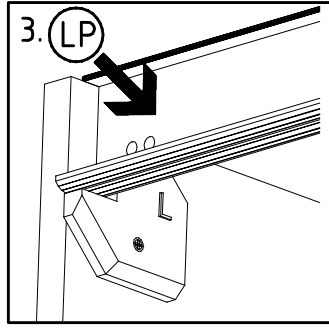

20

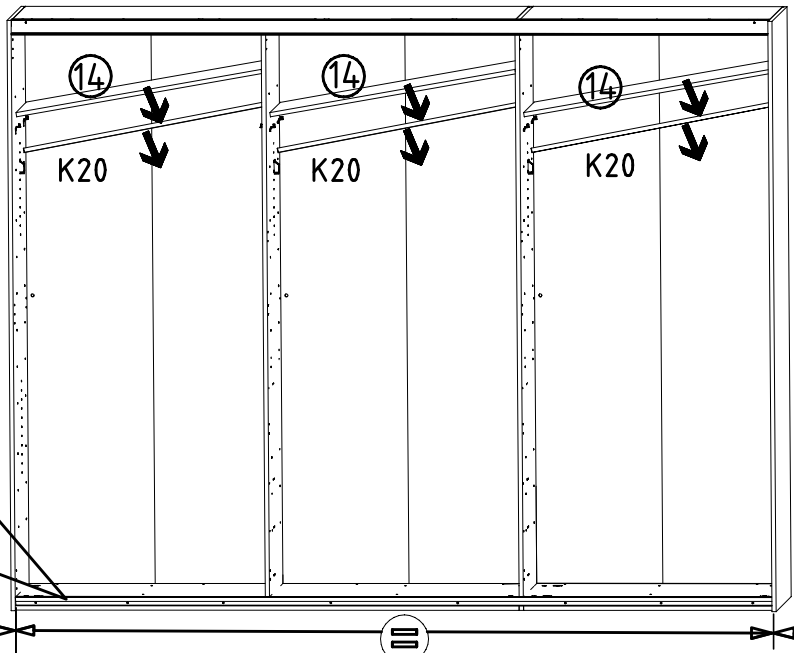

K20
870mm
112 402

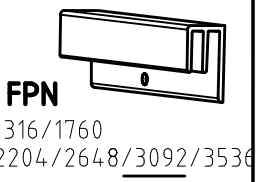
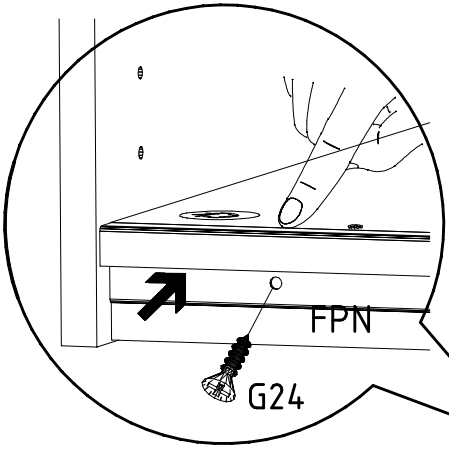

3,5 x 22 mm G24
121 004



21

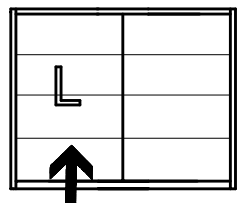
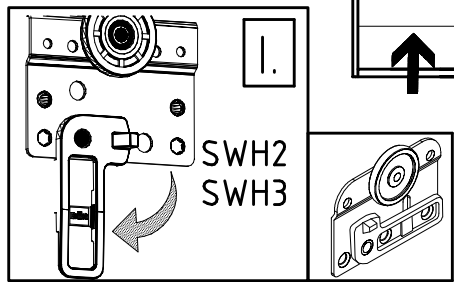

II.

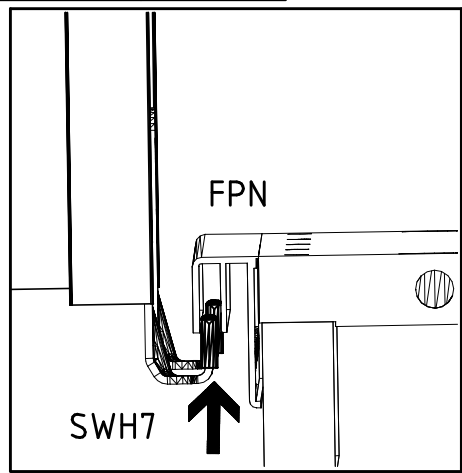

III.

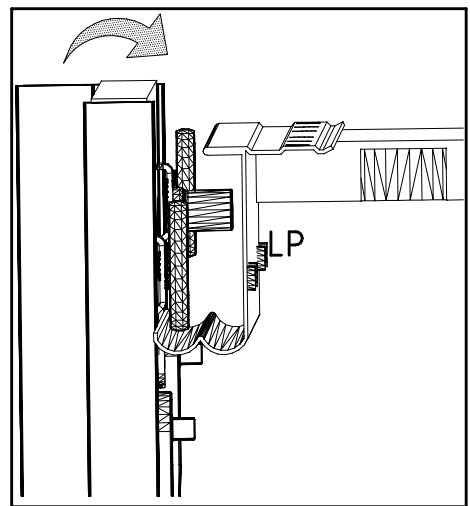

IV.

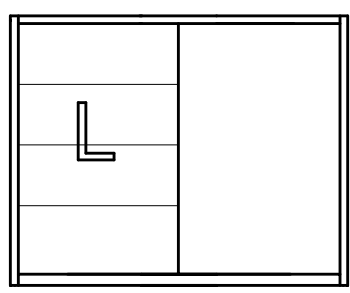
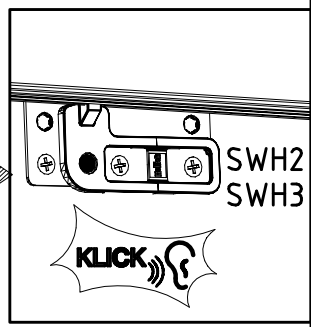
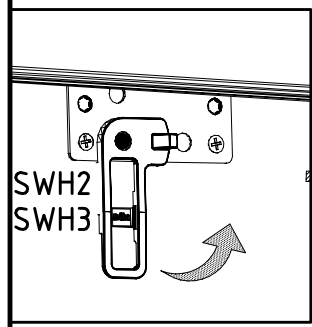

22

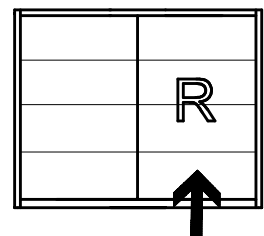

I.

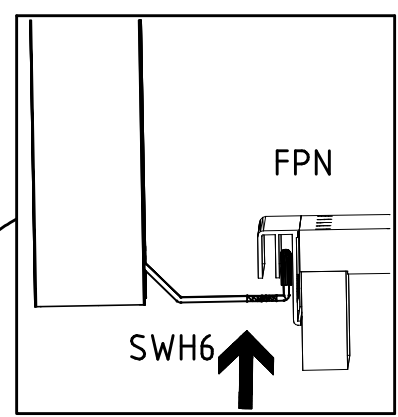
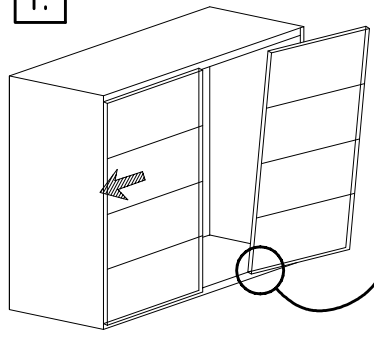

II.

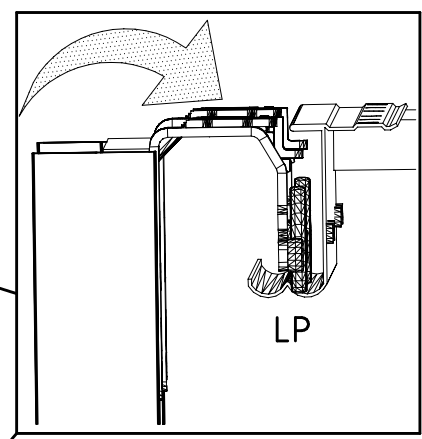
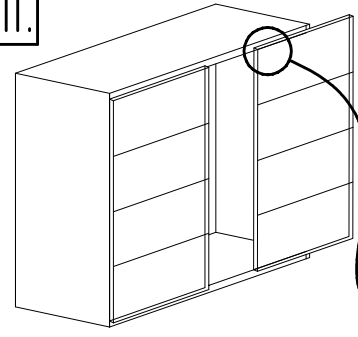

III.

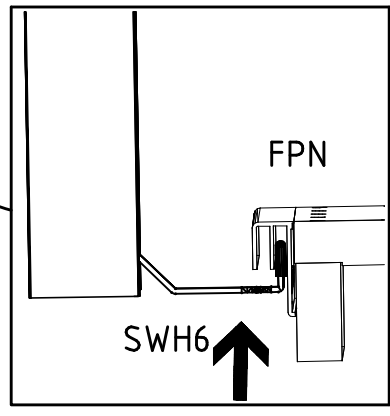
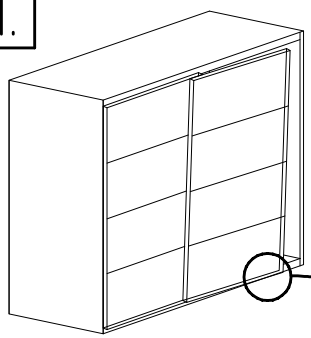

IV.

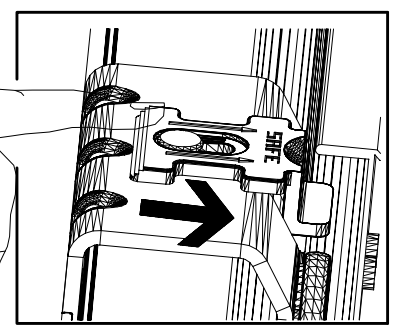
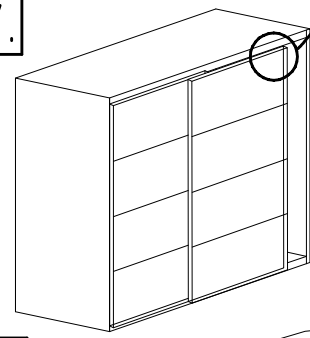

V.

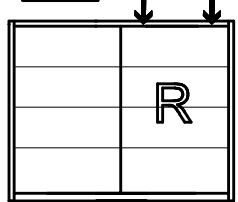

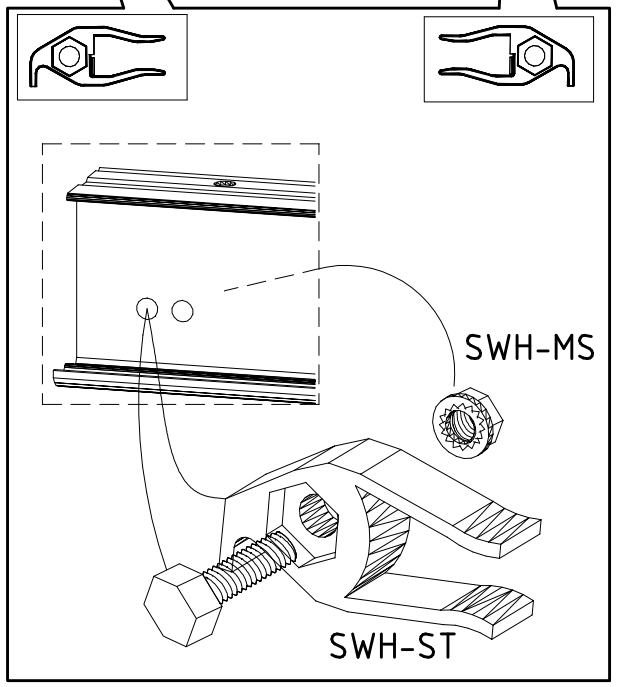
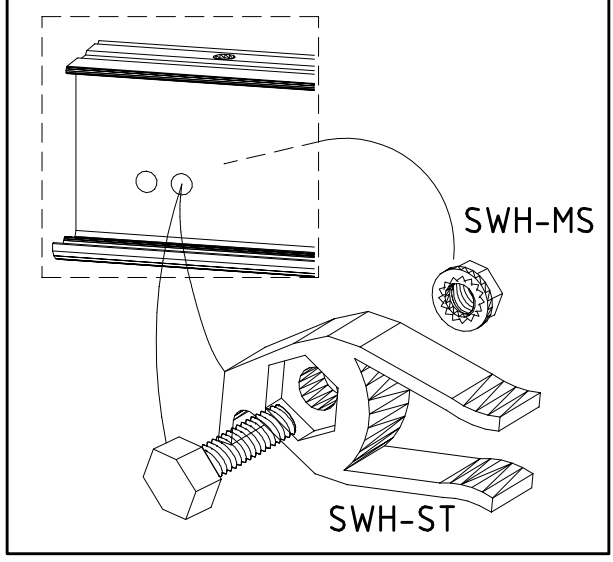
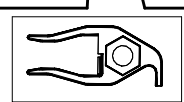
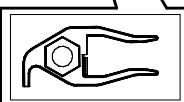
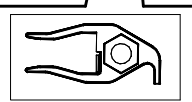
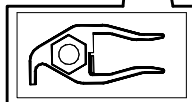
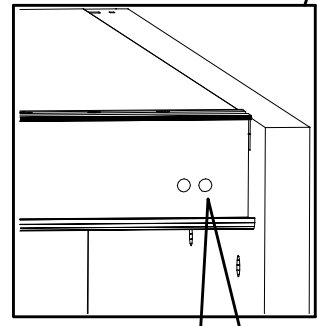
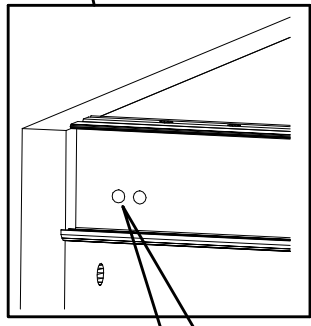
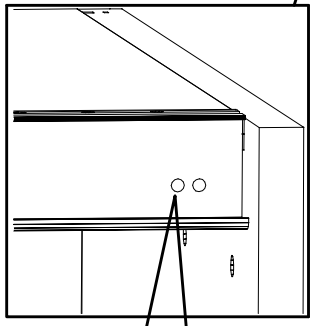
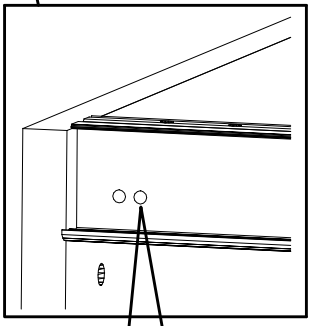
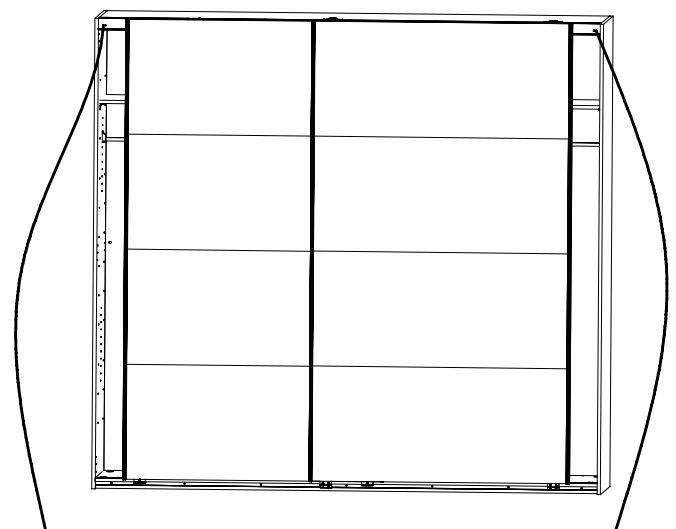
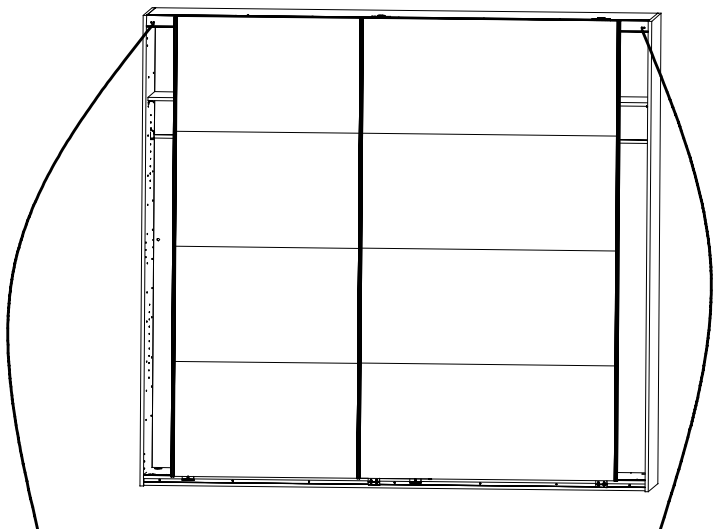
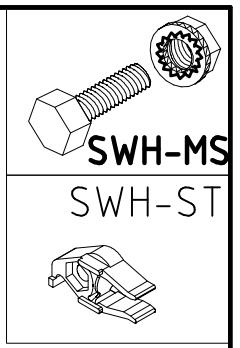
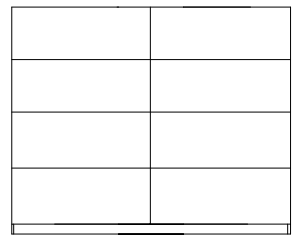
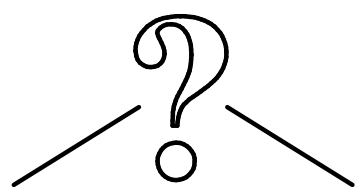
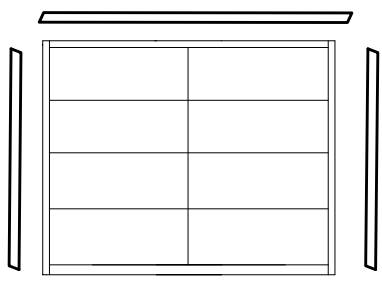

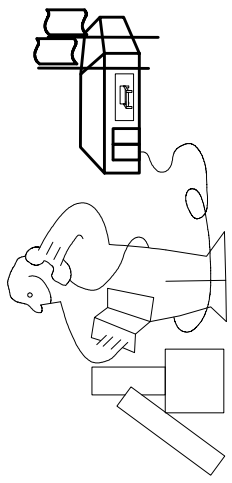
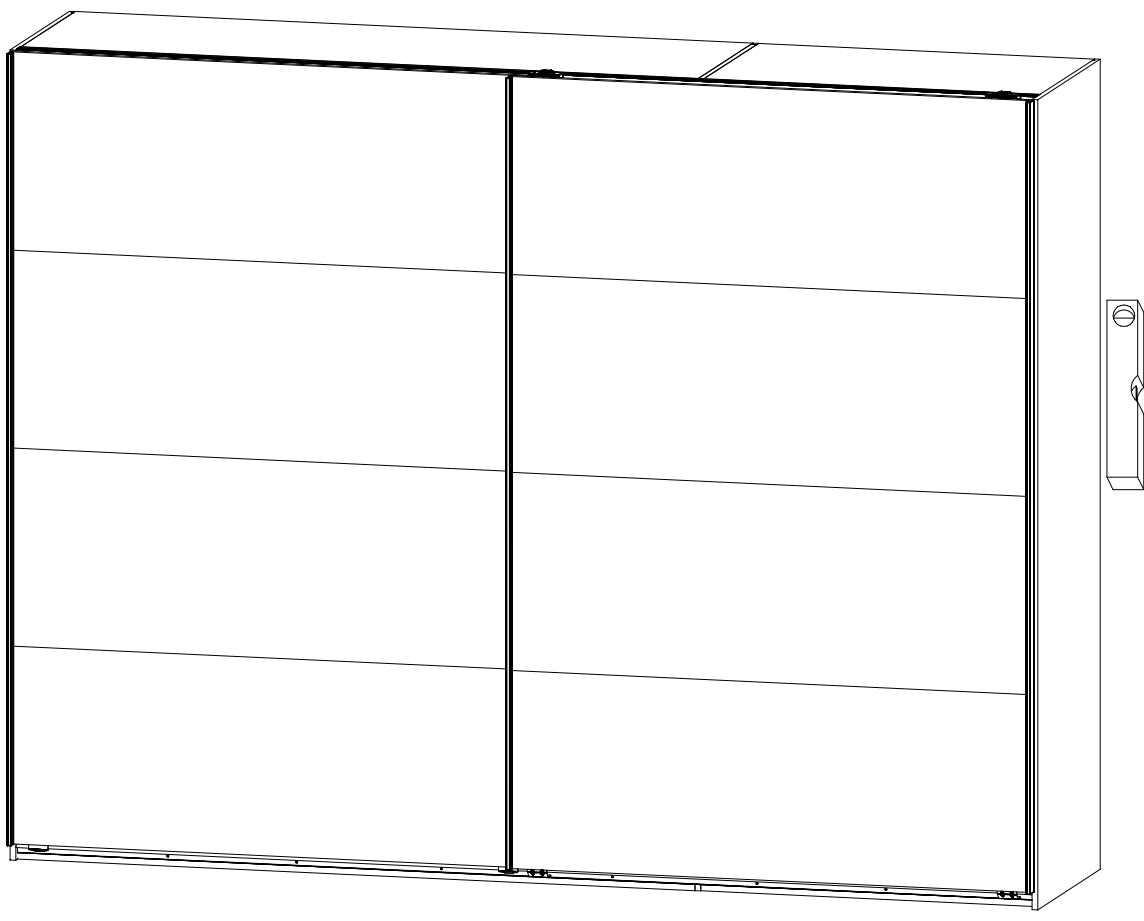
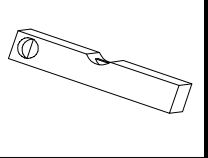

Modell/Model/Modèle

5.

Illustrations of a person reading a manual, a person using a pencil to mark a shelf, and a person using a screwdriver to assemble a shelf. Below these are several horizontal lines for notes.

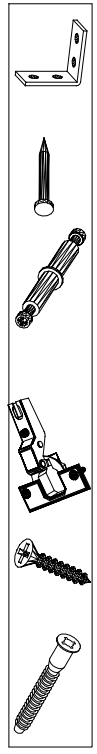

(121 370)	( G 1 )	(4x)

Änderungen die dem technischen Fortschritt geschuldet sind, behalten wir uns vor!  
 Bei nicht vorschriftsmäßiger und/ oder nicht fachmännischer Montage wird bei Personen- und/ oder Sachschäden keinerlei Haftung übernommen.

WIMEX Wohnbedarf/ Import Export Handels GmbH/ Postfach 1407/ 49112 Georgsmarienhütte/ Germany  
 Tel.:(+49) 054-01 8598 16/17 Fax.:(+49) 054-01 8598 33 Mail: service\_H@wimex-online.com

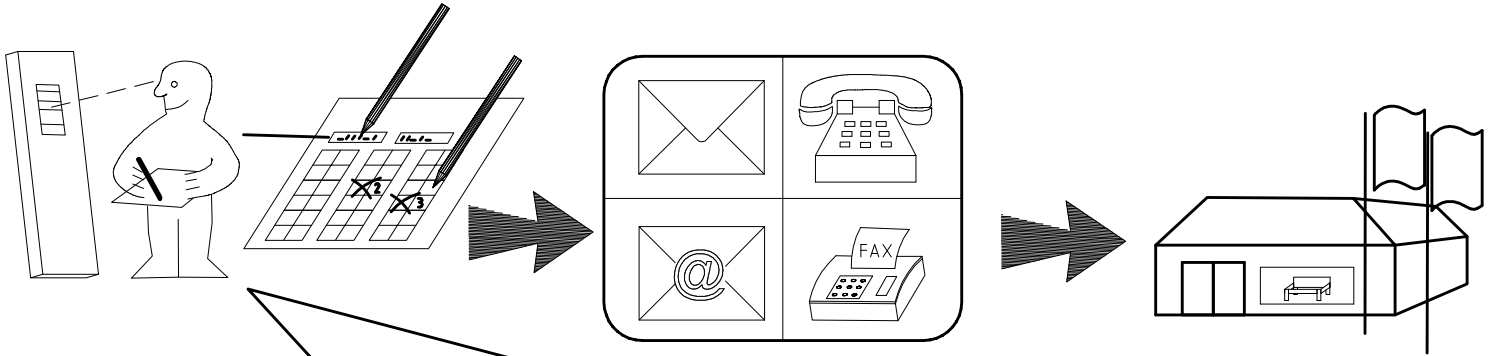
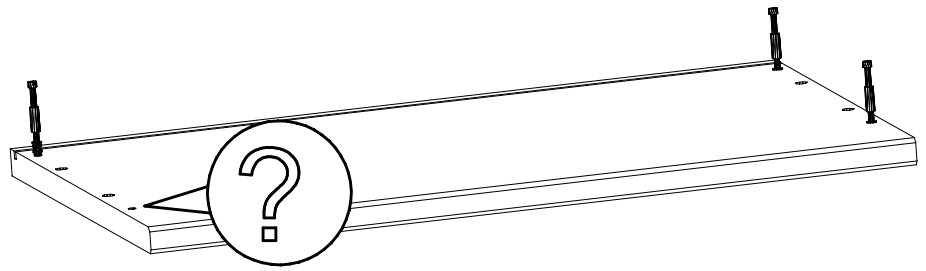
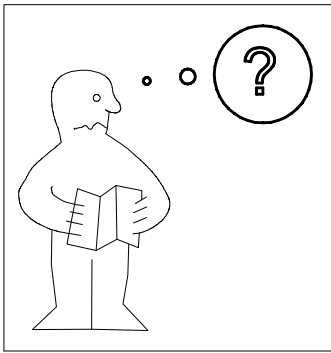

Auftrag/Order-No  
No. de Commande

Kunde/Customer  
Client

	<b>SWH1</b>
	<b>SWH2</b>
	<b>SWH3</b>
	<b>SWH 6</b>
	<b>SWH 7</b>
	<b>SP13</b> 4 X 13mm 121 122

	<b>SWH-D</b>
	<b>SWH-SKL</b>
	<b>SWH-SKR</b>
	<b>SWH-ST</b>
	<b>SWH-MS</b>
	<b>T2</b> 6,3 x 10,5 mm 111 030
	<b>G43</b> M4 x 10 mm 121 xxx

	<b>G1</b> 3,5 x 15 mm 121 370
	<b>G24</b> 3,5 x 22 mm 121 004
	<b>A</b> 111 102
	<b>L7</b> 111 610
	<b>H5</b> 114 183
	<b>G14</b> 3,5 x 35 mm 121 375
	<b>GH13</b> M4 x 13 mm 121 xxx

	<b>K1</b> 117 001
	<b>C</b> 111 103
	<b>J1</b> 111 174
	<b>T6</b> M6 x 11 mm 121 181
	<b>K20</b> 870mm 112 402
	<b>K21</b> 424mm 112 403
	<b>F3</b>

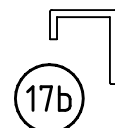
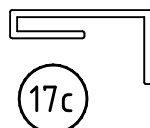
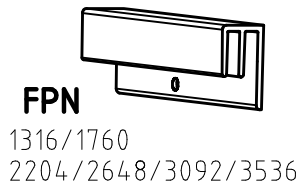
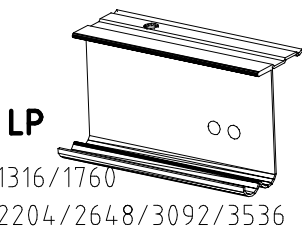

WIMEX Wohnbedarf / Import Export Handels GmbH / Postfach 14/07 / 49112 Georgsmarienhütte / Germany  
 Tel.: (+49) 054-01 8598 16/17 Fax.: (+49) 054-01 8598 33 Mail: info@wimex-wohnbearf.de

104P-Nr. / 104P-No.    150X-Nr. / 150X-No.    Auftrag/Order-No. / No. de Commande

**23203**    **30110XY**    104

Kunde    MAX MUSTERMANN  
Customer  
Client

Kommission / your order reference / votre reference

**3377 MINDEN**

---

Dekor / Decor    Decor / Modell / Model

**F99**    **SAMPLE**

F99842    SCHWEBETUERENSCHRANK 250 CM H 216CM  
PLANKENEICHE NB + RAU STEEL  
PLANKENEICHE NACHBILDUNG

202320301107241476000001

Paket / Package / Paquet

**414760**

SOCKEL

Paket 1 von 8    Colli Kommission 10

HSP-SMT BOD 50 TEXT/TEX SOCKEL 32 FRESH    TV / LF 104  
SO-BOD TEXT RASTEX/ ZNBOD D18MM TX KLSTA

Montage - Anleitung    Laenge ..... 520,0    OBEREN  
KS-64    Breite ..... 568,0    OBEREN

**SOCKEL32 KLEB**

En cas de dommage, veuillez retourner le colis avec le carton. En cas de dommage, veuillez retourner le colis avec le carton.



OBEREN 5 30/19 HAUT 23.08.19 OBEREN 1 1. ABOVE OBEREN



**WIMEX Wohnbedarf**  
Import Export Handelsges mbH & Co. KG  
Werner-von-Siemens-Str. 35  
D-49124 Georgsmarienhütte - Germany

**SAMPLE**    **23.08.19**  
Modellname    Produktionsdatum  
Model    Date of manufacture

