

# SILIAS T12

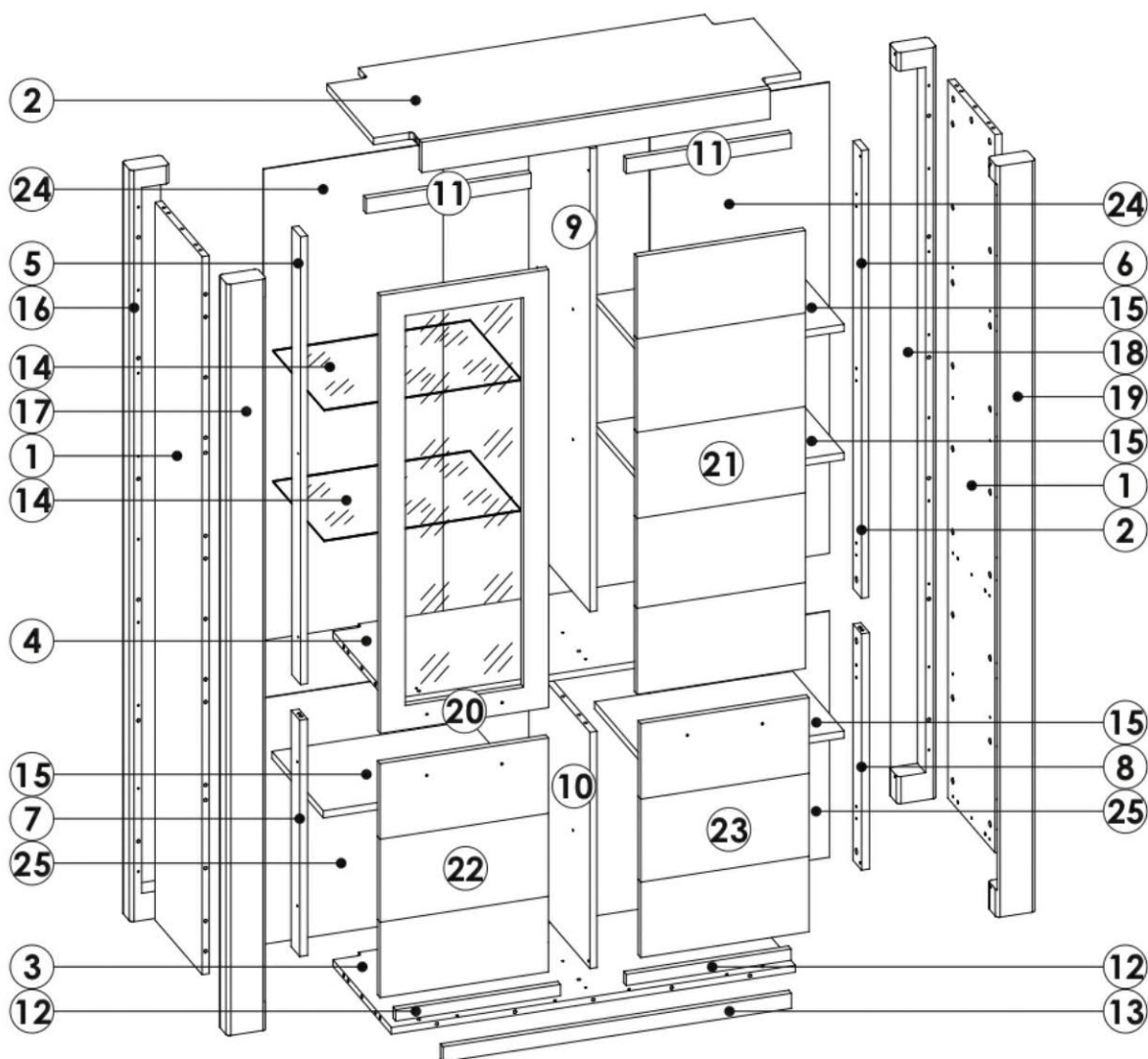











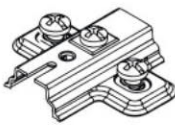
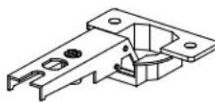

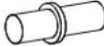
1	1902	331	19	x2	1/3
2	1090	455	80	x1	2/3
3	1032	428	19	x1	2/3
4	1032	428	19	x1	2/3
5	1186	60	20	x1	2/3
6	1186	60	20	x1	2/3
7	626	60	20	x1	2/3
8	626	60	20	x1	2/3
9	1227	428	19	x1	3/3
10	626	428	19	x1	2/3

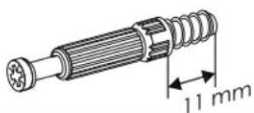
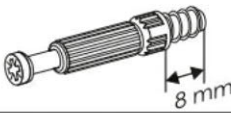
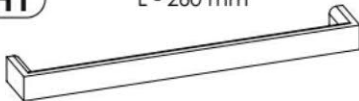
11	421	45	19	x2	2/3
12	421	30	19	x2	2/3
13	890	40	18	x1	2/3
14	504	350	6	x2	2/3
15	506	360	19	x4	2/3
16	1990	100	60	x1	1/3
17	1990	100	60	x1	1/3
18	1990	100	60	x1	1/3
19	1990	100	60	x1	1/3
20	1160	430	22	x1	3/3

21	1160	430	58	x1	3/3
22	610	430	48	x1	3/3
23	610	430	48	x1	3/3
24	1251	459	3	x2	3/3
25	653	459	3	x2	3/3

# SILIAS T12

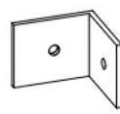
<b>A1</b> 8 x 30 mm x42 	<b>A2</b> 8 x 50 mm x4 	<b>B0</b> x10 
<b>B1</b> x10 	<b>C2</b> 5 x 13 mm x38 	<b>D1</b> x16 
<b>D2</b> x8 	<b>E1</b> 15 x 12 mm x89 	<b>F1</b> 6 x 34 mm x75 
<b>F2</b> 6 x 34 mm x14 	<b>H1</b> L - 260 mm x4 	<b>I1</b> 3 x 16 mm x96 
<b>M4</b> M4 x 22 mm x8 	<b>N8</b> 4 x 16 mm x10 	<b>N14</b> 4 x 30 mm x4 
<b>N15</b> 4 x 35 mm x4 	<b>R0</b> x28 	<b>W1</b> x14 
<b>S</b> x89 