



**(D)** Videounterstützte Montageanleitung

**(TR)** Video destekli kurulum talimatları

**(RU)** инструкция по монтажу с помощью видеосигнала

**(RO)** Instrucțiuni de instalare acceptate video

**(GB)** Video-assisted assembly instructions

**(IT)** Istruzioni di montaggio video-assistite

**(CZ)** Instalační pokyny podporované videem

**(PL)** Instrukcje montażu wspomagane sygnałem wizyjnym

**(FR)** Instructions de montage assistées par vidéo

**(NL)** Video-ondersteunde montage-instructies

**(HU)** Video-támogatott telepítési utasítások

**(SK)** Inštačné pokyny podporované videom

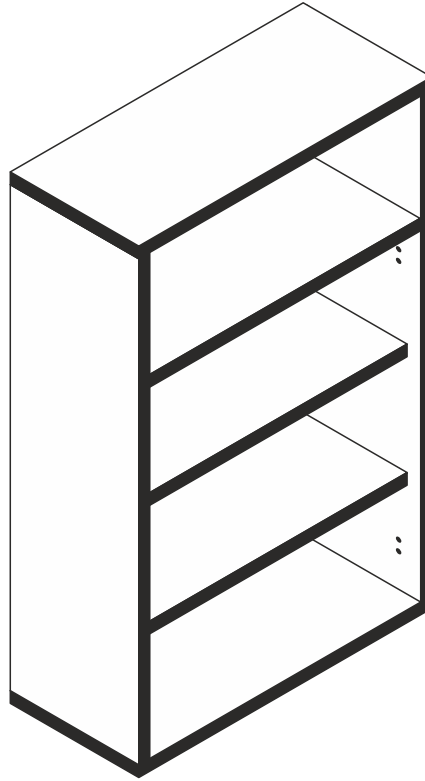
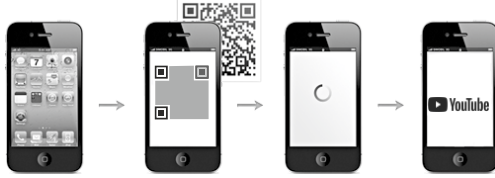

Art.Nr. : **0200\_81x145**

# Aktenregal





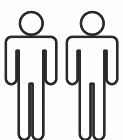
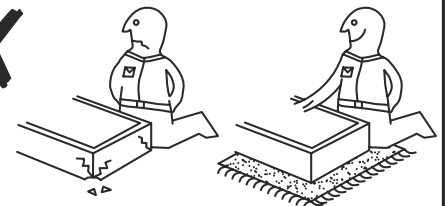
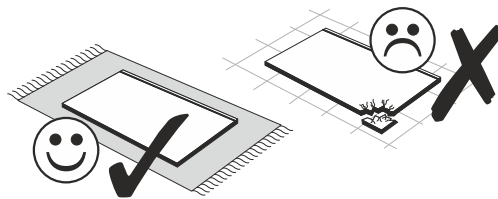
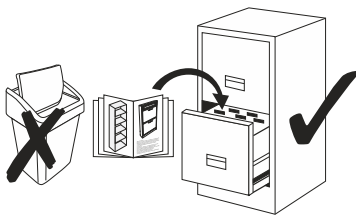
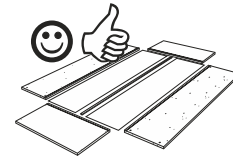
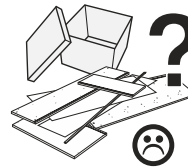
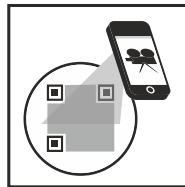
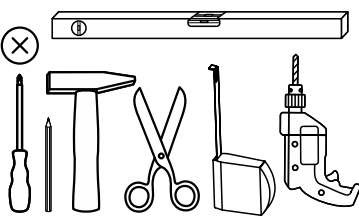

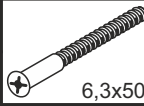

REPC-Nr.:

Service • Assistenza • Dienstverlening • Serwis  
Servis • Szerviz • Сервисная служба

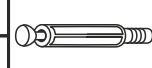

Colli 1/1: 1 2 3 4 5 6 7 8 Beutel 1/1

# Beutel 1/1

1-10 4x  6,3x50	1-30 8x  3x16	1-80 8x  3,5x13	1-90 12x  3,5x20	2-10 8x 	2-20 8x 
2-162 8x 	2-170 6x 	5-185 6x 	8-80 1x 		

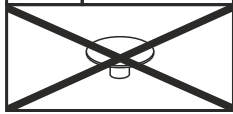

Artikel enthält keine Abdeckkappen für Excenter (Teil 2-10)!

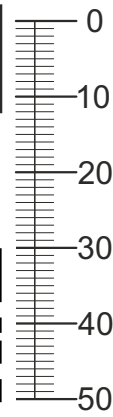
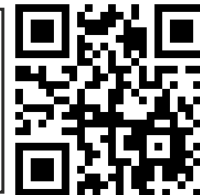
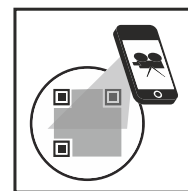

# Colli 1/1

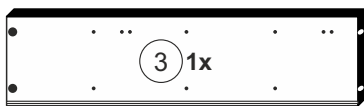

1394 x 354

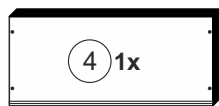

807 x 354

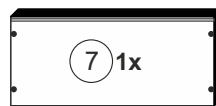

807 x 354

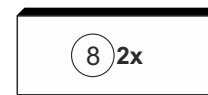

768 x 313

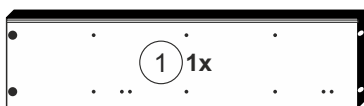

1394 x 354

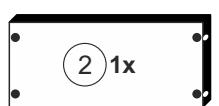

768 x 336



1406 x 390



500 x 50

**1**

2-10		2x
2-20		2x
2-162		4x

1

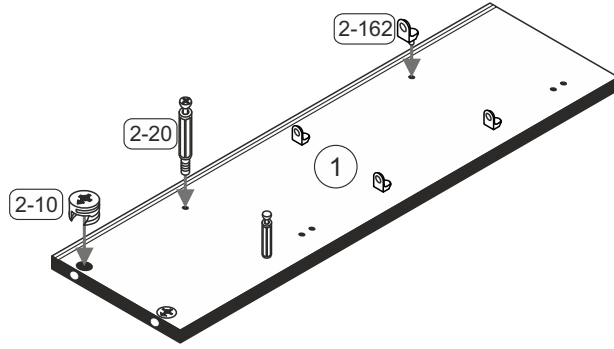

**2**

2-10		2x
2-20		2x
2-162		4x

3

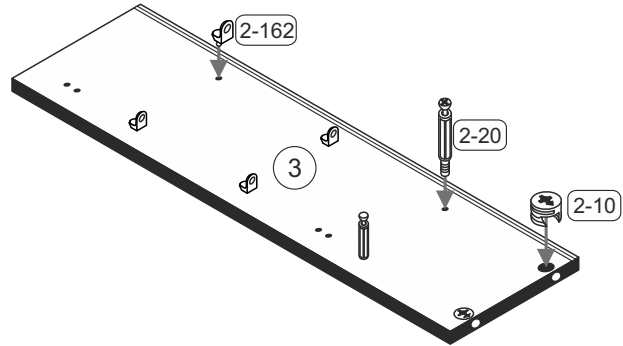

**3**

2-10		4x
------	--	----

2

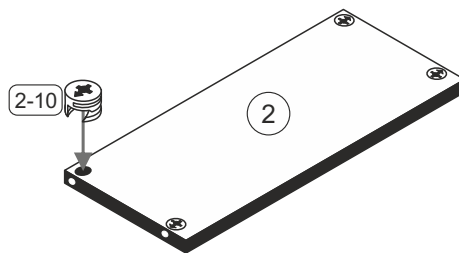

**4**

2-20		4x
------	--	----

4

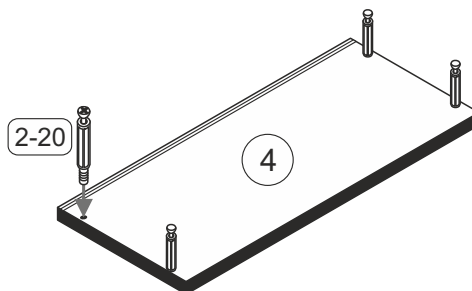

5

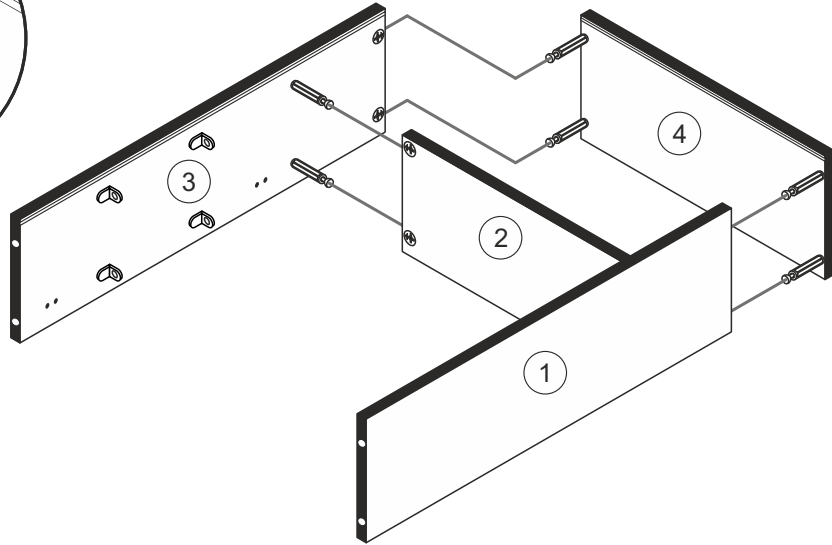
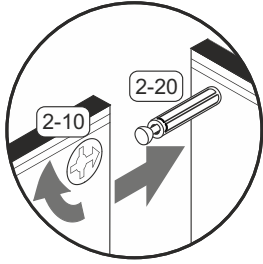

6

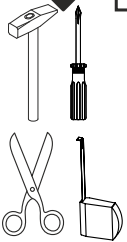

1-10		1-30		1-90		2-170		5-185	
4x		8x		12x		6x		6x	

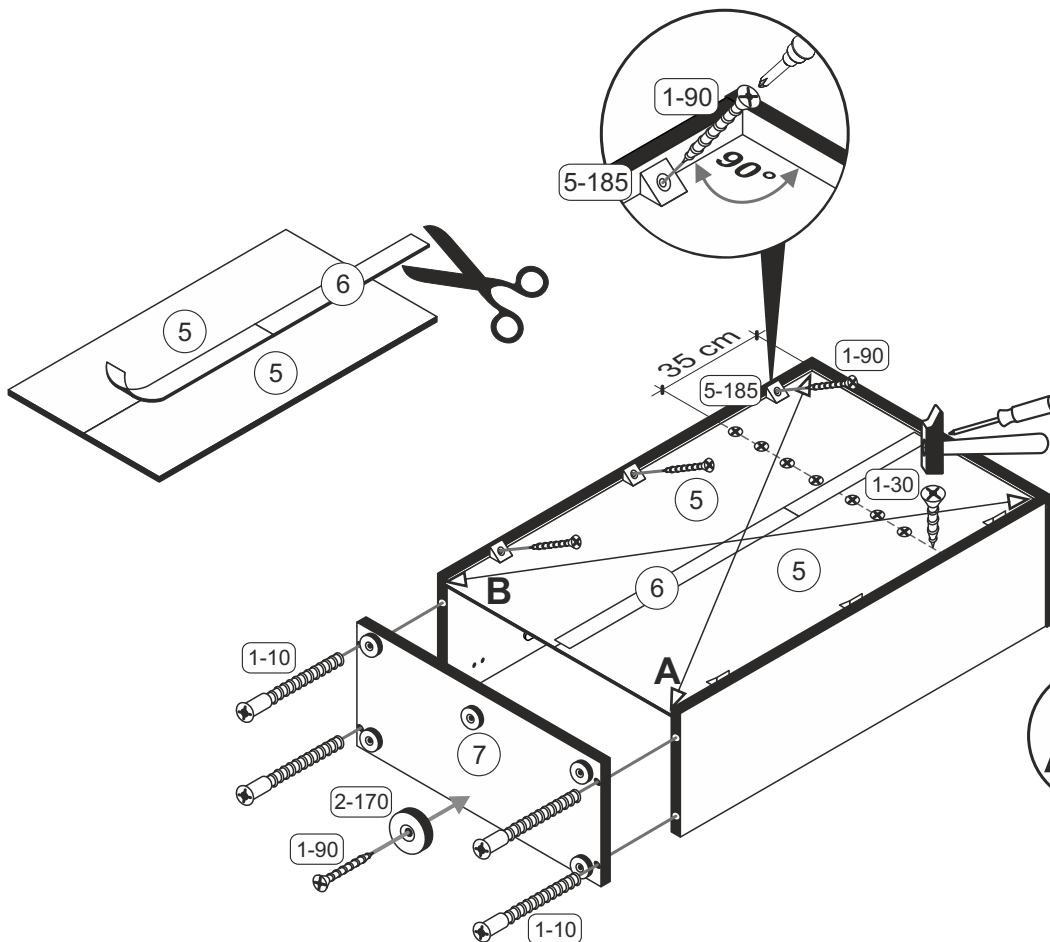



1-80		8-80	
8x	3,5x13	1x	

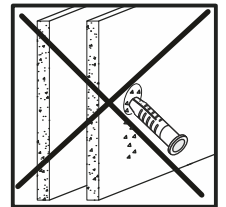
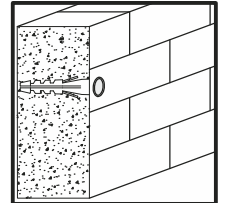
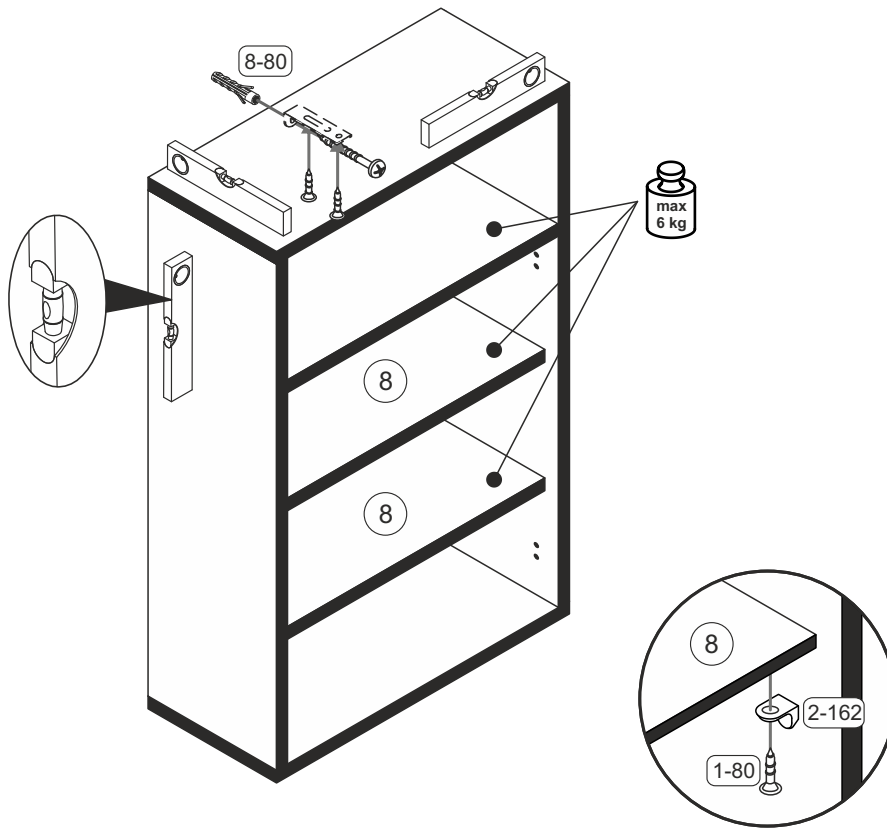
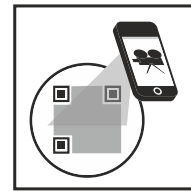

<b>Achtung • Attention • Attenzione • Opgelet • Uwaga • Pozor • Figyelem • Atenție • Dikkat • Внимание</b>	
(D)	Wandbefestigung dient als Kippschutz - unbedingt anbringen! Bei einigen Wandtypen kann ein Spezialdübel erforderlich sein!
(GB)	The wall fastening serves to prevent tipping - be absolutely sure to mount it! For certain wall types, a special wall plug may be necessary!
(FR)	La fixation murale sert de protection contre le basculement – à installer impérativement ! Pour certains types de murs il faut des chevilles spéciales !
(TR)	Duvardaki sabitleme, devrilmeye karşı bir emniyet tedbiridir ve mutlaka monte edilmelidir! Bazı duvar tiplerinde bunun için özel bir dübel gerekli olabilir!
(IT)	Il fissaggio alla parete serve da protezione anti-ribaltamento – attaccarla assolutamente! Per alcune strutture di parete può essere necessario un tassello speciale!
(NL)	Bevestiging aan de muur dient als kantelbescherming – zeker en vast bevestigen! Bij enkele muurtypes is een speciale plug misschien vereist!
(RU)	Обязательно установите крепление на стене во избежание опрокидывания! Для некоторых типов стен может потребоваться специальный дюбель!
(CZ)	Montáž na stěnu slouží jako ochrana proti převrnutí – bezpodmínečně umístěte! U některých typů stěn může být zapotřebí speciální hmoždinka!
(HU)	A terméket a falhoz kel rögzíteni, különben az felborulhat! Egyes faltípusoknál speciális tiplit kell használni!
(RO)	Sistemul de fixare la perete servește ca protecție la răsturnare - de montat obligatoriu! Pentru unele tipuri de pereți este posibil să fie necesar un diblu special!
(PL)	Mocowanie do ściany jest jednocześnie zabezpieczeniem przed przewróceniem – koniecznie zamontować! Do niektórych rodzajów ścian konieczne zastosować specjalne kołki mocujące.
(SK)	Upevnenie na stenu slúži ako ochrana proti prevráteniu – bezpodmienečne použite! Pre niektoré druhy stien môže byť potrebná špeciálna hmoždinka!