

COCO V
8100/2503
2501/8300
8100/3300
3100/8300

- | | | | |
|-----------|--|-----------|---|
| D | MONTAGEANLEITUNG
BEDIENUNGSANLEITUNG | GB | ASSEMBLY INSTRUCTIONS
INSTRUCTION MANUAL |
| NL | HANDLEIDING VOOR DE MONTAGE
GEBRUIKSAANWIJZING | PL | INSTRUKCJA MONTAŻU
INSTRUKCJA OBSŁUGI |
| TR | MONTAJ TALIMATI
KULLANIM KLAVUZU | RU | ИНСТРУКЦИЯ ПО МОНТАЖУ
ИНСТРУКЦИЯ ПО ЭКСПЛУАТАЦИИ |
| RO | INSTRUCȚIUNI DE INSTALARE
INSTRUCȚIUNI DE UTILIZARE | IT | ISTRUZIONI DI MONTAGGIO
MANUALE DI ISTRUZIONI |
| FR | NOTICE DE MONTAGE
MANUEL INSTRUCTIONS | SK | MONTÁŽNY NÁVOD
NÁVOD NA POUŽITIE |
| HU | KÖZGYŰLÉS UTASÍTÁSOK
KEZELÉSI UTASÍTÁS | CZ | MONTÁŽNÍ NÁVOD
NÁVOD K POUŽITÍ |
| SI | NAVODILA ZA MONTAŽO
NAVODILA ZA UPORABO | PT | INSTRUÇÕES DE MONTAGEM
MANUAL DO USUÁRIO |
| ES | INSTRUCCIONES DE MONTAJE
MANUAL DEL USUARIO | HR | UPUTE ZA MONTAŽU
UPUTE ZA UPOTREBU |

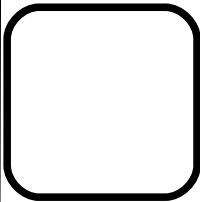

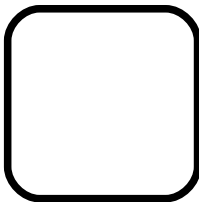

0037

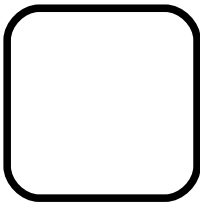
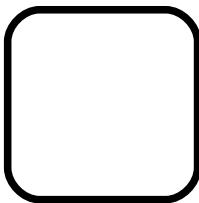
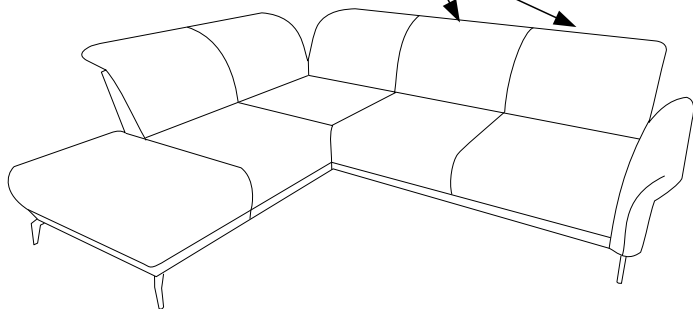
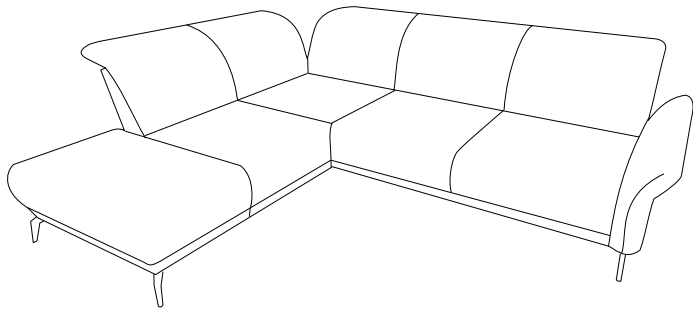
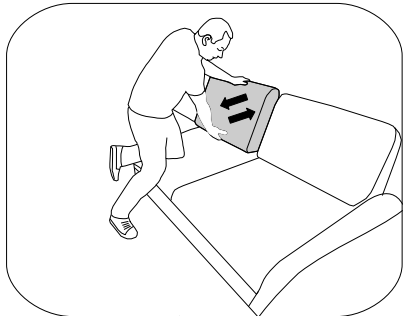

0037

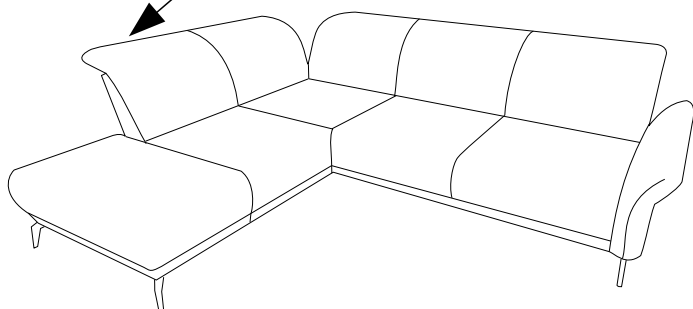
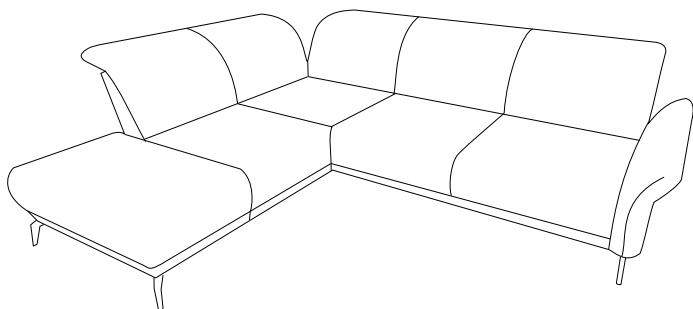
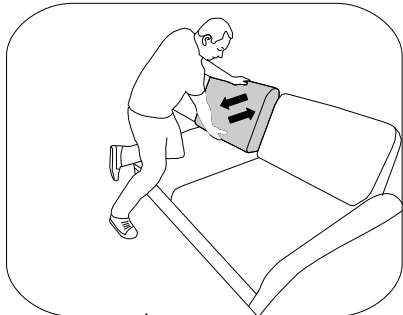

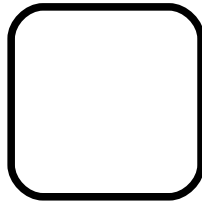
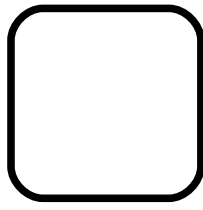

0064

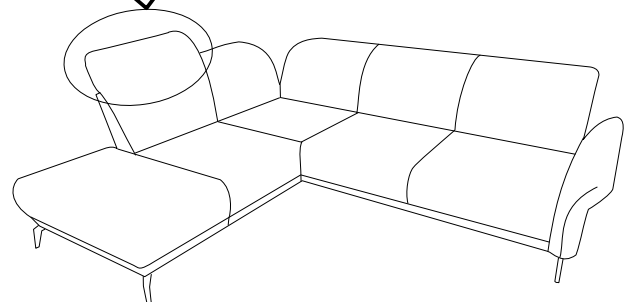
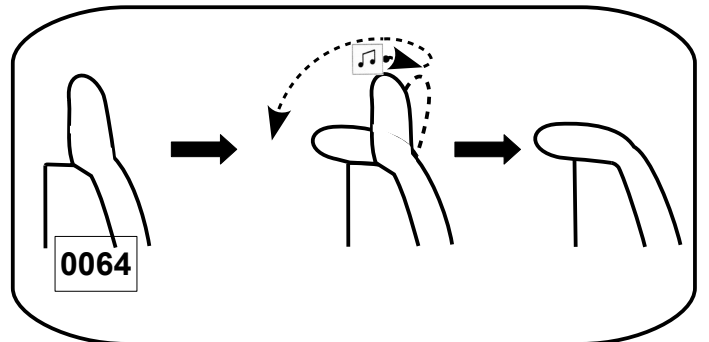
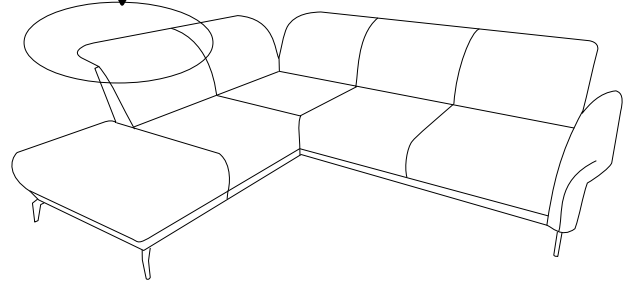
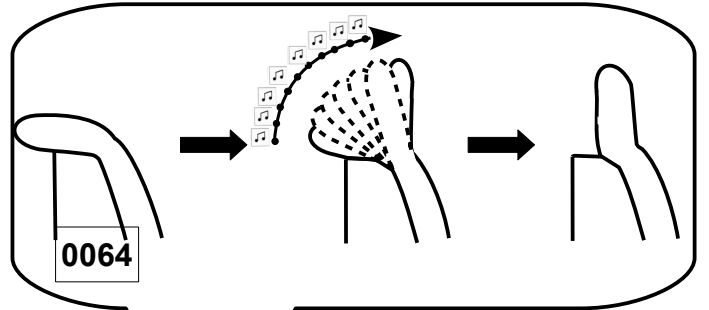
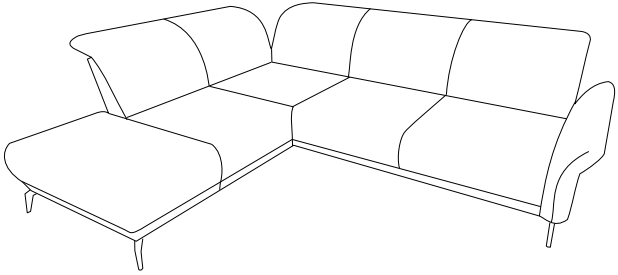

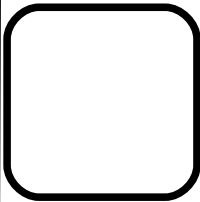
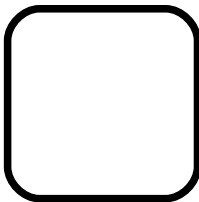

0090

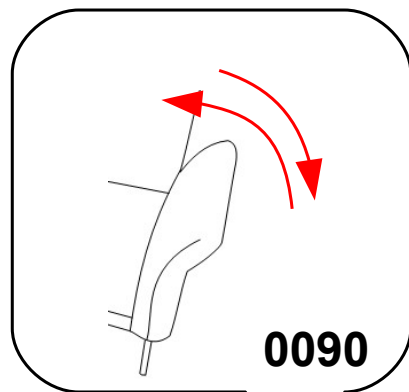

0090

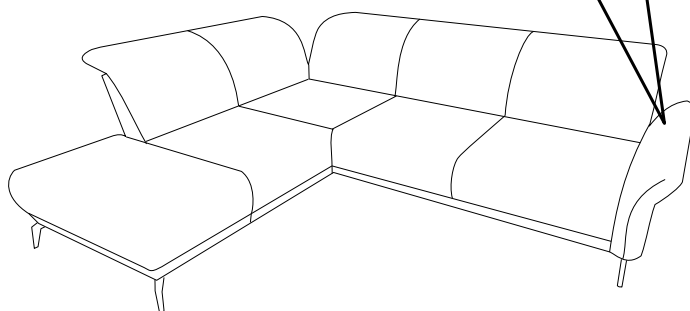
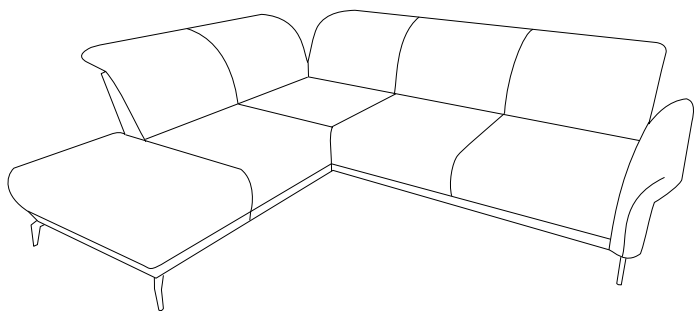



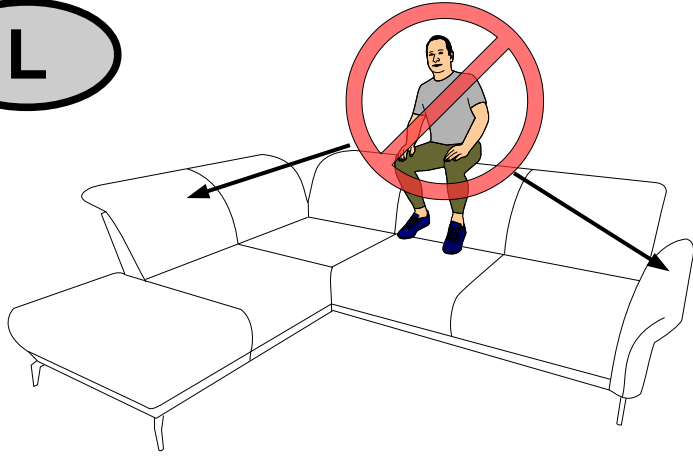

L

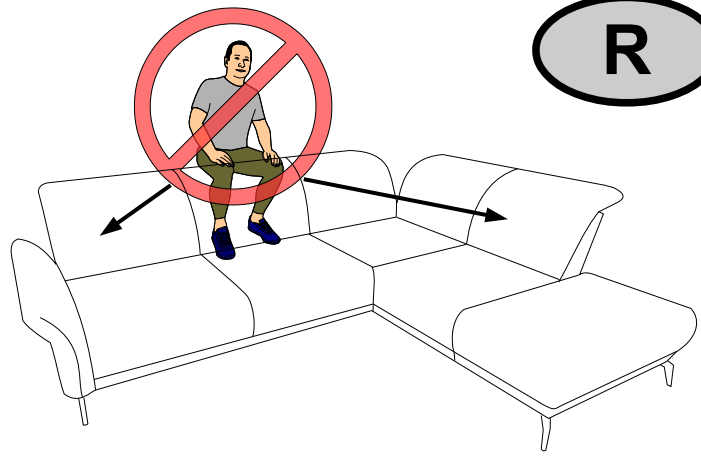



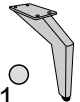

R

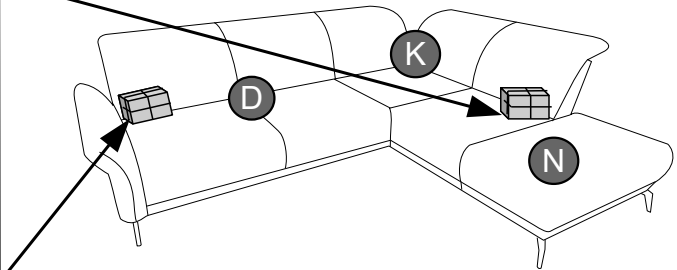
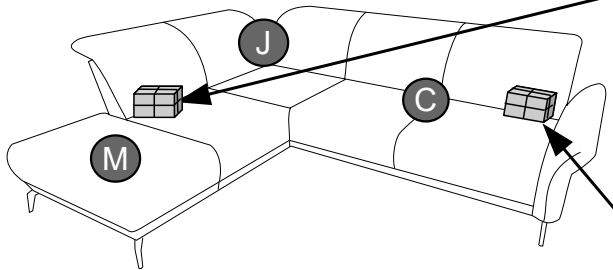

g H-150  X3	v H-150  X1	i L-4  X1	s H-150  s ₁ X3	q M6*25 [mm]  X12
---	---	---	--	---

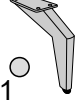

g H-150  X1	i L-5  X1	s H-150  s ₁ X2	q M6*25  X8
---	---	---	---

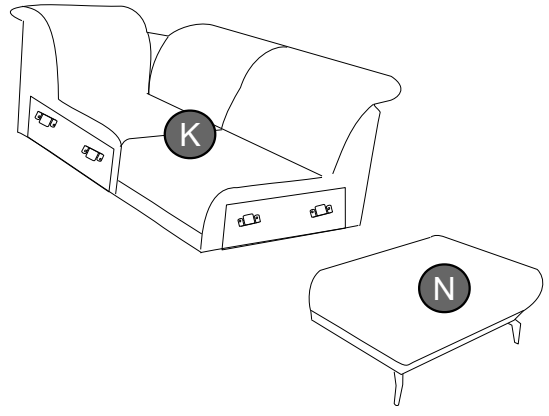
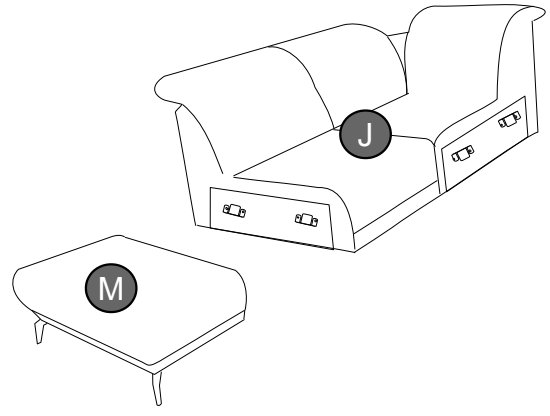
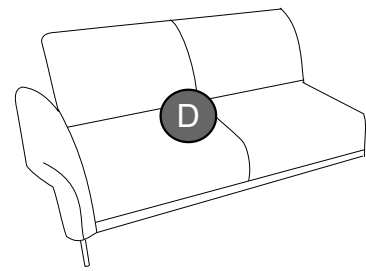
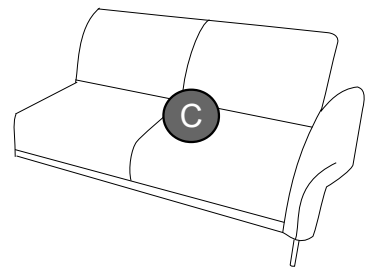

g H- 150



X4

v H- 150



X1

i L- 4



X1

s H- 150

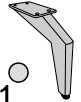

s₁

X5

q M6*25



X20

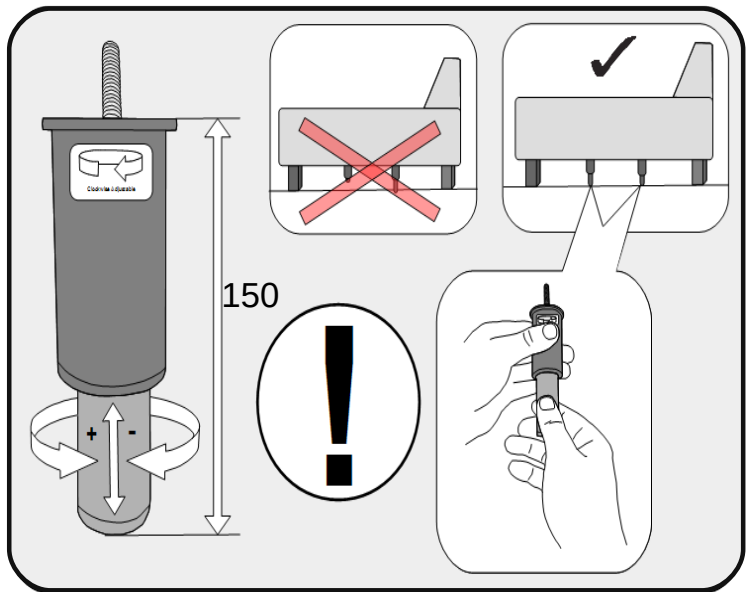
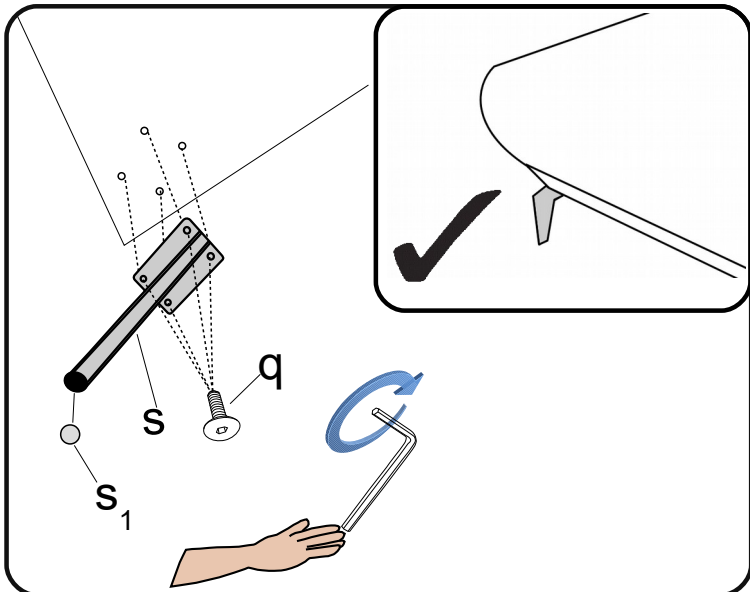
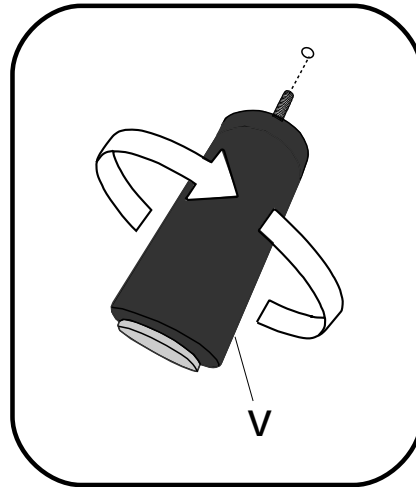
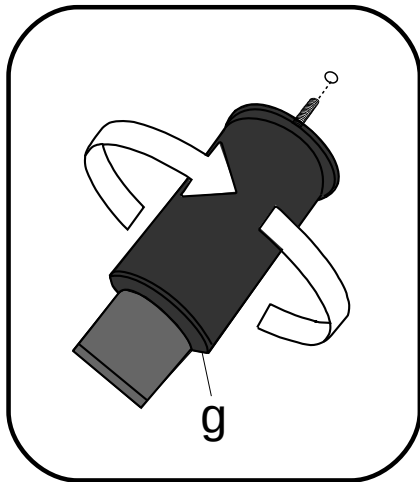
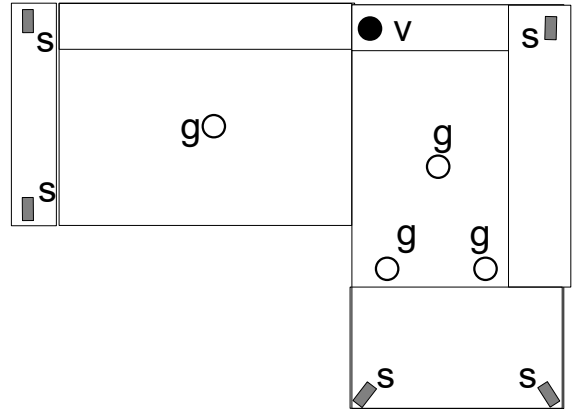
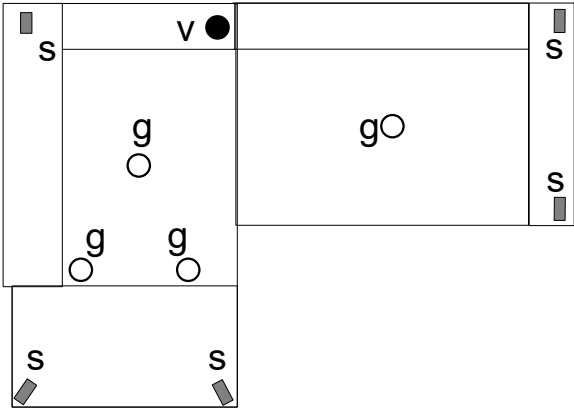
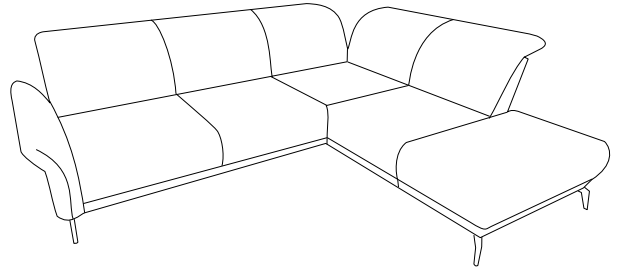
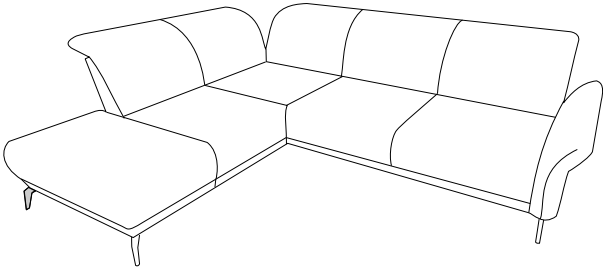

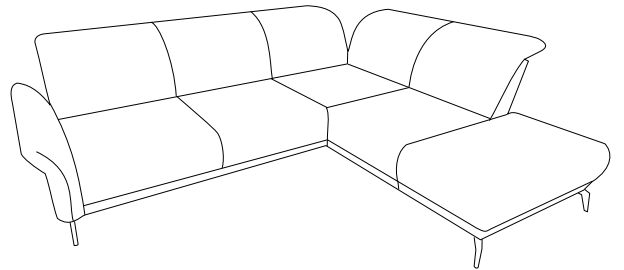
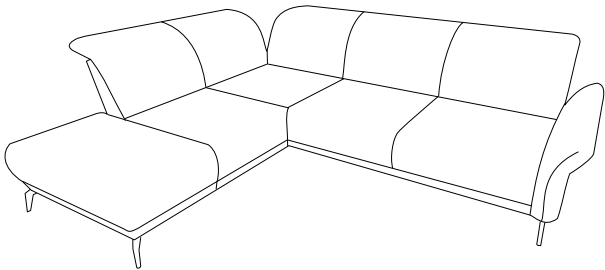
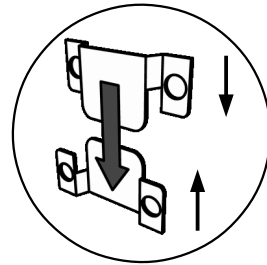
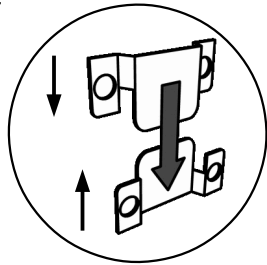
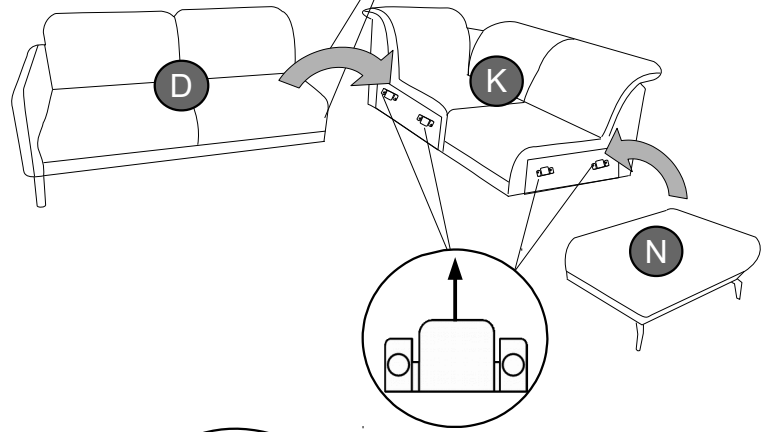
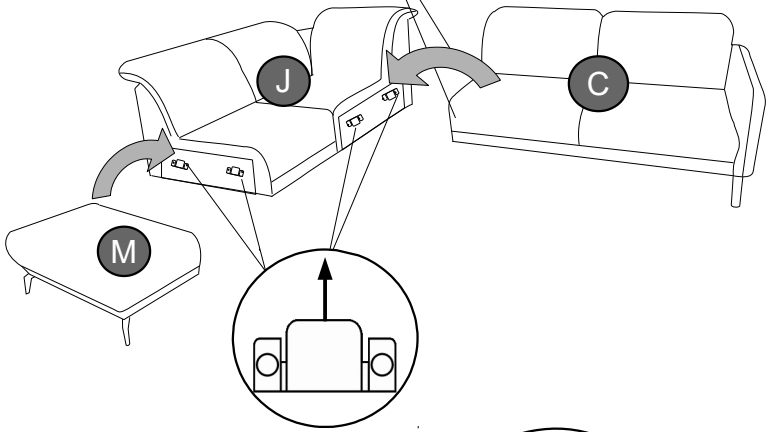
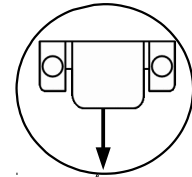
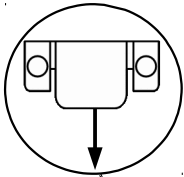
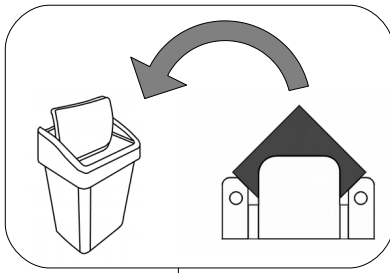

Service · Dienstverlening · Servis · Servis · Сервисная служба · Serviciu · Services · Servizio
 · Servisný list · Szolgáltatás · Servisní list

Name · Naam · Nazwa · İsim · Название · Nume · Nome · Názov · Názov ·
 Název · Neve
COCO V
 Typ · Type · Tip · Тип · Tipo · Típus

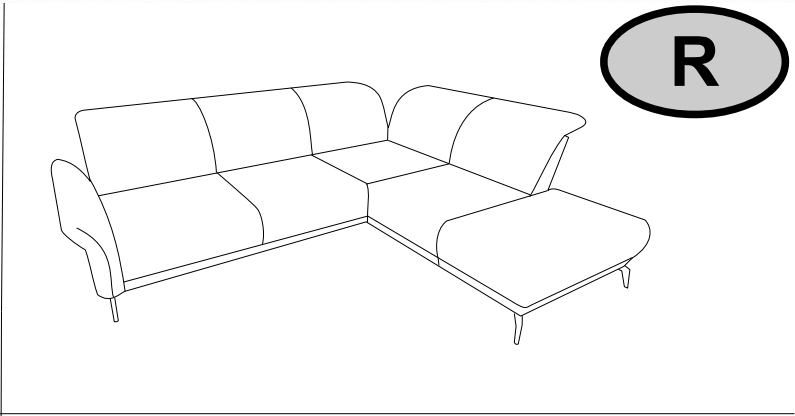
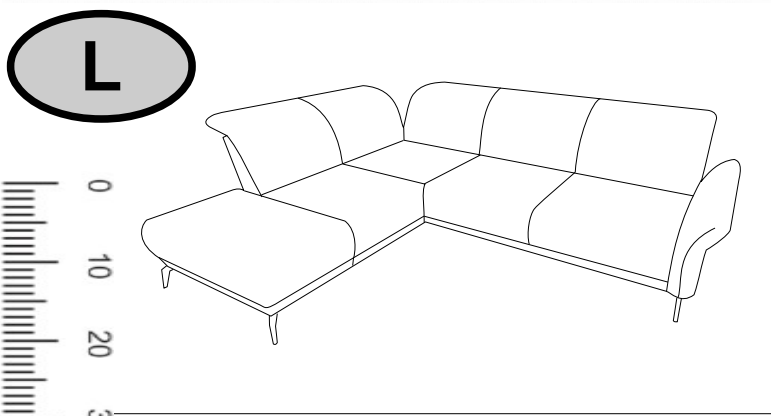
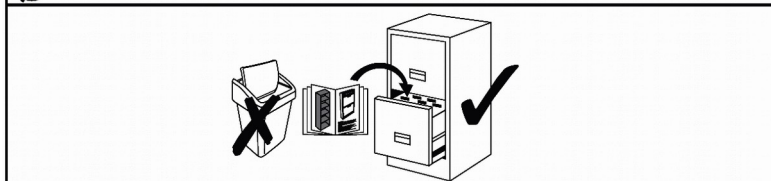
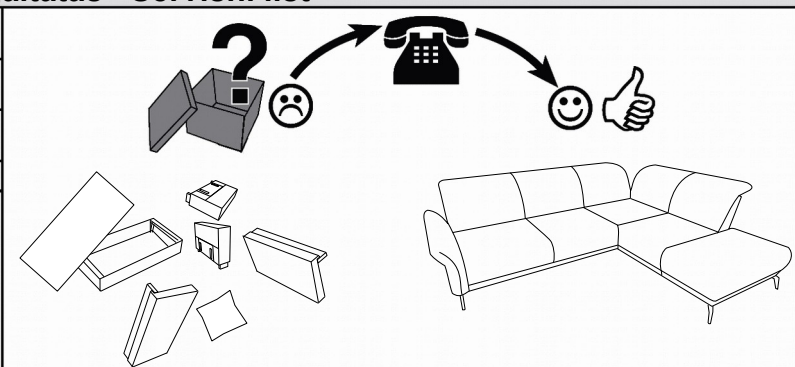

g H-150 	v H-150 	i L-4 	s H-150 s ₁	q M6*25 [mm]
--------------------	--------------------	------------------	--------------------------------------	-------------------------

