

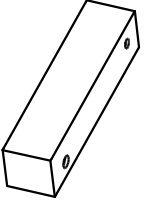

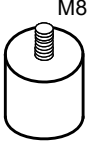











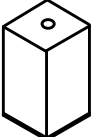

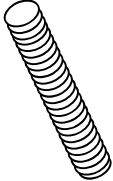
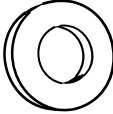
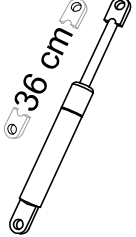
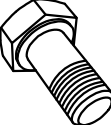
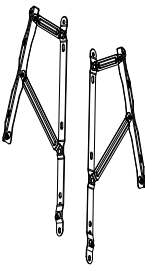
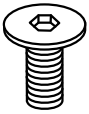
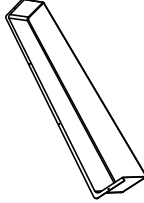
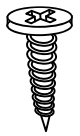
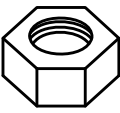
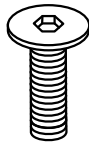
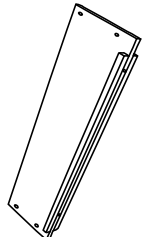
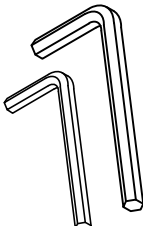
# TAMBO by meise

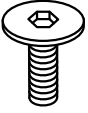
## Bettkasten / storage

120 cm  
 140 cm

A-32	B-32	C-32	D-32	E-32	F-32	G-32	H-32	I-32
2	2	6	20	4	4	4	2	2
								
H 50	H 50		M6*20	M6*25	M6	M6	H 70	983*1170 983*1370
J-32	K-32	L-32	M-32	N-32	OL/OR-32	P-32	Q-32	R-32
8	4	4	2	4	1 / 1	3	2	16
								
	M8*50	M8*16	850 N	M8*16		M8*20	820*95*60	3,5*16
S-32	T-32	U-32	V-32	W-32	X-32	Y-32	Z-32	AA-32
4	3	1	-	1 / 1	4	-	-	2
			-			-	-	
M8	M8*40	1170 / 1370* 260		4 / 5	4*50			M6*20
AB-32	AC-32	AD-32	AE-32	AF-32	AG-32	AH-32	AI-32	AJ-32
-	-	-	-	-	-	-	-	-
-	-	-	-	-	-	-	-	-
    								

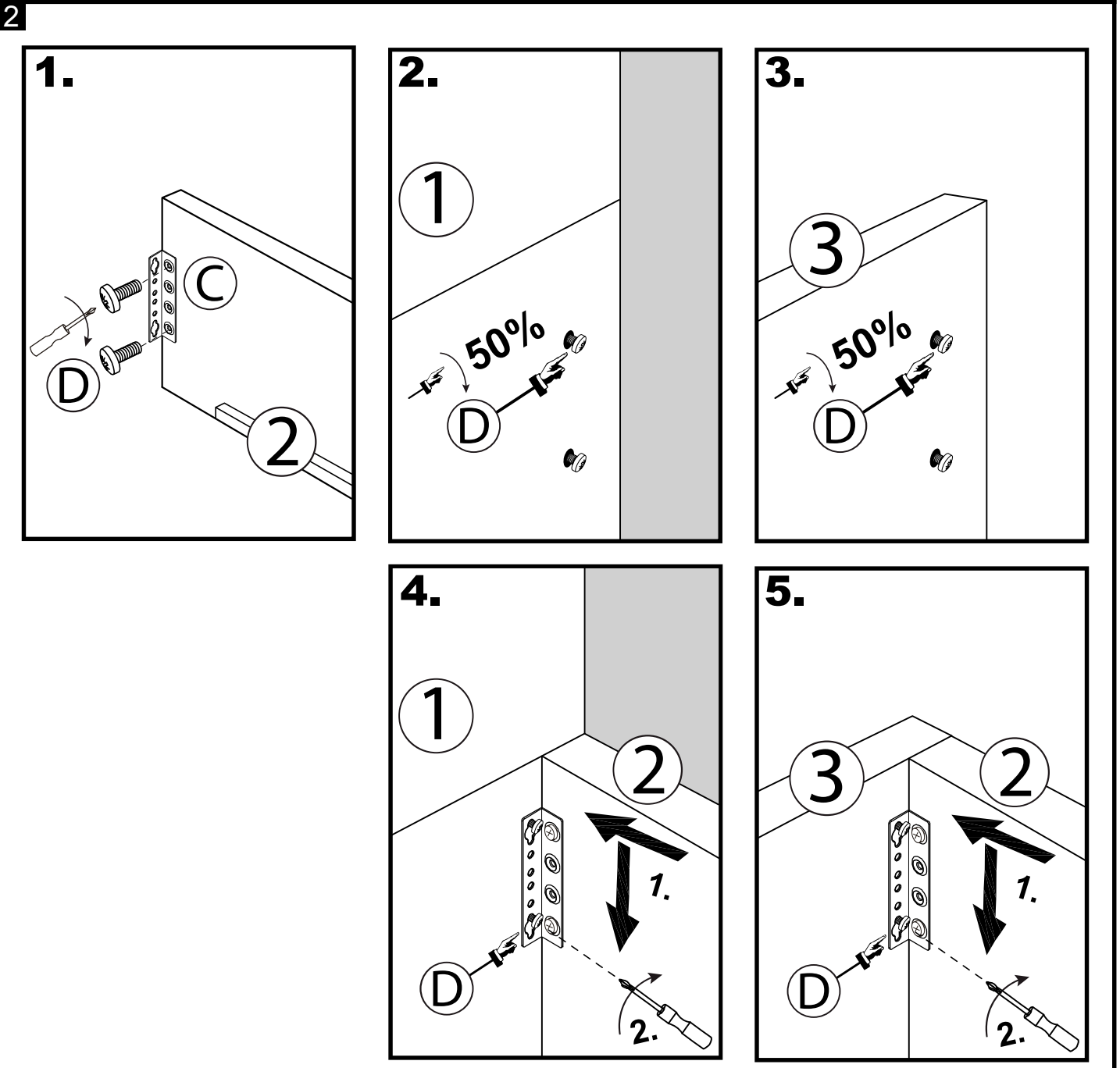
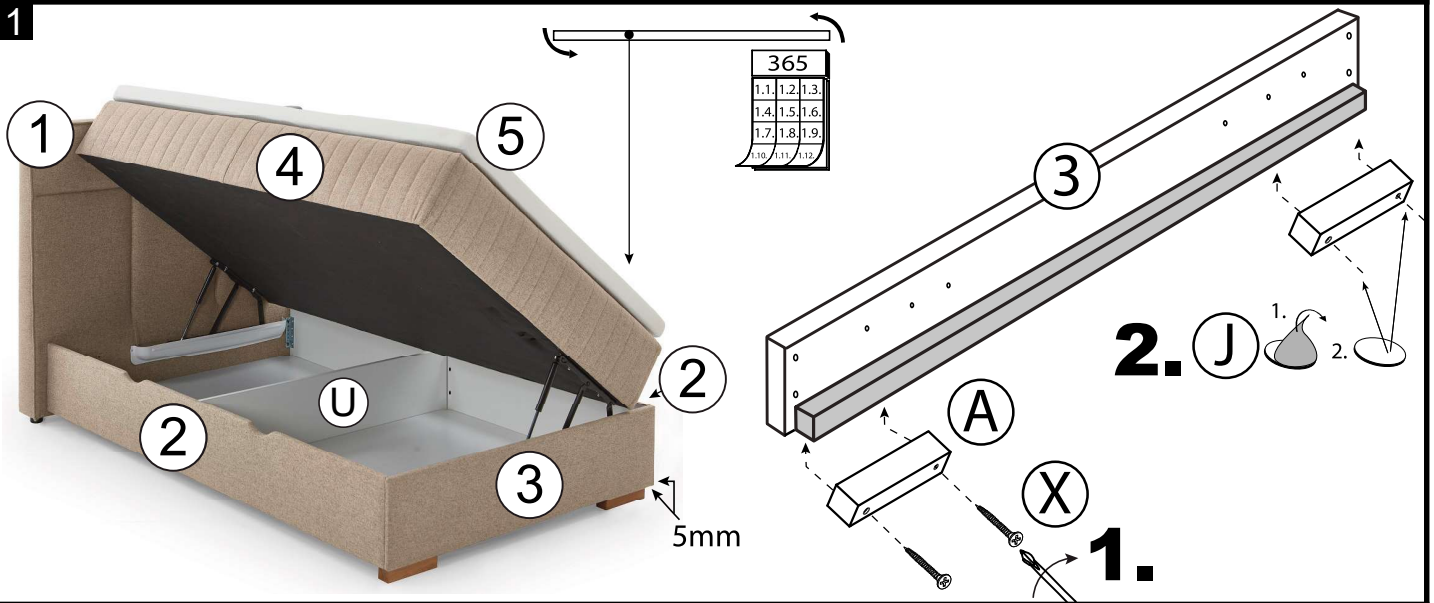

3

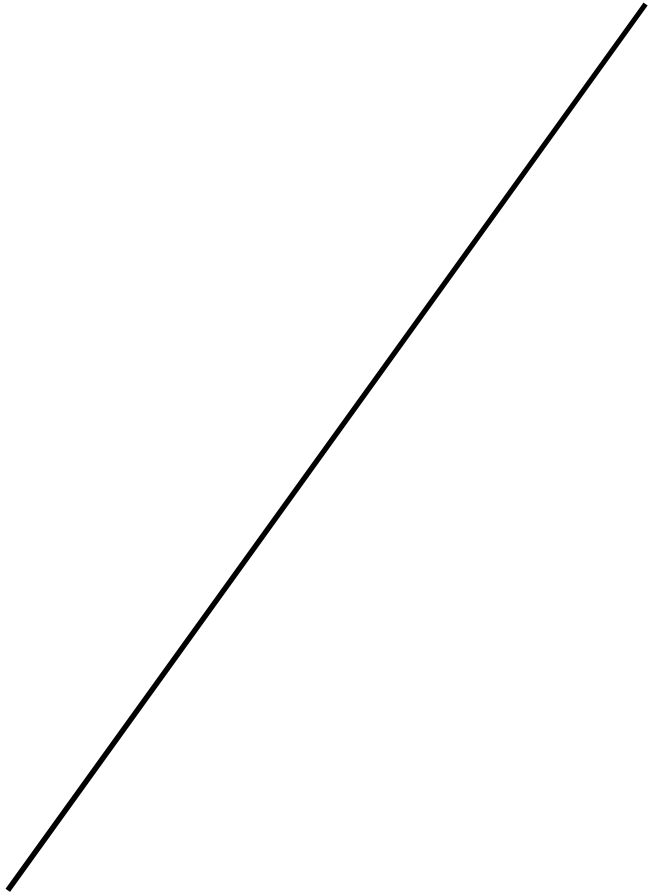

4

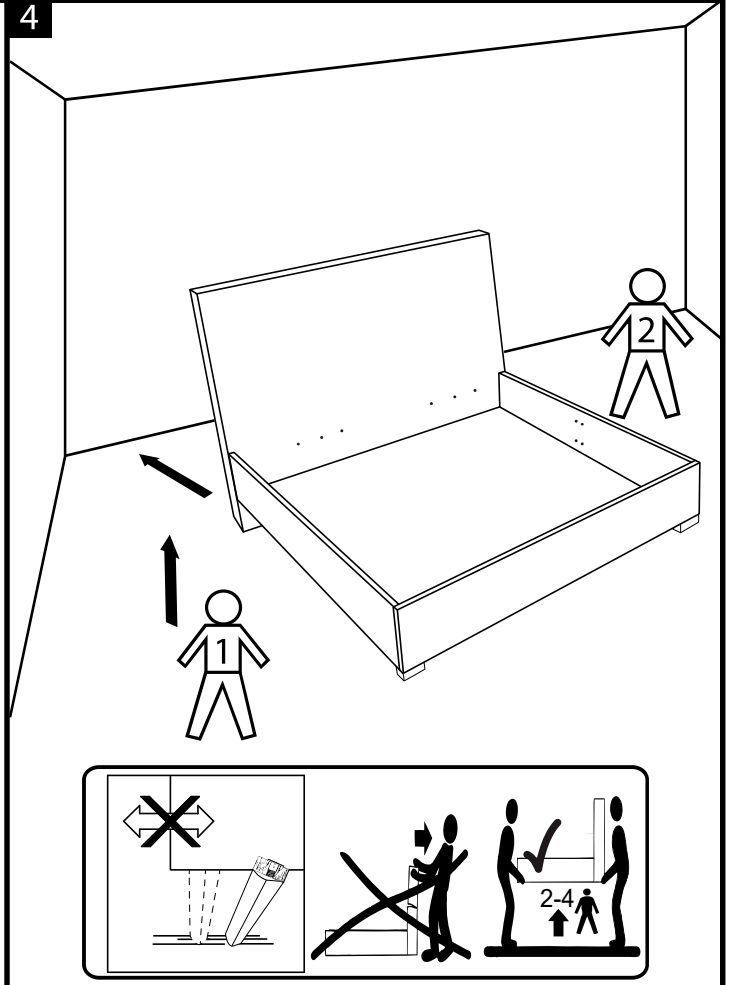

5

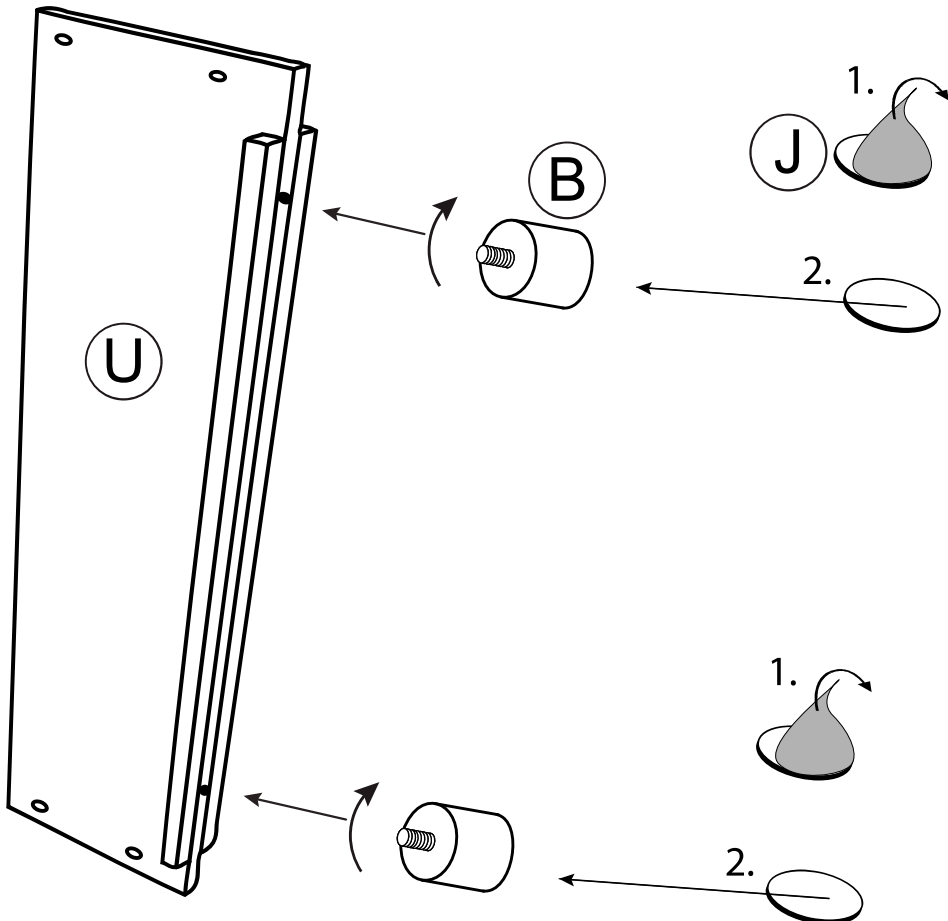

6

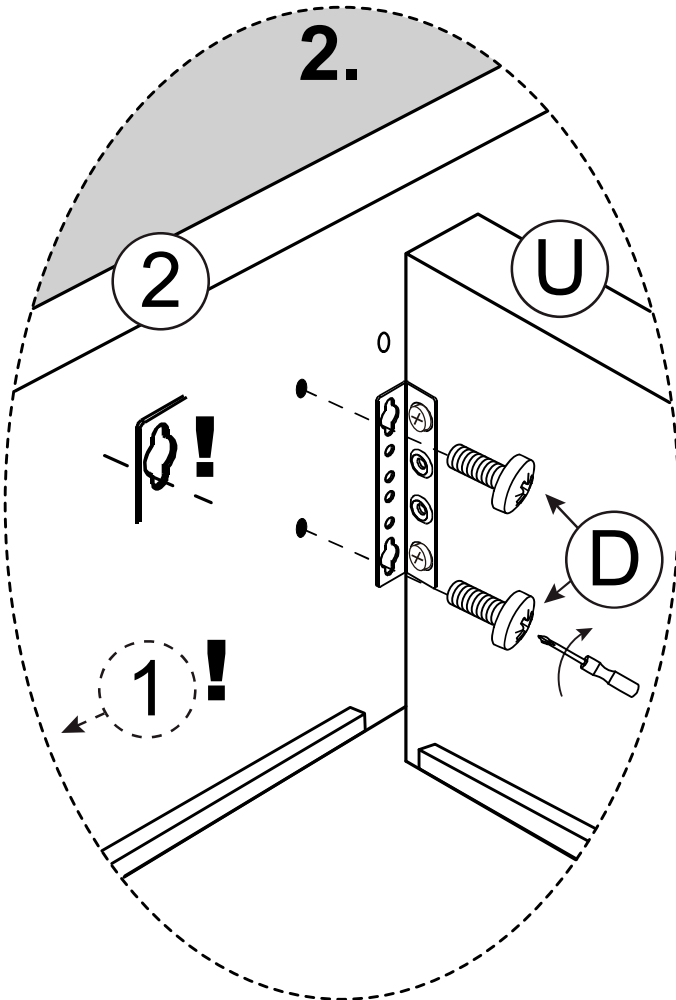
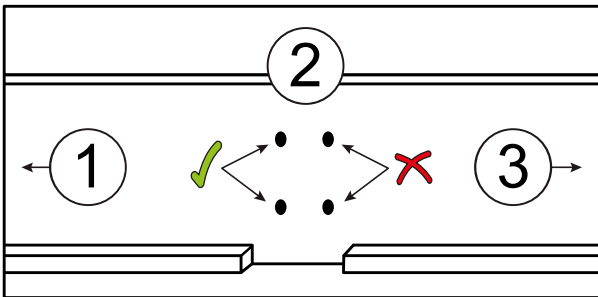
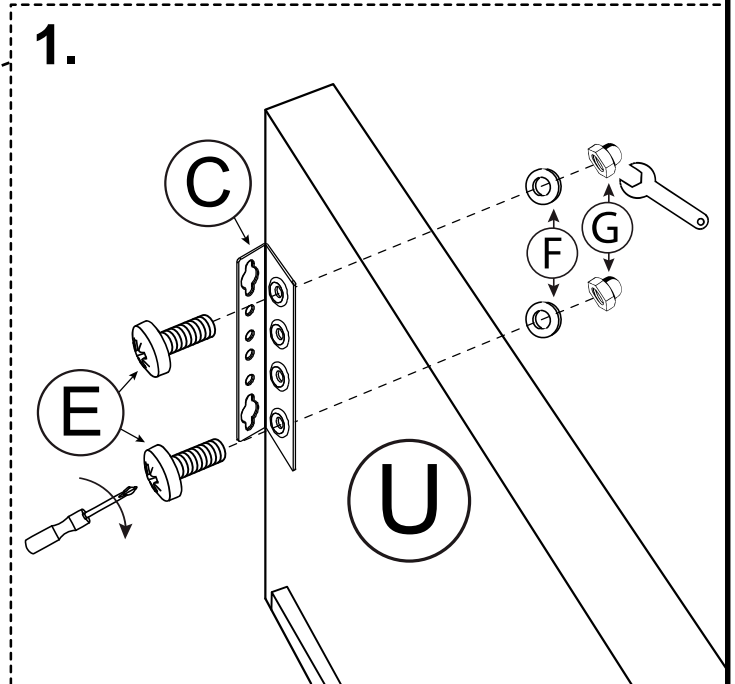
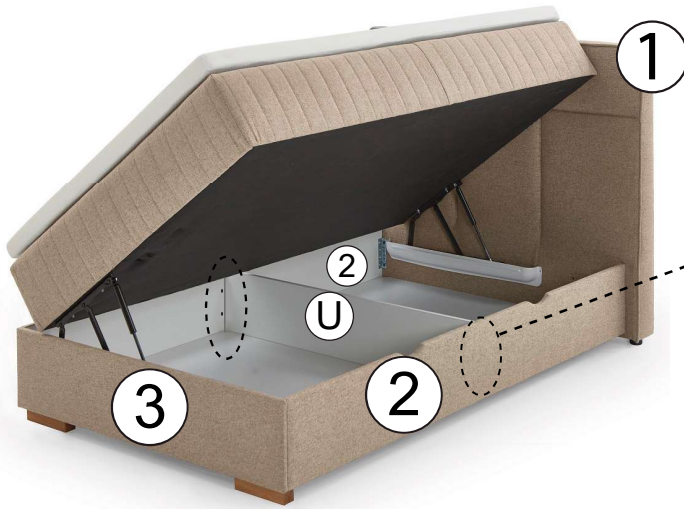

**7**

1.  $1 \times$  AA, W, I, H

2.  $M1 = M2$   
 $2 / 3 = 90^\circ$

3.  $8 \times R$ , M1, M2

4.  $1$ ,  $2$ ,  $3$

5.  $1 = <5\text{KG}$

**8**

1.  $M$ ,  $N$ ,  $OL/OR$

2.  $OL/OR$ ,  $T$ ,  $W$ ,  $1$

3.  $OL$ ,  $P$ ,  $3$ ,  $W$

$1 = <5\text{KG}$

9

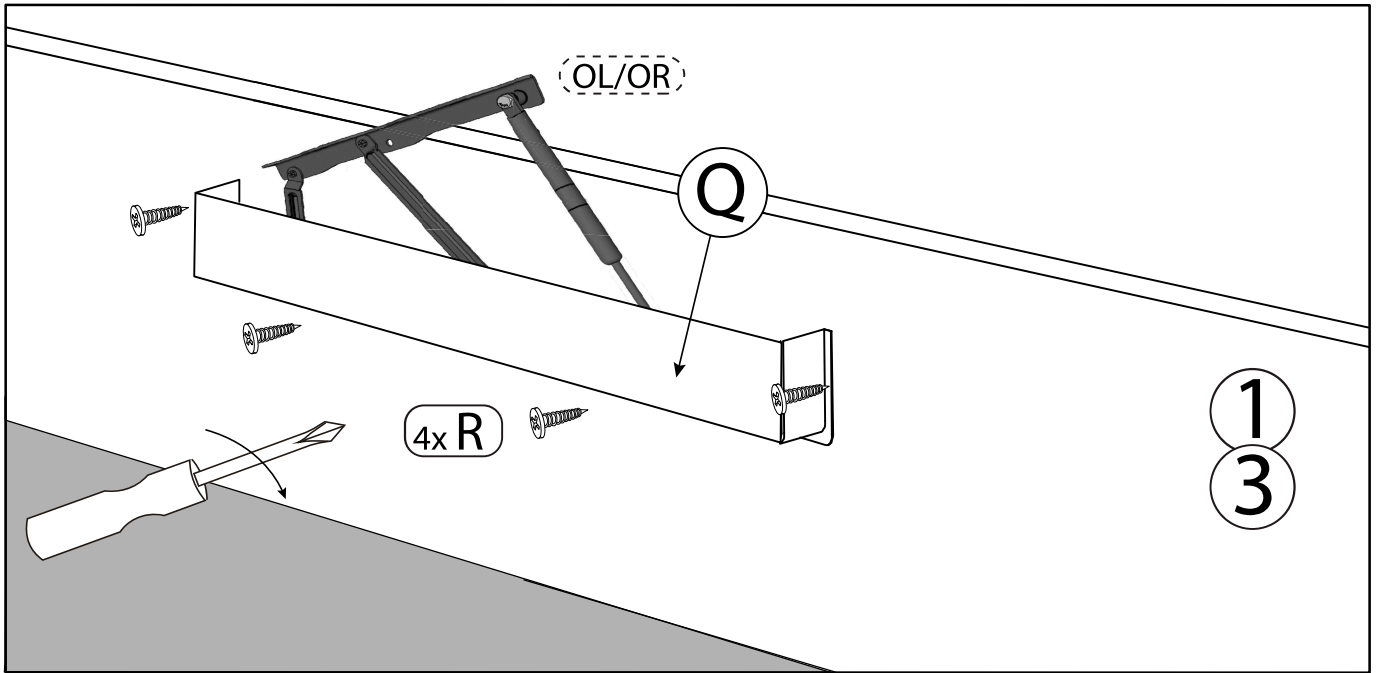

10

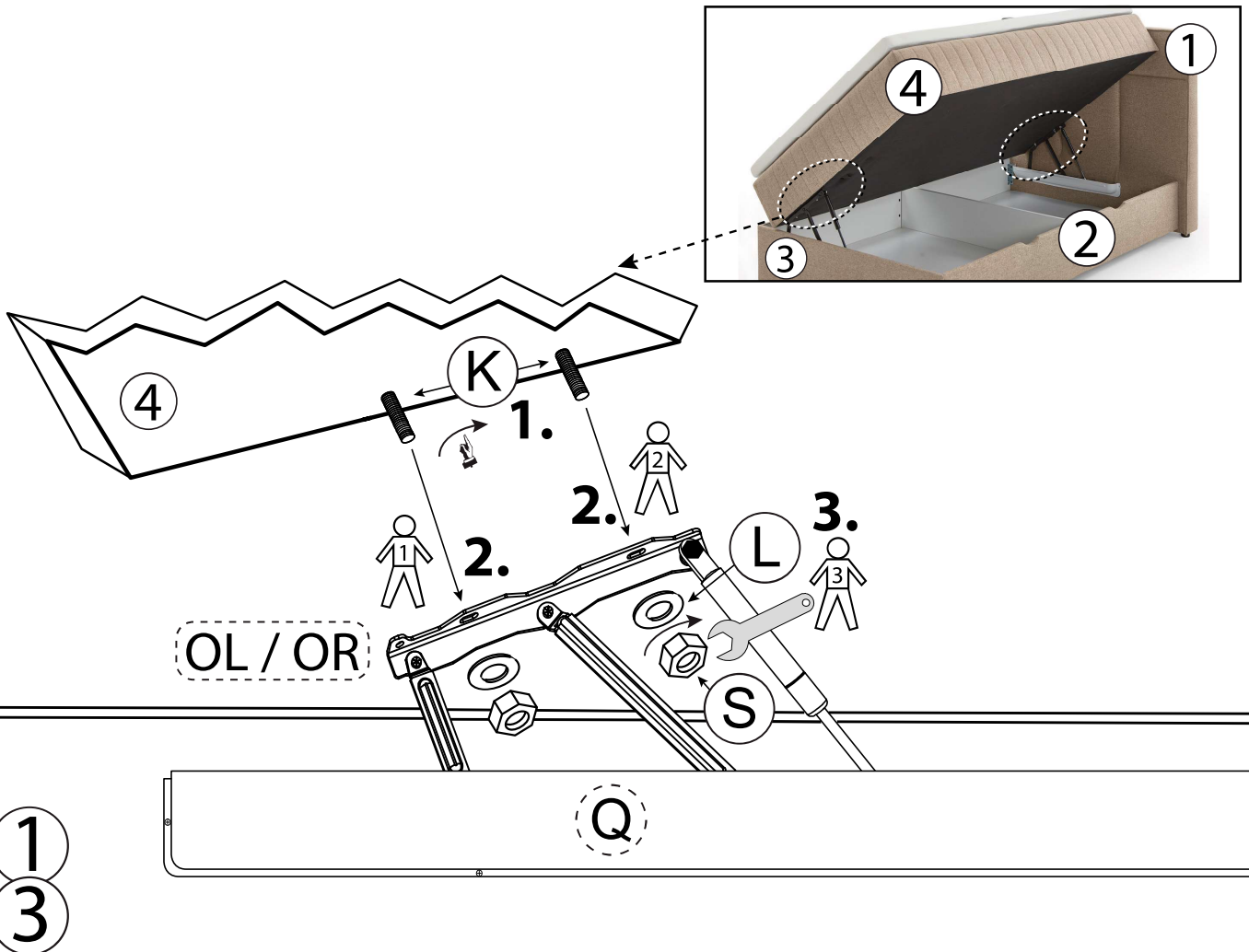

11

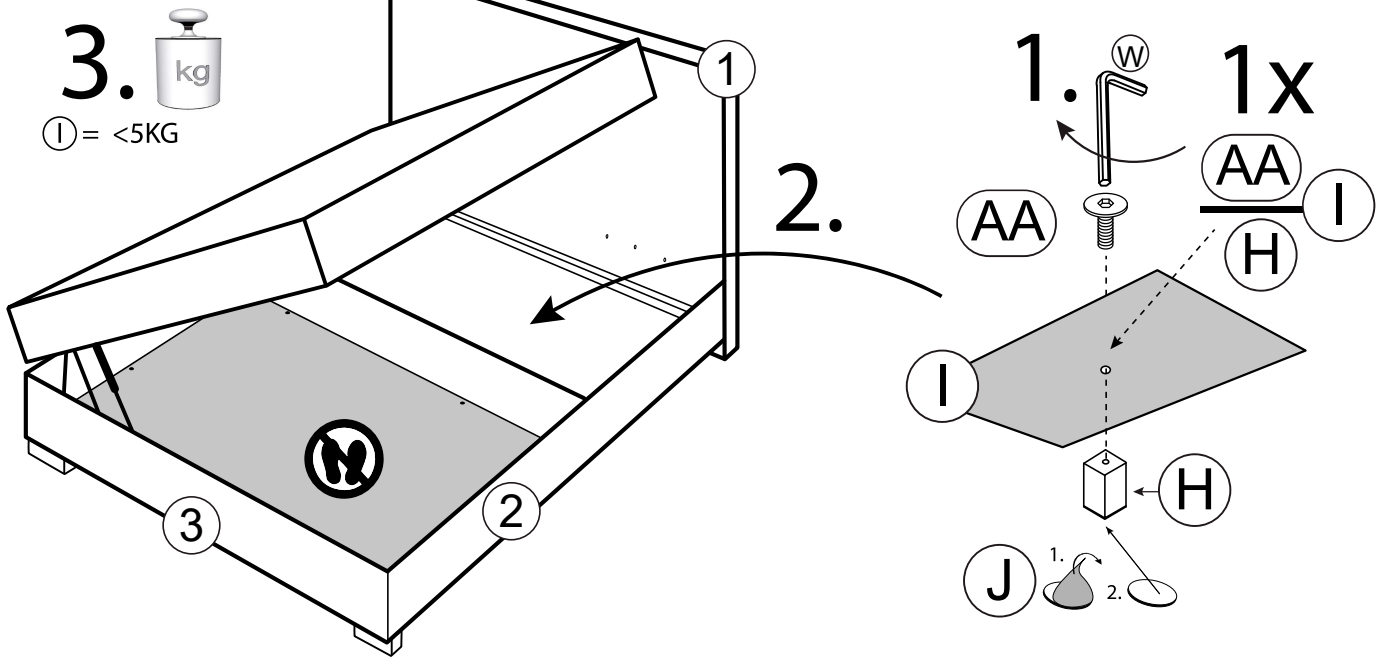

12

