

# NERO 15

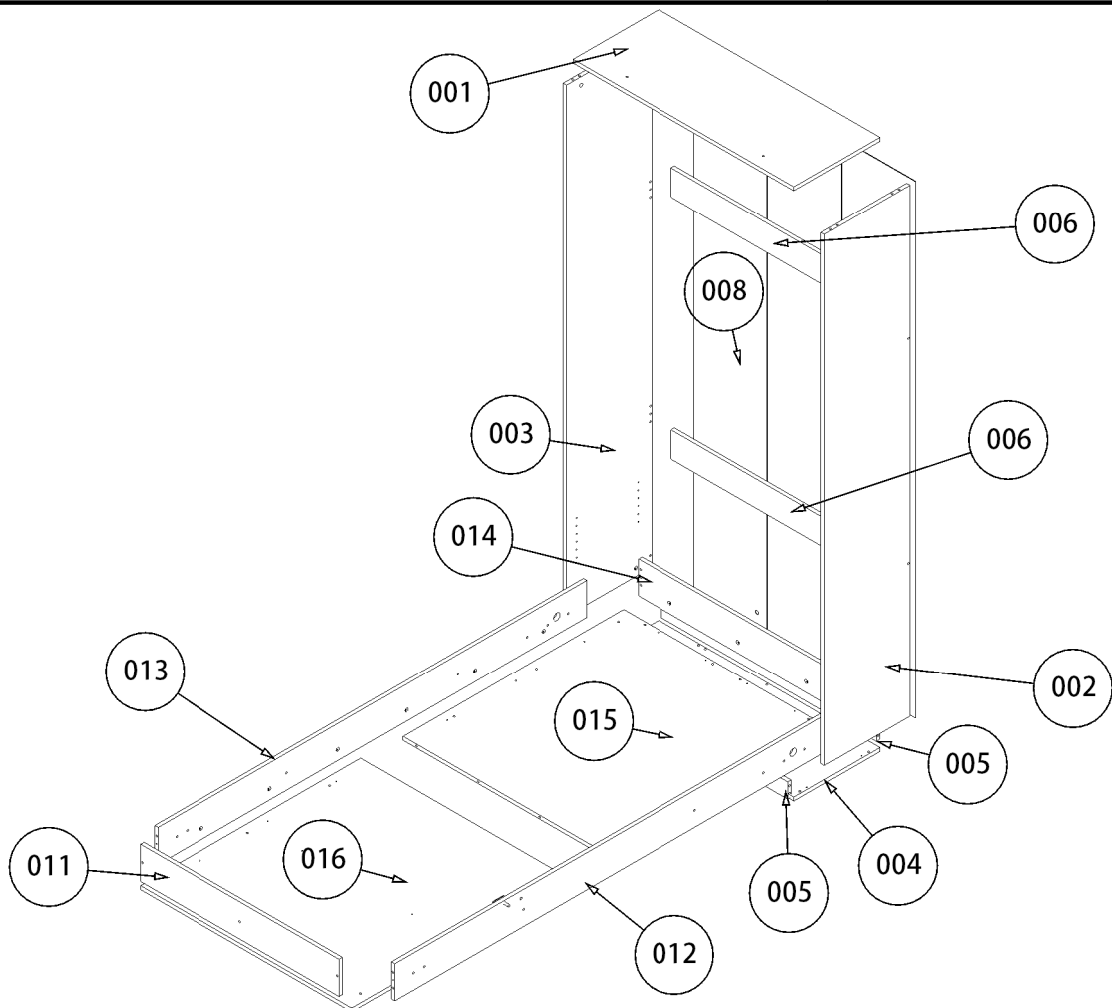

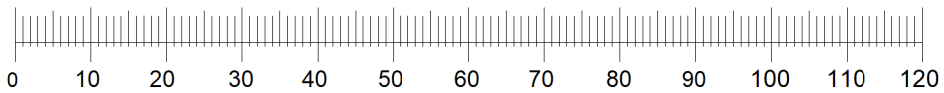

# 01

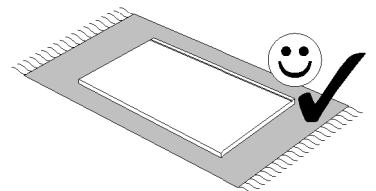
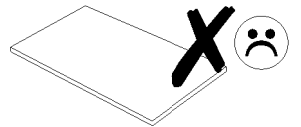
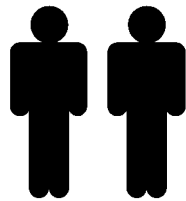
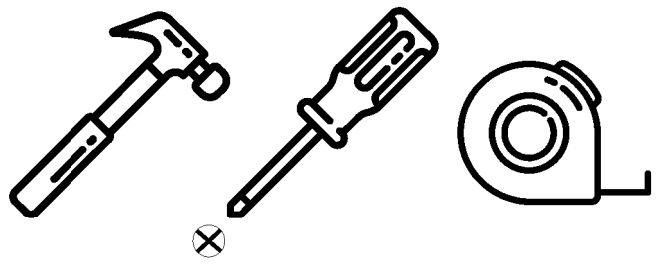
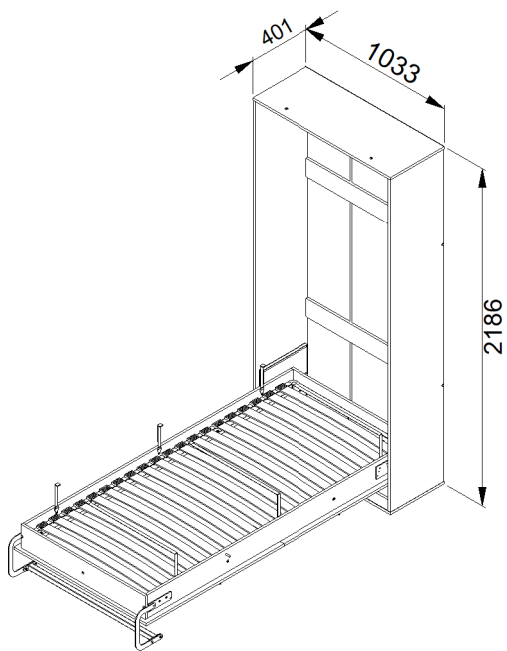
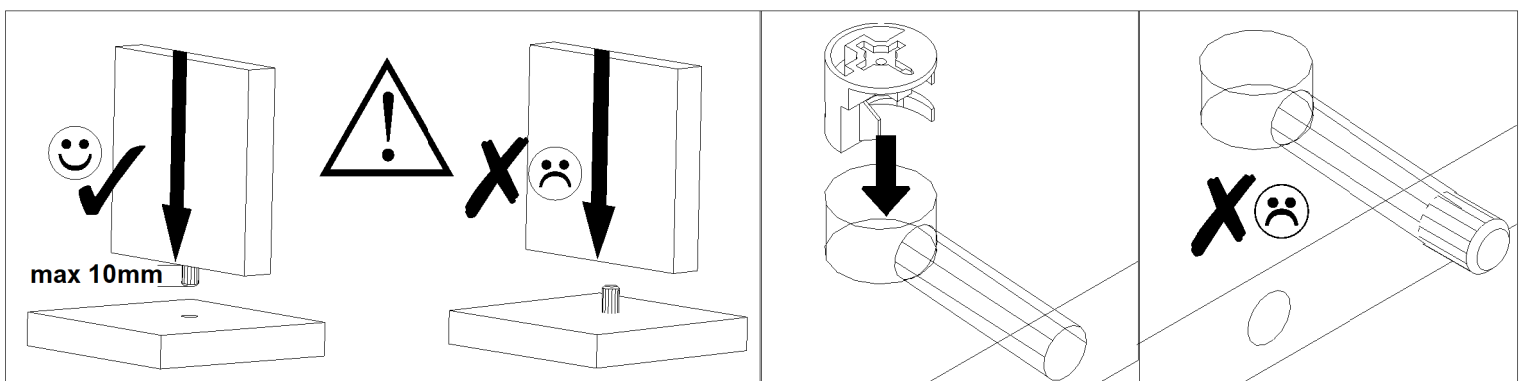
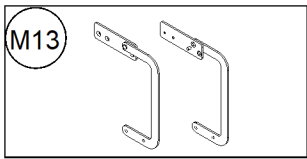
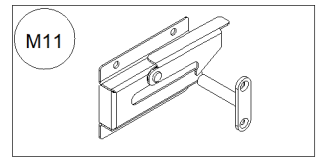
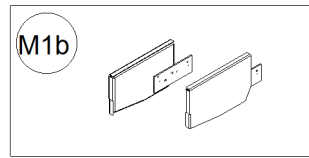
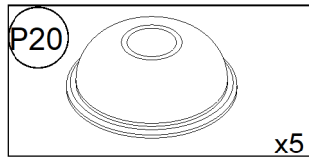
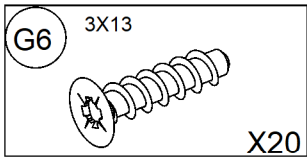
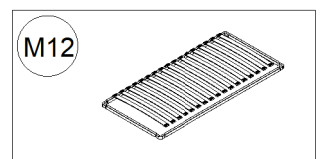
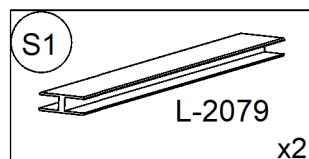
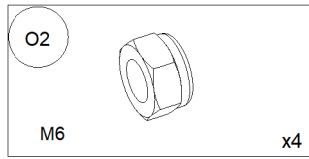
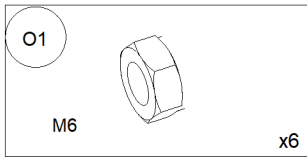
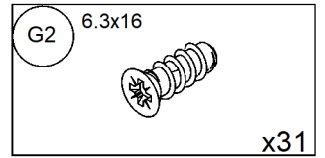
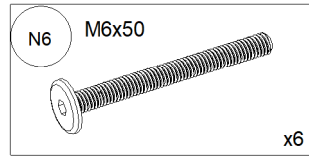
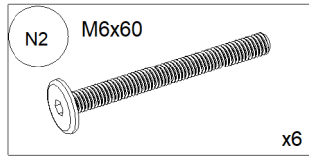
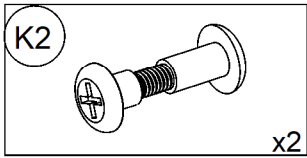
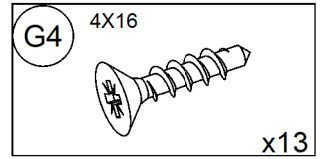
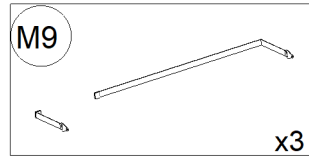
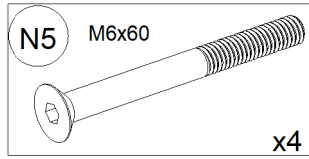
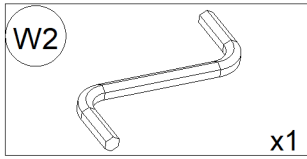
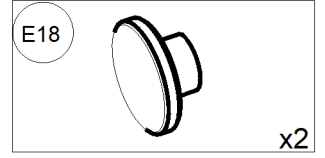
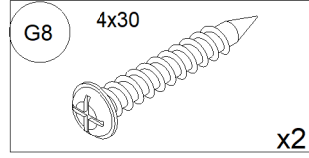
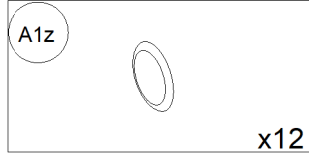
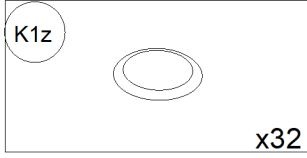
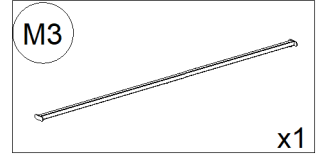
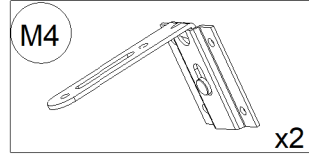
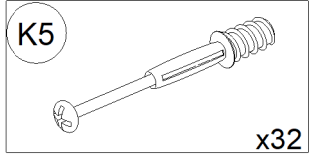
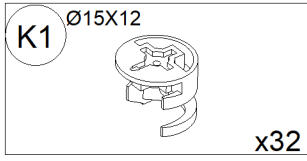
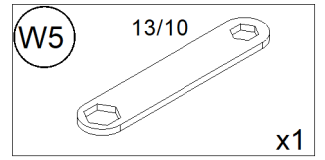
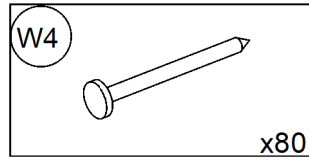
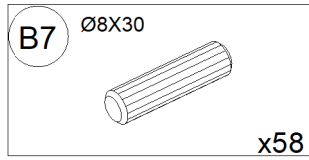
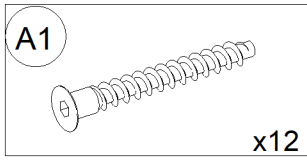
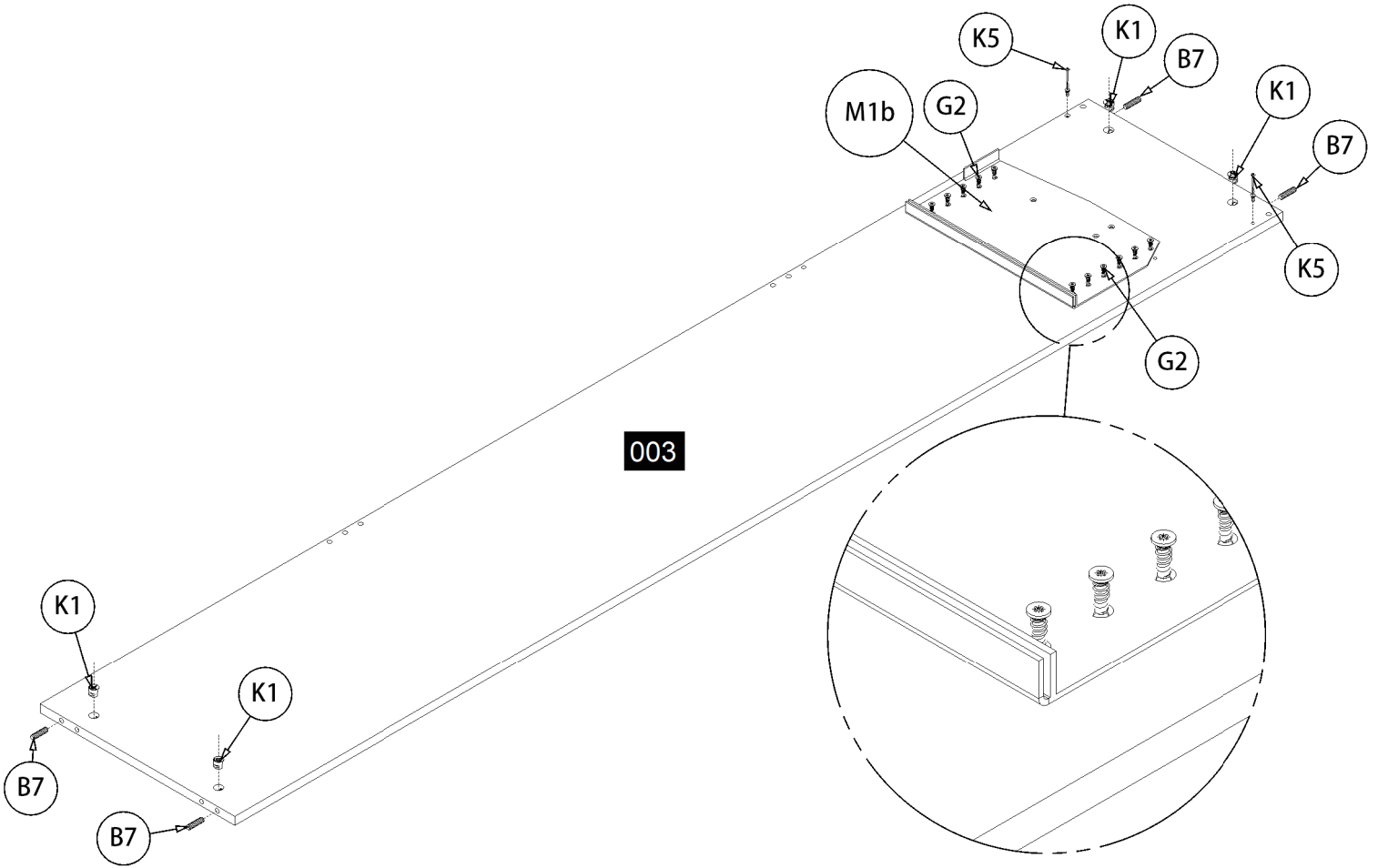
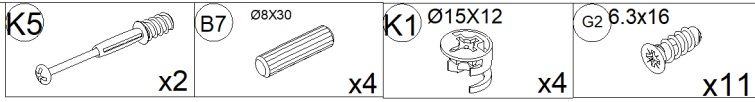

# 02

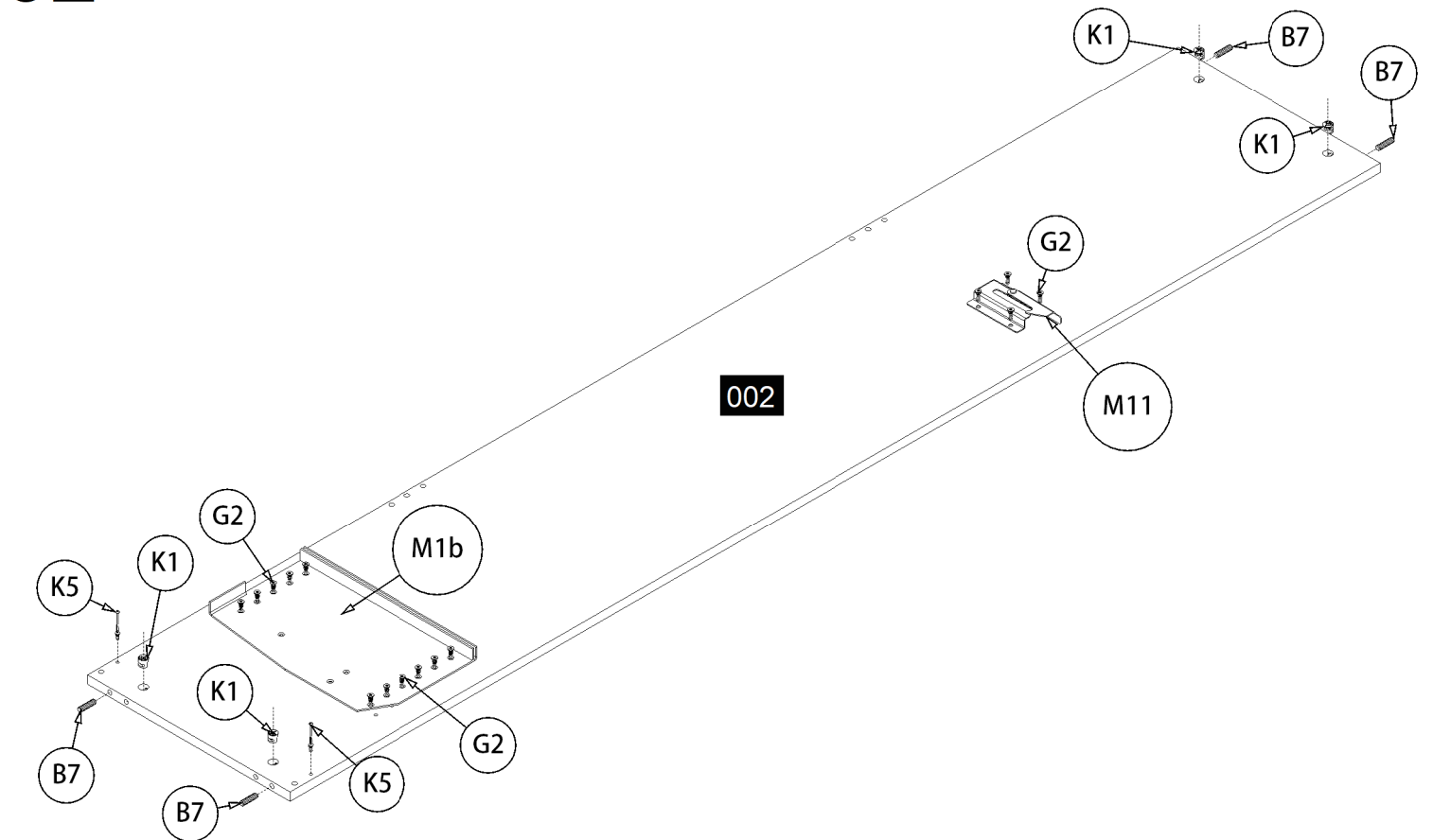
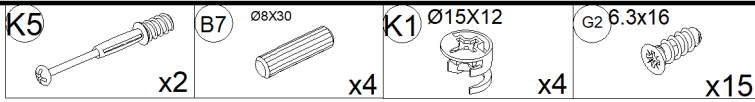

# 03

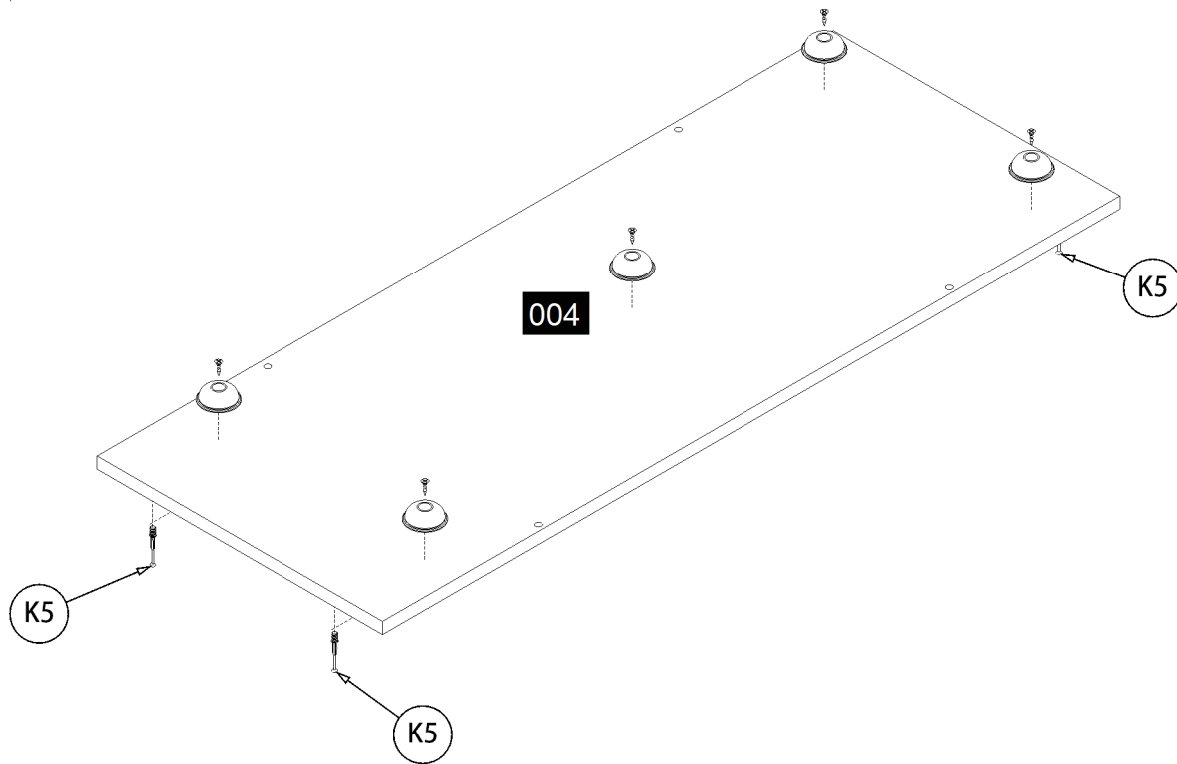
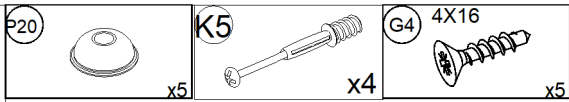

# 04

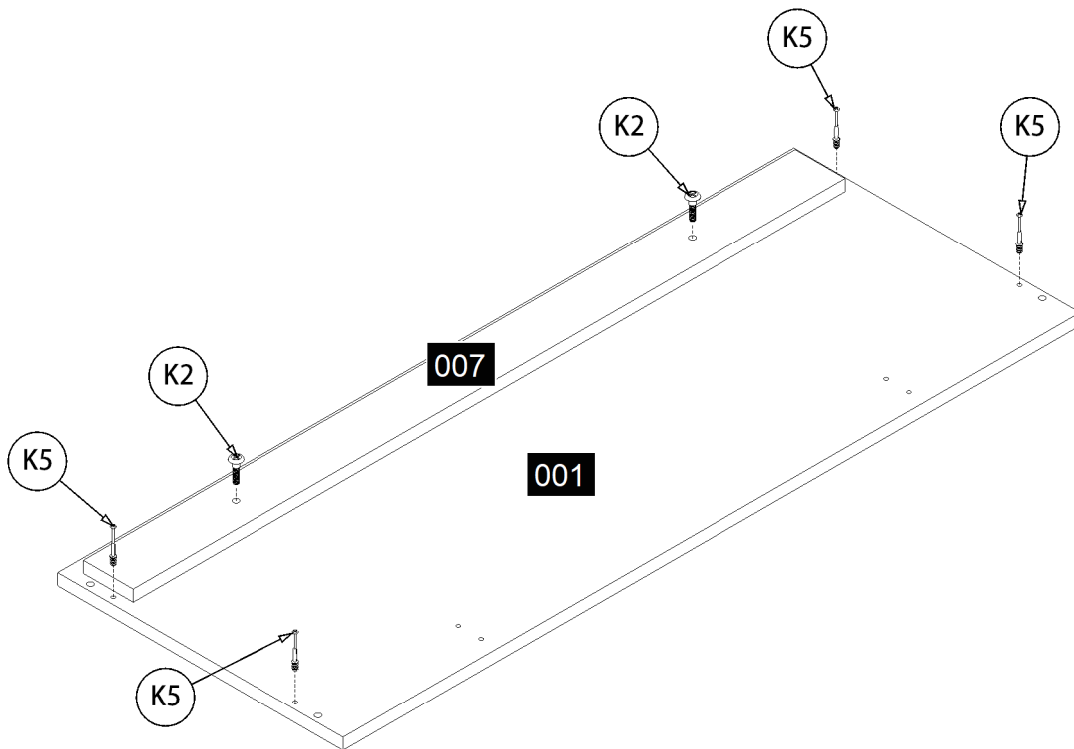
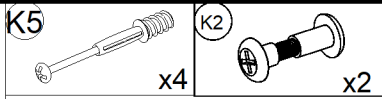

05

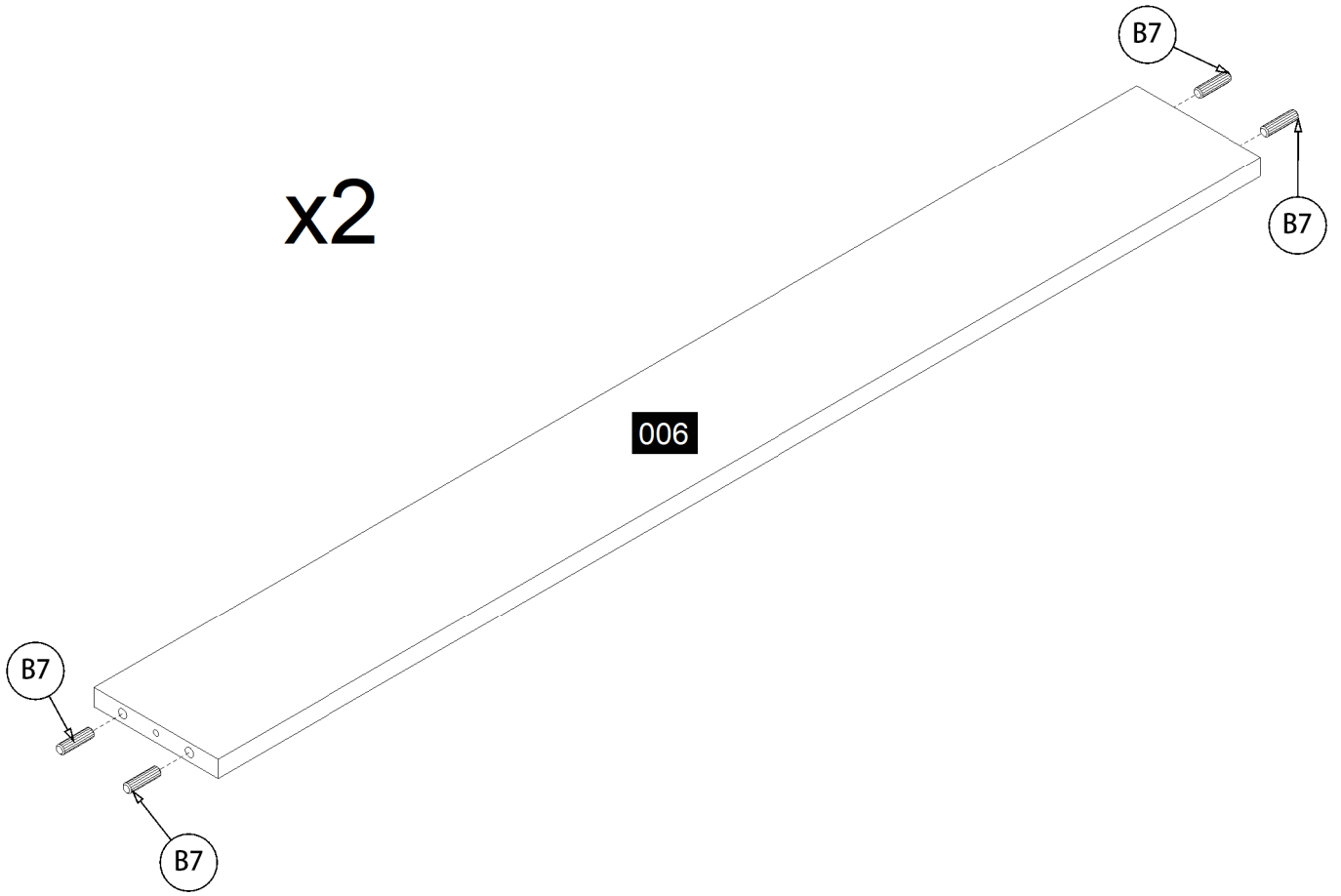
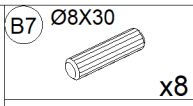

06

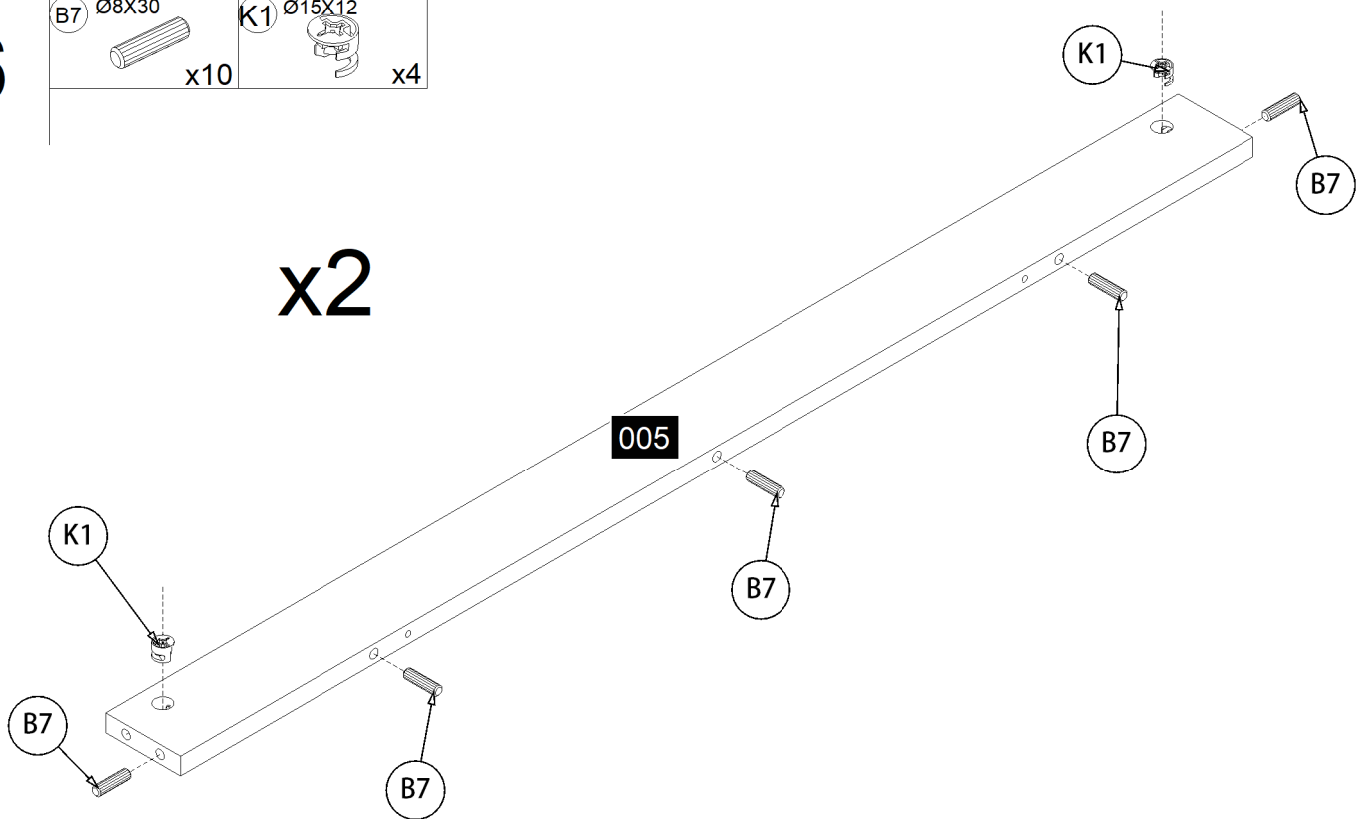
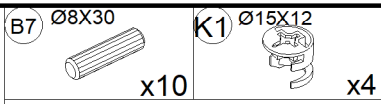

# 07

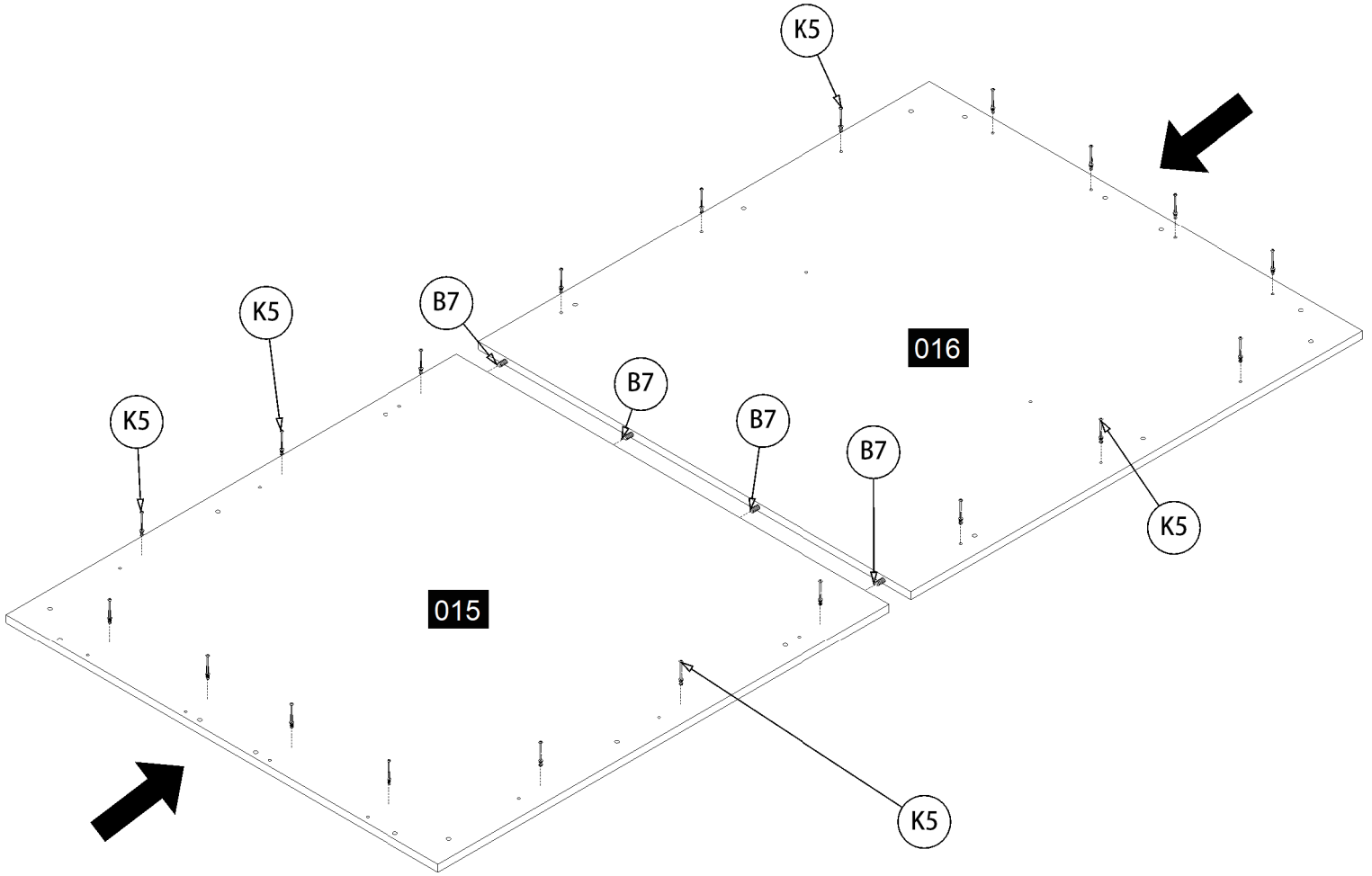
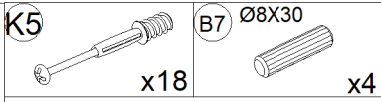

# 08

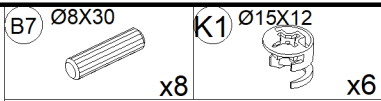

## x2

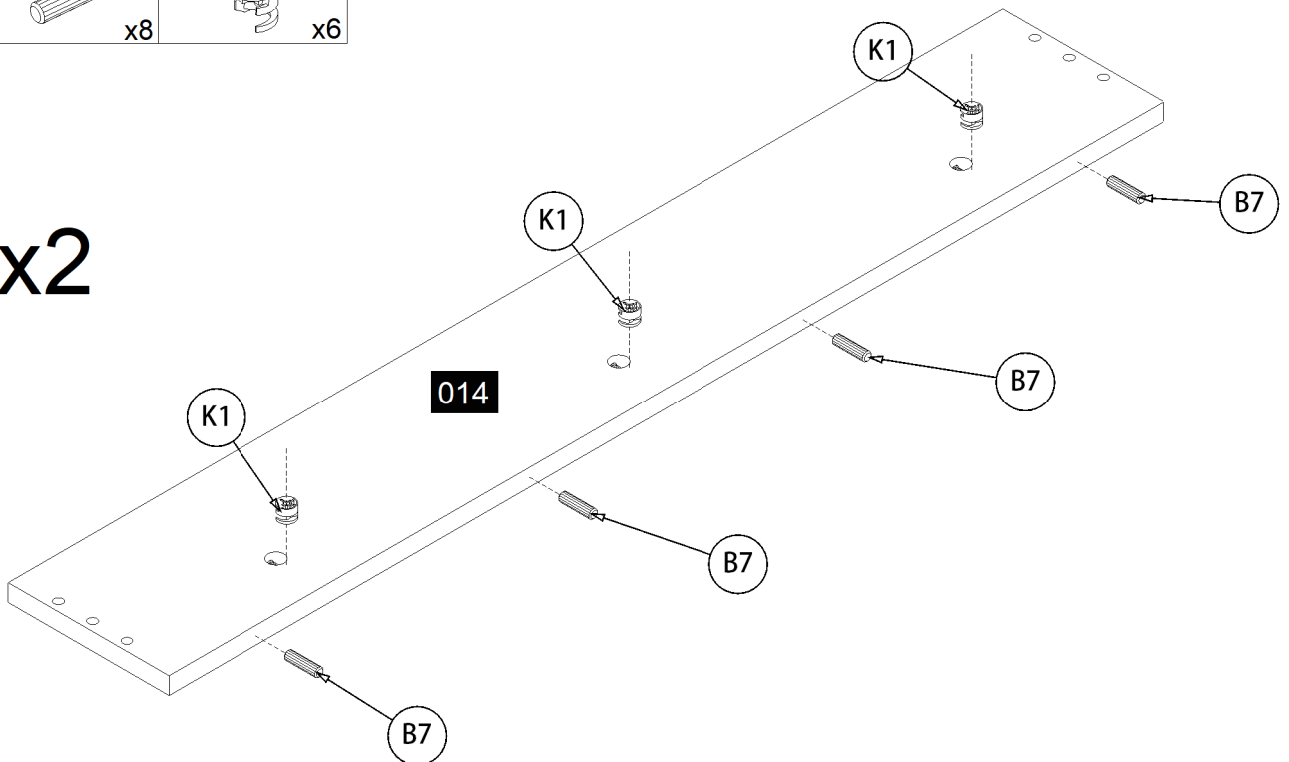

# 09

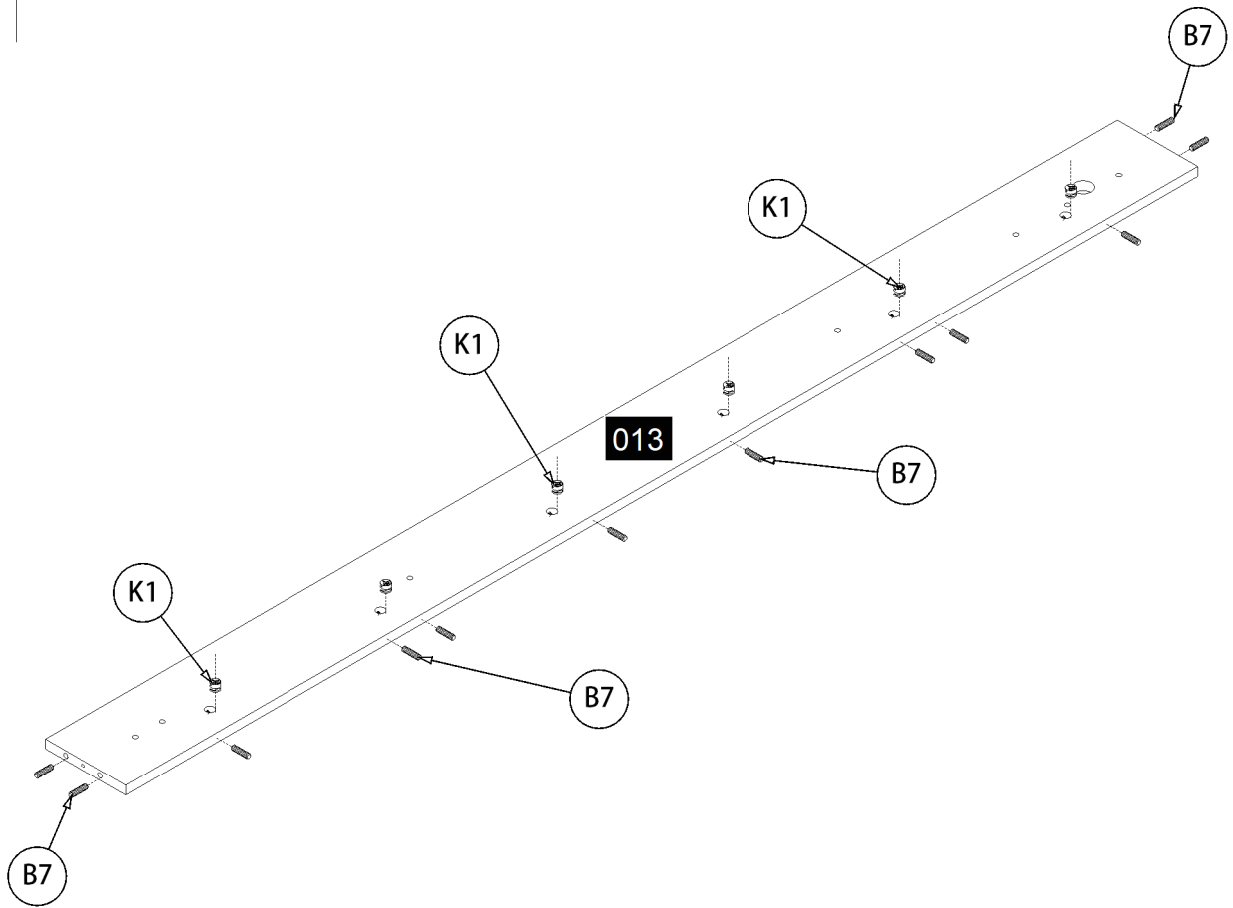
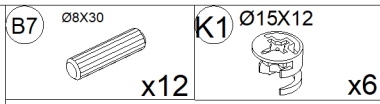

# 10

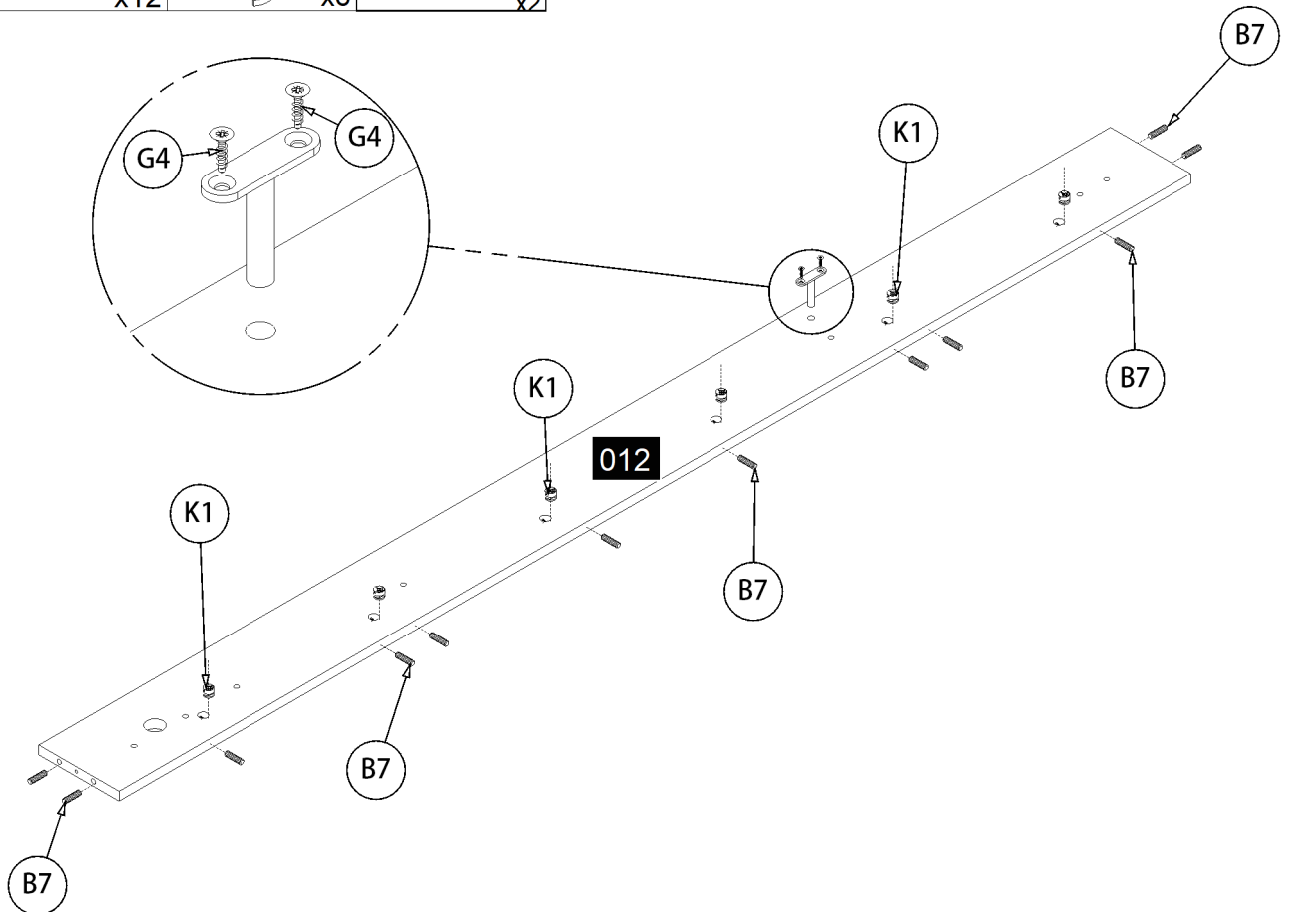
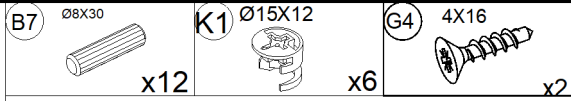

# 11

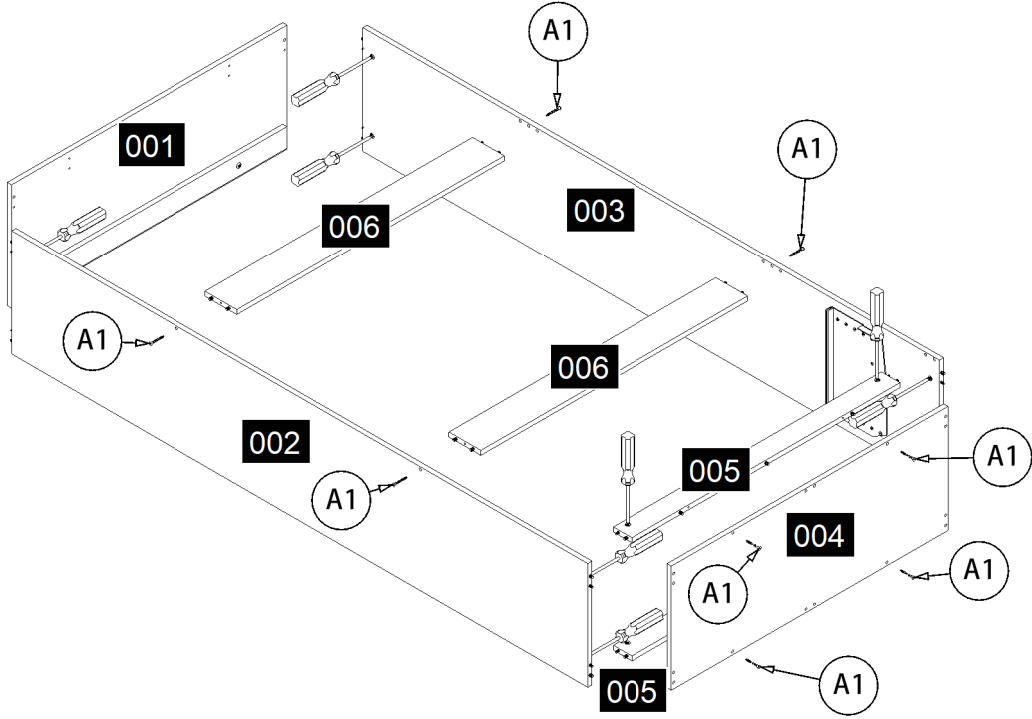
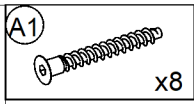

# 12

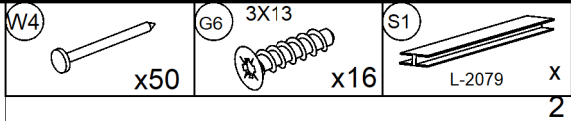

**A=B**

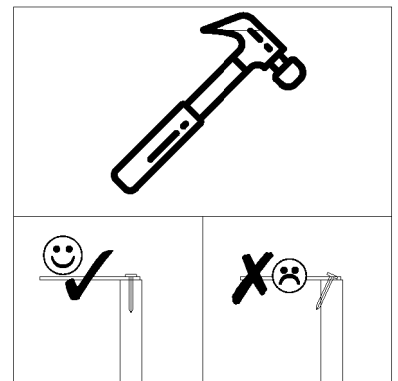
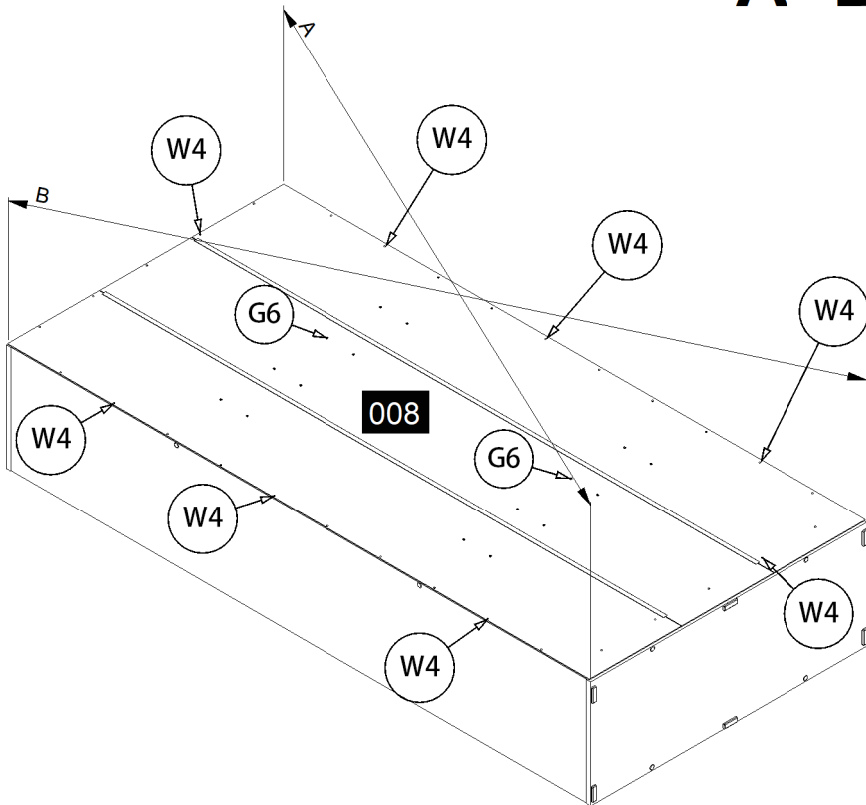
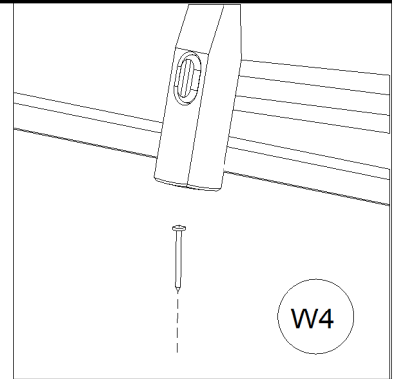



# 13

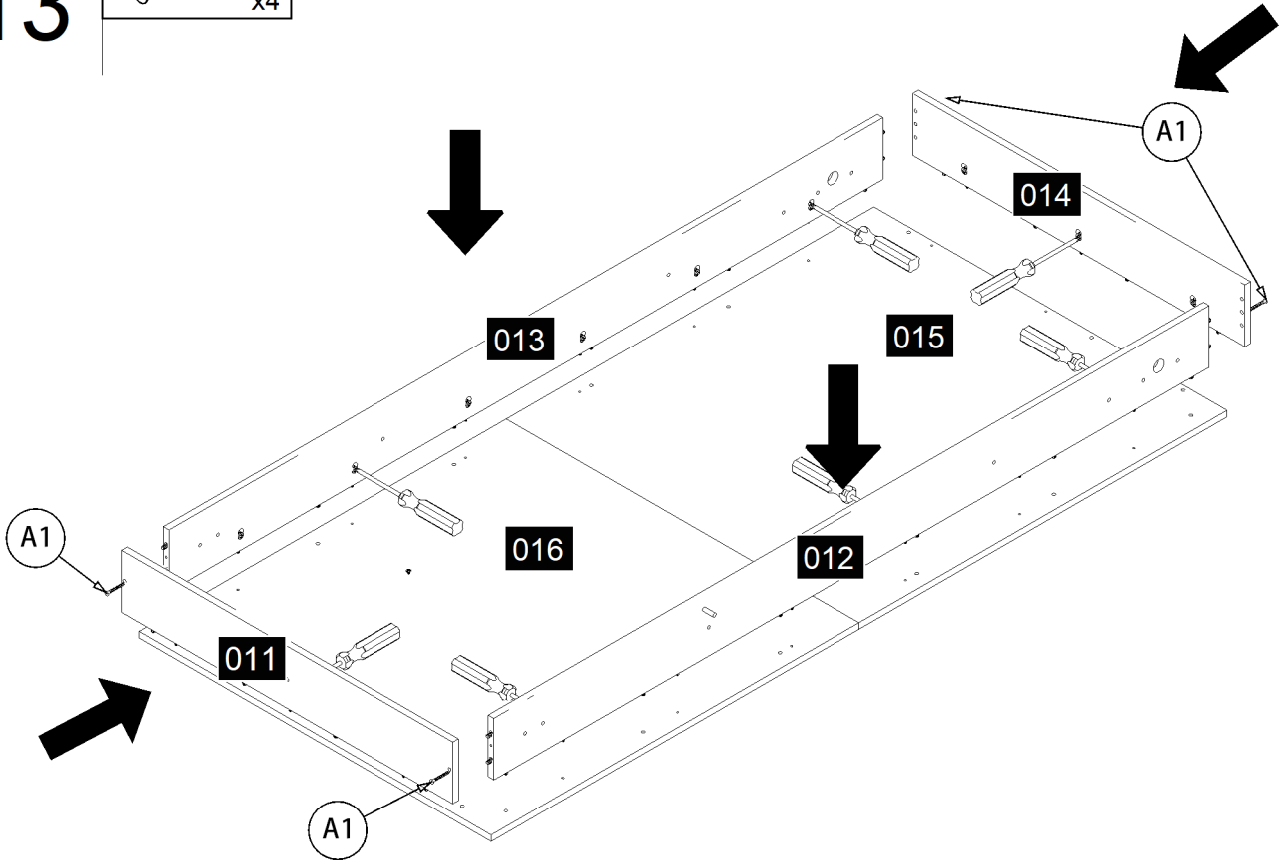
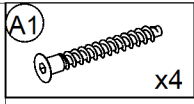

# 14

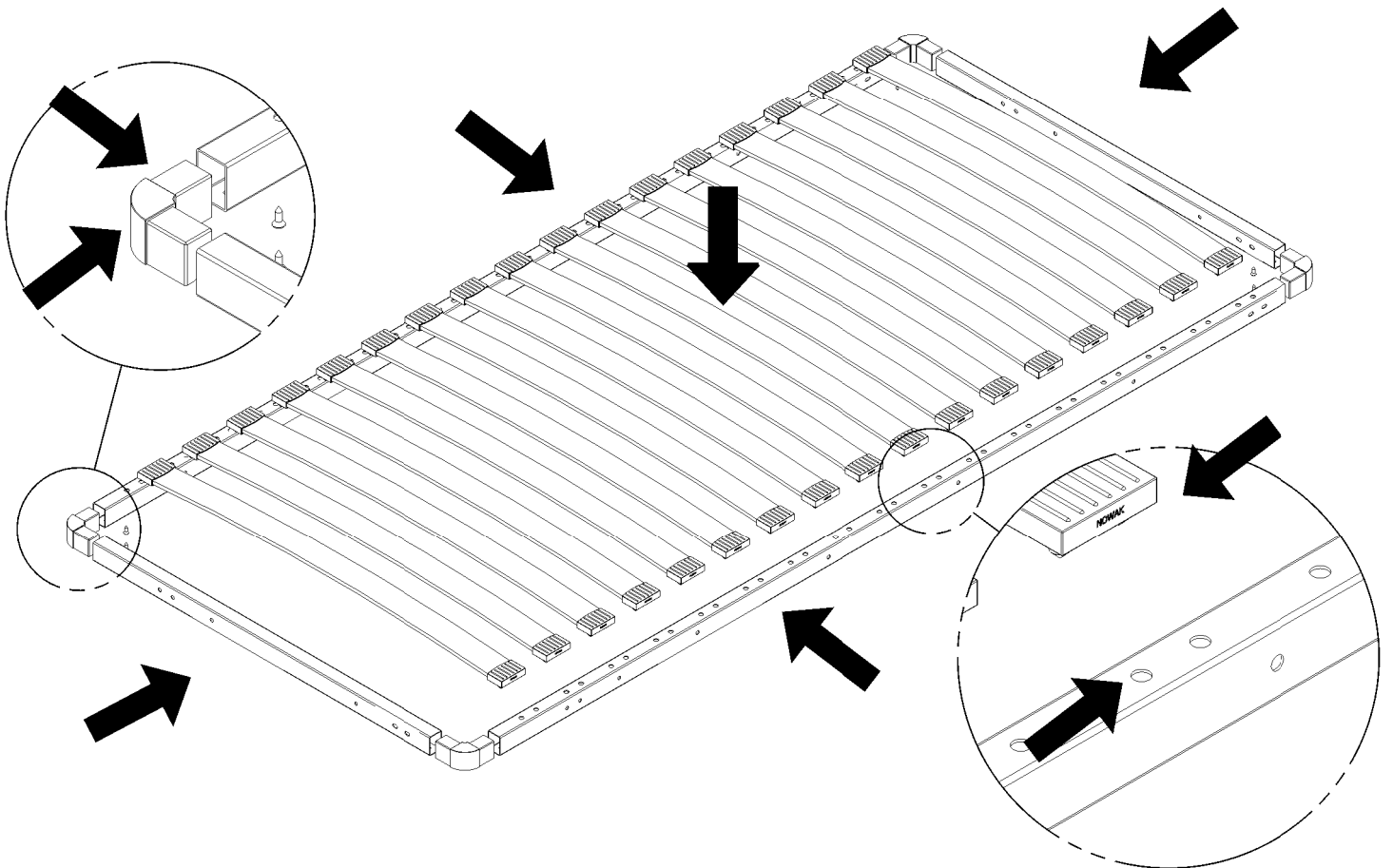

# 15

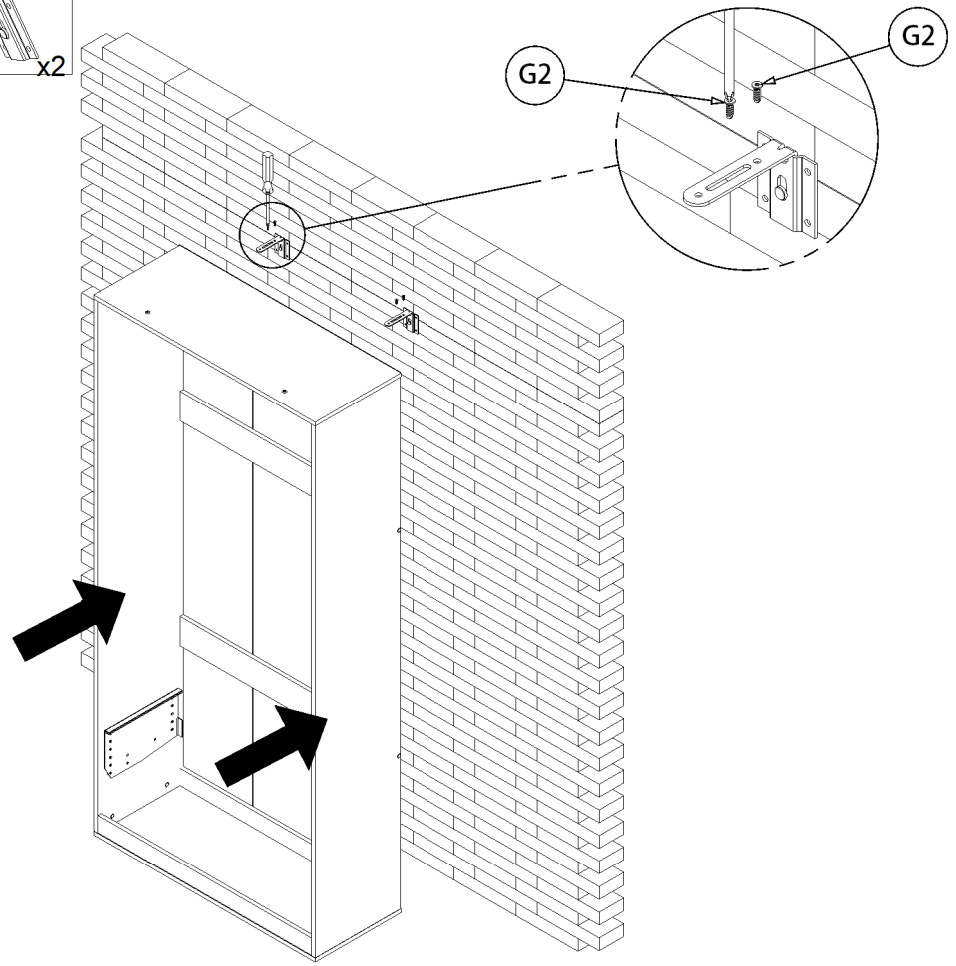
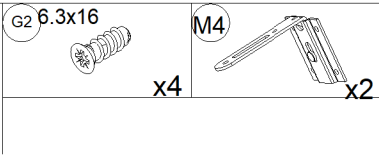

# 16

