

BED LLF

ORIGINAL INSTRUCTION MANUAL

SKU:WF319422
SKU:WF319423

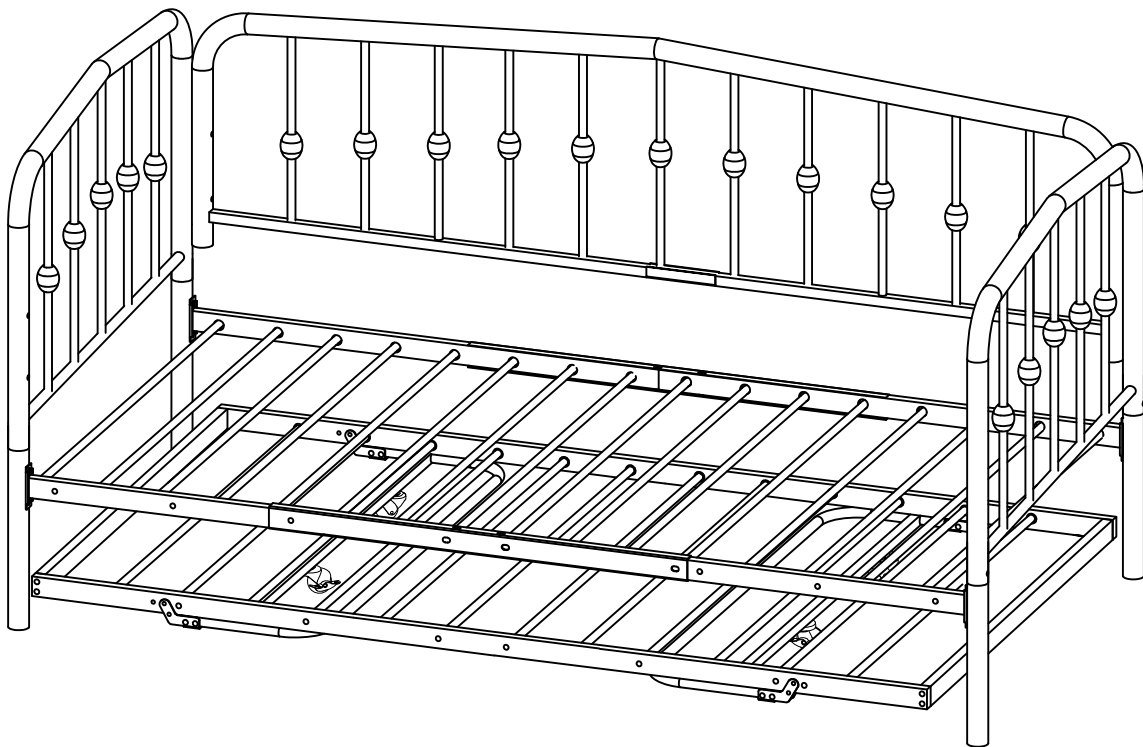

DEAR CUSTOMER,

Thank you for choosing our product. Please read this manual carefully before assembling or using the product, to avoid damage caused by improper use. If the product is passed on to third parties, this manual has to be passed on along with the product. For any question don't hesitate to contact us



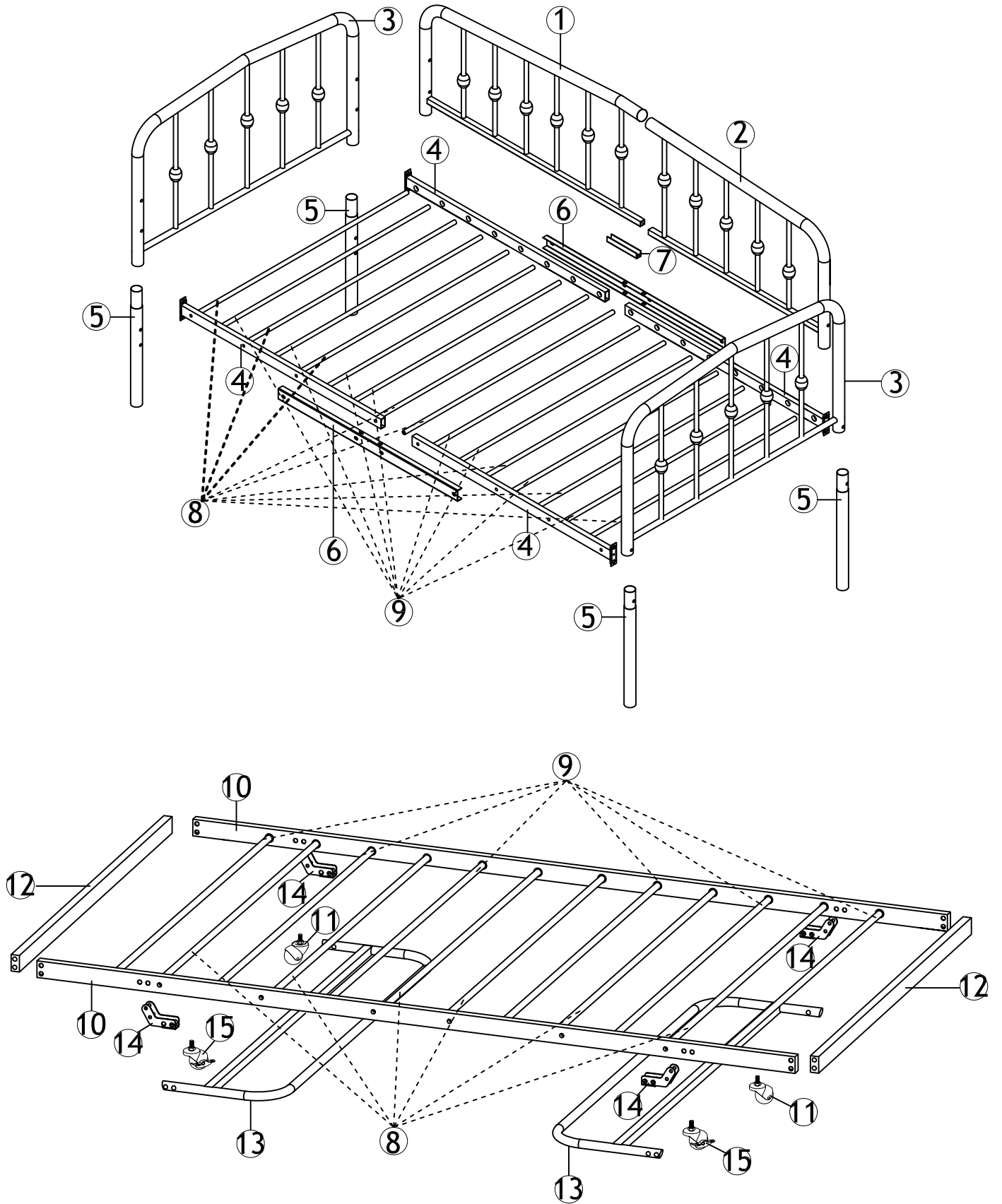

Lieber Kunde,

Vielen Dank für die Auswahl unseres Produkts. Bitte lesen Sie dieses Handbuch vor dem Zusammenbau oder der Verwendung sorgfältig durch. Das Produkt, um Schäden zu vermeiden, die durch einen unsachgemäßen Gebrauch verursacht werden. Wenn das Produkt an Dritte weitergegeben wird, Dieses Handbuch muss zusammen mit dem Produkt weitergegeben werden. Für jede Frage zögern Sie nicht zu kontaktieren

PARTS LIST

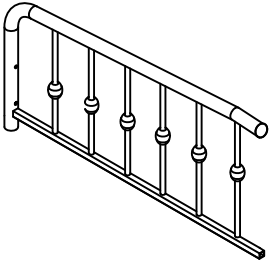
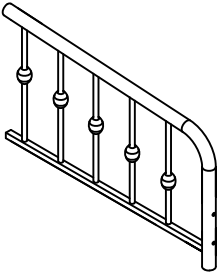
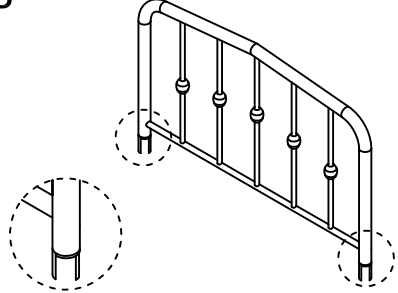
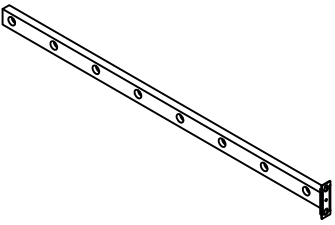
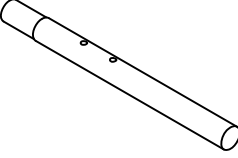
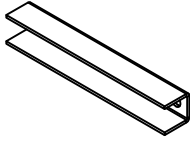

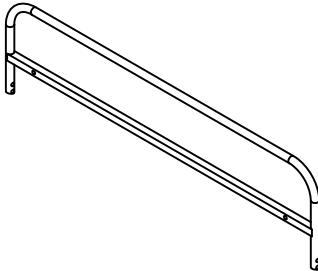
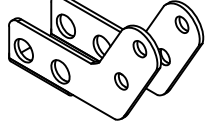



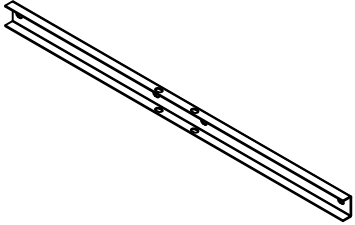
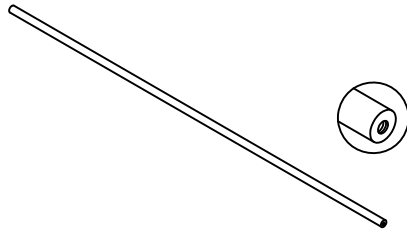
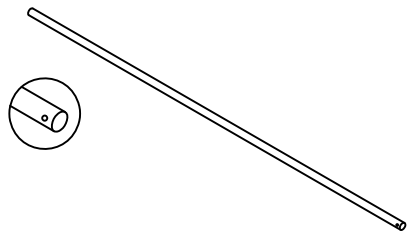
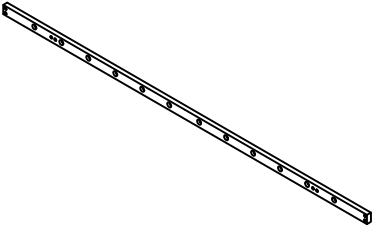
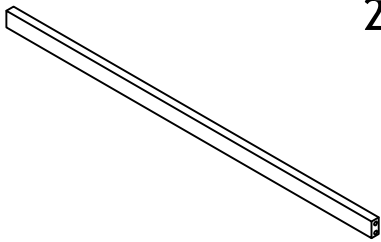

PARTS LIST FOR WF319422

<p>1</p> 	<p>1× 2</p> 	<p>1× 3</p> 	<p>2×</p>
<p>4</p> 	<p>4× 5</p> 	<p>4× 7</p> 	<p>1×</p>
<p>11</p> 	<p>2× 13</p> 	<p>2× 14</p> 	<p>4×</p>
<p>15</p> 	<p>2×</p>		

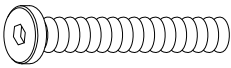
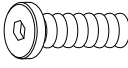
PARTS LIST FOR WF319423

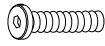
6 2x 	8 14x 	9 14x 
10 2x 	12 2x 	

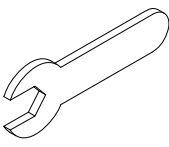
Hardware LIST FOR WF319422

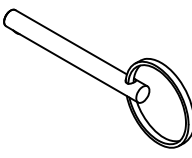
A 4×  M8×50mm	B 12×  M8×20mm	C 8×  M6×40mm
D 12×  M6×35mm	E 32×  M6×15mm	F 12× 
G 1×  M6	H 1×  M5	I 1×  M4
J 2× 		

ASSEMBLY

1

Before your installation, please make sure that you have all the parts listed on the manual. If you find something missing, stop installing and contact your supplier immediately.

Bitte stellen Sie vor Ihrer Installation sicher, dass Sie alle Teile haben. Auf dem Handbuch aufgeführt. Wenn Sie etwas fehlen, hören Sie auf zu installieren und wenden Sie sich sofort an Ihren Lieferanten.

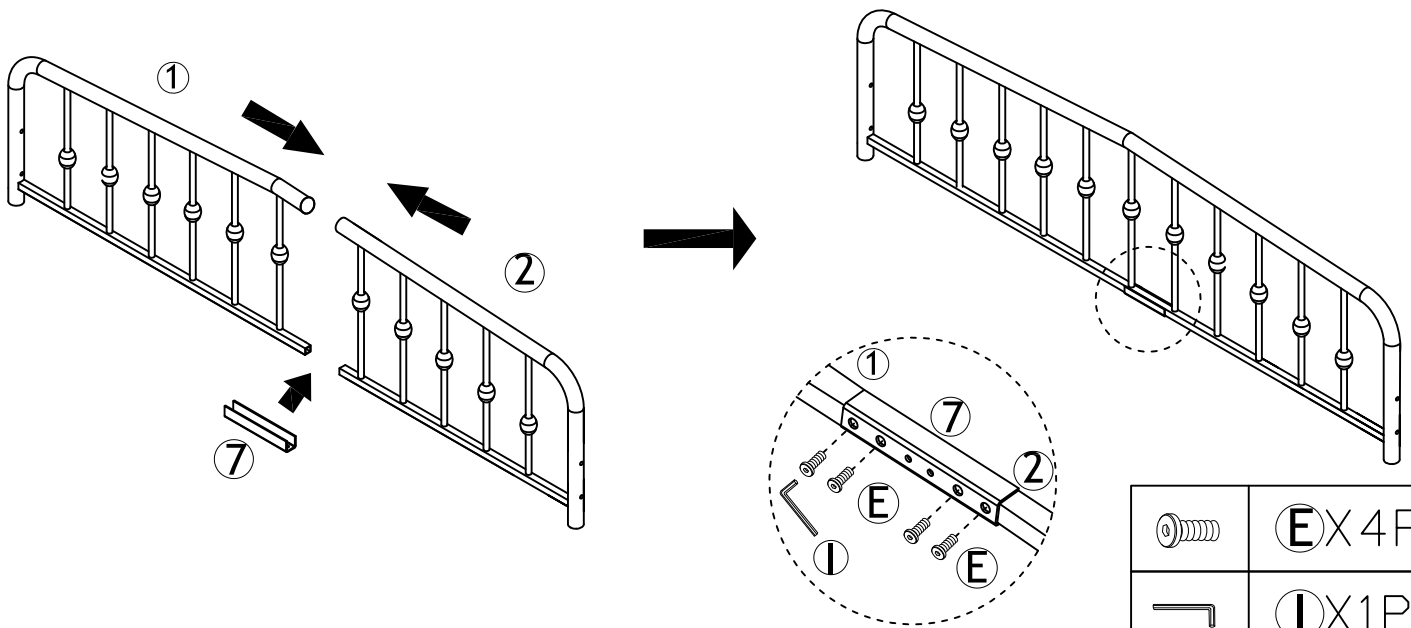

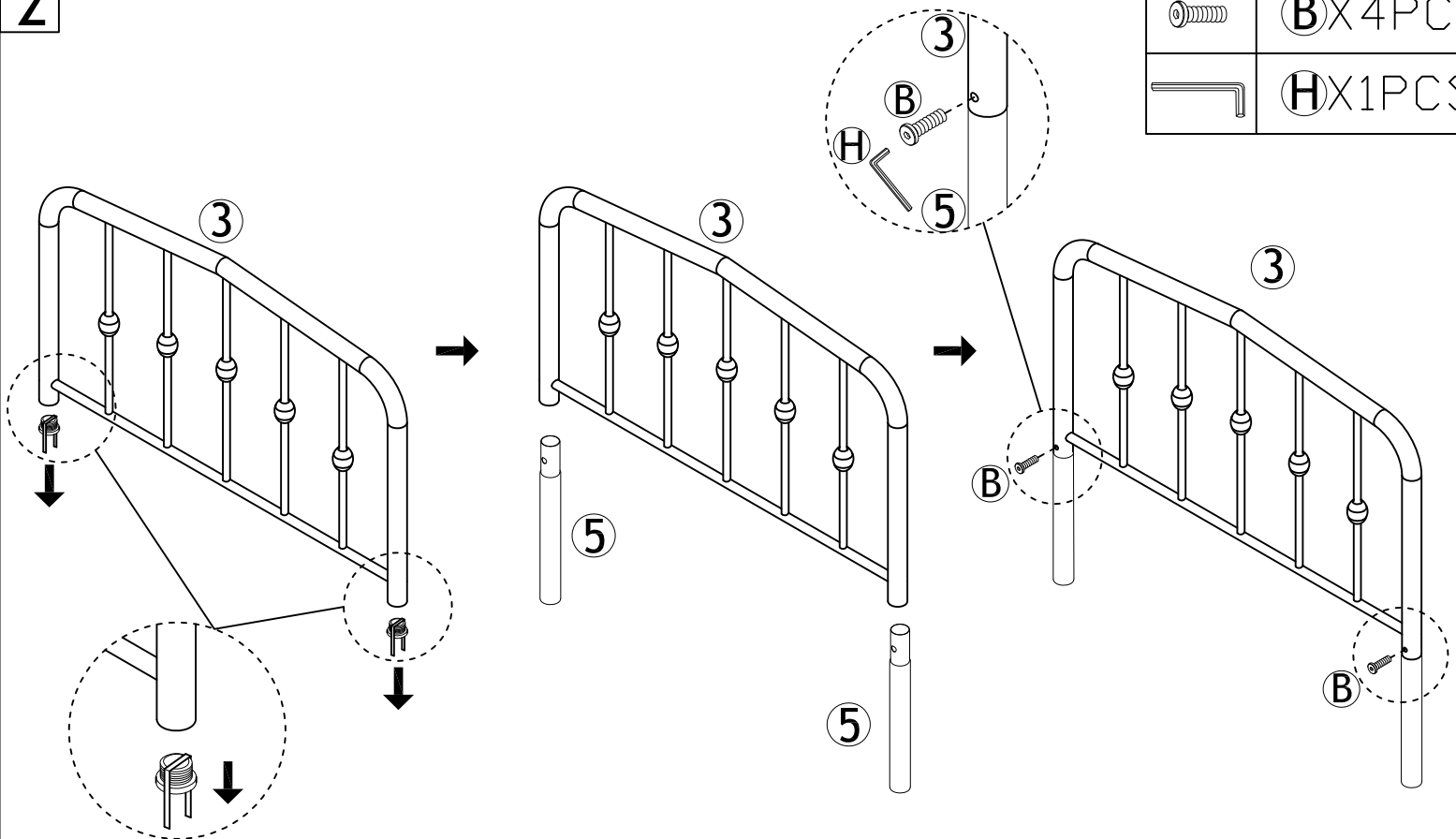

	E X4PCS
	I X1PCS
	B X4PCS
	H X1PCS

2



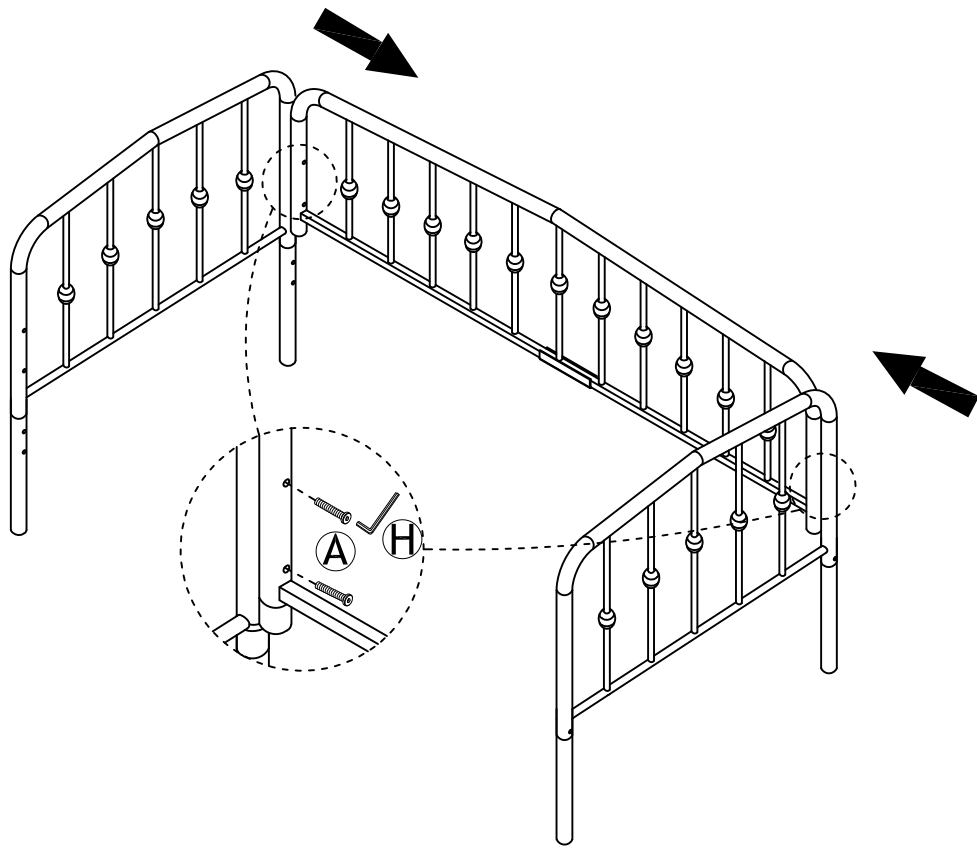

3

	A X 4 PCS
	H X 1 PCS



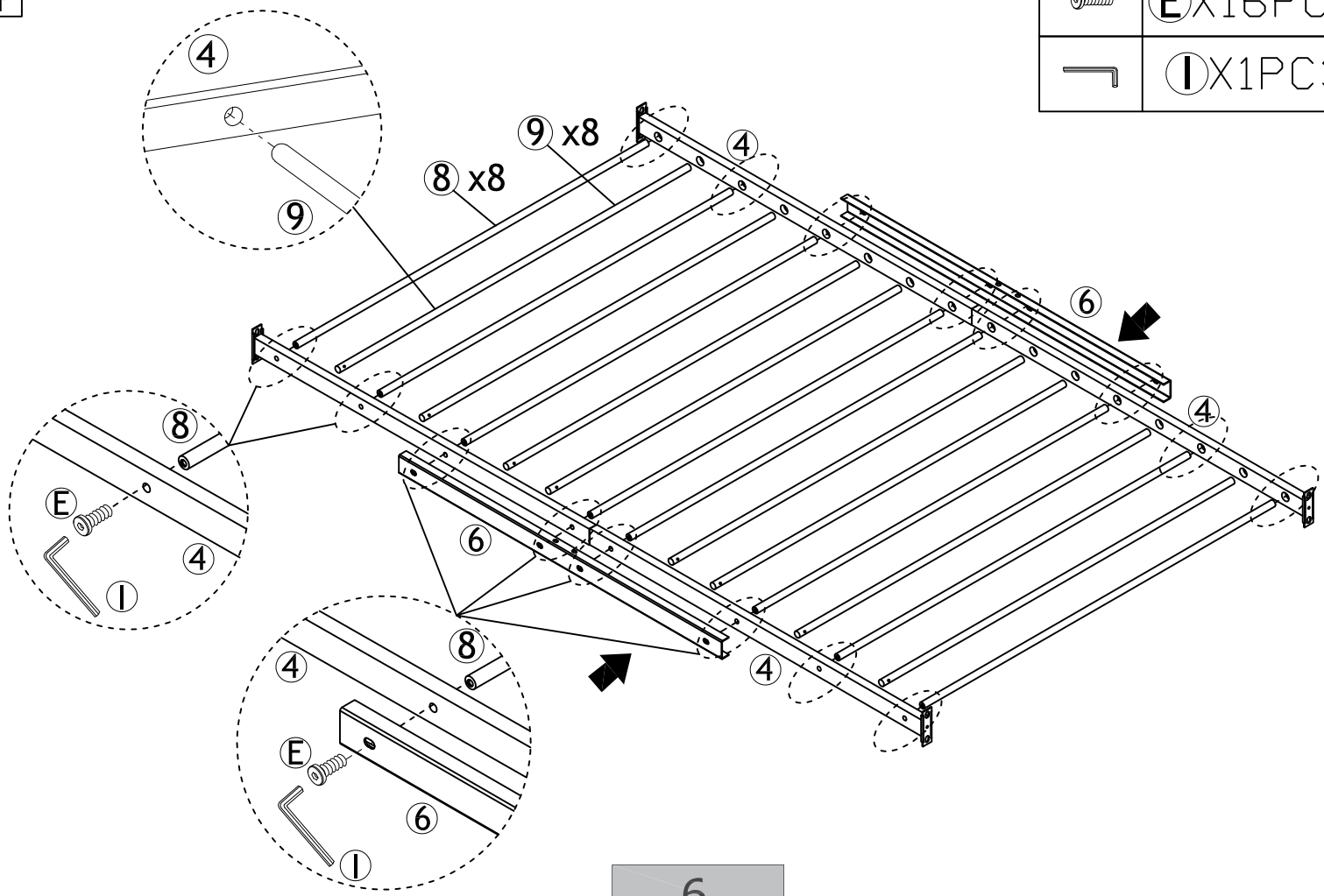

4

	E X 16 PCS
	I X 1 PCS





6

5

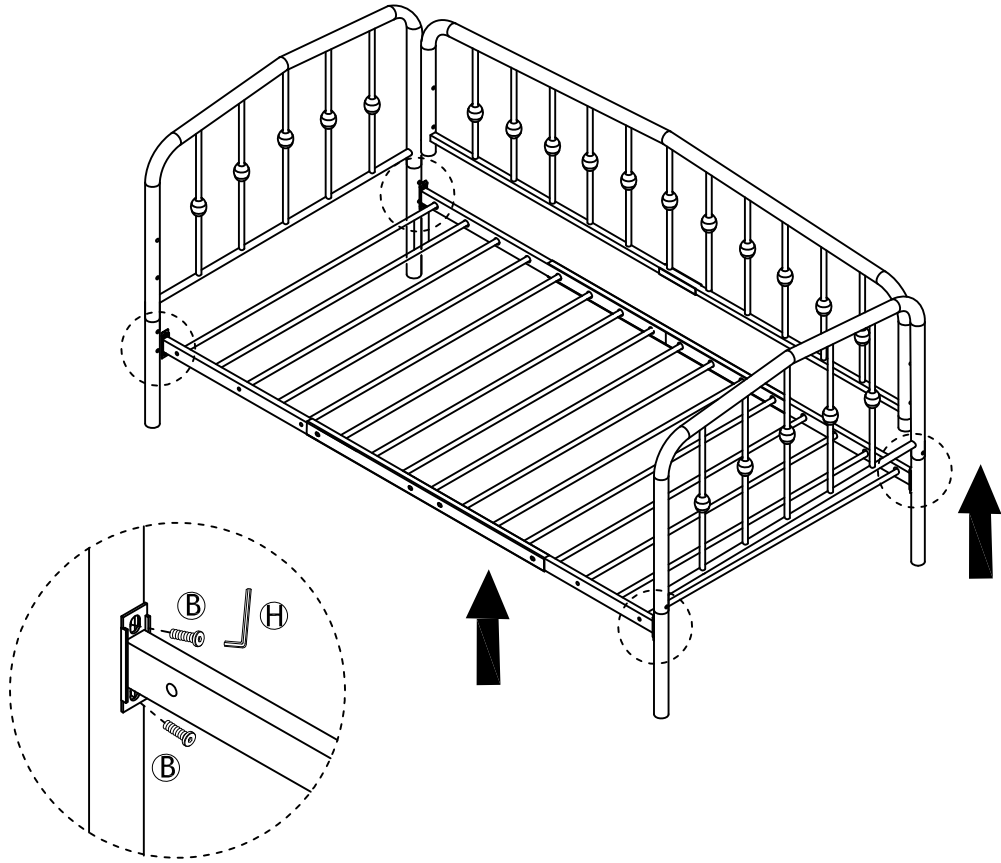
	B X8PCS
	H X1PCS



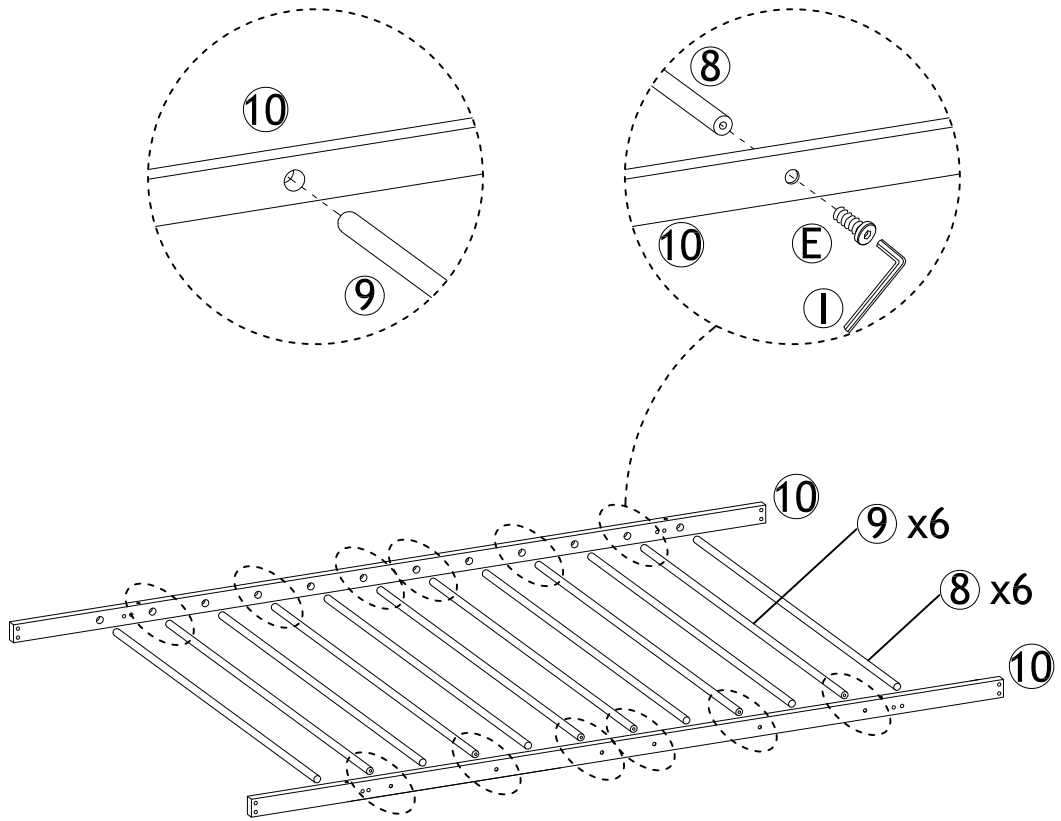

6

	E X12PCS
	I X1PCS





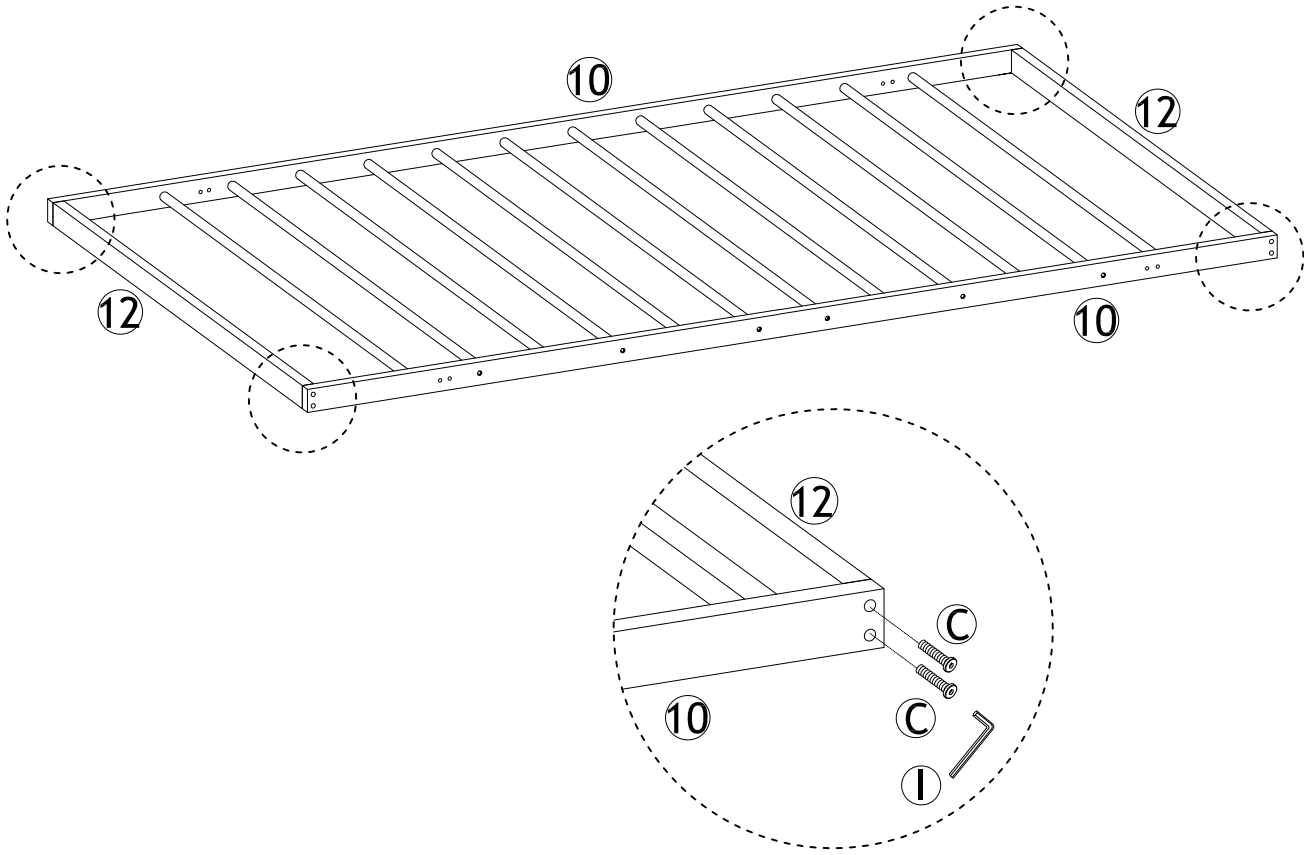

7

	C X8PCS
	I X1PCS





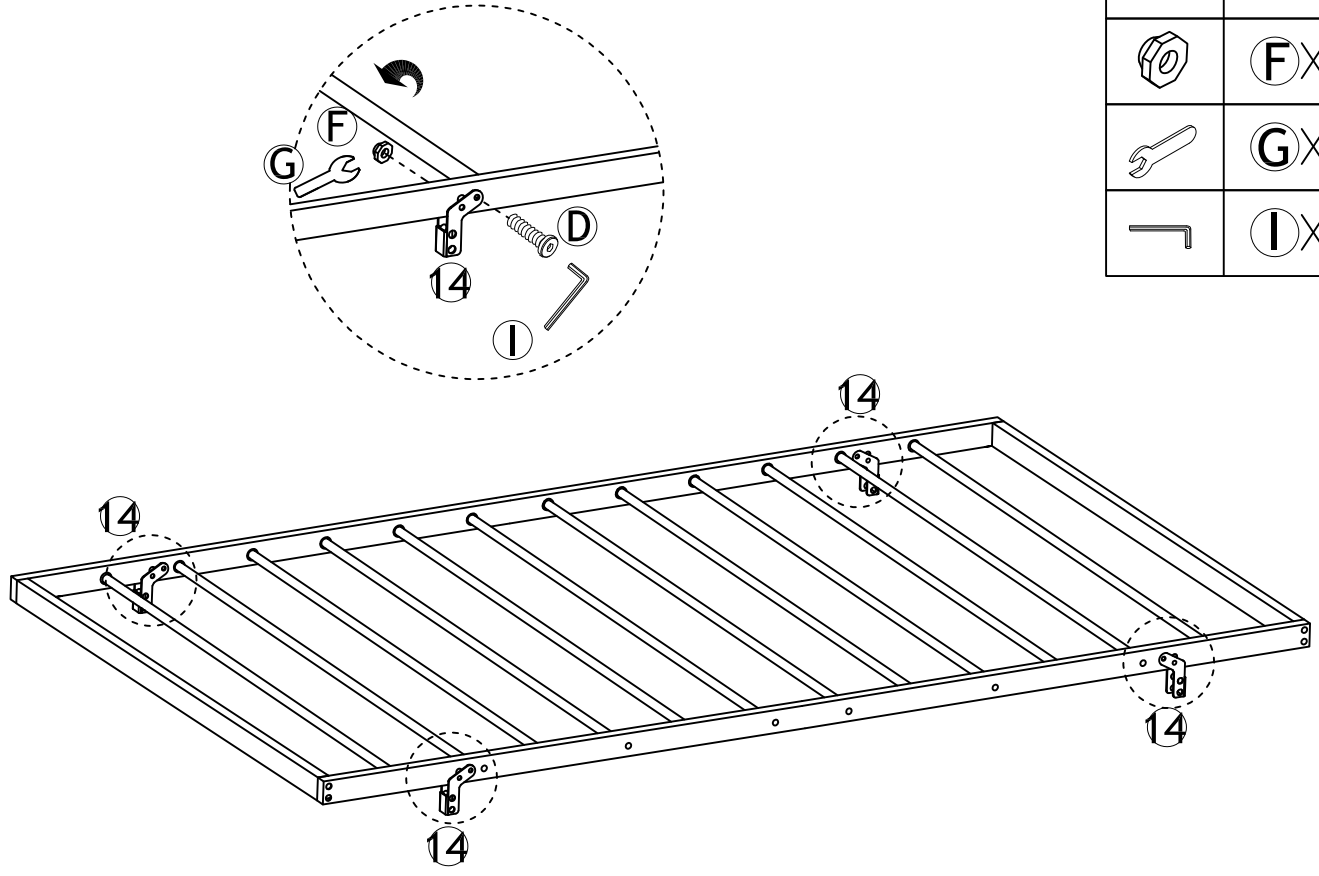

8

	D X4PCS
	F X4PCS
	G X1PCS
	I X1PCS





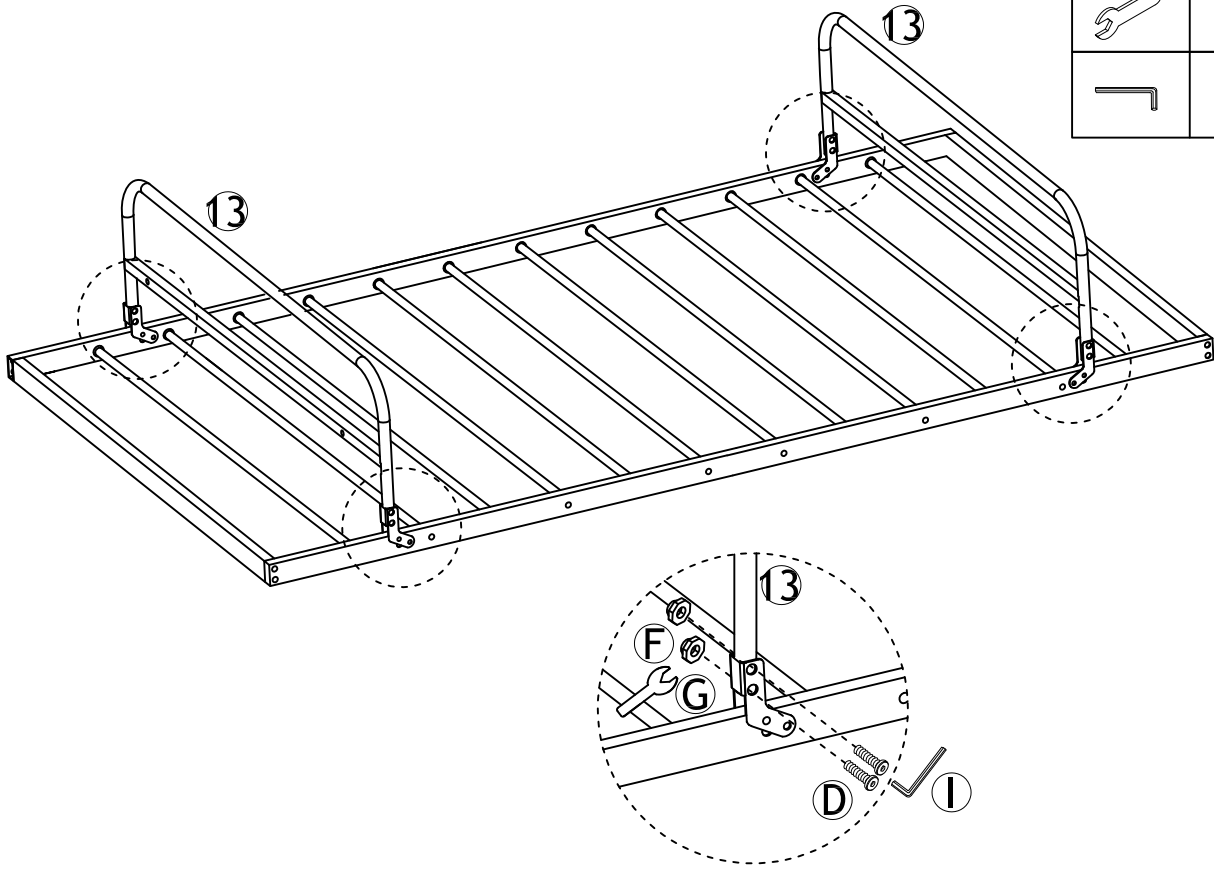

9

	D X8PCS
	F X8PCS
	G X1PCS
	I X1PCS



10

	J X2PCS
	15 X2PCS
	11 X2PCS
	G X1PCS

