

-02P2

Montageanweisung / Installation instructions / Instruction de montage / Istruzioni di montaggio
Montagehandleding / Instrukja montazù / Montaj talimatlar / Osszeszerelési útmutató / Nàvod k montáži /
Nàvod na montáž / Instructiune de montaj / Инструкция по монтажу / Montaj talimatina

AMALFI

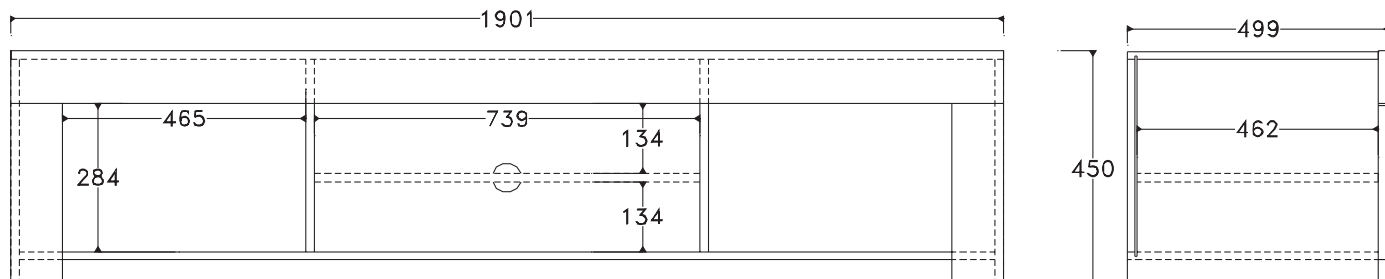
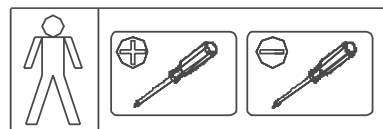

D Bitte lesen Sie diese Montageanleitung gut durch, da wir für Fehler, die durch falsche Montage entstehen, keine Haftung übernehmen!

GB Please read these installation instructions through carefully as we cannot accept any liability for faults occurring as a result of incorrect installation!

CZ Přečtěte si prosím pozorně tento návod k montáži, aby jste předešli chybám vzniklých špatnou montáží, za které neručíme!

F Veuillez lire attentivement cette notice de montage, car nous déclinons toute responsabilité en cas d'erreurs découlant d'un montage erroné !

I Prego leggere attentamente le istruzioni per il montaggio, poiché decliniamo qualsiasi responsabilità per difetti derivanti da un montaggio errato

NL Leest u alstublieft deze montagehandleiding goed door, voor fouten door verkeerde montage zijn wij niet verantwoordelijk.

PL Proszę uważnie zapoznać się z instrukcją montażu, ponieważ nie ponosimy odpowiedzialności za niewłaściwy montaż.

HU Kérjük, olvassa el figyelmesen ezt az összeszerelési útmutatót, mert a helytelen összeszerelésből a dódó hibákért nem vállalunk felelősséget!

SK Prosíme, dobre prečítajte si tento návod na montáž, pretože nepreberáme žiadne ručenie za chyby, ktoré vzniknú na základe chýbnej montáže!

RO Vă rugăm să citiți cu atenție aceste instrucțiuni de montaj deoarece nu preluăm garanția pentru defecte ce apar datorită unui montaj incorect!

RUS Пожалуйста, внимательно ознакомьтесь с данной инструкцией по монтажу, поскольку мы не несем ответственности за ошибки, причиной которых является неправильный монтаж.

TU İlkonce kullanma klavuzunu iyi okuyun, yanlış montaj yaparsanız bunun sorumlusu biz degiliz.

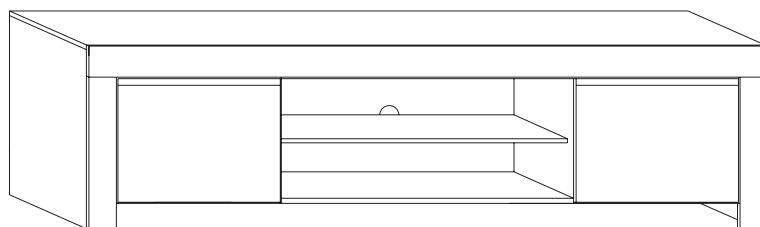

LC S.p.A
Via del Piano s.n
61030 Isola del Piano (PU)
Italia

Total Kollis 3 Stuecke
Total colli 3 pieces
Numero total des colis: 3
Colli totali 3
Total 3 colli's
Razem sztuk 3
Toplam parçalar 3
Celkem baličky 3
Teljes csomag 3
Celkom baličky 3
количество Всего 3
Total colete 3

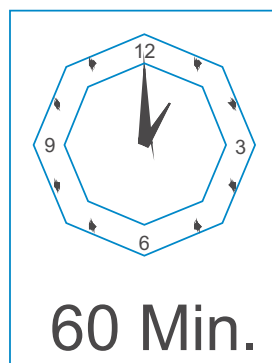



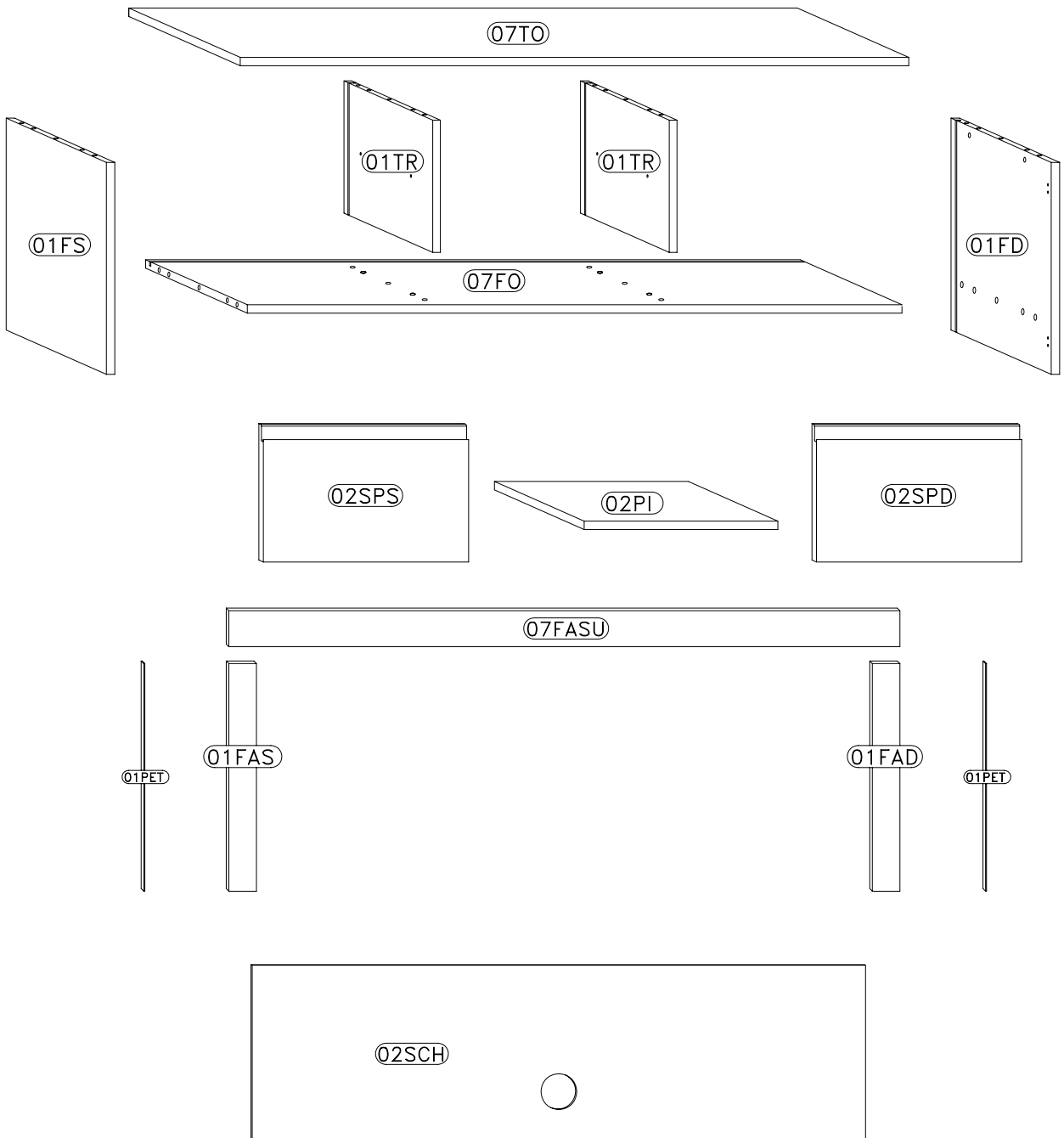
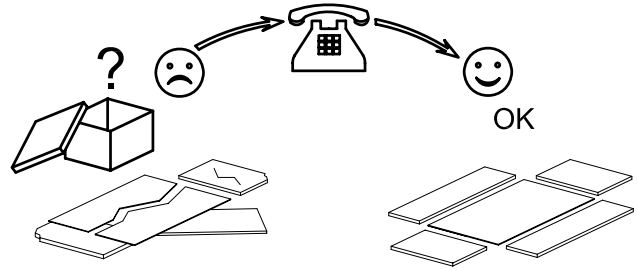
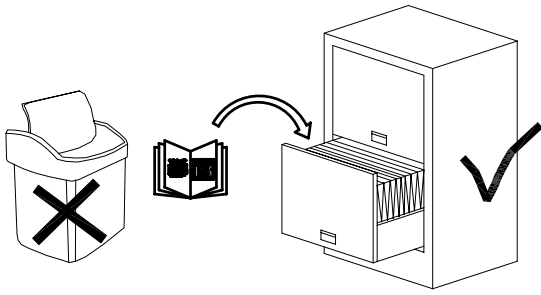

S E R V I C E K A R T E

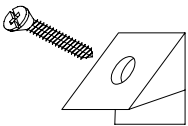

ONDERDELEN LYST-SERVICEKARTE-FORMULAIRE DEMANDES SAV-SPAREPARTS LIST-SCHEDA DI SERVIZIO

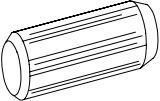
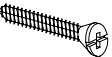
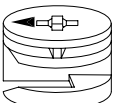
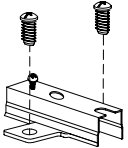
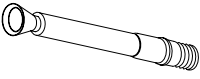
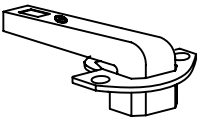
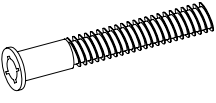
BESLAG-BESCHLAEGE - QUINCALLERIE - HARDWARE - FERRAMENTA

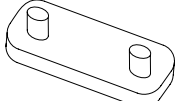
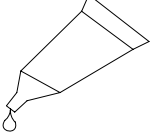
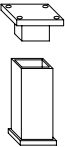
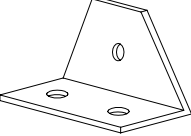
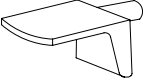
<p>A</p>  <p>x12</p>	<p>L2</p>  <p>4x16 mm.</p> <p>x16</p>
<p>B</p>  <p>8x30 mm.</p> <p>x28</p>	<p>L3</p>  <p>4x18 mm.</p> <p>x24</p>
<p>C</p>  <p>∅16 mm.</p> <p>x12</p>	<p>N1</p>  <p>x4</p>
<p>D</p>  <p>x12</p>	<p>O1</p>  <p>x4</p>
<p>E1</p>  <p>5x50 mm.</p> <p>x4</p>	<p>P</p>  <p>x2</p>
<p>F1</p>  <p>x4</p>	<p>P1</p>  <p>x2</p>
<p>F2</p>  <p>x2</p>	<p>P7</p>  <p>x8</p>
<p>R</p>  <p>x4</p>	

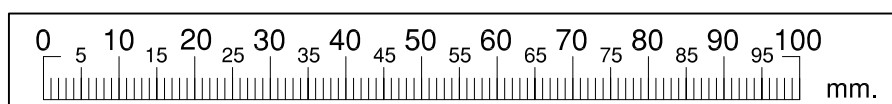

1

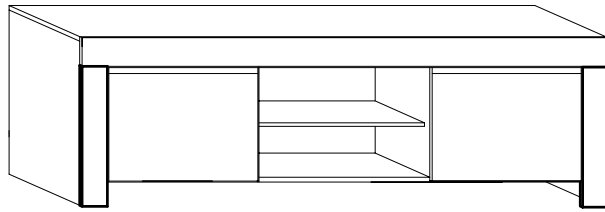
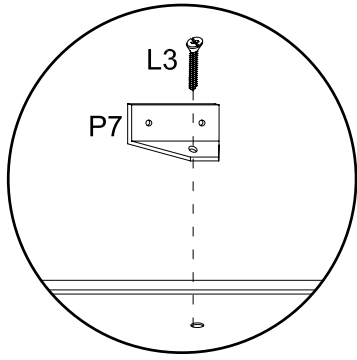

- L3 4x18 mm. x4
- N1 x4
- P7 x4

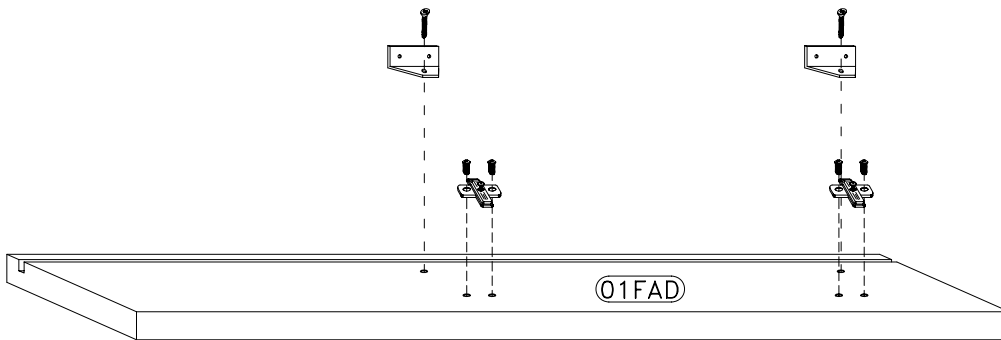
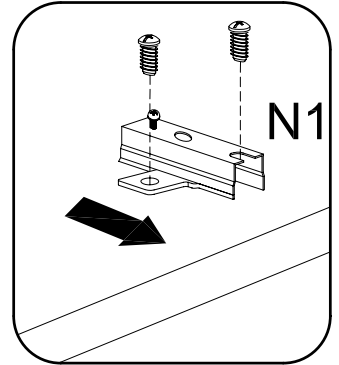
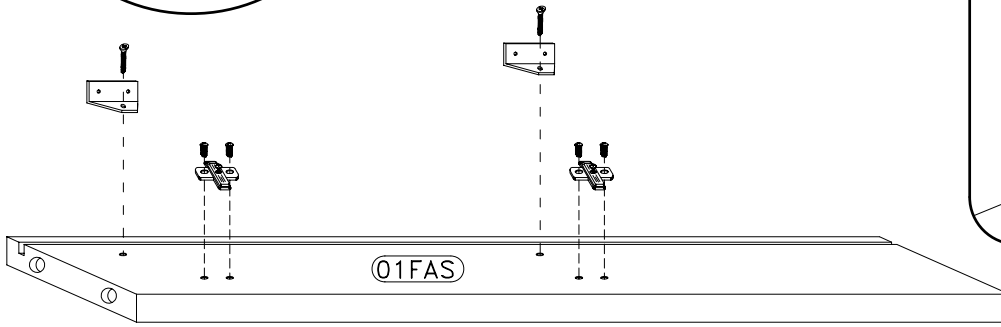

2

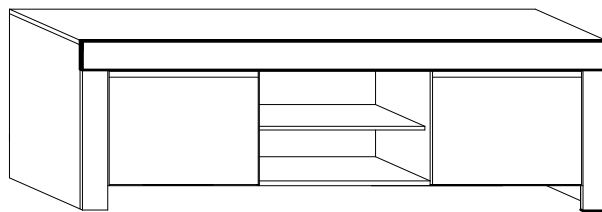
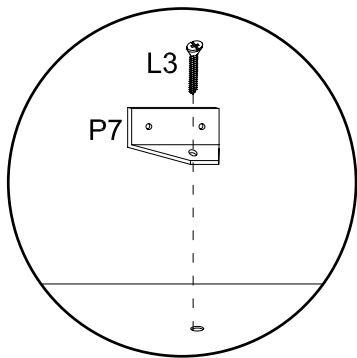

- L3 4x18 mm. x4
- P7 x4

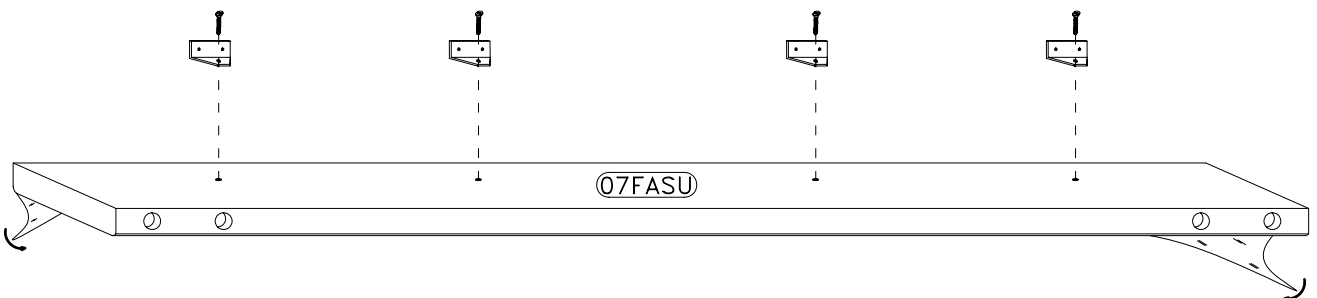

3

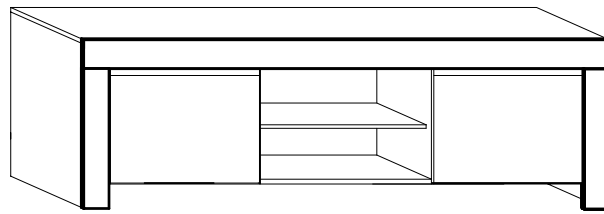

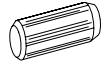

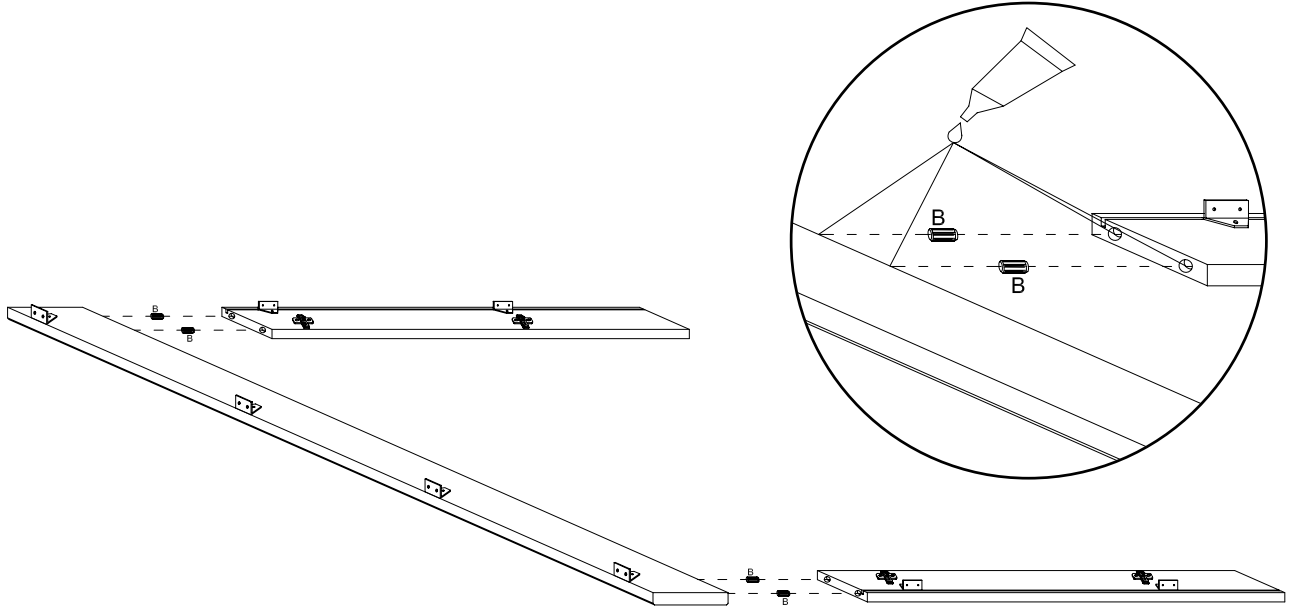
B		x4
8x30 mm.		

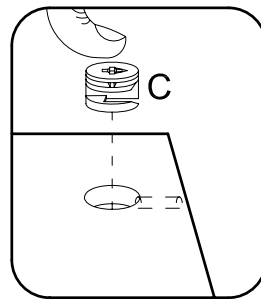
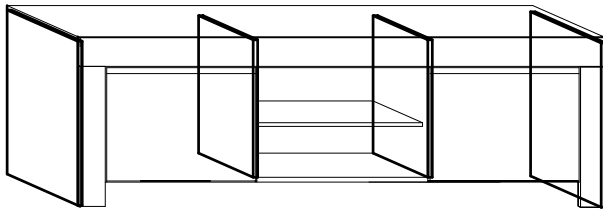

4



B		x18
8x30 mm.		
C		x8
ø16 mm.		
F1		x4

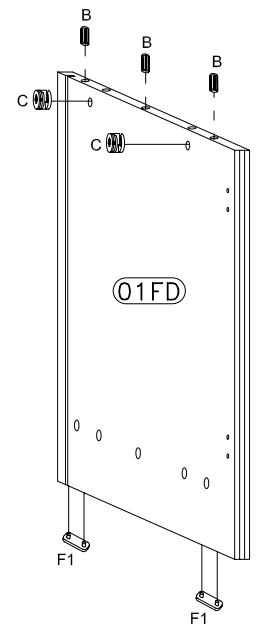
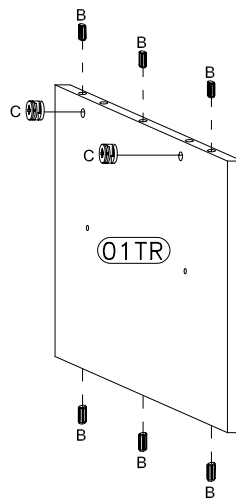
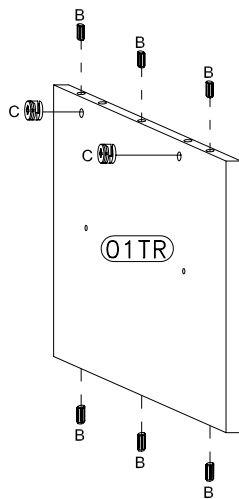
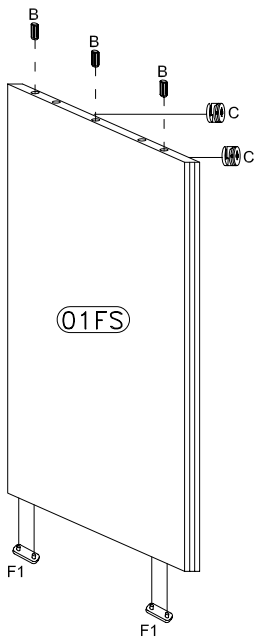

5

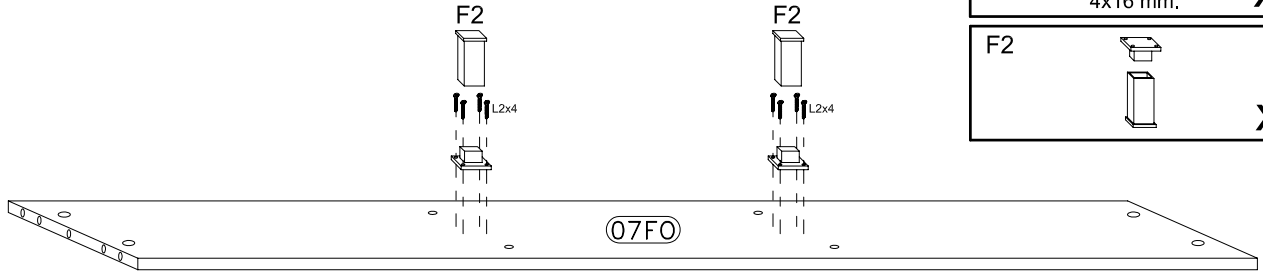

- | | | |
|----|--|----|
| L2 | | x8 |
| F2 | | x2 |

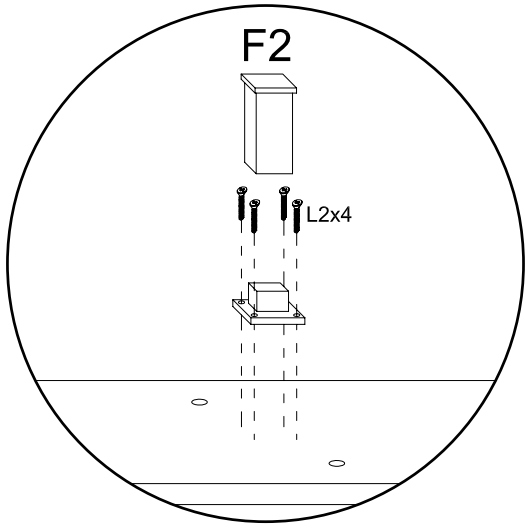

6

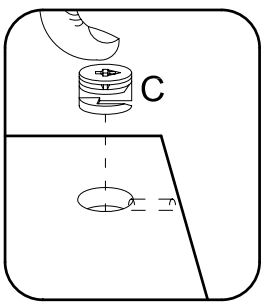
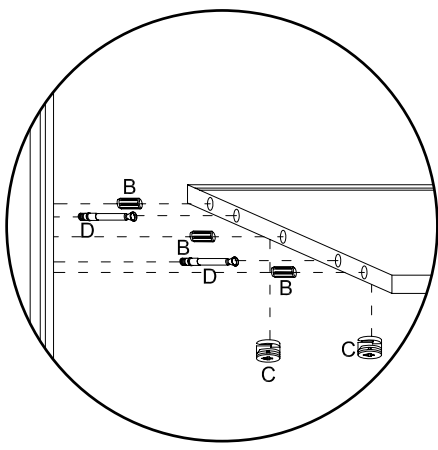

- | | | |
|----|--|----|
| D | | x4 |
| B | | x6 |
| E1 | | x4 |
| C | | x4 |

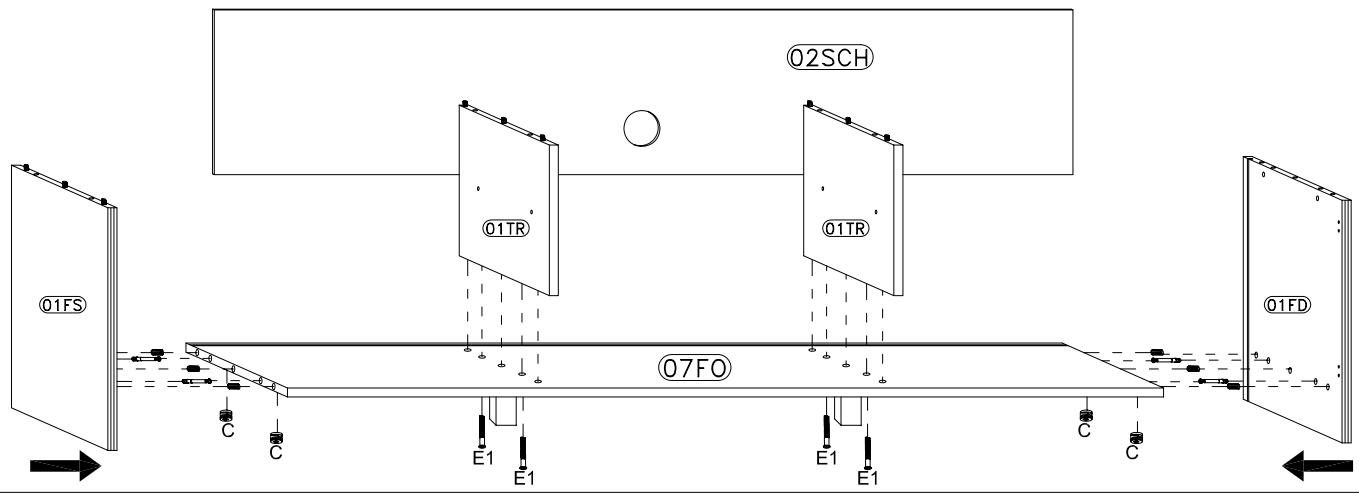
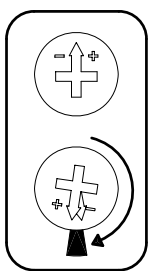
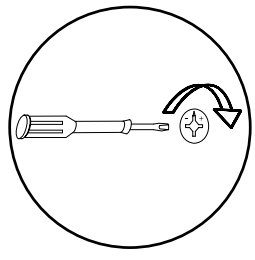

7

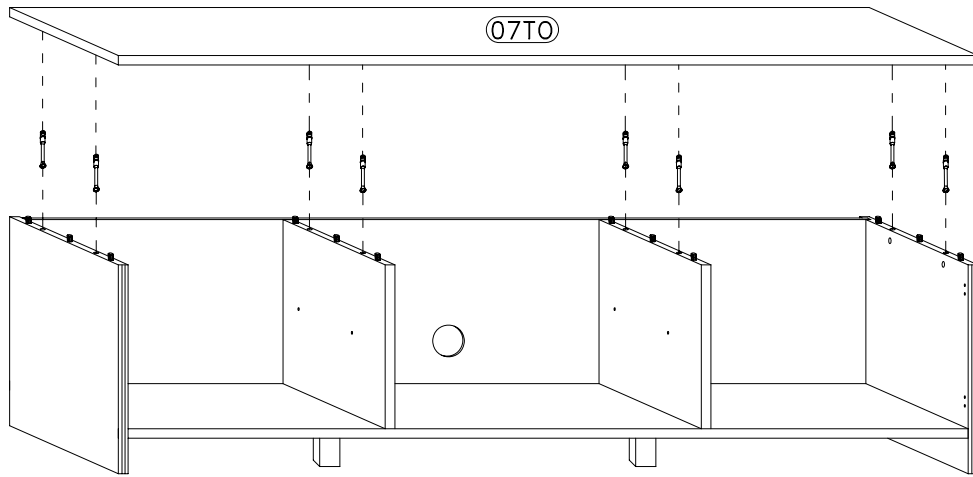
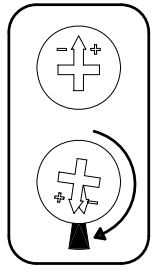
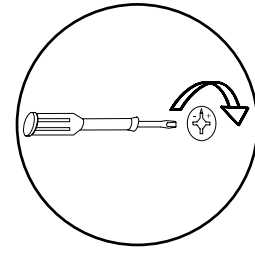
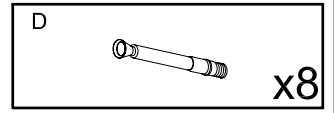
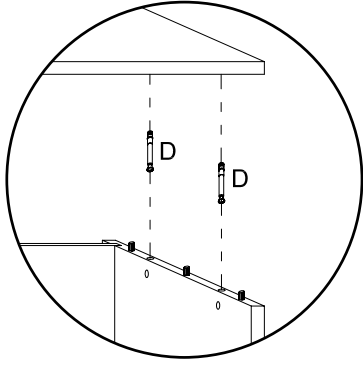

8

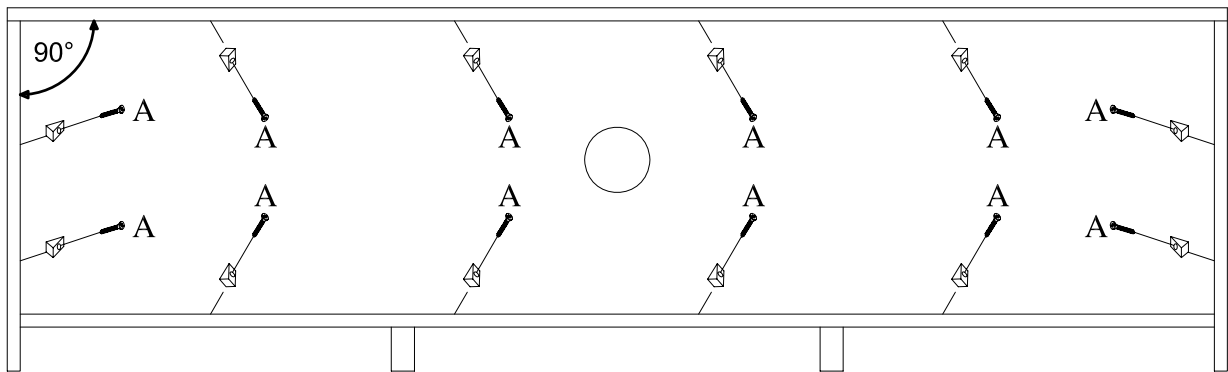
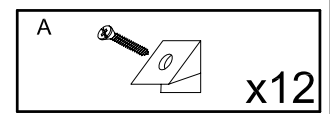
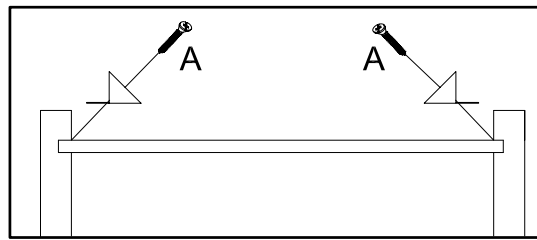

7

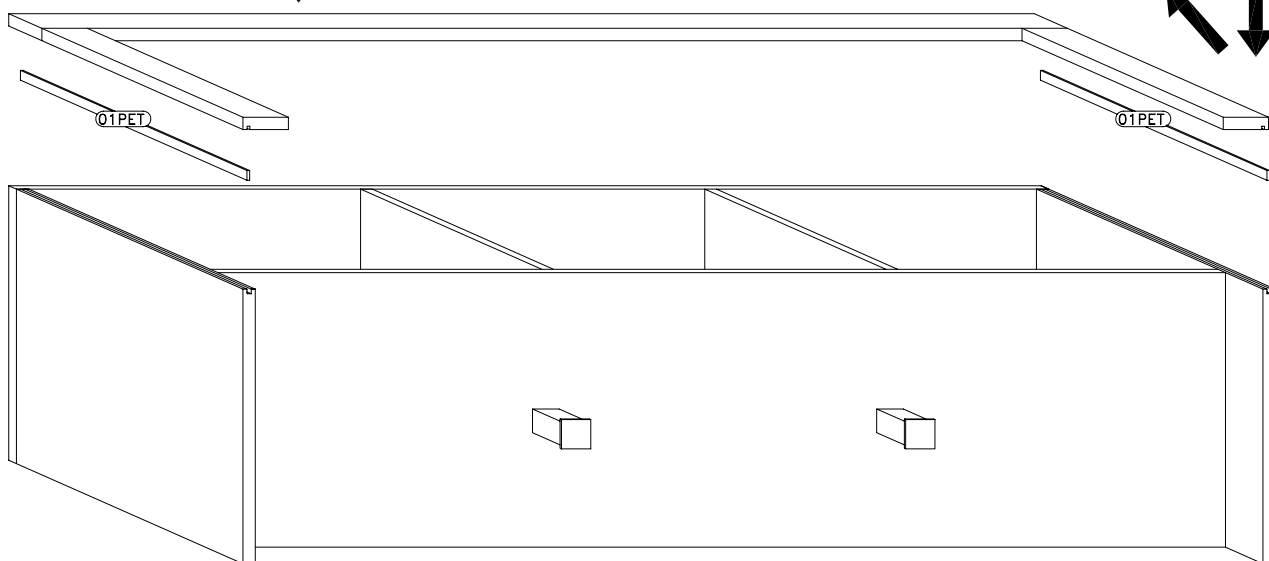
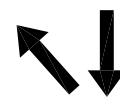
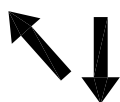
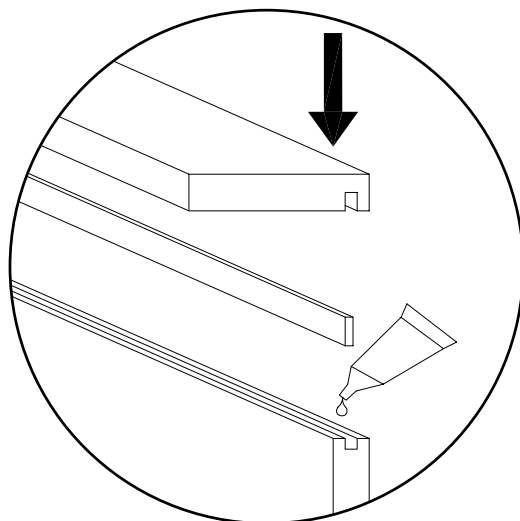

9

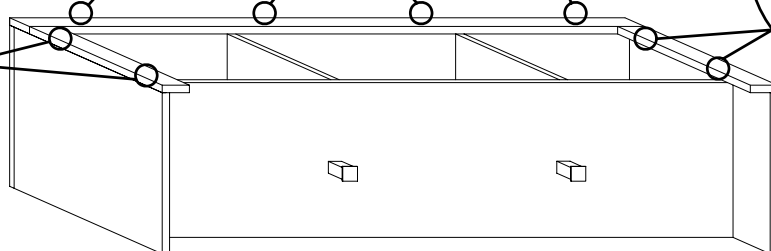
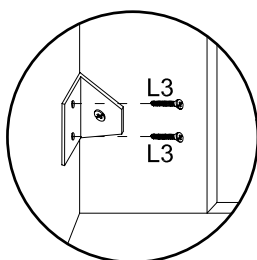
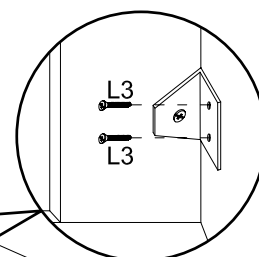
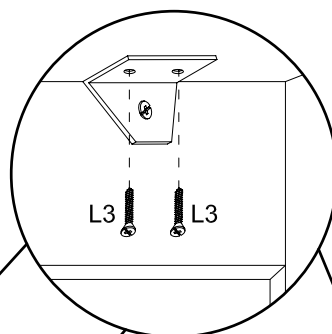
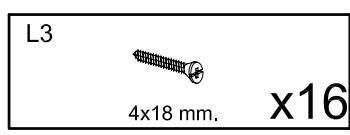

10

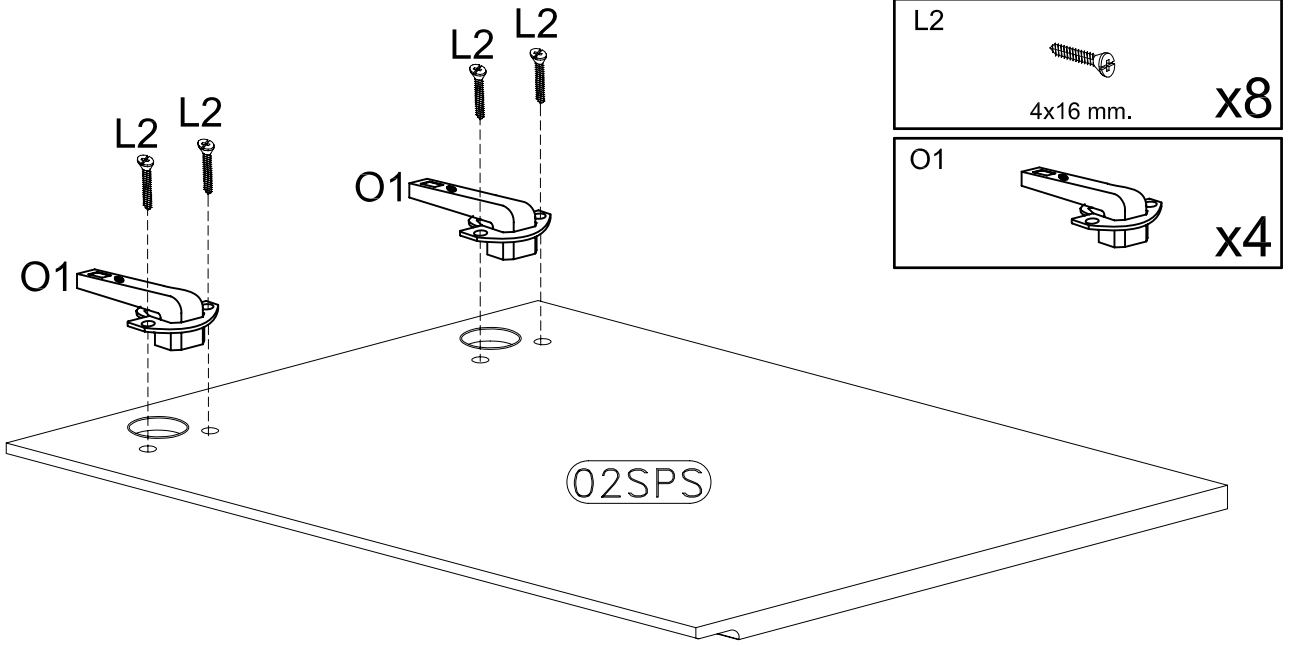

11

