

Paul Neuhaus

Paul Neuhaus GmbH

Olakenweg 36 · D-59457 Werl

+49(0)2922 9721 9290

Kundenservice@neuhaus-group.de

www.paul-neuhaus.de



D | Montageanleitung • GB | Fitting instruction

**DE** Dieses Produkt enthält eine Lichtquelle der Energieeffizienzklasse <E>.

**GB** This product contains a light source of energy efficiency class <E>.

**FR** Ce produit comprend une source de lumière de classe d'efficience énergétique <E>

**ES** Este producto contiene una fuente de luz de la clase de eficiencia energética <E>.

**HR** Ovaj proizvod sadrži izvor svjetlosti energetskeg razreda <E>.

**HU** Ez a termék <E> energiahatékonysági osztályba tartozó fényforrást tartalmaz.

**IT** Questo prodotto contiene una sorgente luminosa della classe di efficienza energetica <E>.

**NL** Dit product bevat een lichtbron van energie-efficiëntieklasse <E>.

833602

230V/50Hz~  
1x LED-Board 24V DC / 27W  
nicht wechselbar / not changeable

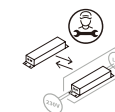

	27 W
	3.250 lm
	33 W
	1.150 lm
	LED-Board
<b>t</b>	20.000 h
<b>Tk</b>	2.700-5000 K
	15.000 x
	< 0,5 s



- 2x
- 2x
- 1x
- 1x



Inkl. IR-Fernbedienung  
Incl. IR remote control



### 1 | Montage / fitting

als Pendelleuchte  
as pendant light

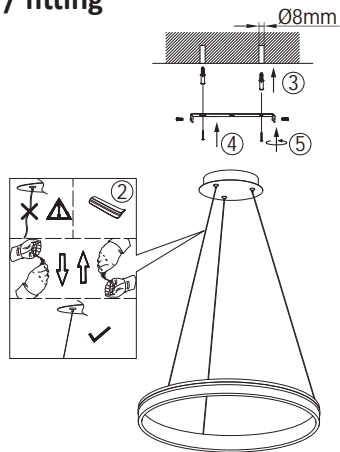
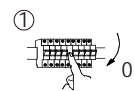

### 2 | Elektrischer Anschluss/ electrical connection

230Volt/50Hz-Anschluss  
230 voltage/50 Hz connection

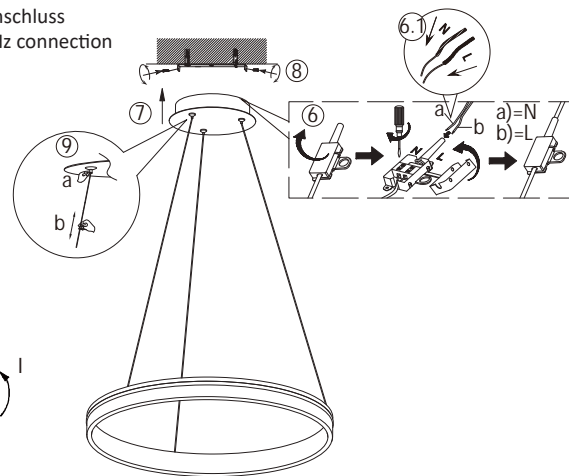
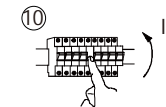

### 3 | Fernbedienung / remote control

Siehe Q-Fernbedienungsanleitung  
See Q-remote control manual

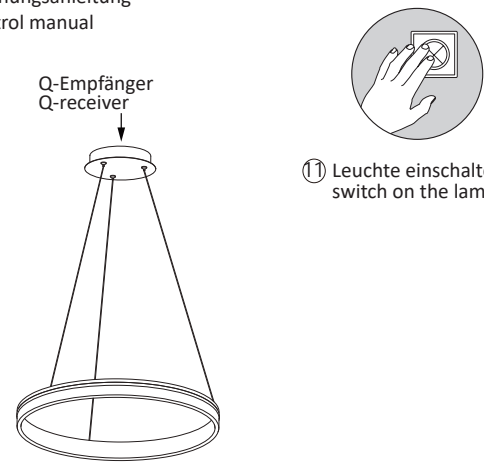

11 Leuchte einschalten  
switch on the lamp

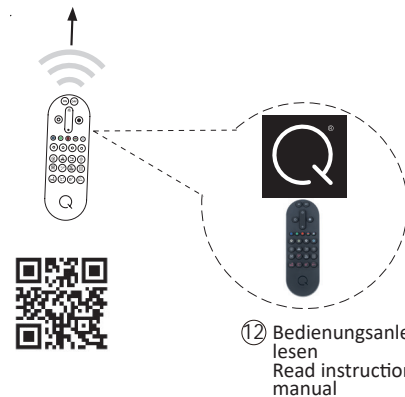

12 Bedienungsanleitung lesen  
Read instruction manual

### Reset

Zur Einbindung in ein ZigBee Netzwerk, stellen Sie die Leuchte auf Werkseinstellungen zurück.

To integrate the lamp into a ZigBee network, reset the lamp to the factory setting.

5x on/off

