

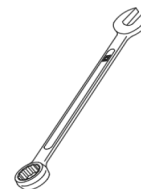

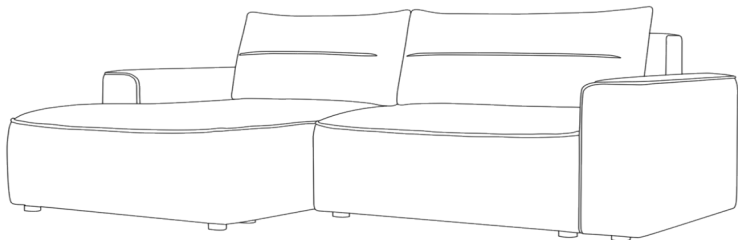





NOTICE DE MONTAGE  
 ASSEMBLING INSTRUCTIONS  
 ISTRUZIONI DI MONTAGGIO  
 MONTAGEANTEILUNG  
 ISTRUÇÕES DE MONTAGEM  
 MANUAL DE MONTAJE  
 SASTAVLJANJE UPUTE

# BELLUNO

## 2024/04/08



 <b>A</b> $\ominus 4,5 \times 45 \text{ mm}$ <b>x14</b>	 <b>B</b> 3 cm <b>x14</b>	 <b>C</b> $\varnothing 10 \text{ mm}$ <b>x14</b>	 <b>D</b> $\varnothing 3,5 \times 35$ <b>x6</b>	 <b>E</b> $\varnothing 8 \times 50$ <b>x2</b>	 <b>F</b> $\varnothing 8 \text{ mm}$ <b>x2</b>	 <b>G</b> $\varnothing 8 \text{ mm}$ <b>x2</b>
--	---	--	---	---	--	--

AVANT DE COMMENCER, SE  
 REPORTER AUX CONSEILS  
 DE MONTAGE EN ANNEXE

BEFORE STARTING REFER  
 TO THE ASSEMBLING ADVICE  
 IN ANNEX

AVANTI DI COMMINCIARE  
 RIPORTATE AGLI CONSIGLI DI  
 MONTAGGIO

VOR DIE MONTAGE, BITTE  
 BEILIEGENDE ANWEISUNGEN  
 FOLGEN

ANTES DE COMERCAR, ADIARSE  
 AOS CONSELHOS DE  
 MONTAGEM EM ANEXO

ANTES DE EMPEZAR  
 CONSULTE LOS CONSEJOS  
 PARA EL MONTAJE

PRJE POČETKA OBRATITE  
 U okupljanje savjet u DODATKU

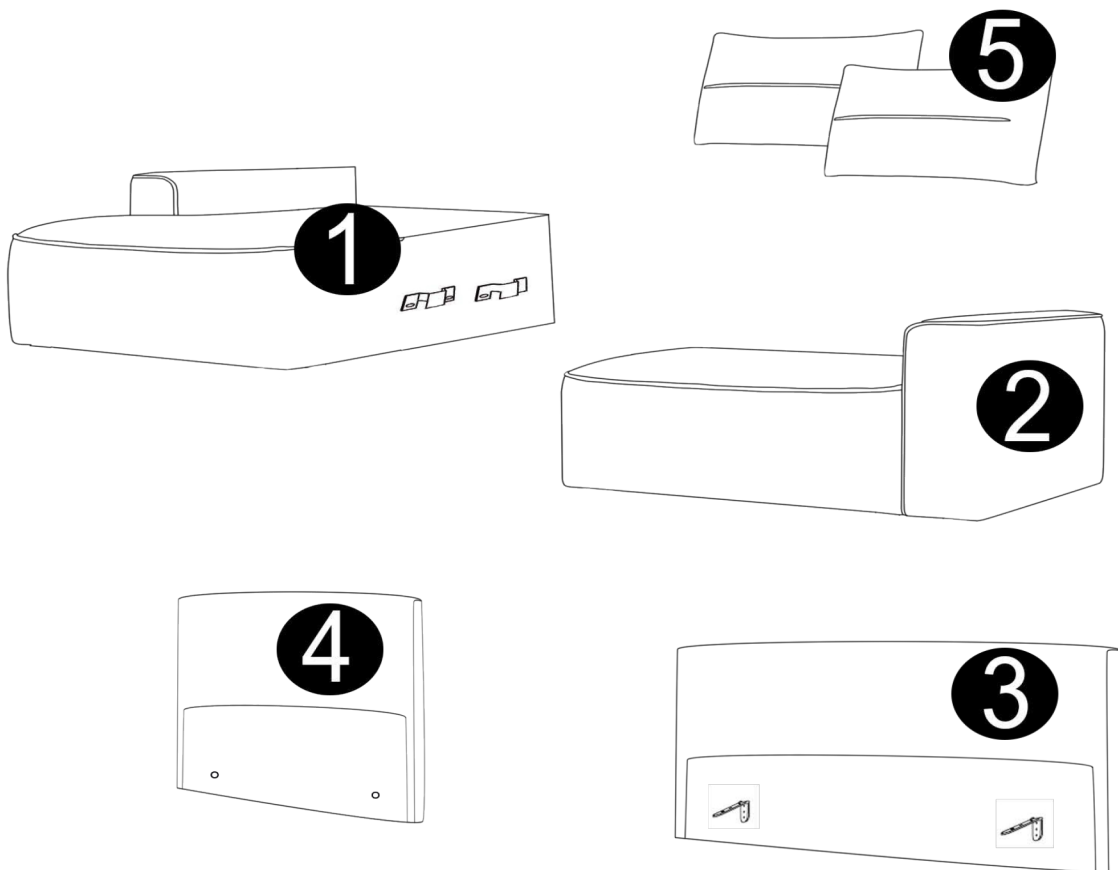

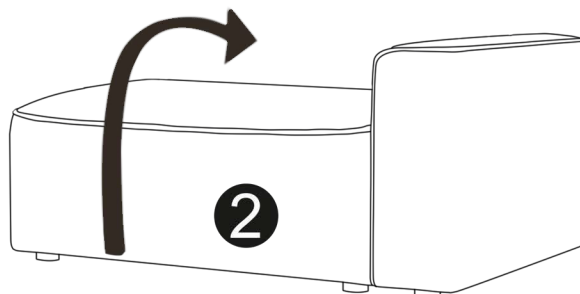
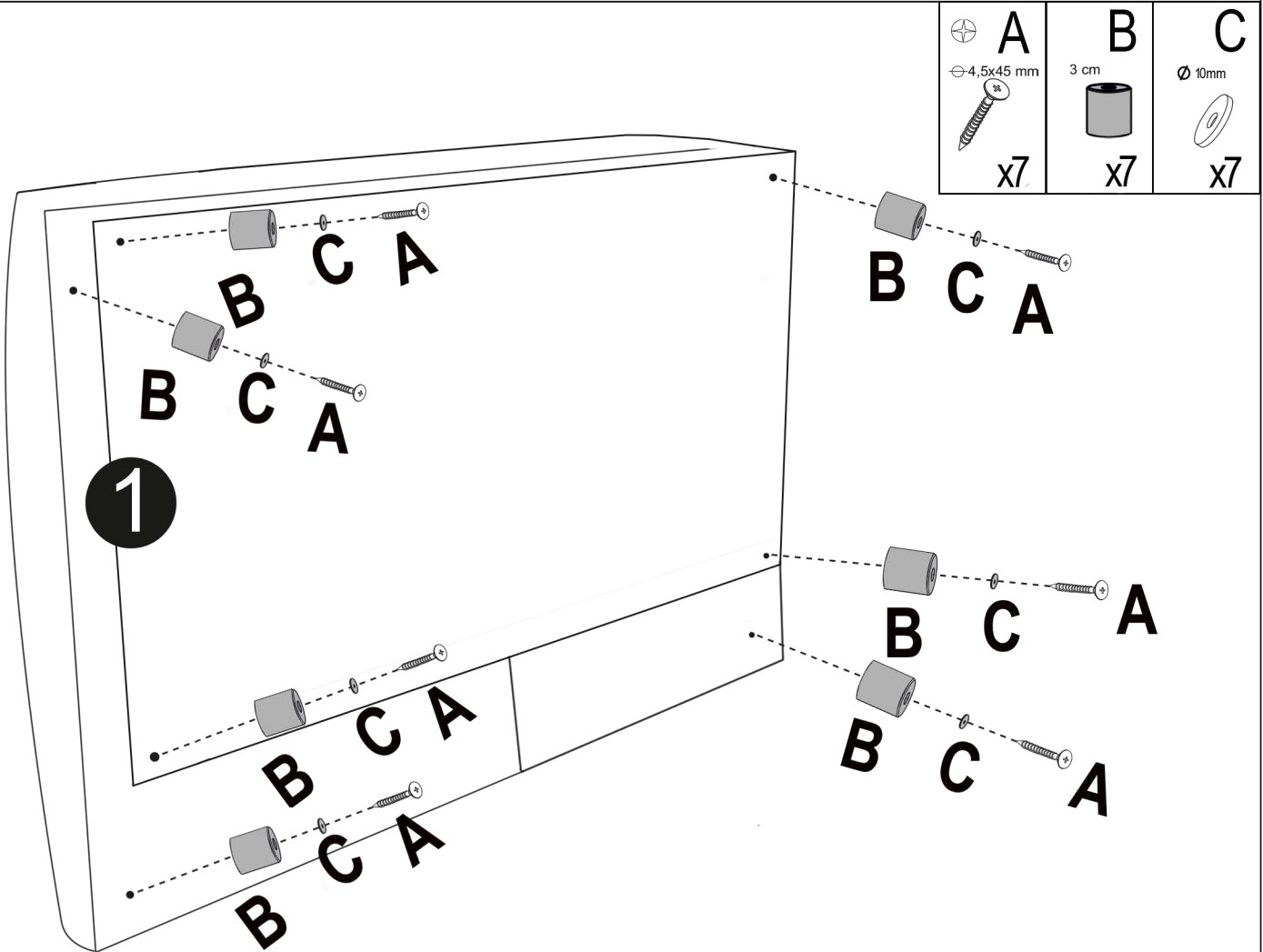
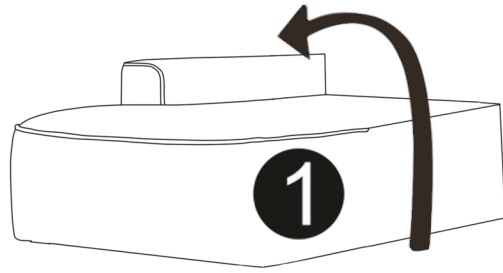

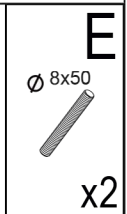
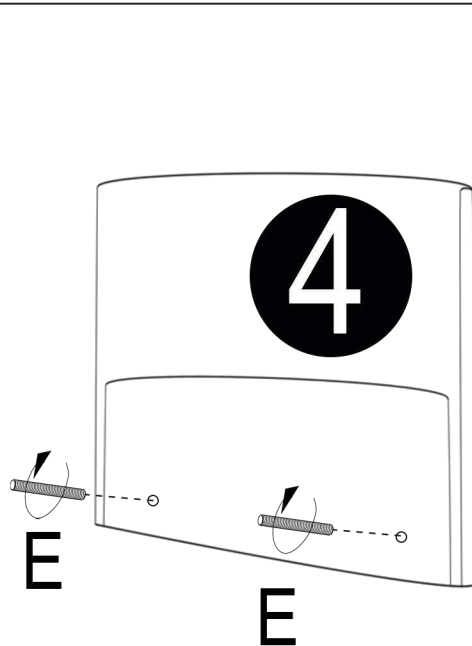
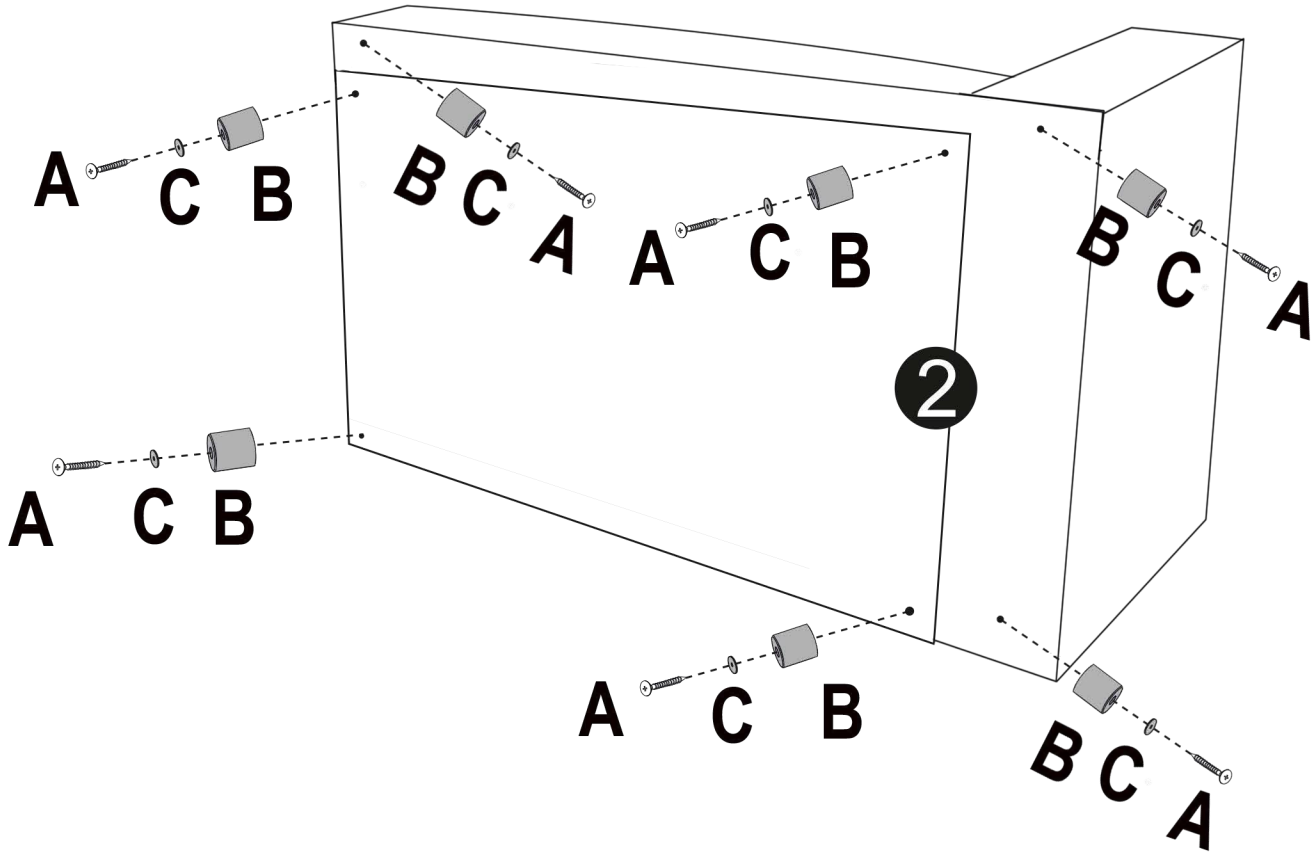
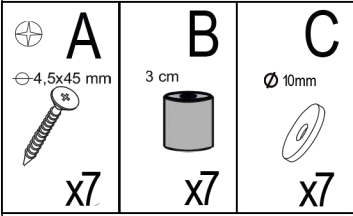

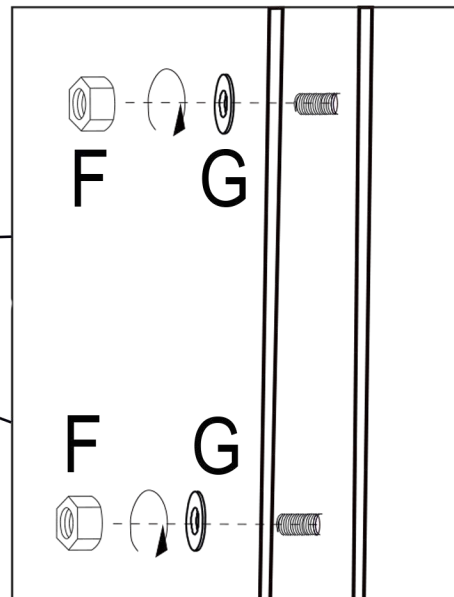
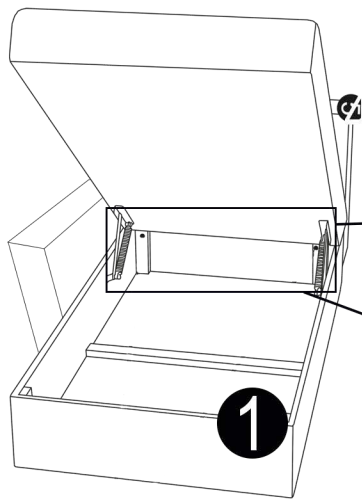
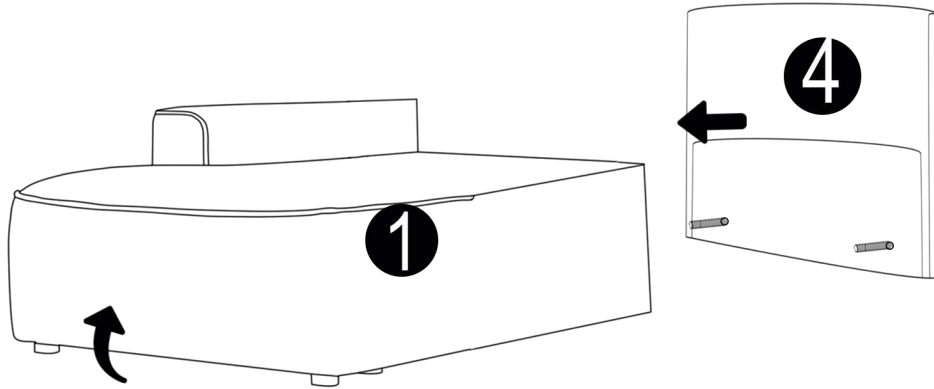
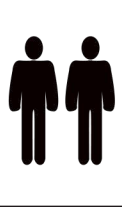

<b>G</b> Ø 8mm  x2	<b>F</b> Ø 8mm  x2
-----------------------------	-----------------------------

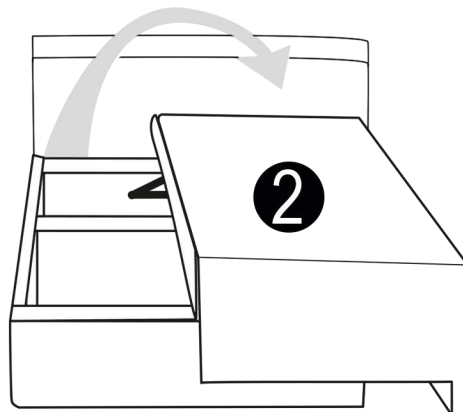

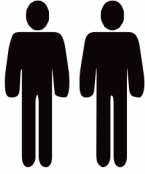

**D**  
Ø3,5x35  
**x6**

