

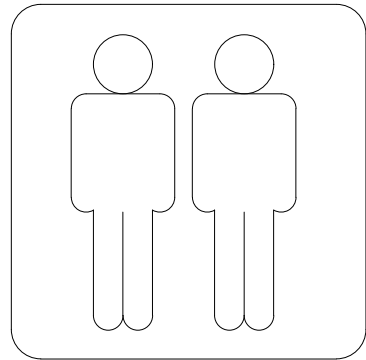

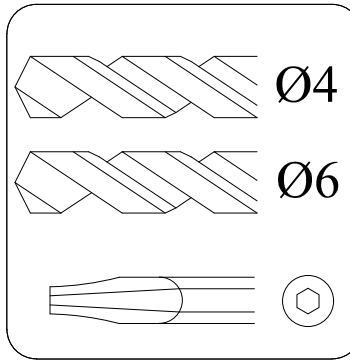

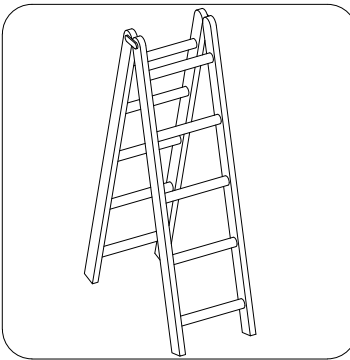

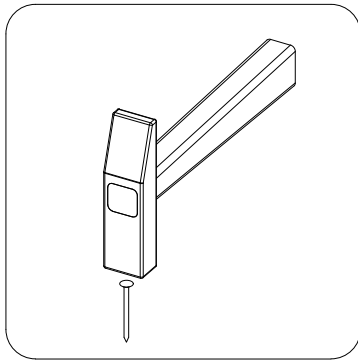

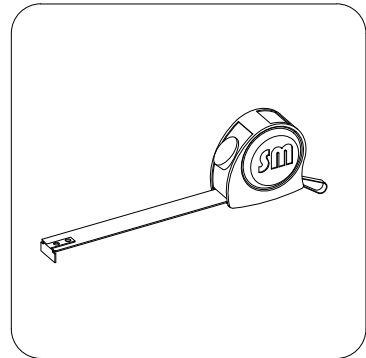
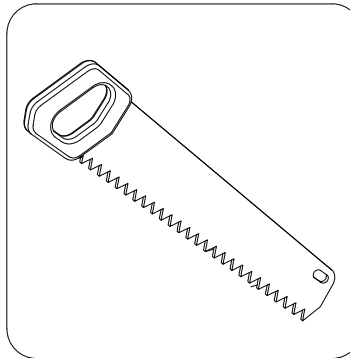
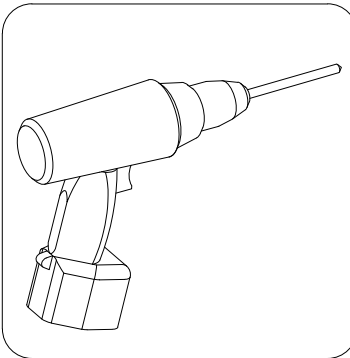
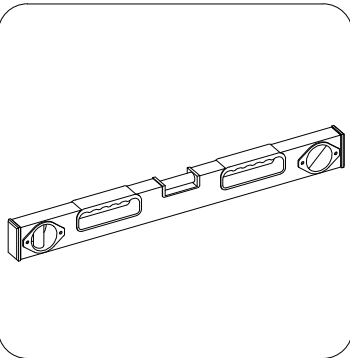
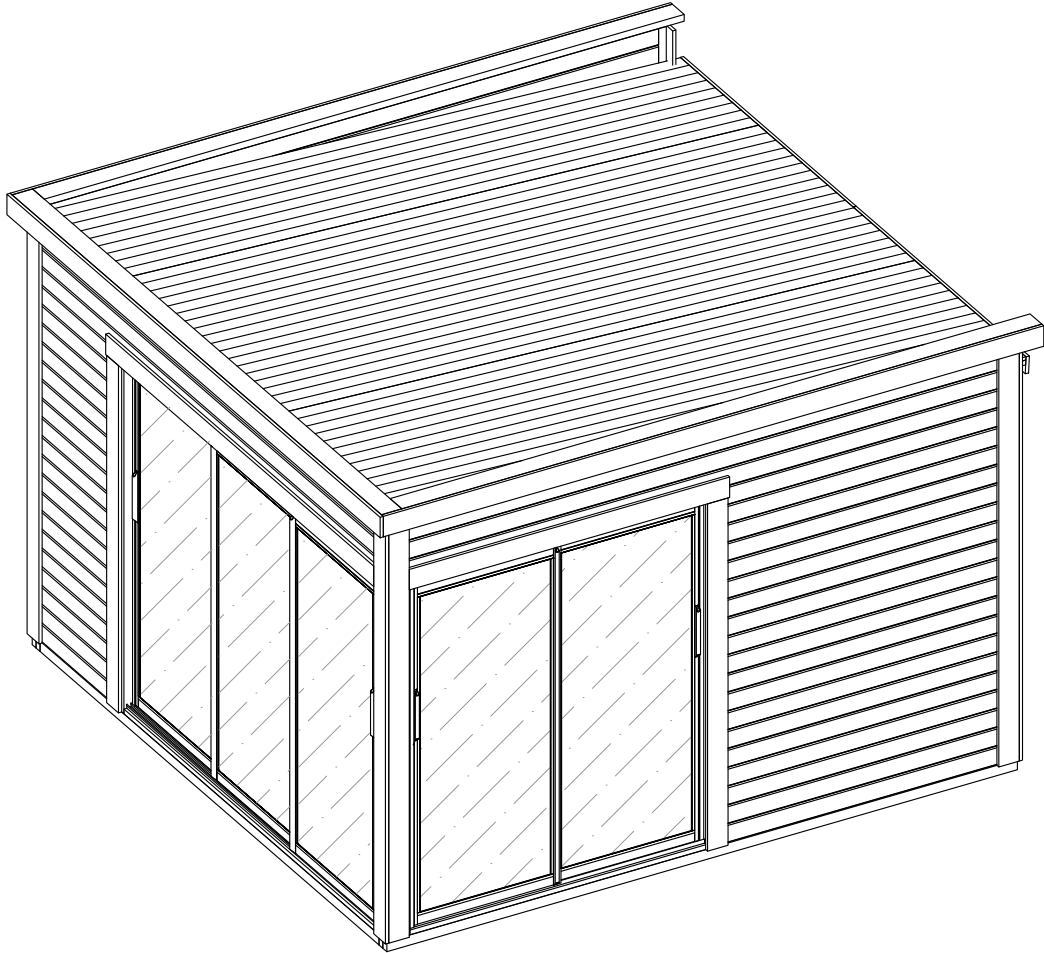
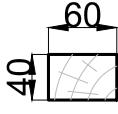

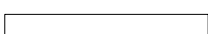

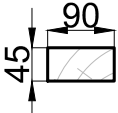
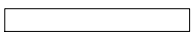

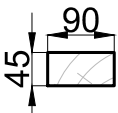

MONTAGEANLEITUNG

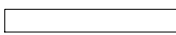
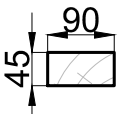
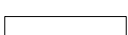

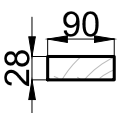

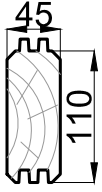
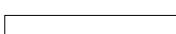

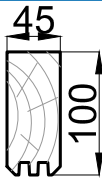
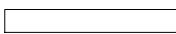



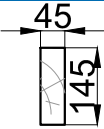
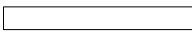
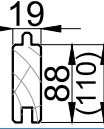

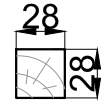

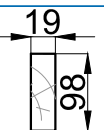
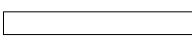
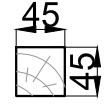

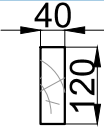
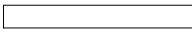
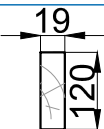
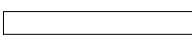
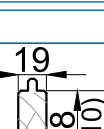

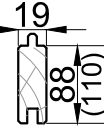
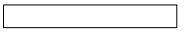
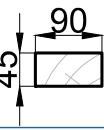

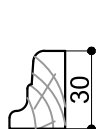

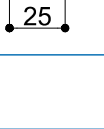

## SPEZIFIKATION











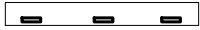

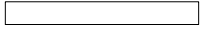

FUNDAMENTBALKEN						
		①	3440	10	FUNDAMENTBALKEN	
		②	3695	4	FUNDAMENTBALKEN	
		③	400	9	FUNDAMENTBALKEN	
RAHMENBRETT						
		④	2300	2	RAHMENBRETT	
		⑤	2180	2	RAHMENBRETT	
		⑥	2090	4	RAHMENBRETT	
		⑦	2470	2	RAHMENBRETT	
		⑧	1781	1	RAHMENBRETT	
		⑨	1736	1	RAHMENBRETT	
		⑩	3420	1	RAHMENBRETT	
		⑪	2623	1	RAHMENBRETT	
		⑫	2578	1	RAHMENBRETT	
		⑬	1736	1	RAHMENBRETT	
		⑭	2578	1	RAHMENBRETT	
WANDBRETT						
		⑮	3600	48+1	BRETT FÜR VORDER-/RÜCKSEITE	
		⑯	1729	19	BRETT FÜR SEITENWAND	
		⑰	887	19	BRETT FÜR SEITENWAND	
		⑱	3600	4	BRETT FÜR VORDER-/RÜCKSEITE	



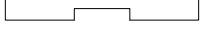

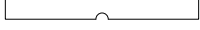
PRECÍZÁ GARINÁŠANA

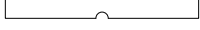
## SPEZIFIKATION

DACHBRETT						
		19	3510	5	DACHSPARREN	
		20	3730	40+1 (32+1)	DACHBRETT	
		21	1755	2	WINDBRETT LEISTE	
		22	1755	2	WINDBRETT	
		23	220	2	DACHBRETT LEISTE	
		24	3750	3	WINDBRETT	
		25	3788	1	WINDBRETT	
		26	3870	2	WINDBRETT	
BODENBRETT						
		27	3555	40+1 (32+1)	BODENBRETT	
		28	707	1	BODENBRETT	
		29	3420	2	BODENLEISTE	
		30	1554	1	BODENLEISTE	
		31	840	1	BODENLEISTE	
		32	2300	2	RAHMENBLLENDE	
		33	2520	6	RAHMENBLLENDE	
		34	2035	2	RAHMENBLLENDE	
		35	1880	1	RAHMENBLLENDE	
		36	2720	1	RAHMENBLLENDE	

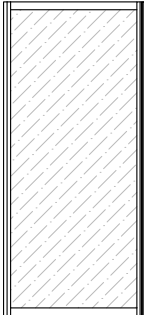
## SPEZIFIKATION

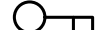
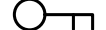
SCHIEBETÜR-SYSTEM						
		A1	2578	1	UNTERE SCHIENE	
		A2	2578	1	OBERE SCHIENE	
		B1	1736	1	UNTERE SCHIENE	
		B2	1736	1	OBERE SCHIENE	
		C1	2000	1	SEITENPROFIL	
		C2	2000	1	SEITENPROFIL	
		C3	2000	1	SEITENPROFIL	
		C4	2000	1	SEITENPROFIL	

GLASSCHIEBETÜR					
	D1	.	1	GLASSCHIEBETÜR	
	D2	.	1	GLASSCHIEBETÜR	
	D3	.	1	GLASSCHIEBETÜR	
	D4	.	1	GLASSCHIEBETÜR	
	D5	.	1	GLASSCHIEBETÜR	

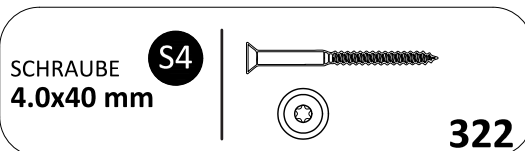
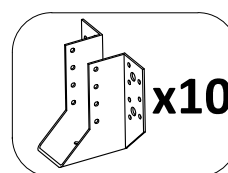
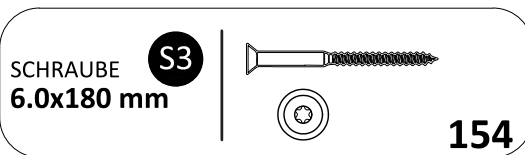
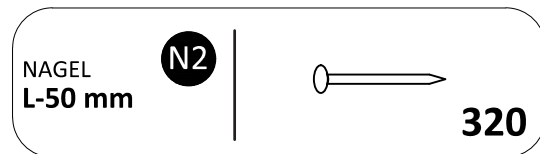
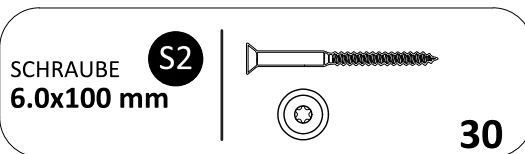
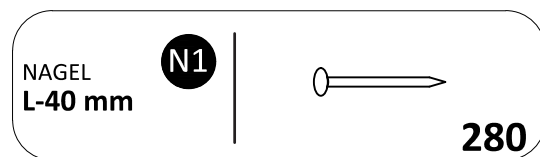
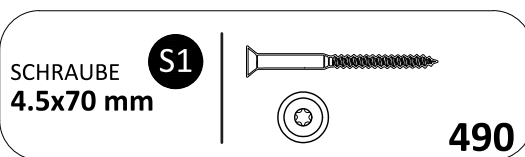

WÄNDE

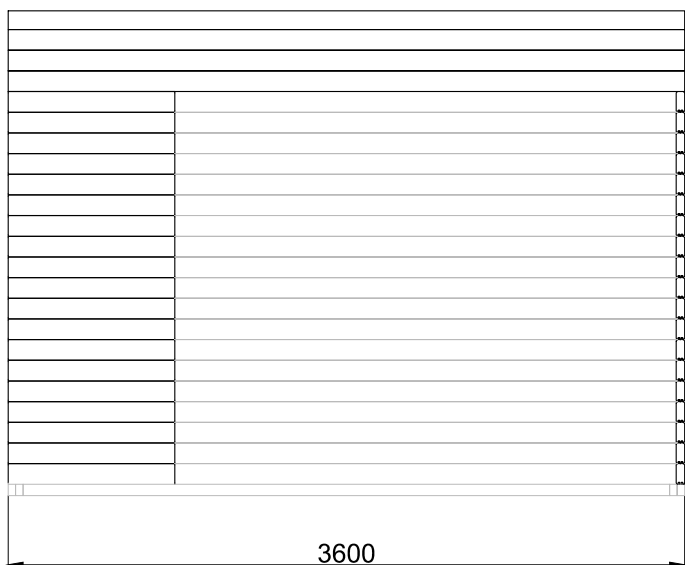

23  
22  
21  
20  
19  
18  
17  
16  
15  
14  
13  
12  
11  
10  
9  
8  
7  
6  
5  
4  
3  
2  
1

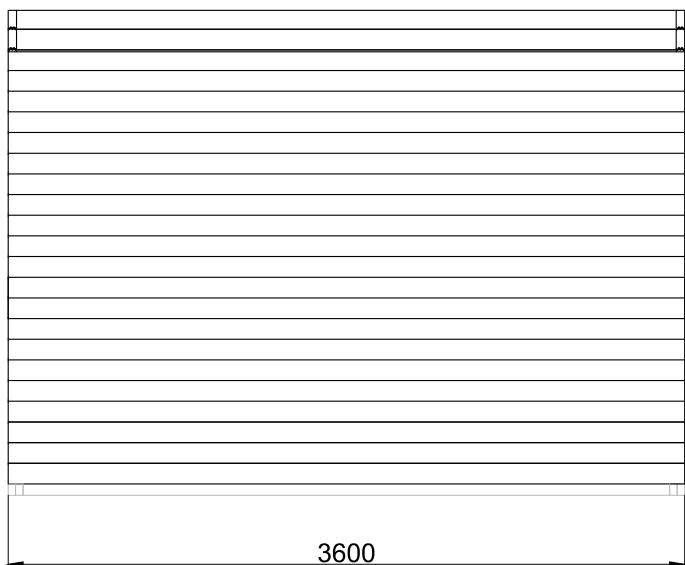
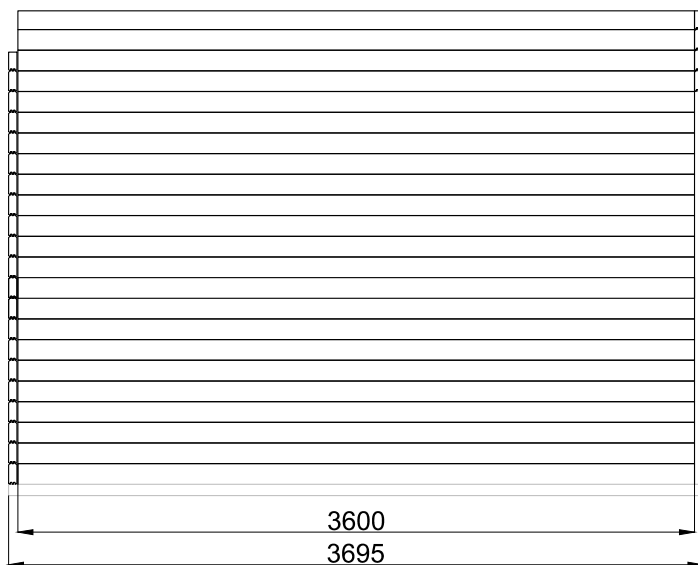

23  
22  
21  
20  
19  
18  
17  
16  
15  
14  
13  
12  
11  
10  
9  
8  
7  
6  
5  
4  
3  
2  
1

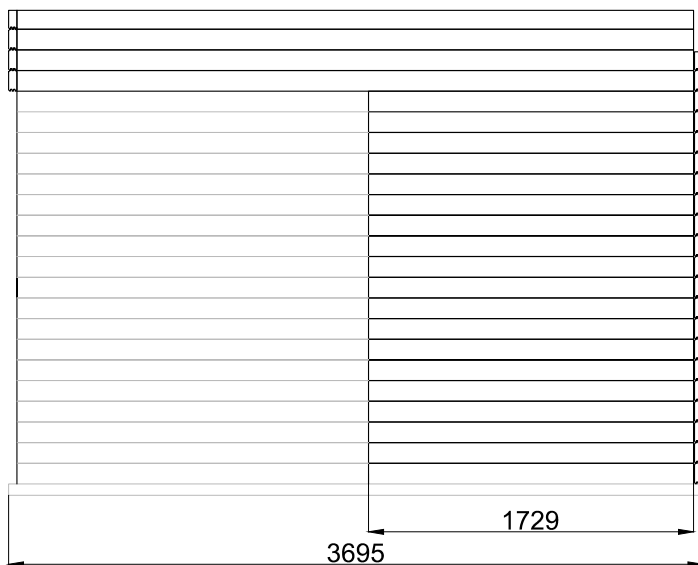

## FUNDAMENTTRAHMEN - ANLEITUNG

## FUNDAMENTTRAHMEN ZUBEHÖR

		①	3440	10	FUNDAMENTBALKEN
		②	3695	4	FUNDAMENTBALKEN
		③	400	9	FUNDAMENTBALKEN

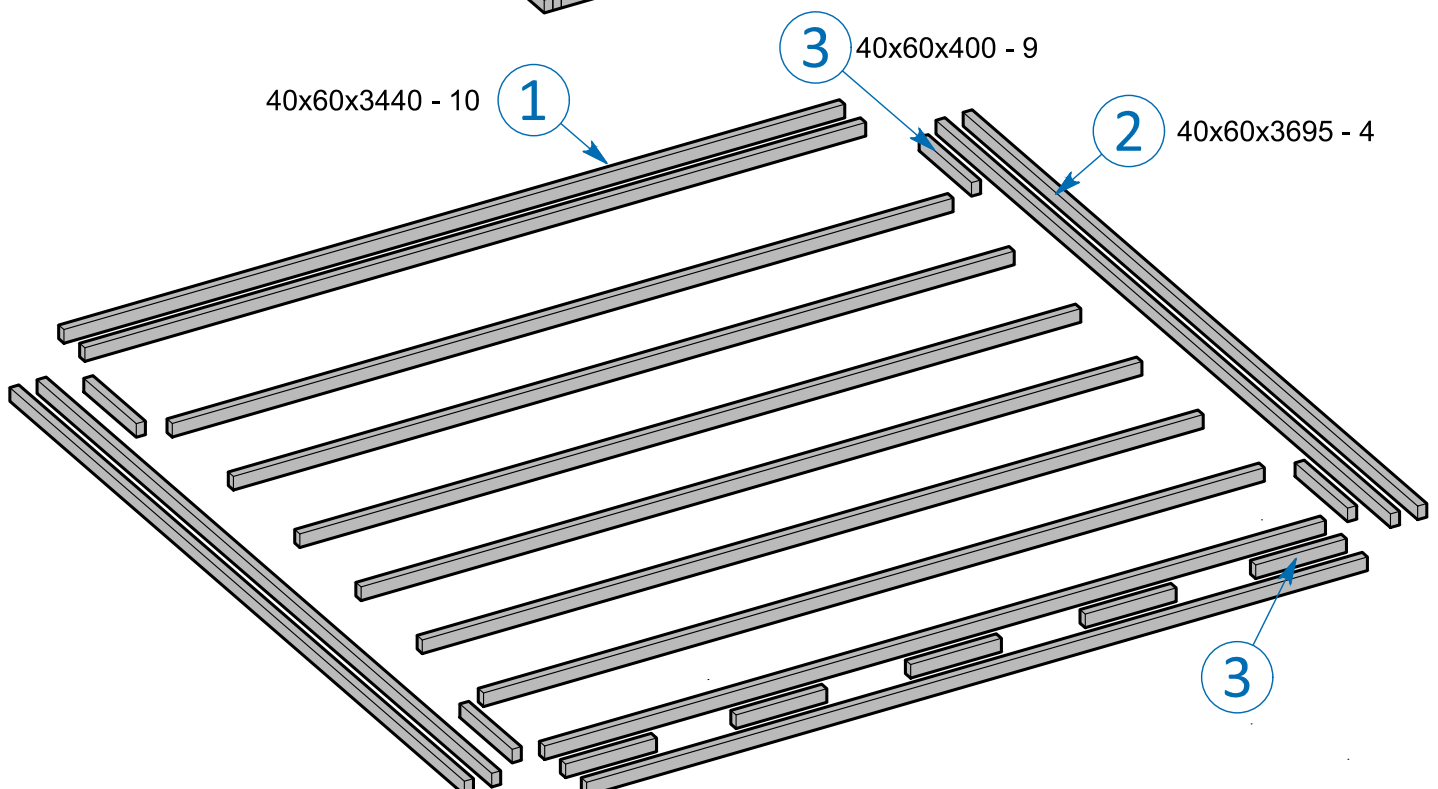
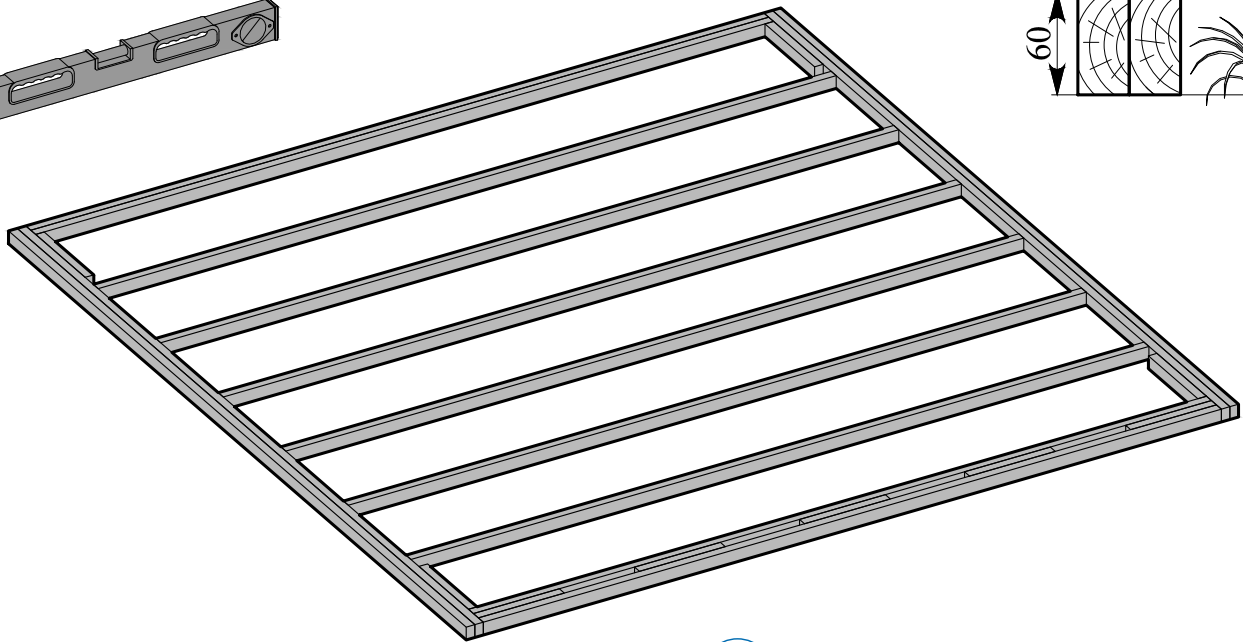
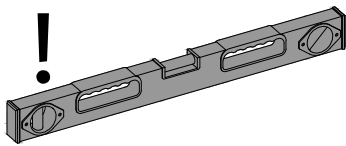

## FUNDAMENTRAHMEN MONTAGE

SCHRAUBE  
4.5x70 mm **S1**

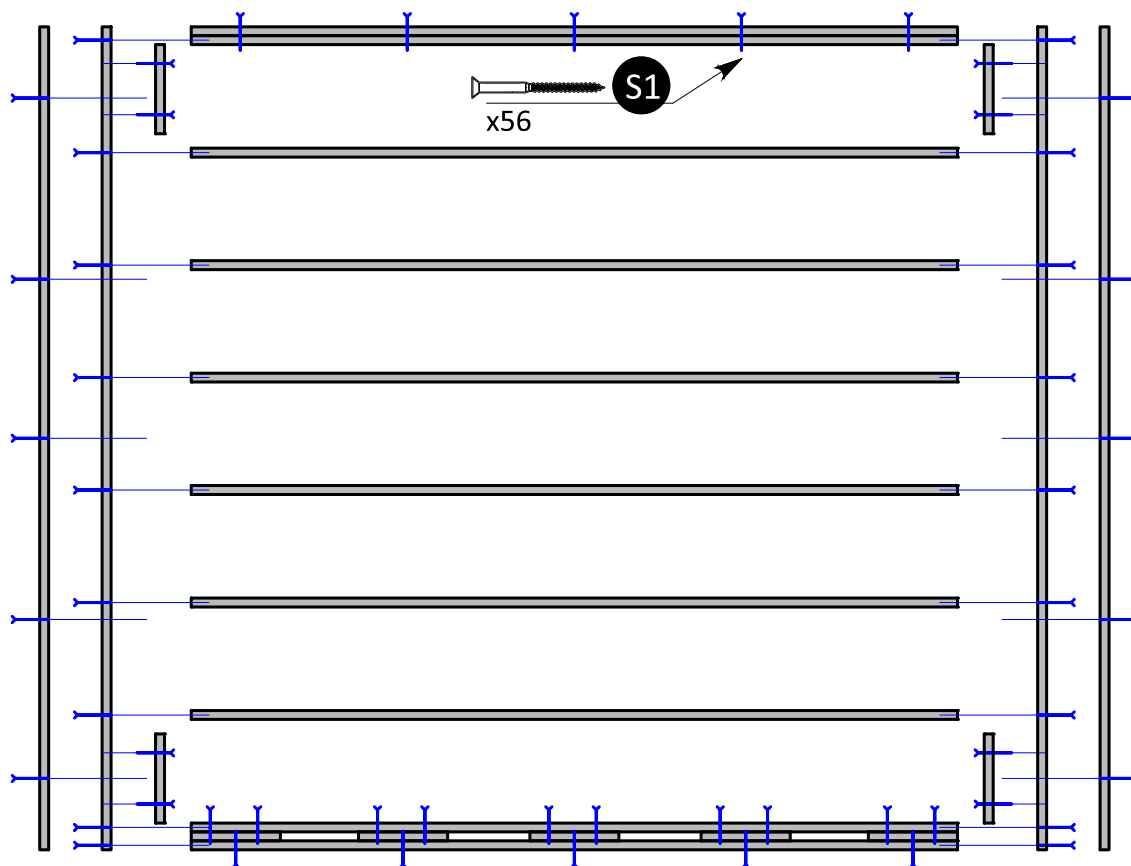
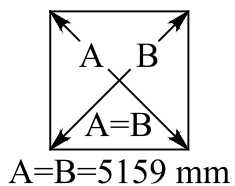
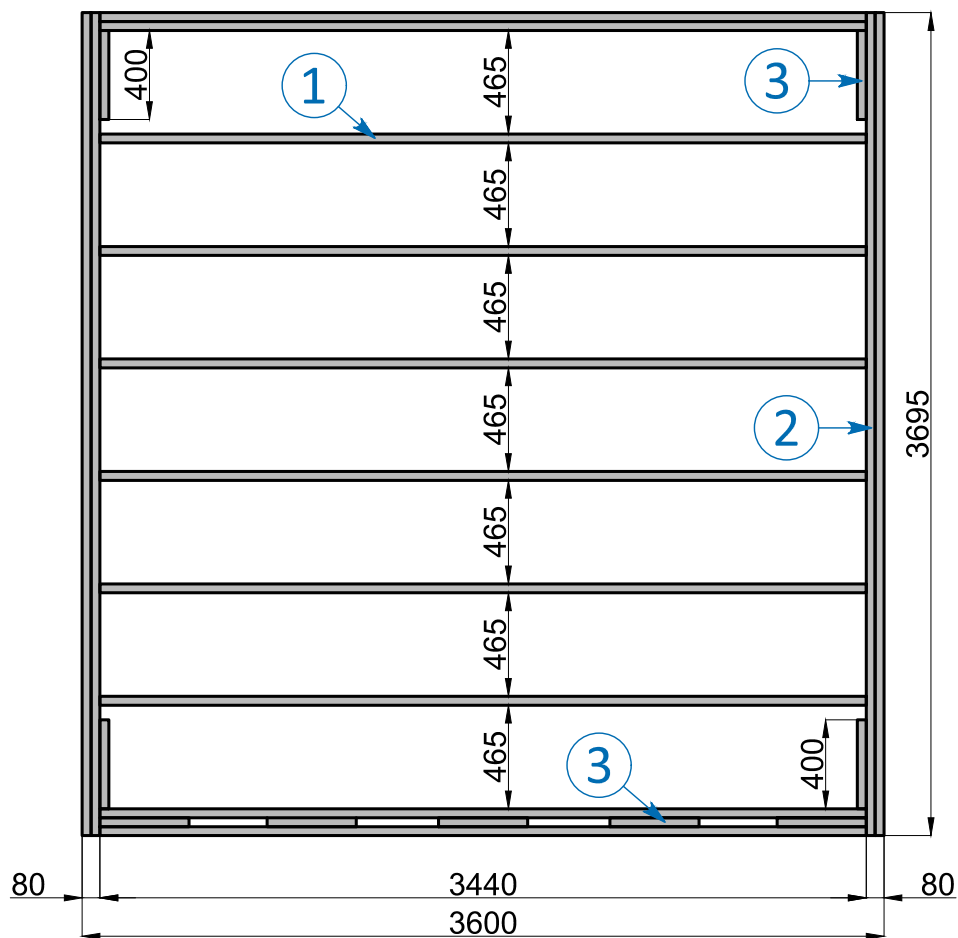





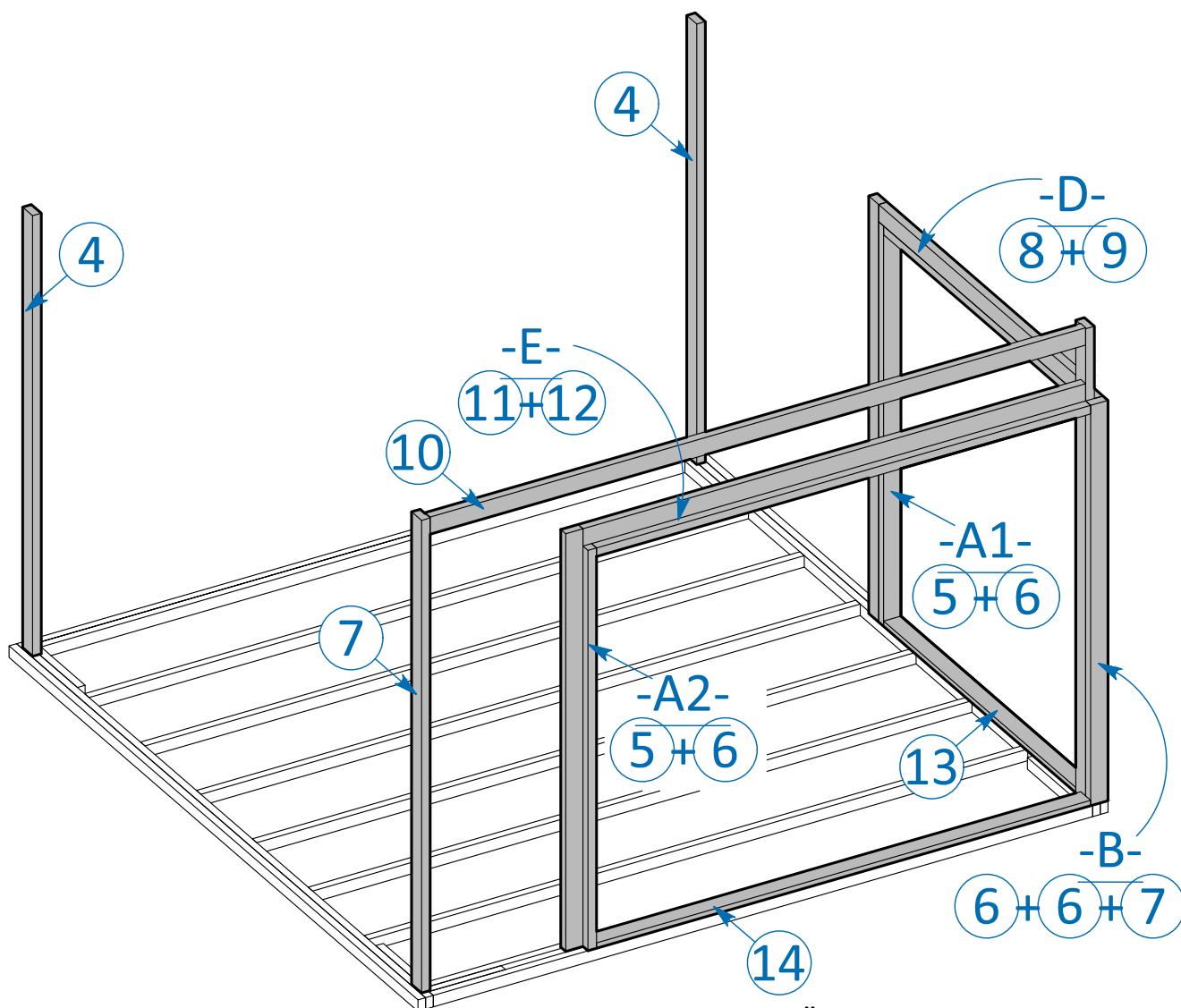

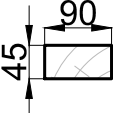

Vorbohren wird empfohlen.

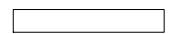
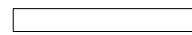
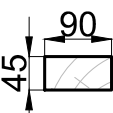
## RAHMEN - ANLEITUNG

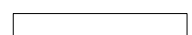
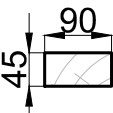

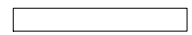
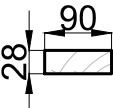
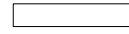
## RAHMEN ZUBEHÖR

		④	2300	2	RAHMENBRETT	
		⑤	2180	2	RAHMENBRETT	
		⑥	2090	4	RAHMENBRETT	
		⑦	2470	2	RAHMENBRETT	
		⑧	1781	1	RAHMENBRETT	
		⑨	1736	1	RAHMENBRETT	
		⑩	3420	1	RAHMENBRETT	
		⑪	2623	1	RAHMENBRETT	
		⑫	2578	1	RAHMENBRETT	
		⑬	1736	1	RAHMENBRETT	
		⑭	2578	1	RAHMENBRETT	





RAHMENBRETTER MONTAGE

-A1-  
5+6      -A2-  
5+6

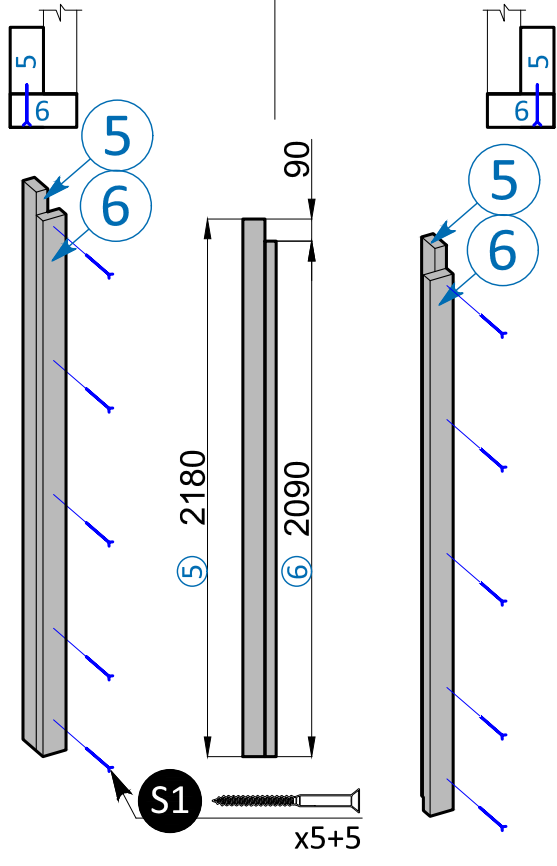

-B-  
6+6+7

SCHRAUBE  
4.5x70 mm S1

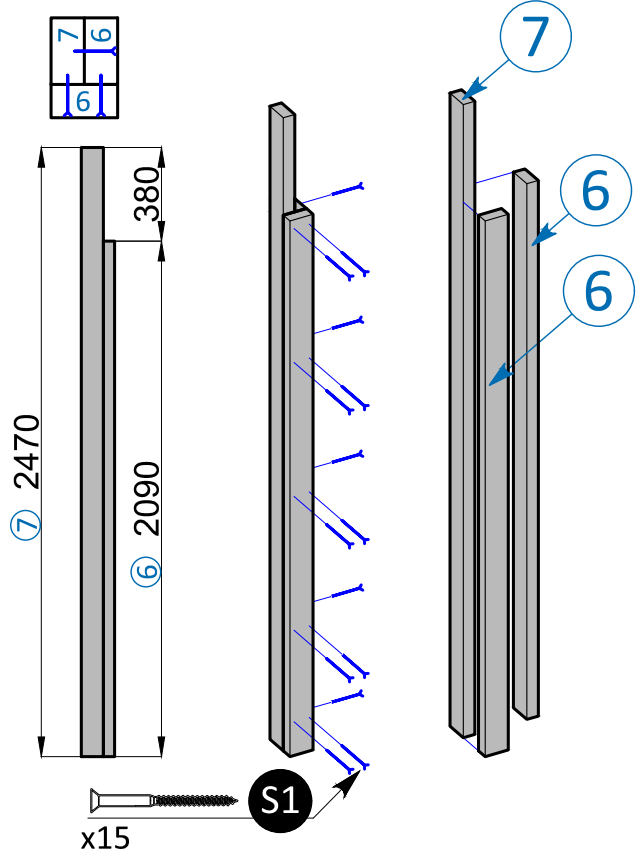

-E-  
11+12

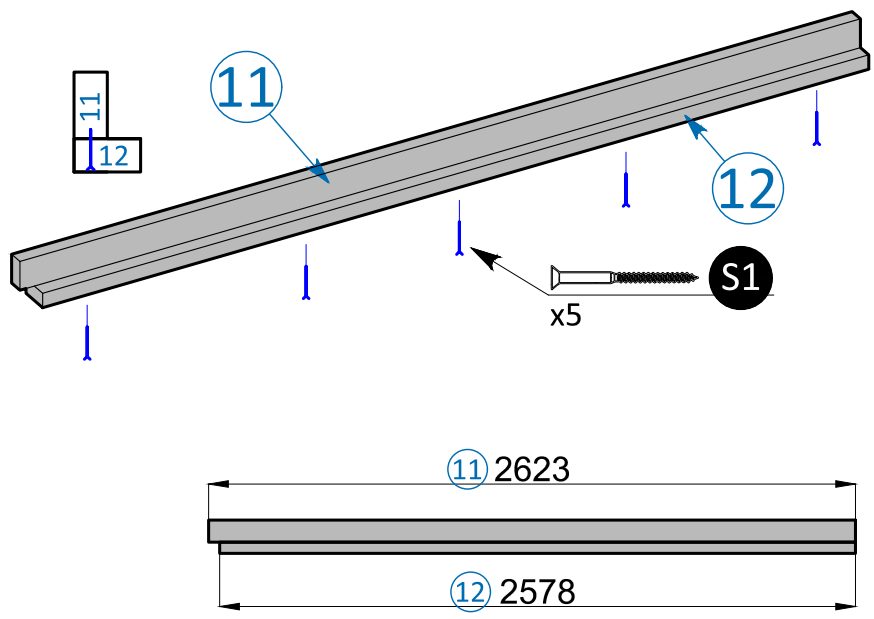

-D-  
8+9

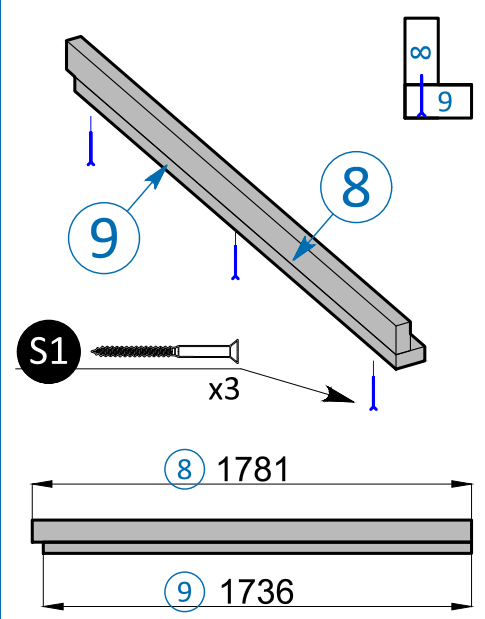

Vorbohren wird empfohlen.

## RAHMEN MONTAGE

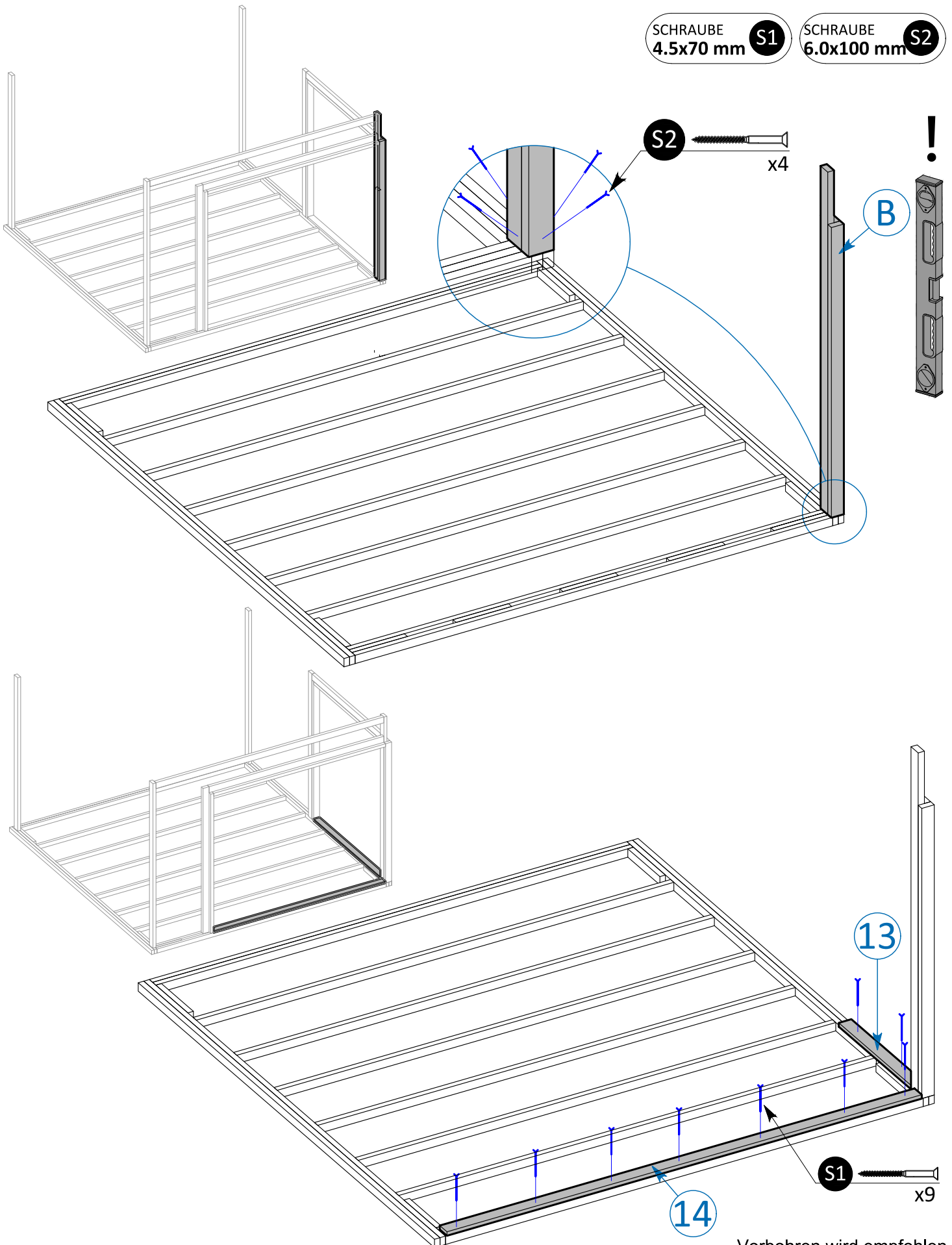

RAHMEN MONTAGE

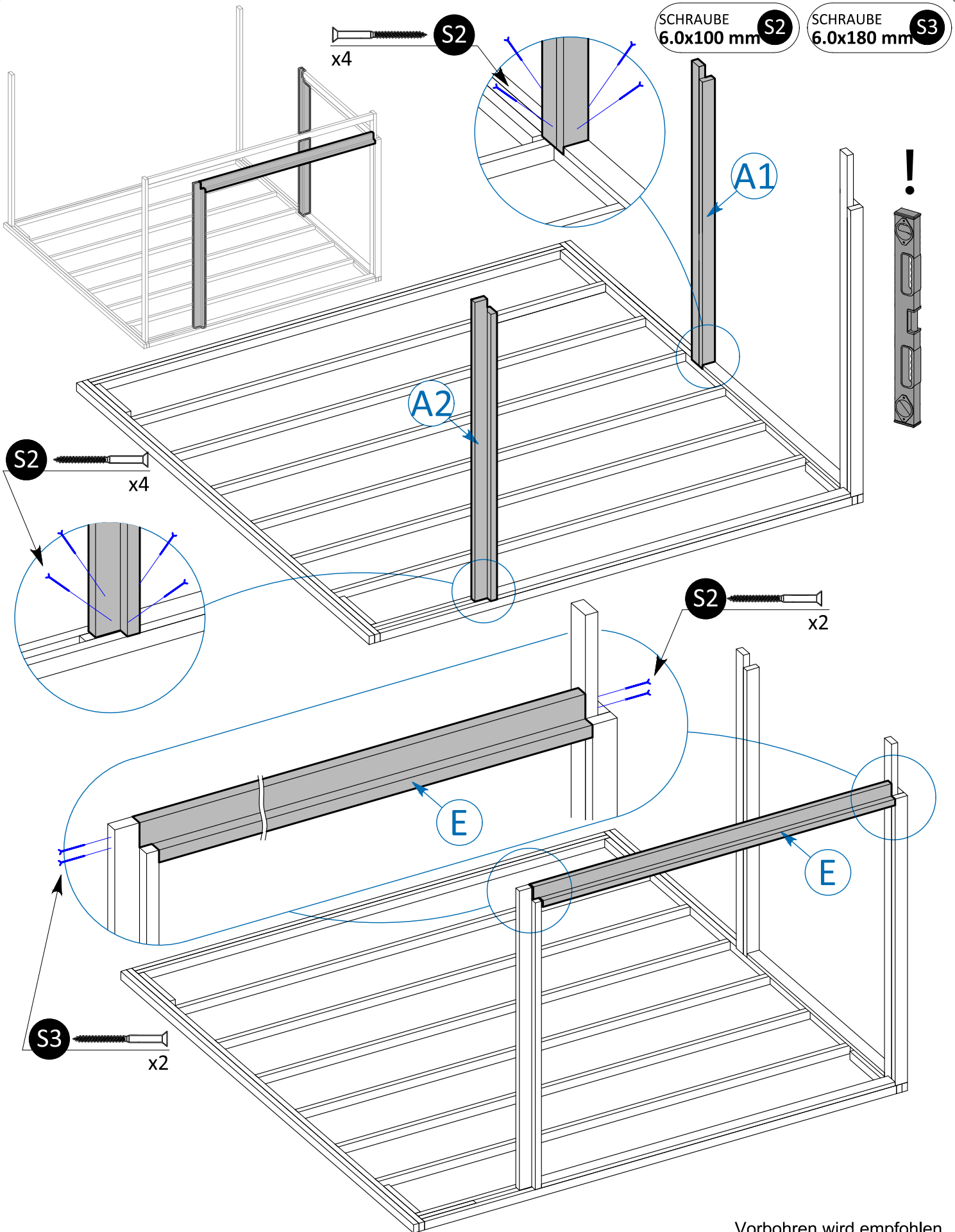

Vorbohren wird empfohlen.

RAHMEN MONTAGE

SCHRAUBE  
6.0x100 mm S2

SCHRAUBE  
6.0x180 mm S3

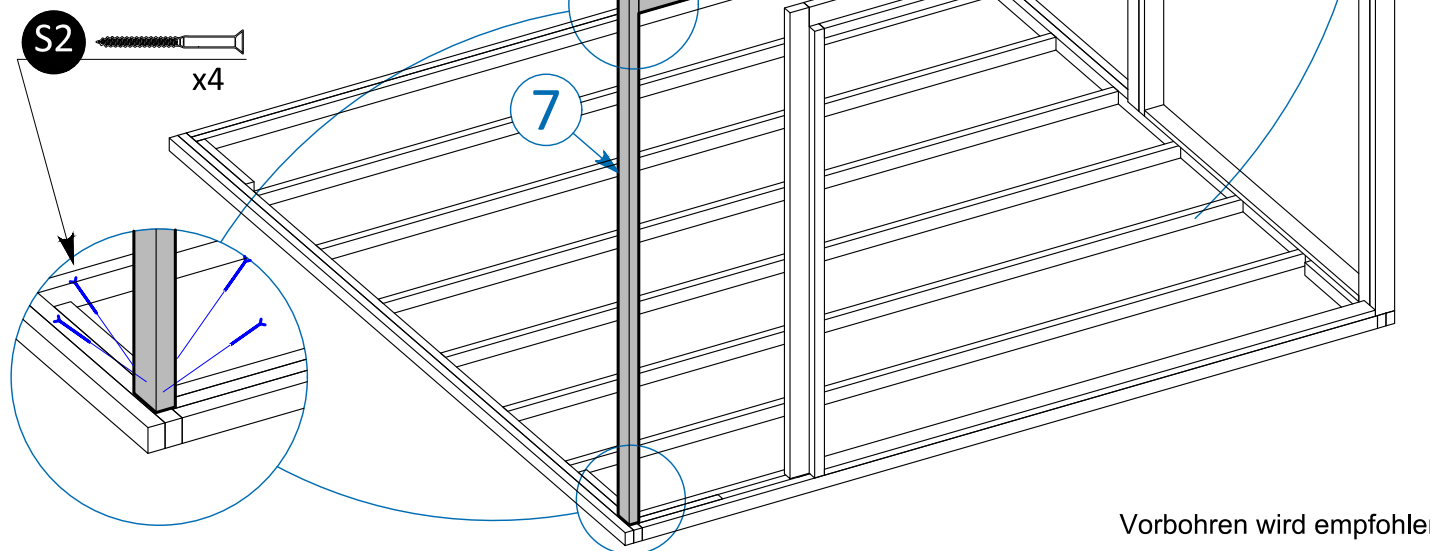
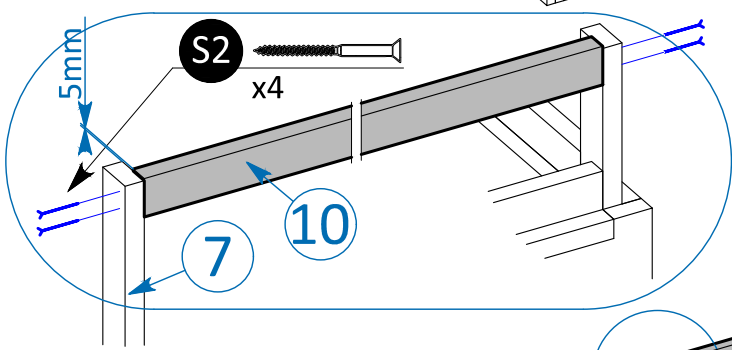
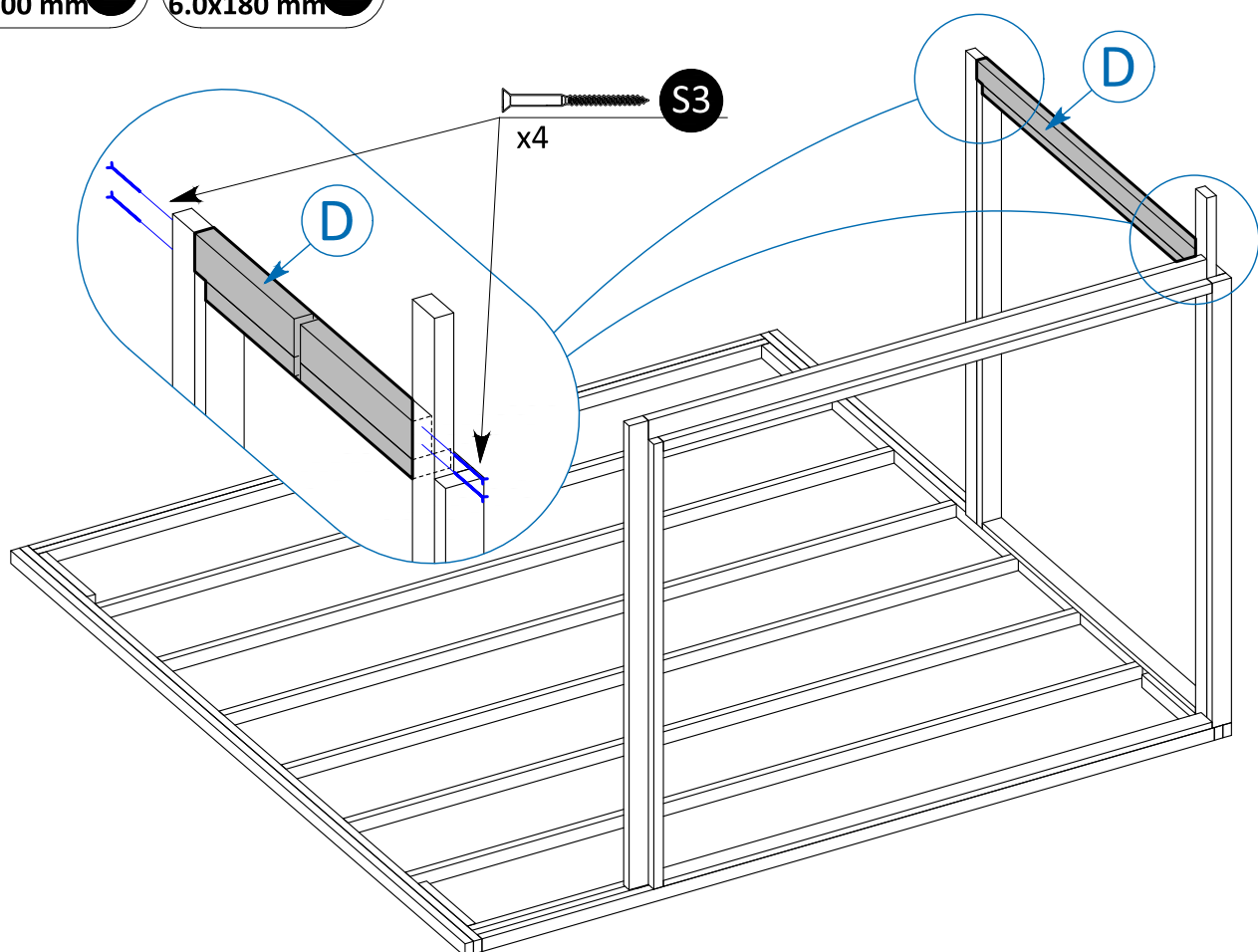

Vorbohren wird empfohlen.

RAHMEN MONTAGE

SCHRAUBE  
6.0x100 mm S2

S2 x4+4

4

4

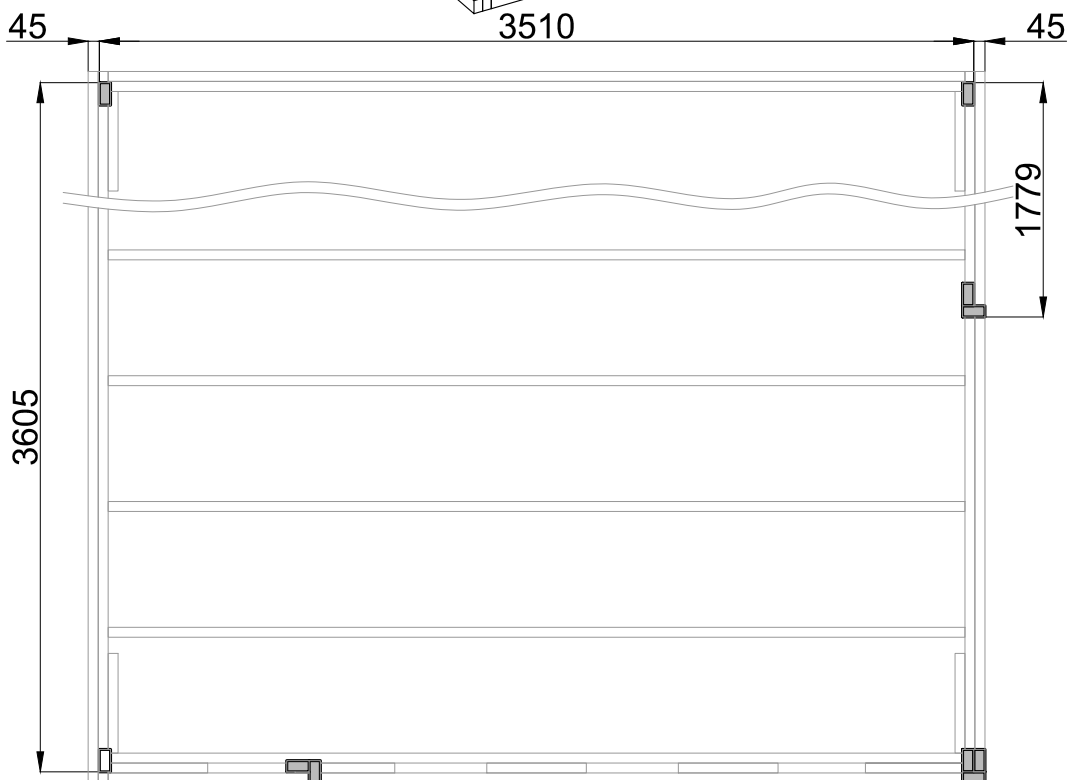
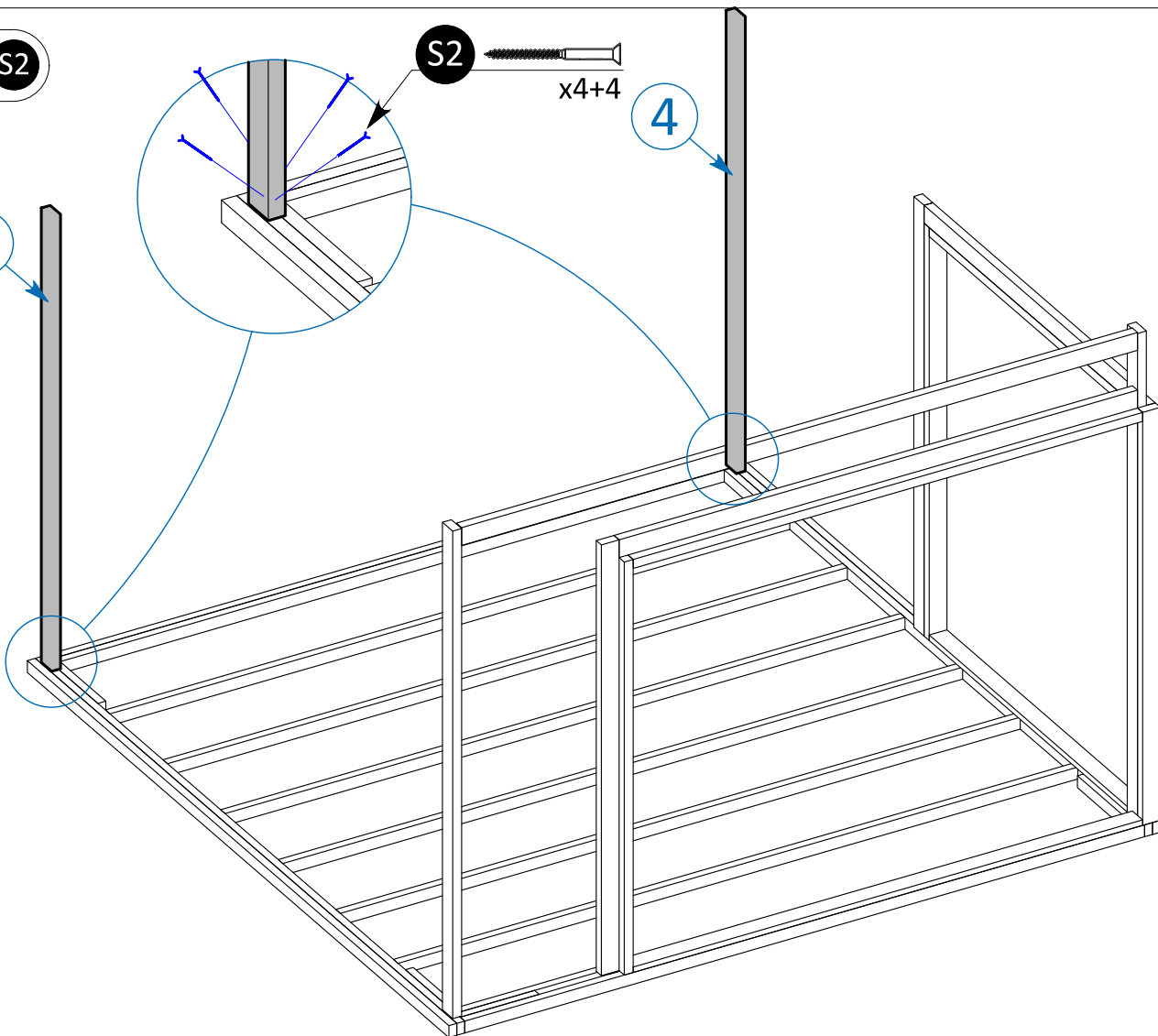
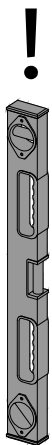

Vorbohren wird empfohlen.

## WAND MONTAGE

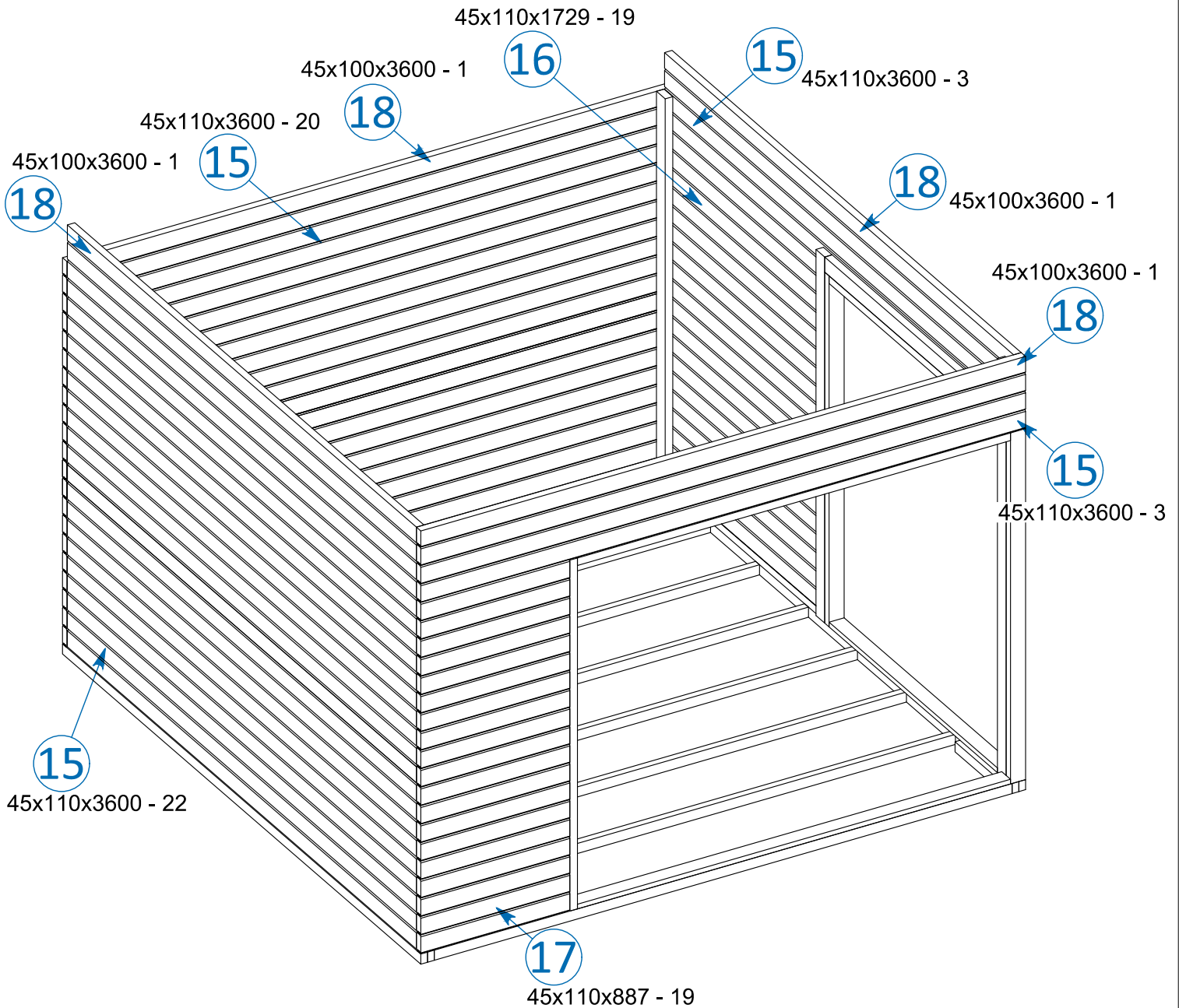

## WAND ZUBEHÖR

		15	3600	48	BRETT FÜR VORDER-/RÜCKSEITE	20+22 +3+3
		16	1729	19	BRETT FÜR SEITENWAND	
		17	887	19	BRETT FÜR SEITENWAND	
		18	3600	4	BRETT FÜR VORDER-/RÜCKSEITE	1+1 +1+1

## WAND MONTAGE

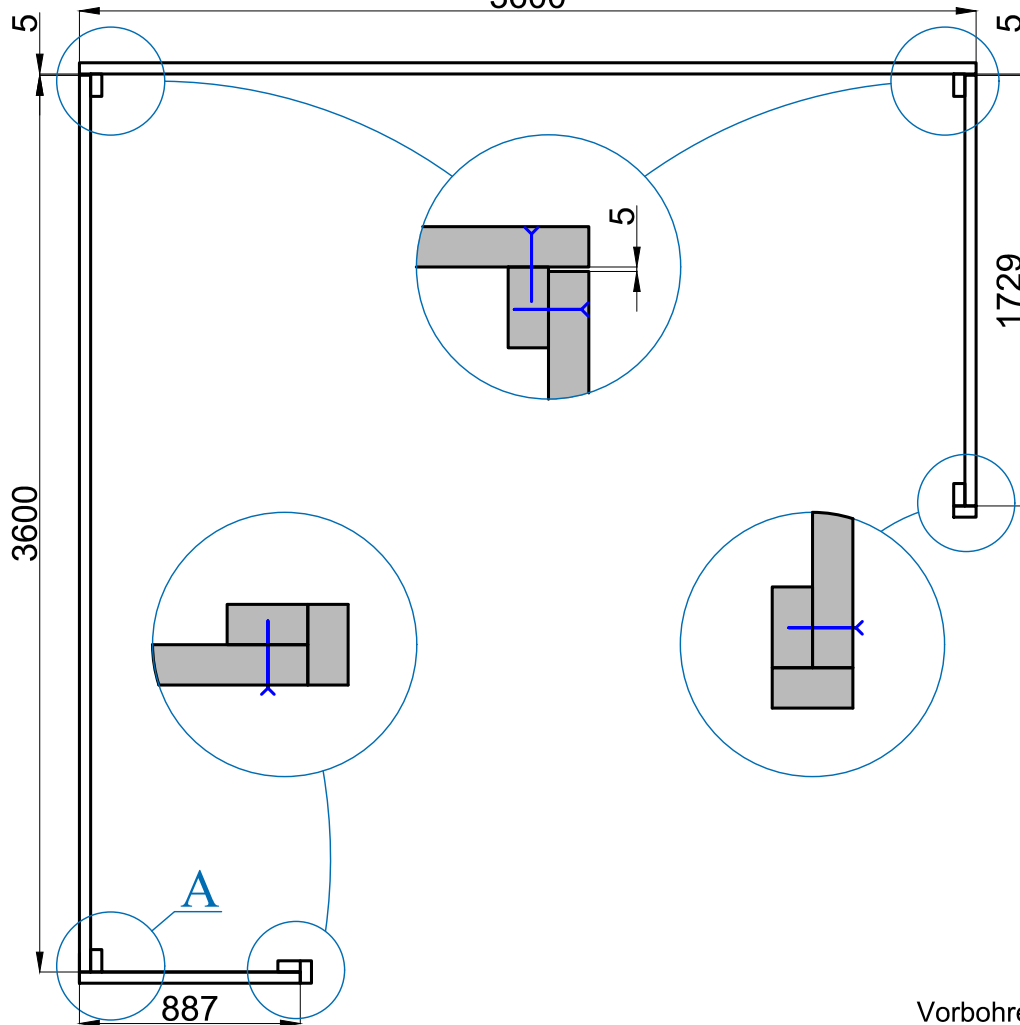
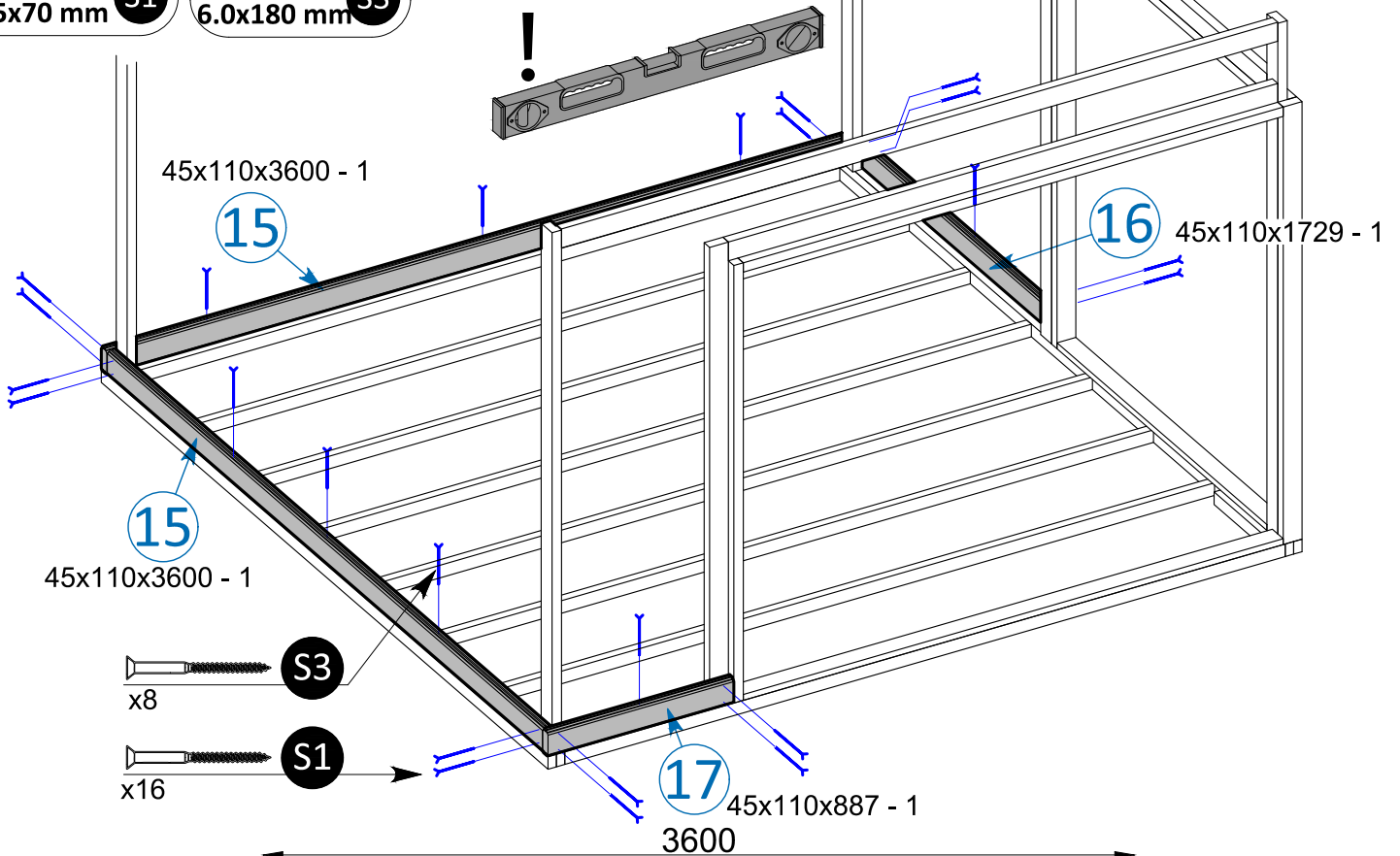
SCHRAUBE  
4.5x70 mm S1SCHRAUBE  
6.0x180 mm S3

Vorbohren wird empfohlen.



WAND MONTAGE

SCHRAUBE 4.5x70 mm S1

SCHRAUBE 6.0x180 mm S3

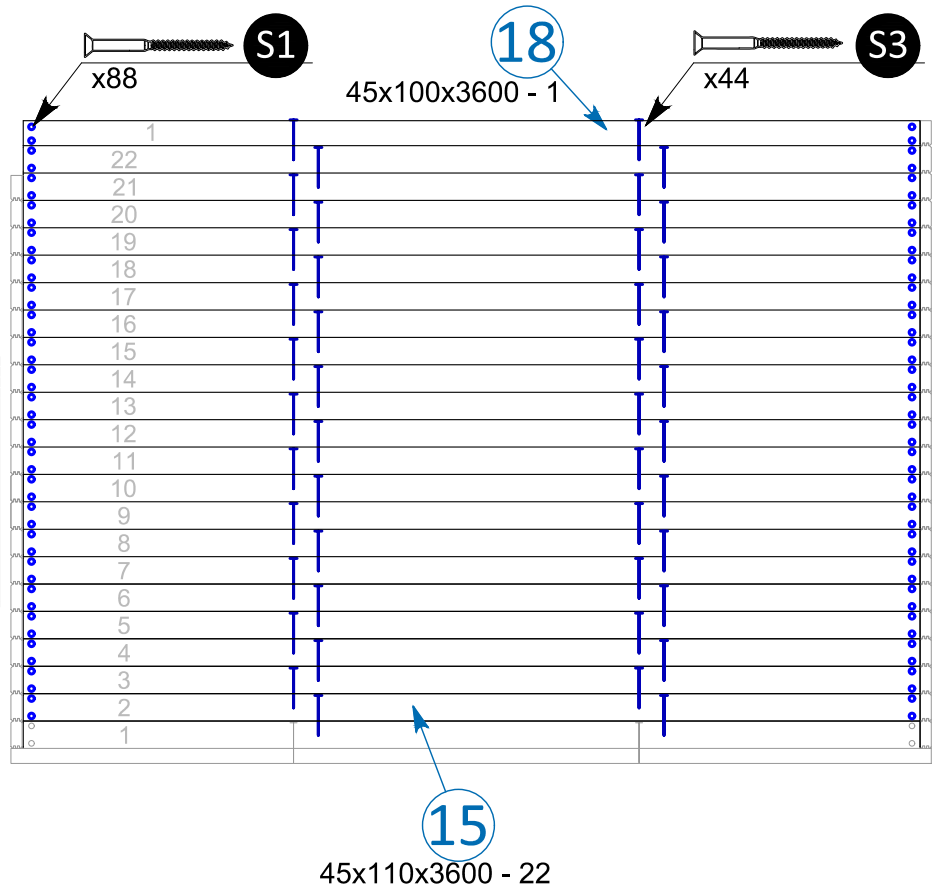
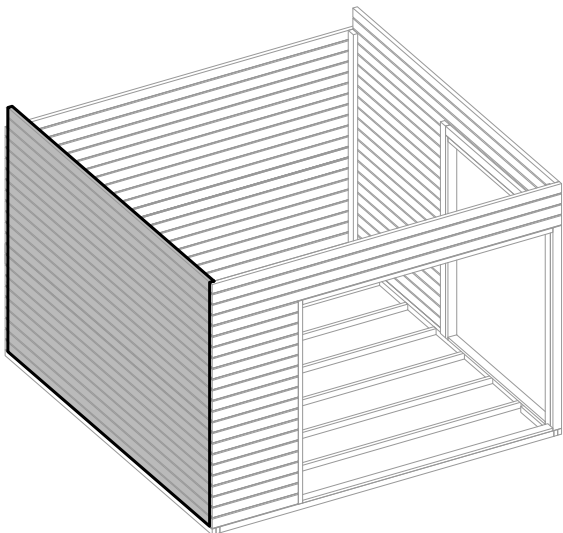
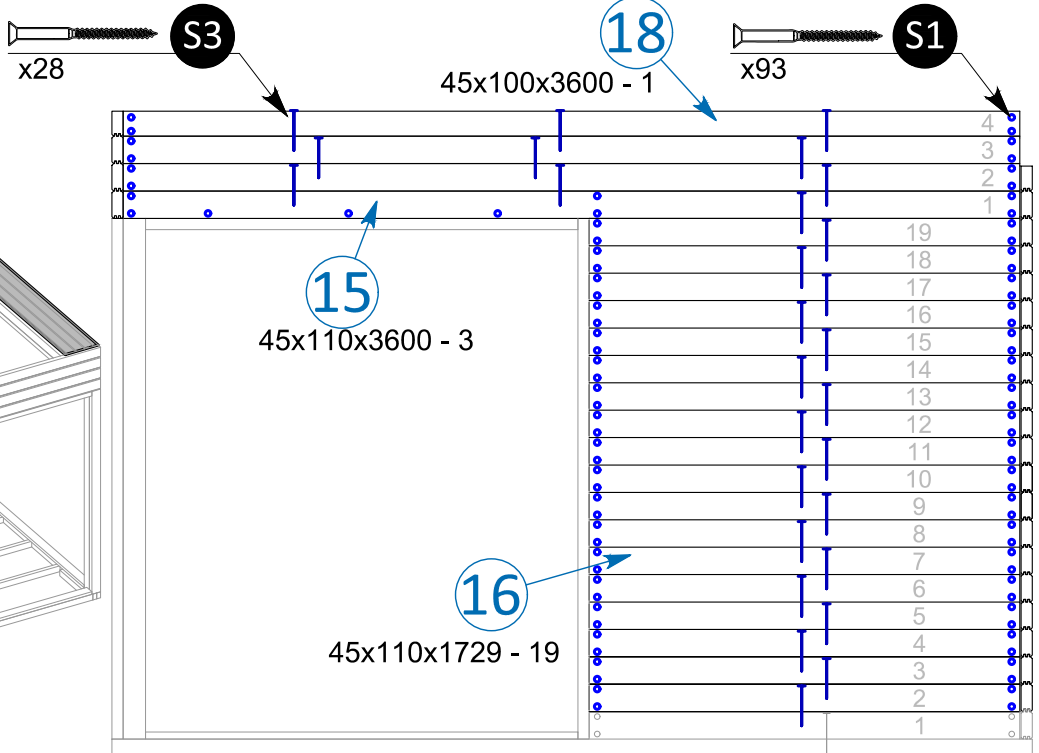
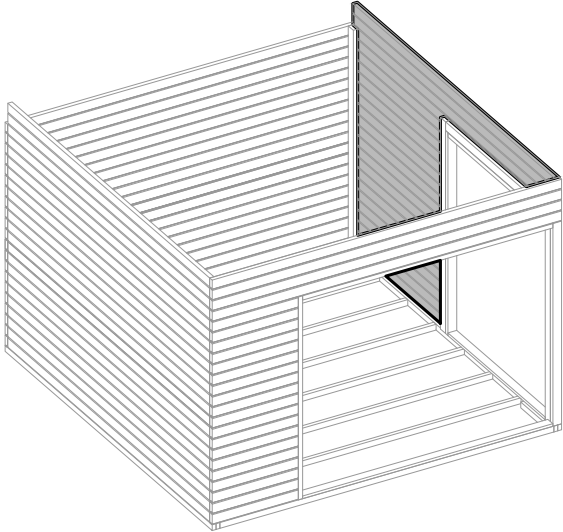
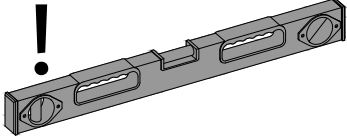

Vorbohren wird empfohlen.

WAND MONTAGE

SCHRAUBE 4.5x70 mm S1

SCHRAUBE 6.0x180 mm S3

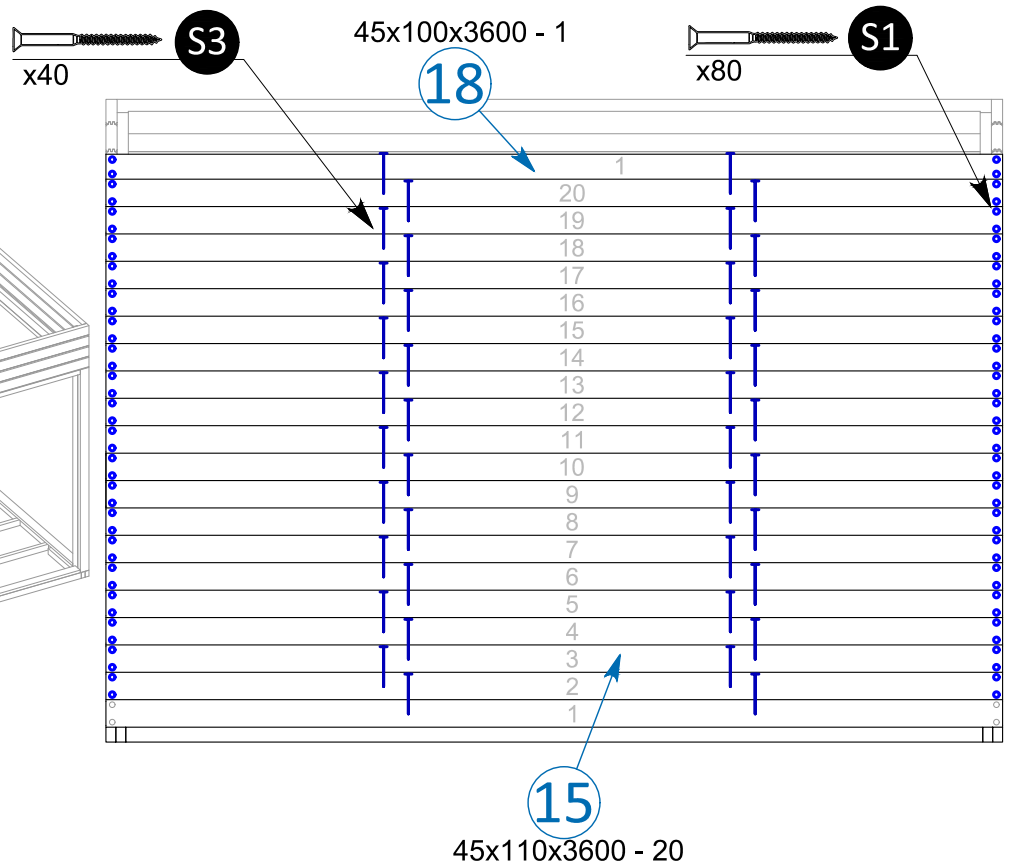
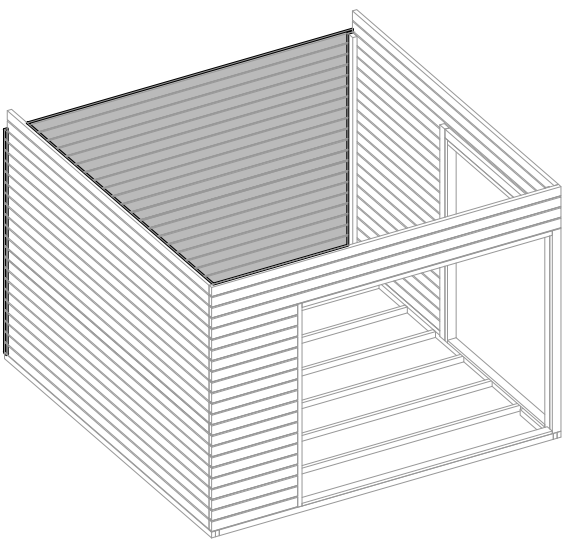
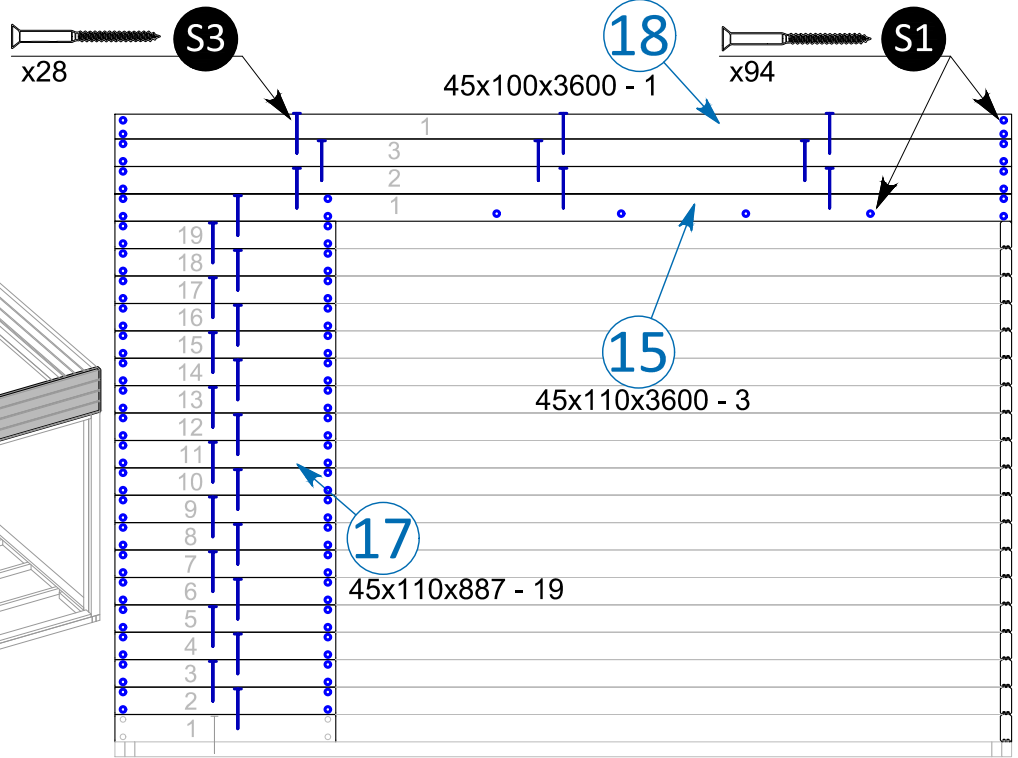
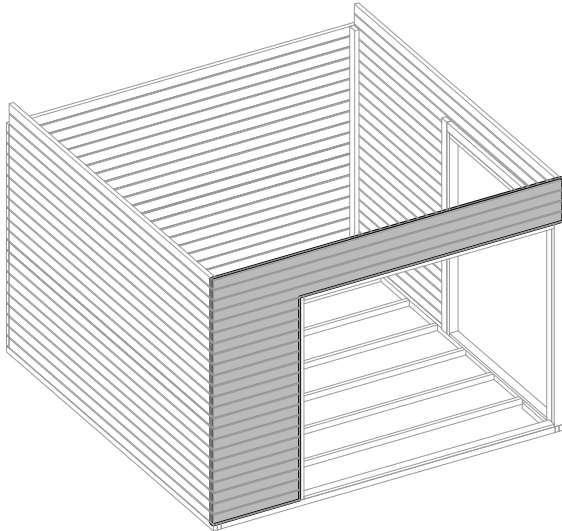
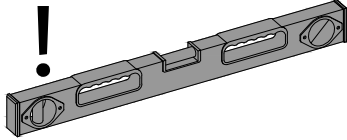

DACHSPARREN - MONTAGE

SCHRAUBE  
4.0x40 mm S4

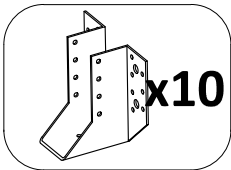

45x145x3510 - 5

19

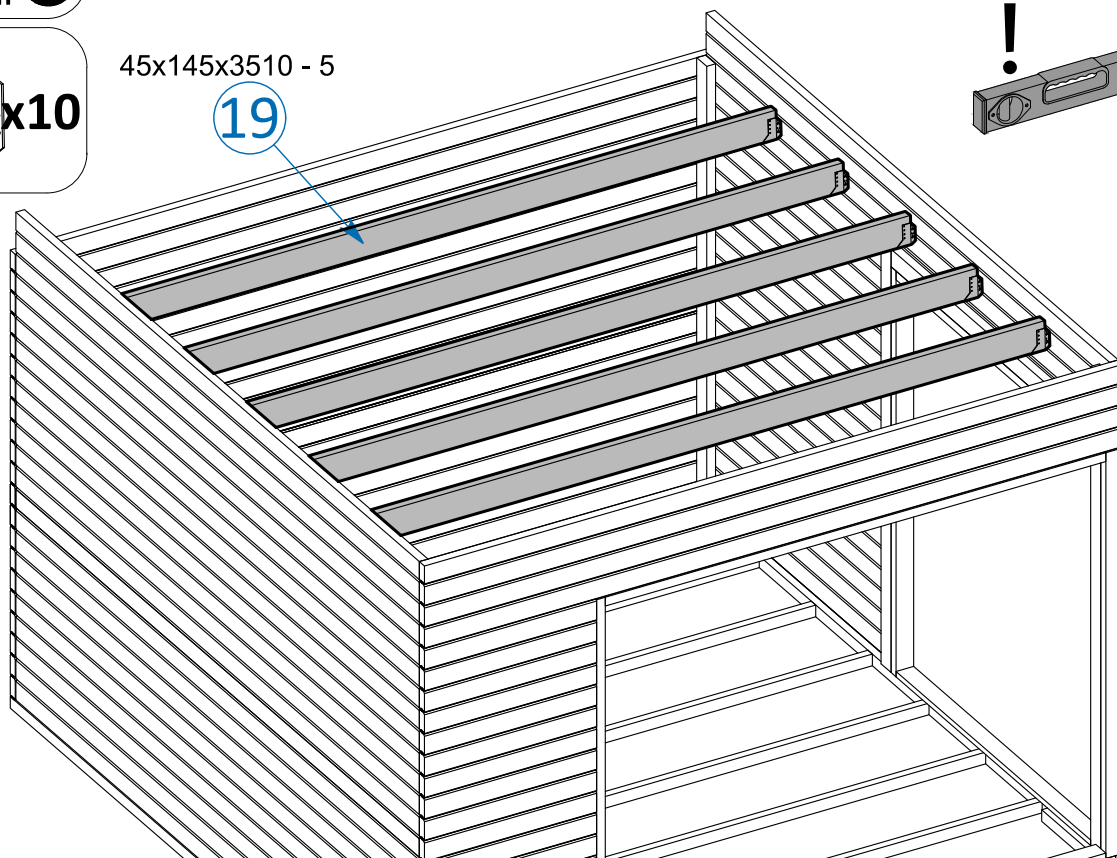
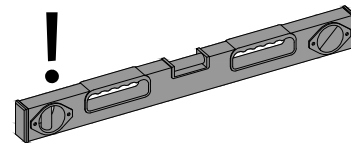

		3510	5	DACHSPARREN
--	--	------	---	-------------

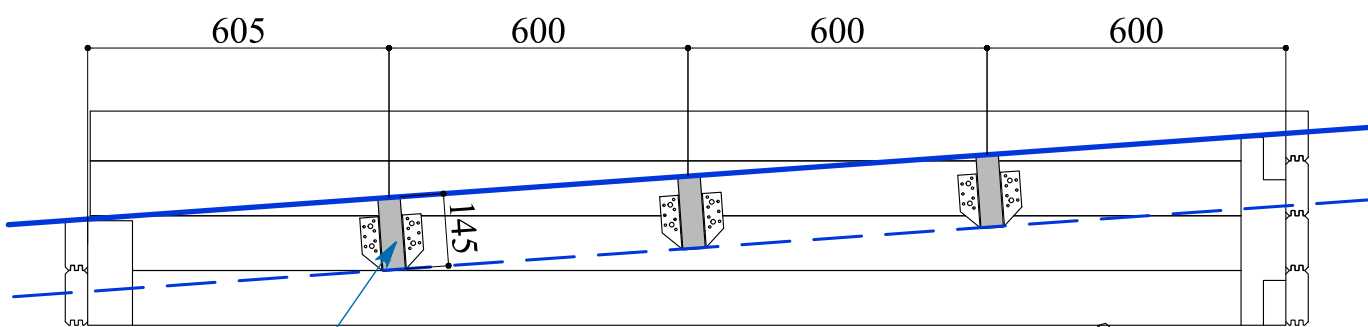

19

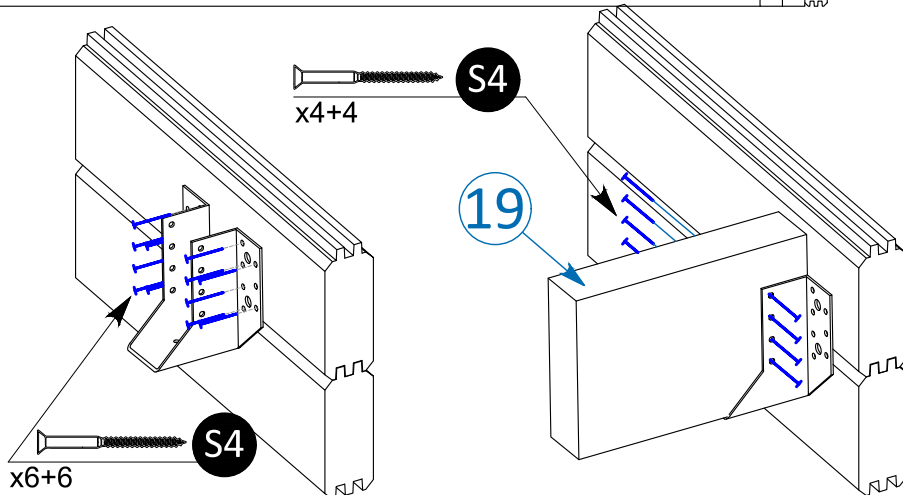

DACH - MONTAGE

NAGEL  
Lx40 mm

N1

SCHRAUBE  
4.5x70 mm

S1

SCHRAUBE  
4.0x40 mm

S4

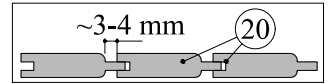

19x96x3730 - 40

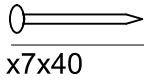

N1

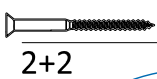

S1

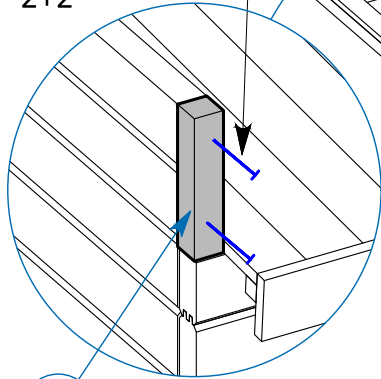

23

45x45x220 - 2

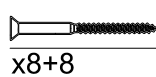

S4

21

22

21 22

28x28x1755 - 2  
19x98x1755 - 2

DACH ZUBEHÖR

		20	3730	40+1 (32+1)	DACHBRETT	
		21	1755	2	WINDBRETT LEISTE	
		22	1755	2	WINDBRETT	
		23	220	2	DACHBRETT LEISTE	

Vorbohren wird empfohlen.

WINDBRETT - MONTAGE

SCHRAUBE  
4.5x70 mm S1

40x120x3750 - 3

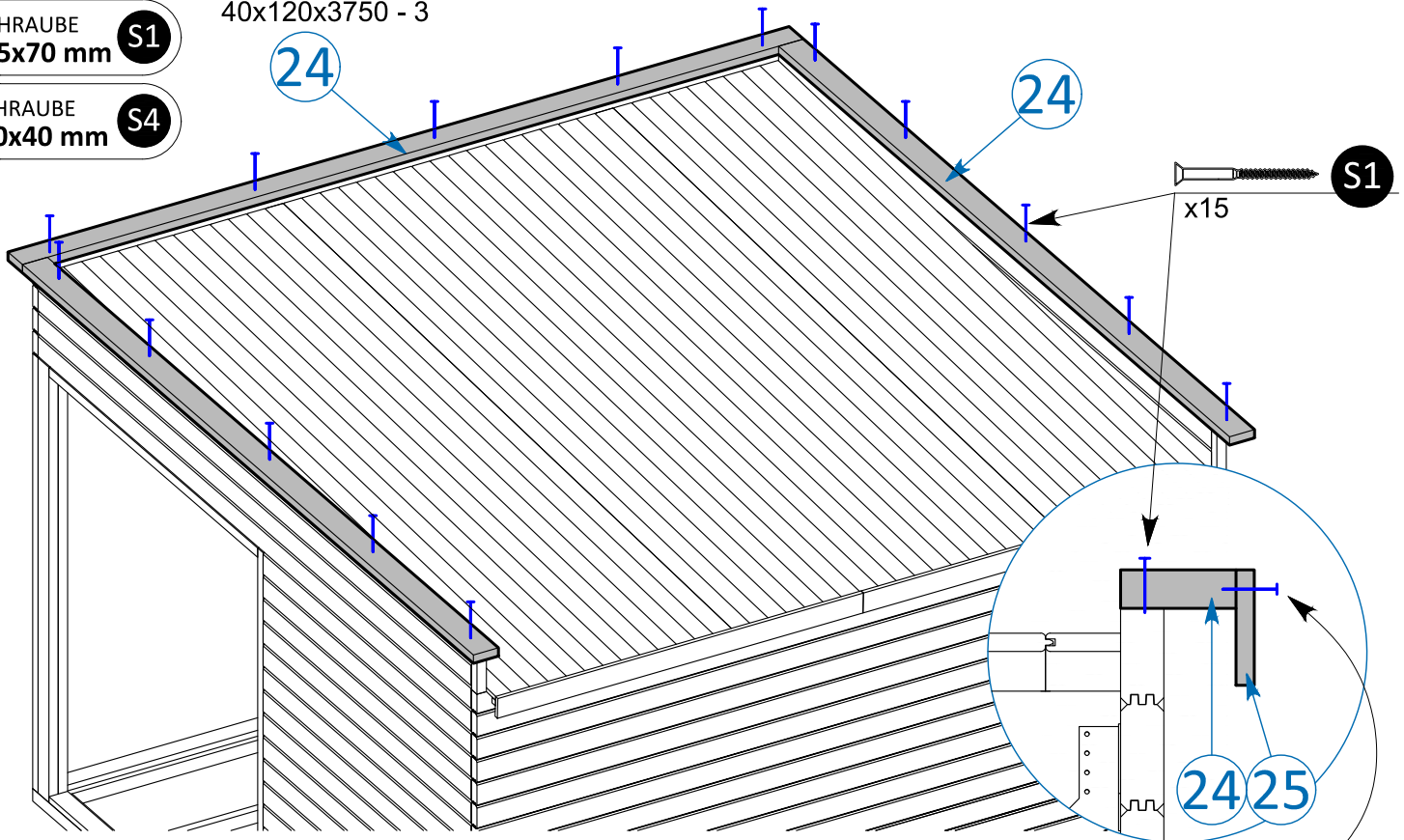

SCHRAUBE  
4.0x40 mm S4

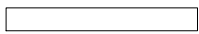

		24	3750	3	WINDBRETT	
---	---	----	------	---	-----------	--

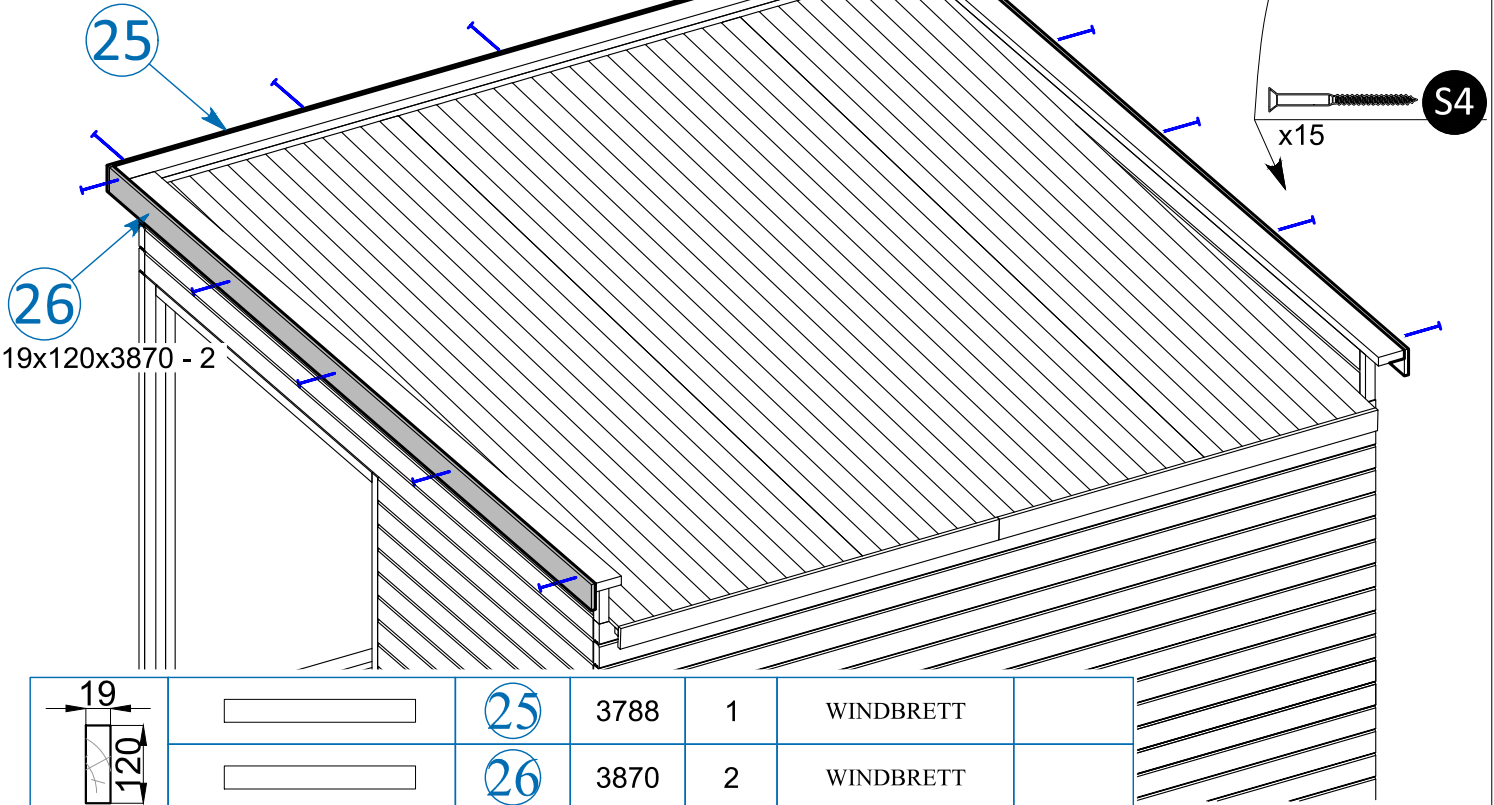
19x120x3788 - 1

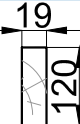

		25	3788	1	WINDBRETT	
		26	3870	2	WINDBRETT	

Vorbohren wird empfohlen.

BODEN MONTAGE

NAGEL  
Lx50 mm

N2

SCHRAUBE  
4.0x40 mm

S4

45x90x707 - 1

SCHRAUBE  
4.5x70 mm

S1

x8x40

N2

x2 S1

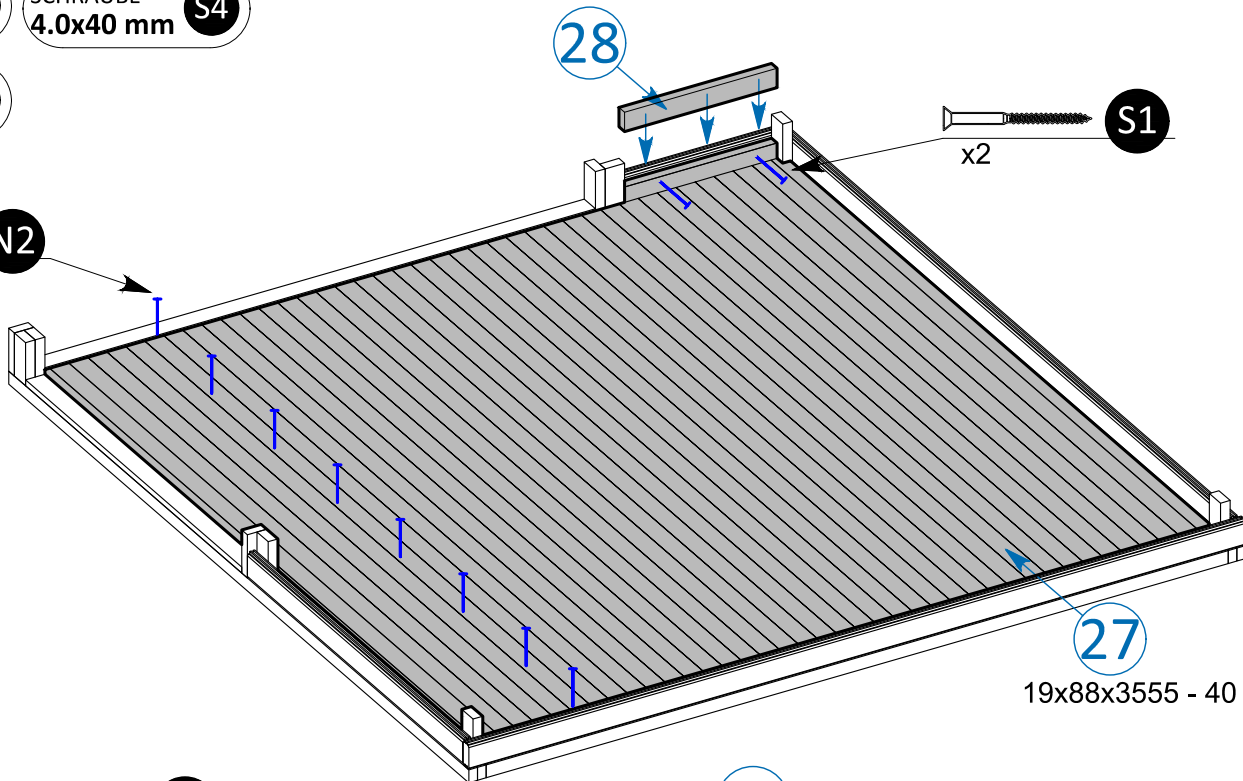

x13 S4

29 25x30x3420- 2

29

30

25x30x1554 - 1

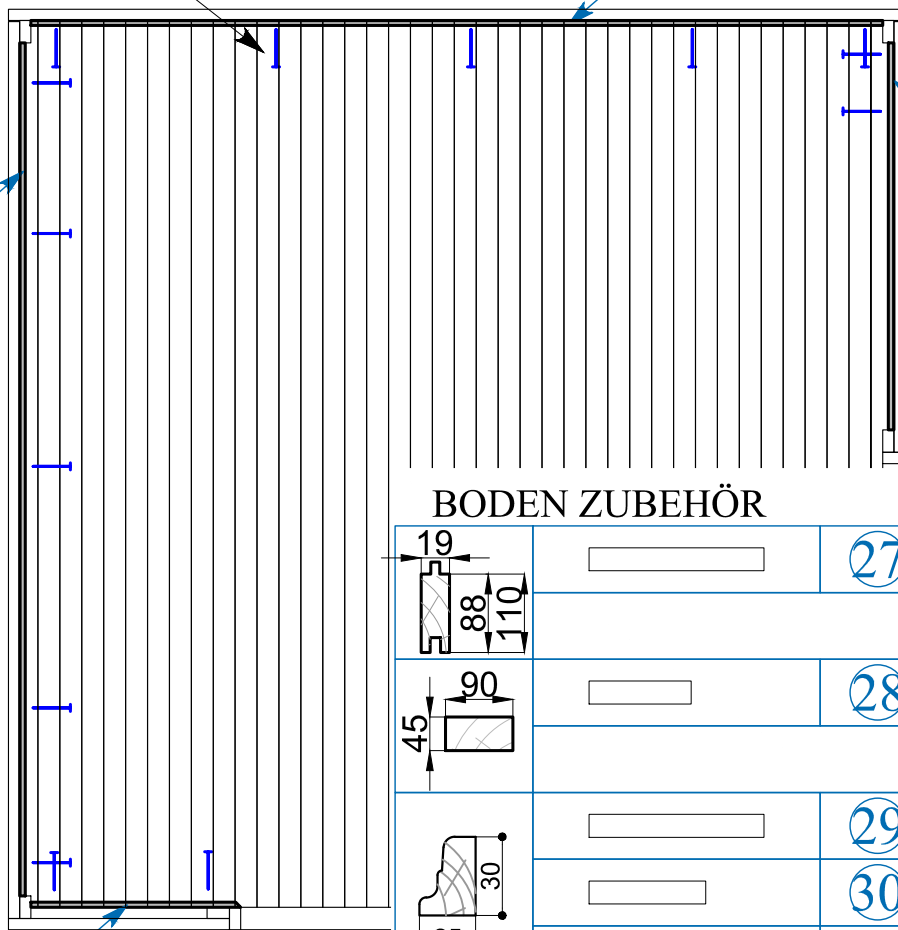

31 25x30x840- 1

BODEN ZUBEHÖR







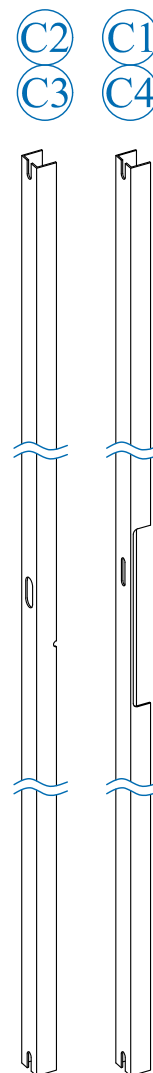
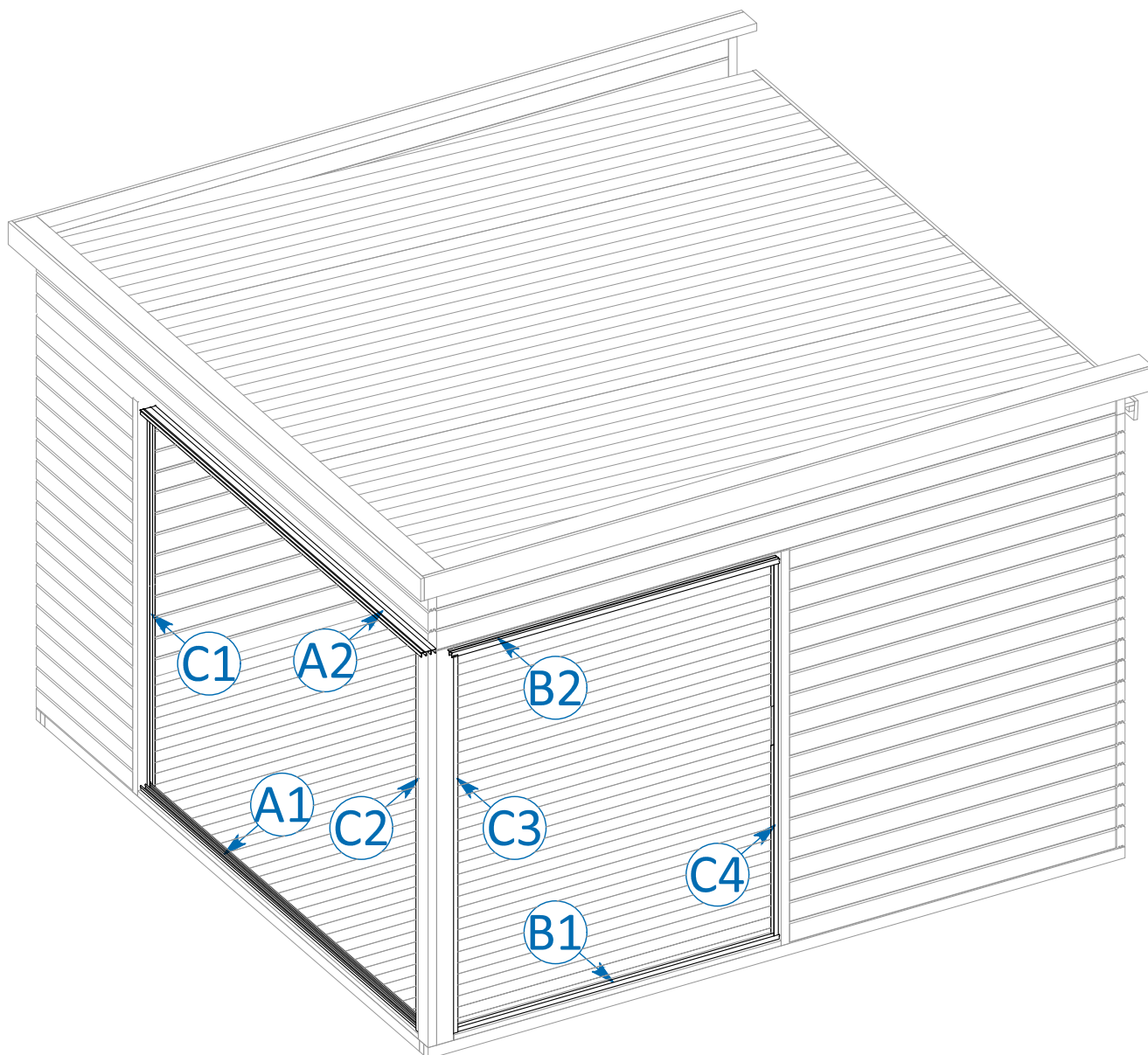





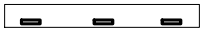

		27	3555	40+1 (32+1)
		28	707	1
		29	3420	2
		30	1554	1
		31	840	1

Vorbohren wird empfohlen.

## SCHIEBETÜRSYSTEM MONTAGE

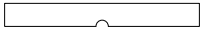

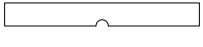
## SCHIEBETÜRSYSTEM ZUBEHÖR

		(A1)	2578	1	UNTERE SCHIENE	
		(A2)	2578	1	OBERE SCHIENE	
		(B1)	1736	1	UNTERE SCHIENE	
		(B2)	1736	1	OBERE SCHIENE	
		(C1)	2000	1	SEITENPROFIL	
		(C2)	2000	1	SEITENPROFIL	
		(C3)	2000	1	SEITENPROFIL	
		(C4)	2000	1	SEITENPROFIL	

Wir empfehlen auch die Verwendung von Dichtungsmaterial zwischen Profilen und Oberfläche, um zu verhindern, dass Regen in das Haus eindringt.

SCHIEBETÜRSYSTEM MONTAGE -1-

SCHRAUBE 4.0x40 mm S4

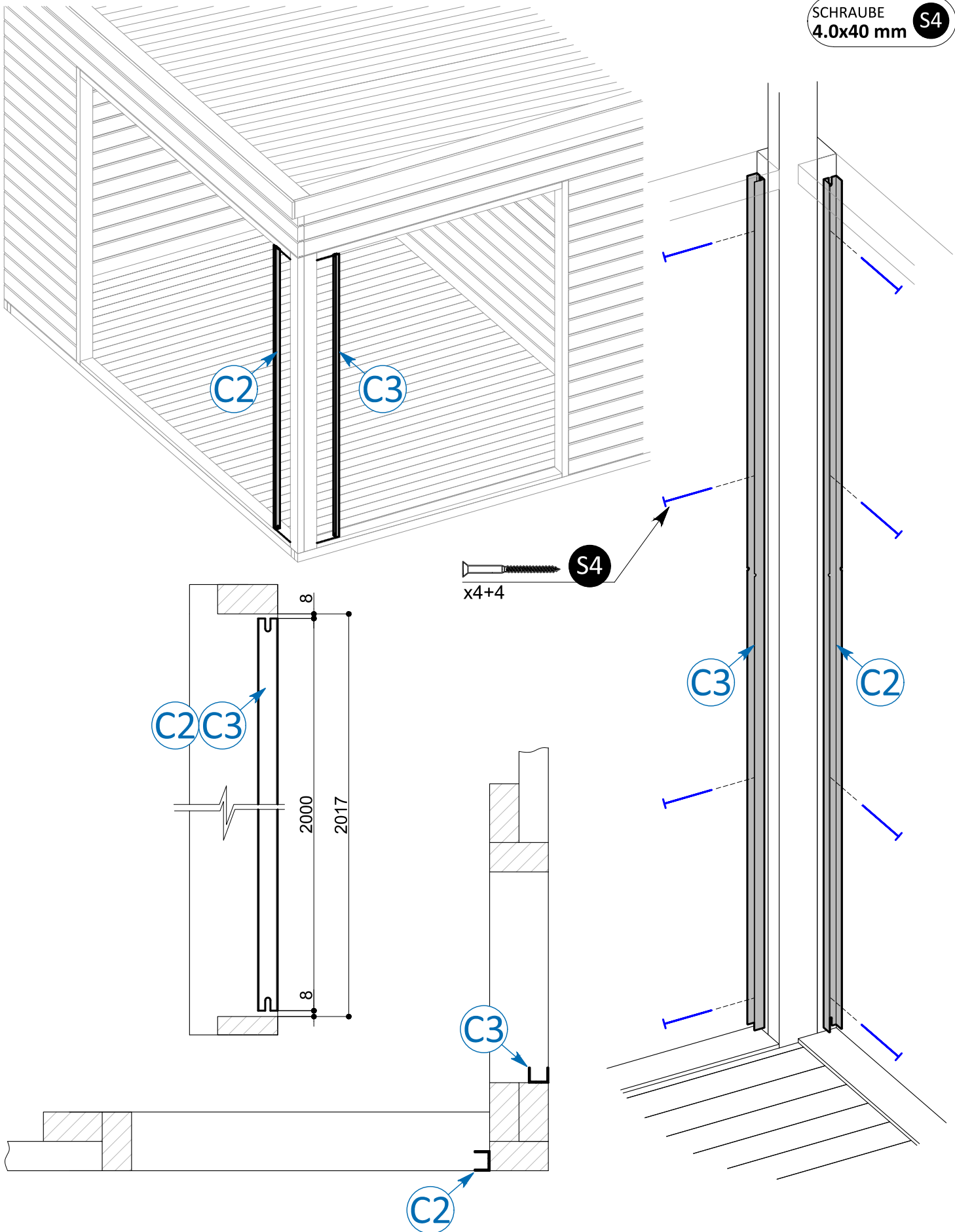

Vorbohren wird empfohlen.



SCHIEBETÜRSYSTEM MONTAGE -2-

SCHRAUBE  
4.0x40 mm S4

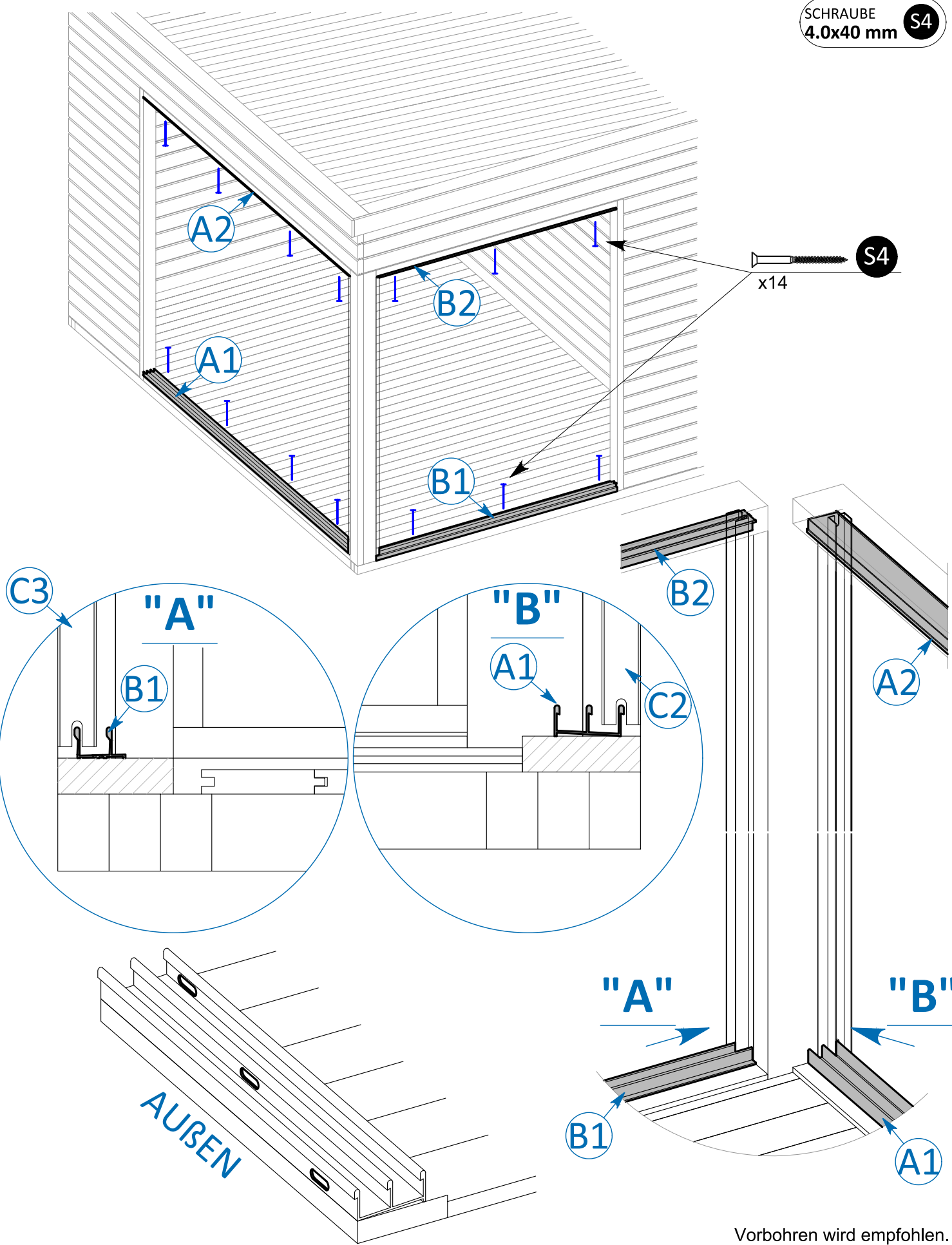

Vorbohren wird empfohlen.

SCHIEBETÜRSYSTEM MONTAGE -3-

SCHRAUBE  
4.0x40 mm S4

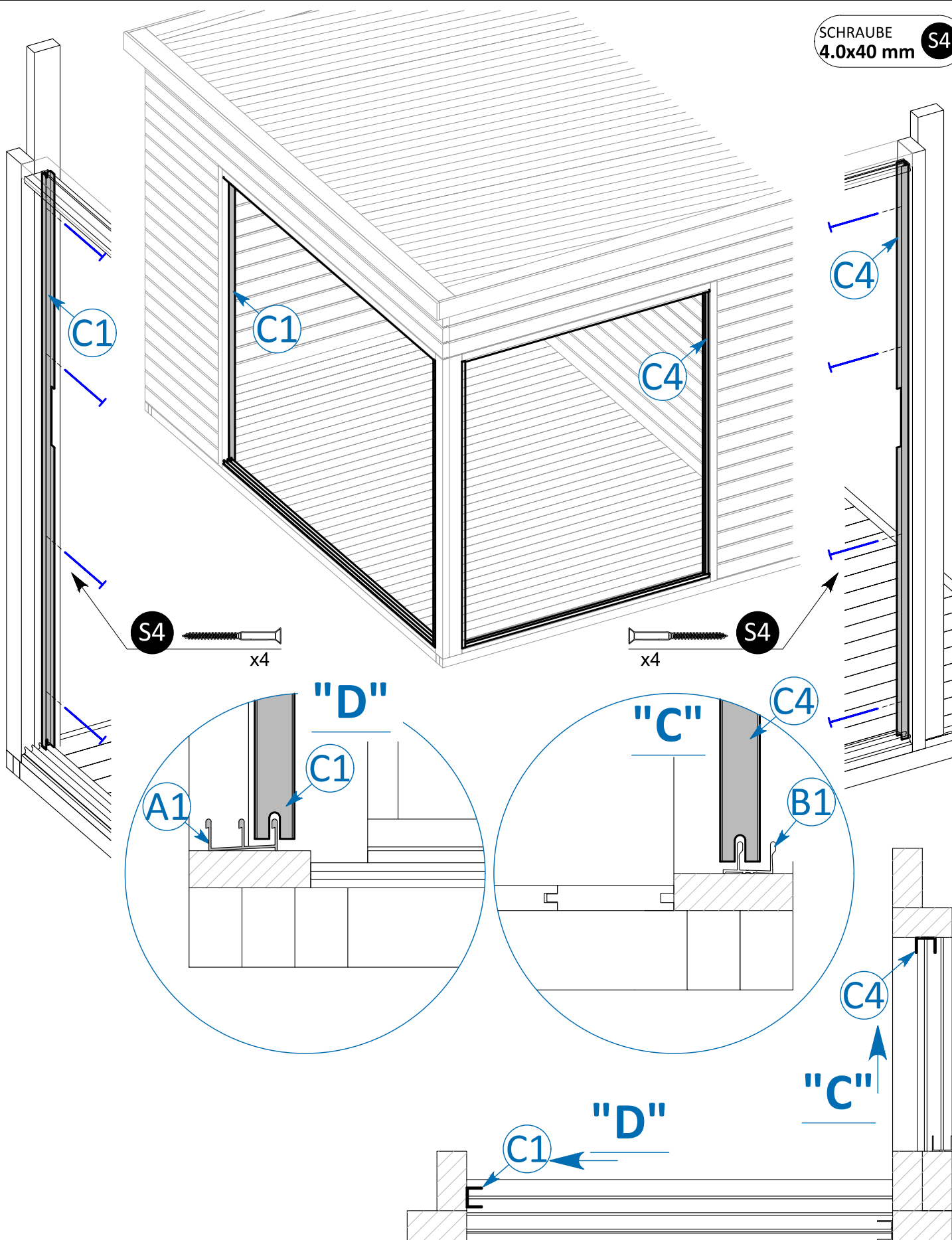

Vorbohren wird empfohlen.

## SCHIEBETÜRSYSTEM MONTAGE -4-

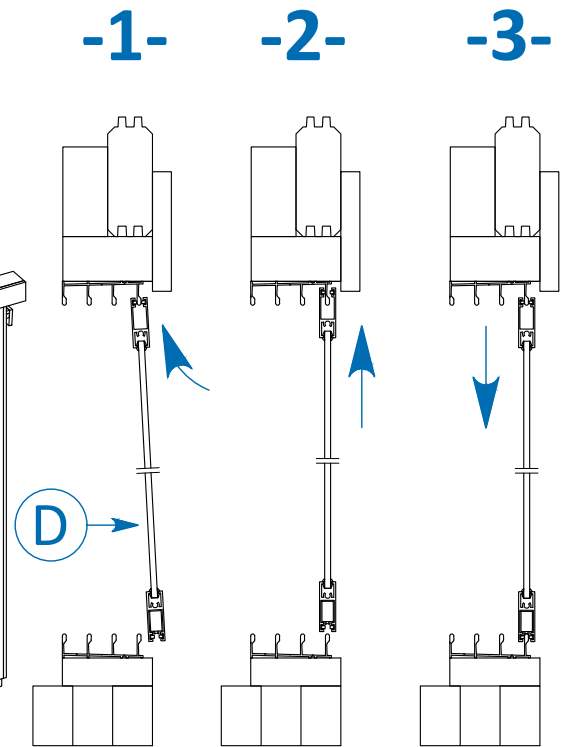
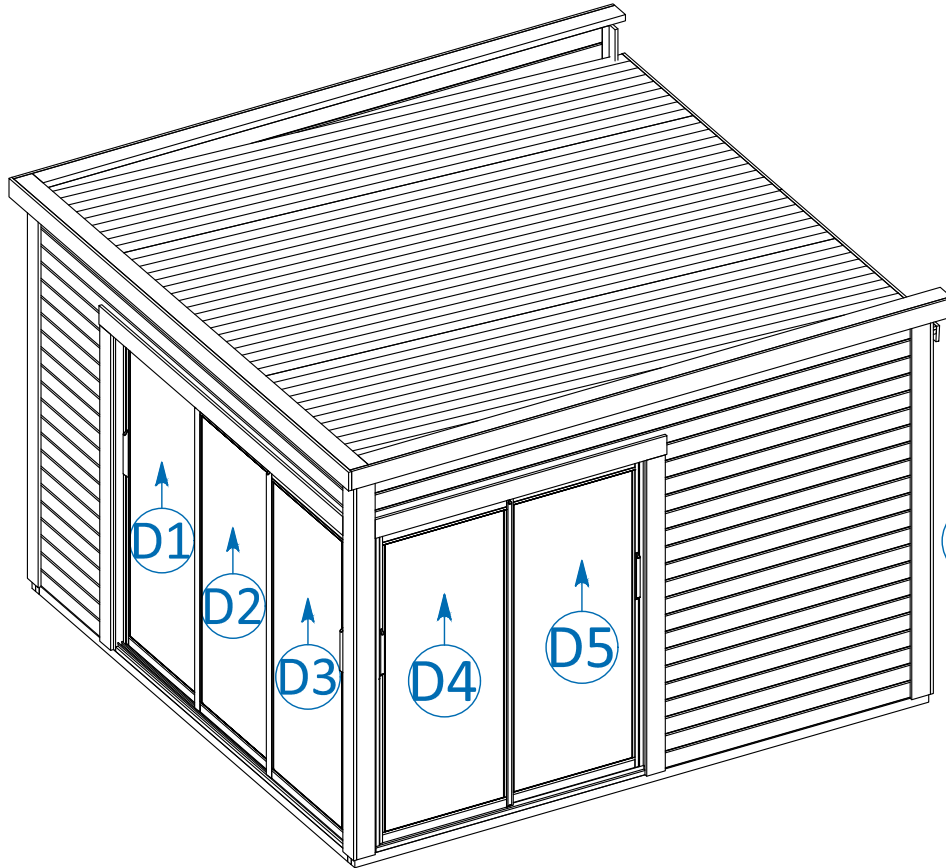

## GLASSCHIEBETÜR ZUBEHÖR

	D1	.	1	GLASSCHIEBETÜR	
	D2	.	1	GLASSCHIEBETÜR	
	D3	.	1	GLASSCHIEBETÜR	
	D4	.	1	GLASSCHIEBETÜR	
	D5	.	1	GLASSCHIEBETÜR	

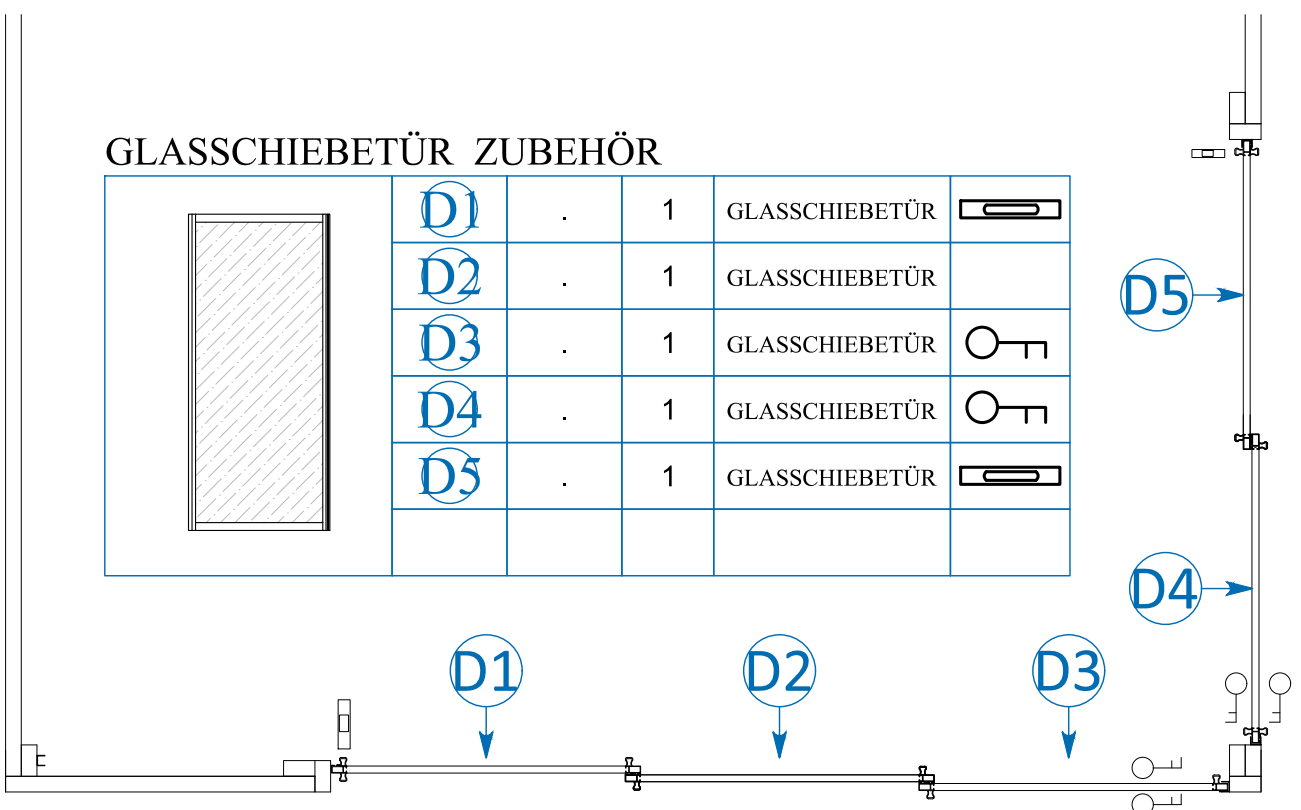

## RAHMENBLENDEN MONTAGE -1-

SCHRAUBE  
4.0x40 mm S4

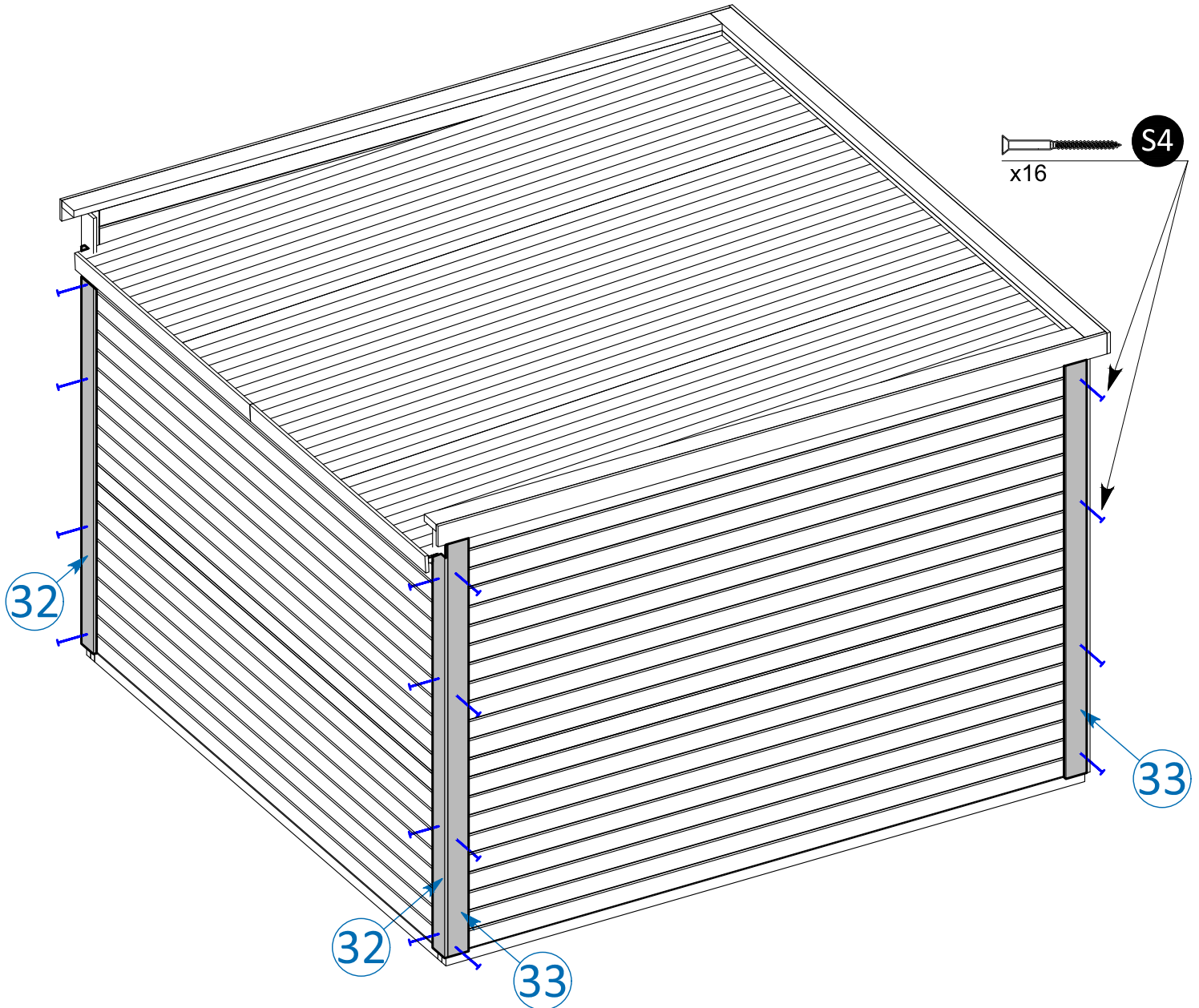

## RAHMENBLENDEN ZUBEHÖR

		32	2300	2	RAHMENBLENDE	
		33	2520	6	RAHMENBLENDE	
		34	2035	2	RAHMENBLENDE	
		35	1880	1	RAHMENBLENDE	
		36	2720	1	RAHMENBLENDE	

SCHRAUBE  
4.0x40 mm S4

