

(D) Montageanleitung

(GB) Assembly instructions

(FR) Notice de montage

(IT) Istruzioni di montaggio

(NL) Handleiding voor de montage

(PL) Instrukcja montażu

(CZ) Montážní návod

(SK) Návod na montáž

(HU) Szerelési útmutató

(RO) Instrucțiuni de montaj

(TR) Montaj talimatı

(RU) Инструкция по монтажу



Ausgabe:20130830

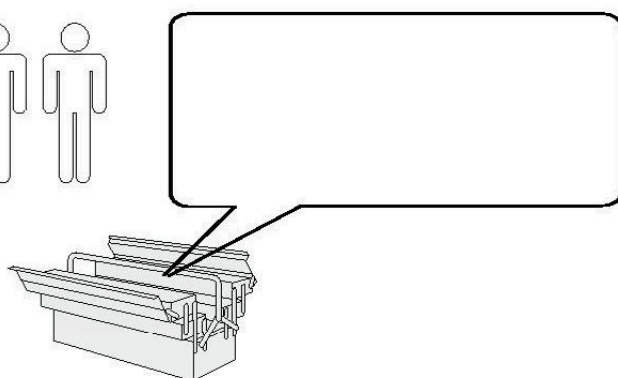
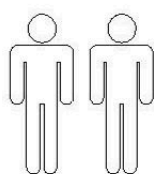

**Service • Assistenza • Dienstverlening • Serwis
Servis • Szerviz • Сервисная служба**

Name • Nom • Nome • Naam Nazwa • Jméno • Názov • Név Denumire • Isim • Название	ROYAL
Nr. • No. • N° • Номер • Č • Sz	5705 8248
Typ • Type • Tip • Típus • Tipo Тип	

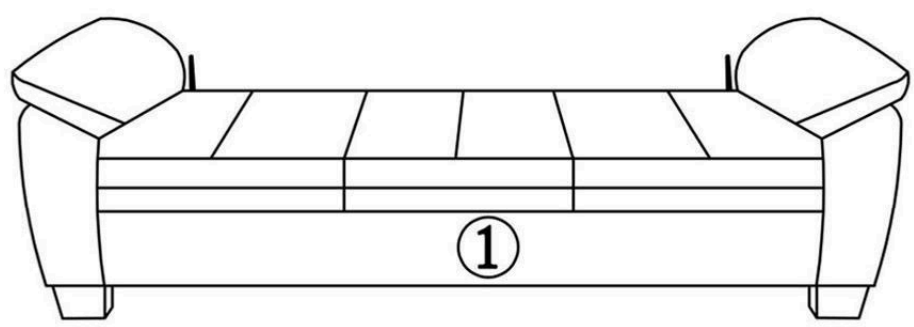
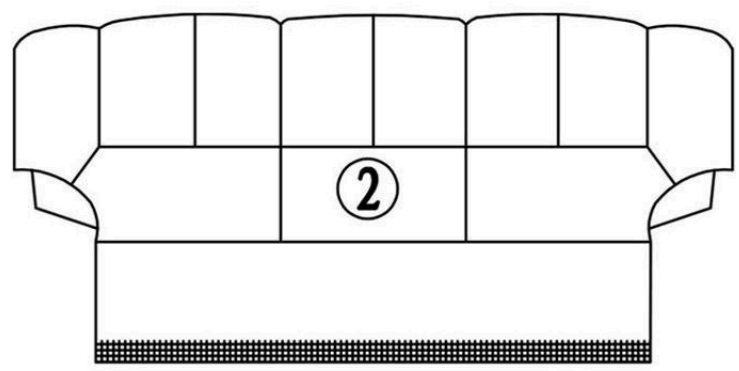
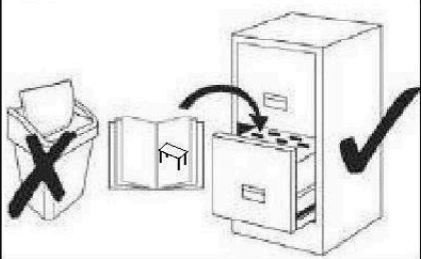
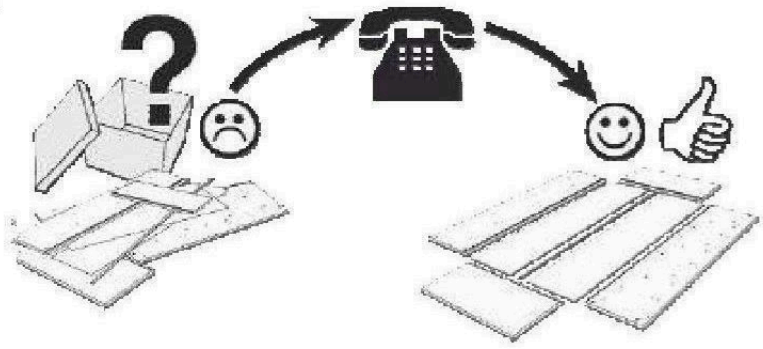

3

- 4 PCS
- 4 PCS
- 4 PCS
- Allen Key 1 PCS
- 5 PCS
- 1 PCS

0
10
20
30
40
50
60
70
80
90
100
110
120
130
140
150
160
170
180
190
200

1

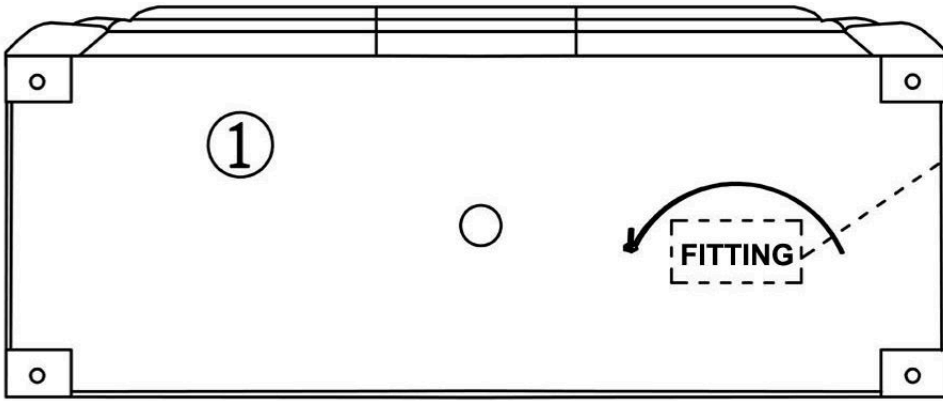

2

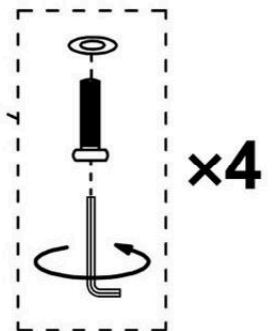
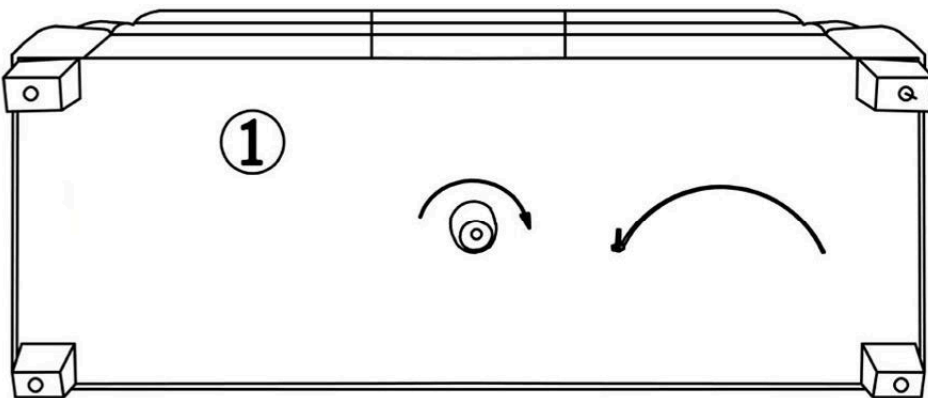

3

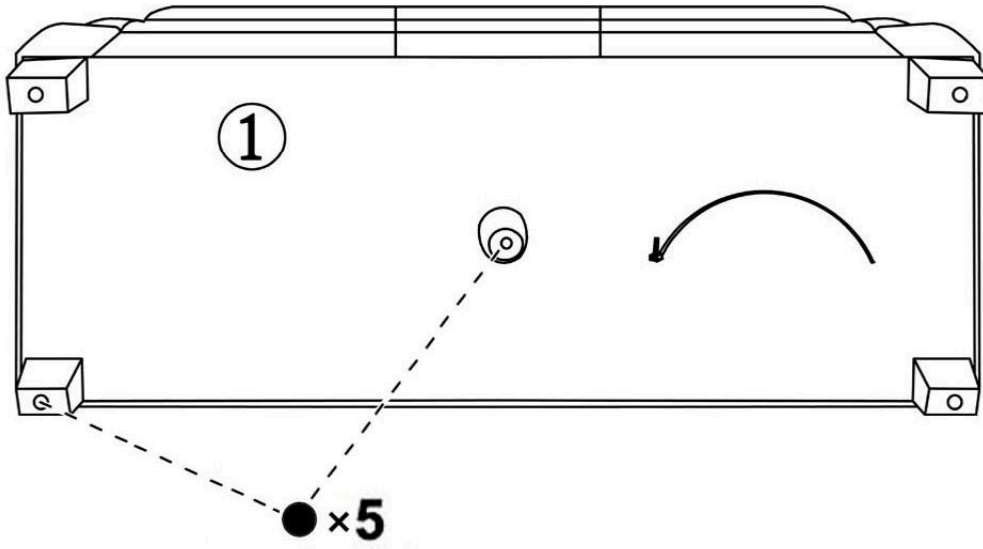

4

