

87020.530

27-06-2012

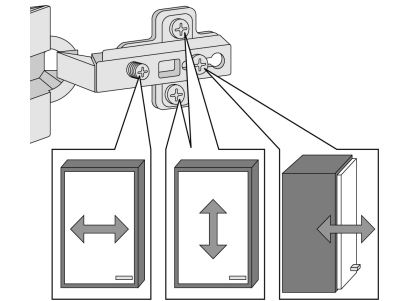

1 8 x	2 8 x 2827	3 2 x 1503	4 2 x 1611	5 1 x
6 2 x	7 2 x	8 4 x 2804	9 4 x 10mm	10 2 x 5mm
11 4 x 2821	12 2 x 2840	13 2 x 2842	14 10 x 2862	15 1 x 2865
		24 8 x 2861	25 1 x 2863	

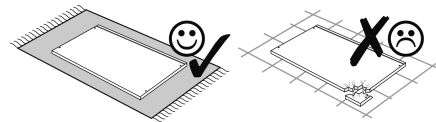
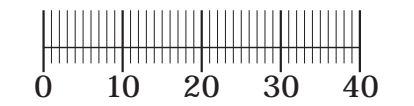
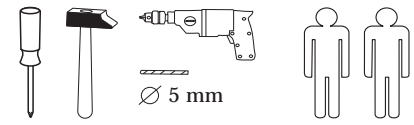
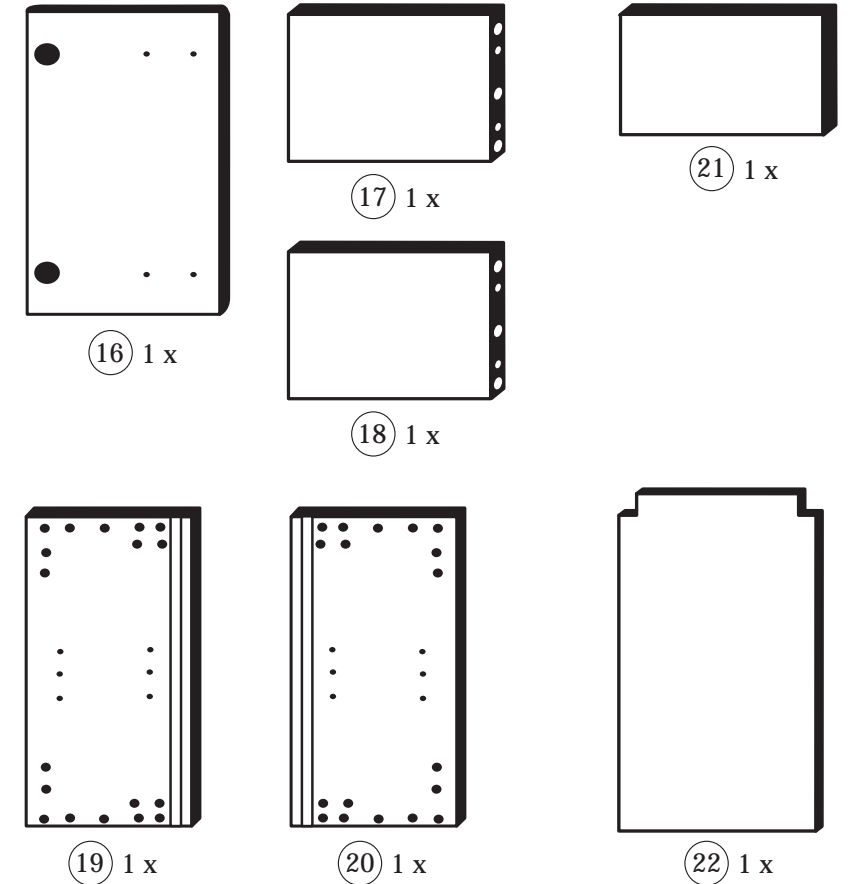

Das beigelegte Wandbefestigungsmaterial (Dübel und Schrauben) eignet sich nur für festes Mauerwerk (z.B.: Beton- oder Ziegelwände). Für andere Wandaufbauten sind eventuell Spezialdübel und andere Schrauben notwendig. Ziehen Sie gegebenenfalls eine Fachkraft zu Rate.

De begeleidende wandmontage hardware (pluggen en schroeven) is alleen geschikt voor massief metselwerk (bijvoorbeeld beton of bakstenen muren). Voor andere muur structuren zijn eventueel bijzondere ankerbouten en andere noodzakelijke. Draai indien nodig, een deskundige.

Приложенный материал для крепления к стене (дюбели и винты) пригоден только для жестких кладок (например, бетонные или кирпичные стены). Для других настенных конструкций необходимы смотря по обстоятельствам специальные дюбели и другие винты. При необходимости проконсультируйтесь у специалиста.

Le mur d'accompagnement matériel de montage (chevilles et les vis) ne convient que pour la maçonnerie solide (par exemple en béton ou des murs de briques). Pour les structures de mur d'autres sont peut-être spéciale boulons d'ancrage et d'autres nécessaires. Serrer le cas échéant, un expert.

Załączony materiał do mocowania do ściany (kolki rozprężne i wkręty) nadaje się tylko do ścian murowanych (np. z betonu lub cegieł). Do ścian wykonanych w innych technologiach konieczne być mogą specjalne kolki rozprężne i inne wkręty. W razie potrzeby skorzystaj z fachowej pomocy.

Il muro di accompagnamento hardware di montaggio (tasselli e viti) è adatto solo per muratura piena (ad esempio calcestruzzo o muratura). Per le altre strutture murarie sono forse speciali bulloni di ancoraggio e necessari di altri. Serrare se necessario, un esperto.

The accompanying wall mounting hardware (anchors and screws) is suitable only for solid masonry (eg concrete or brick walls). For other wall structures are possibly special anchor bolts and other necessary. Tighten if necessary, an expert.

Ekteki duvara sabit montaj malzemeleri (dübel ve vidalar), sadece sağlam duvarlar için (örnek: beton veya tuğla) elverişlidir. Başka duvarlar için özel dübeller ve farklı vidalar gerekebilir. Gerektiğinde bir bilene danışınız.

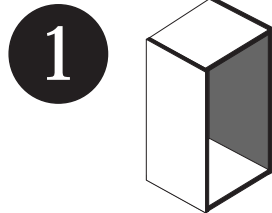

4 2 x 1611	11 4 x 2821	9 4 x 10mm	13 1 x 2880	14 1 x 2881
------------------	-------------------	------------------	-------------------	-------------------

Bitte beachten!
 In dieser Aufbauanleitung ist die Tür rechts angeschlagen.
 Soll die Tür links angeschlagen werden, müssen die Kreuzmontageplatten 4 auf das linke Seitenteil 19, und die Scharniere 3 in die gegenüberliegenden Bohrungen montiert werden.

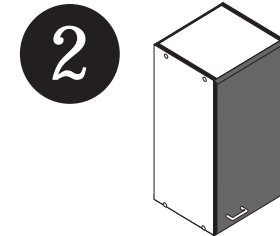
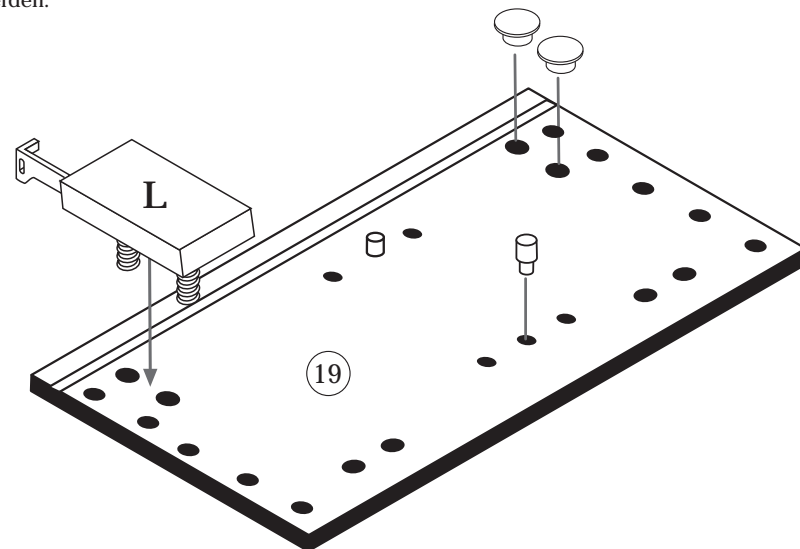

3 2 x 1503	15 1 x 2865
8 4 x 2804	

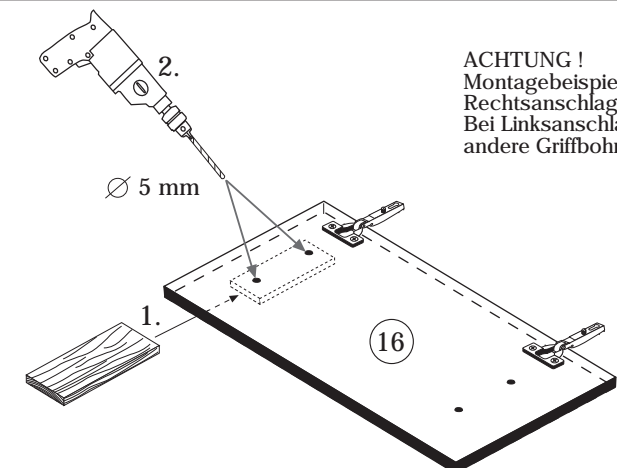
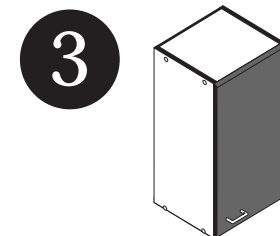
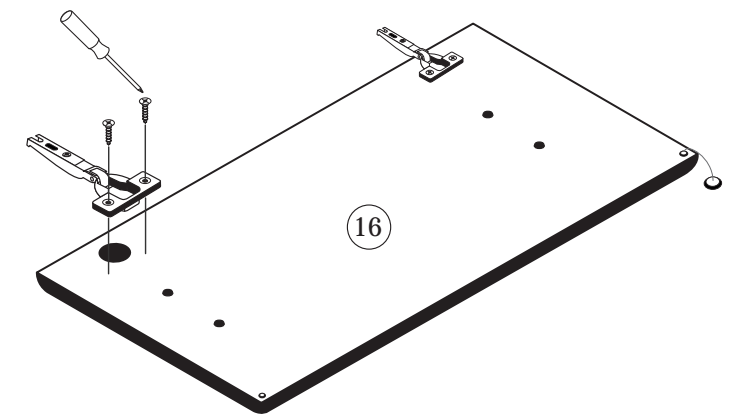

ACHTUNG!
 Montagebeispiel
 Rechtsanschlag!
 Bei Linksanschlag
 andere Griffbohrung durchbohren!

4

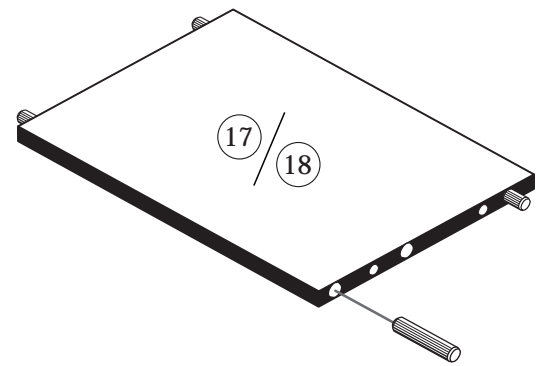
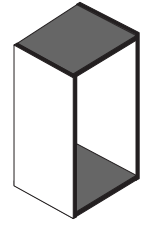

8 x 30	1 x
24	2861
8 x	
25	2863
20 min.	
D Leim	
GB Glue	
NL Lijm	
PL Klej	
TR Tutkal	
F Colle	
I Colla	

7

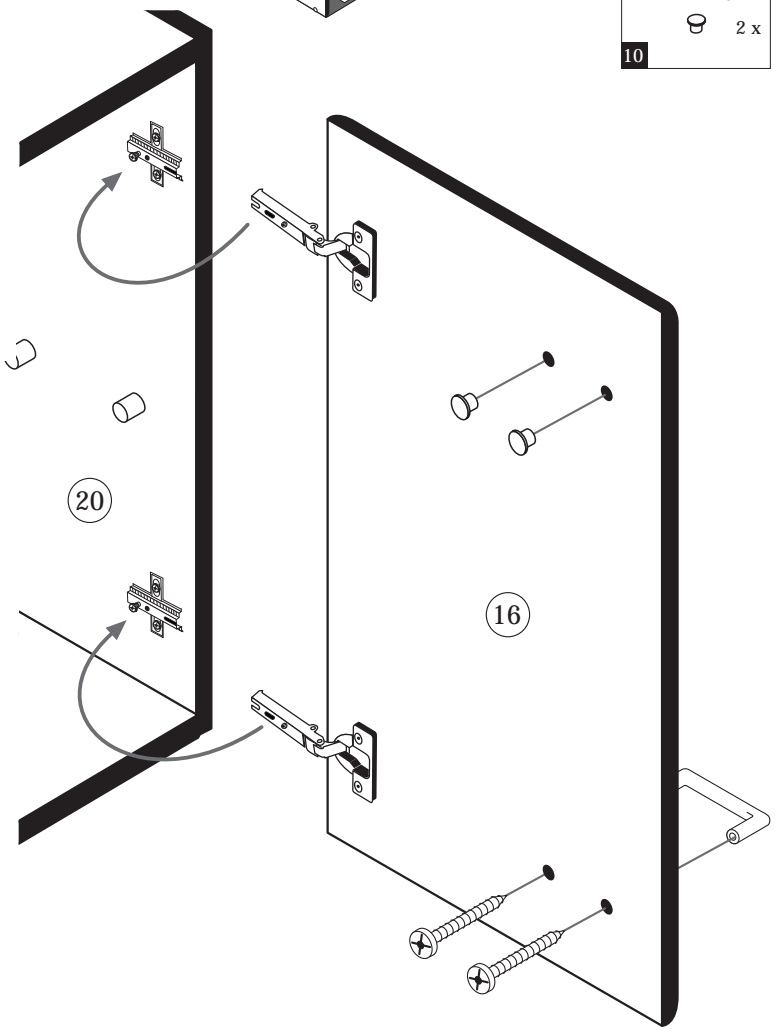
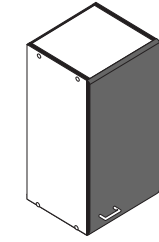

5	1 x
6	2 x
5mm	
10	2 x

8

5,8 x 55	8 x 30
12	2840
2 x	2 x
2842	

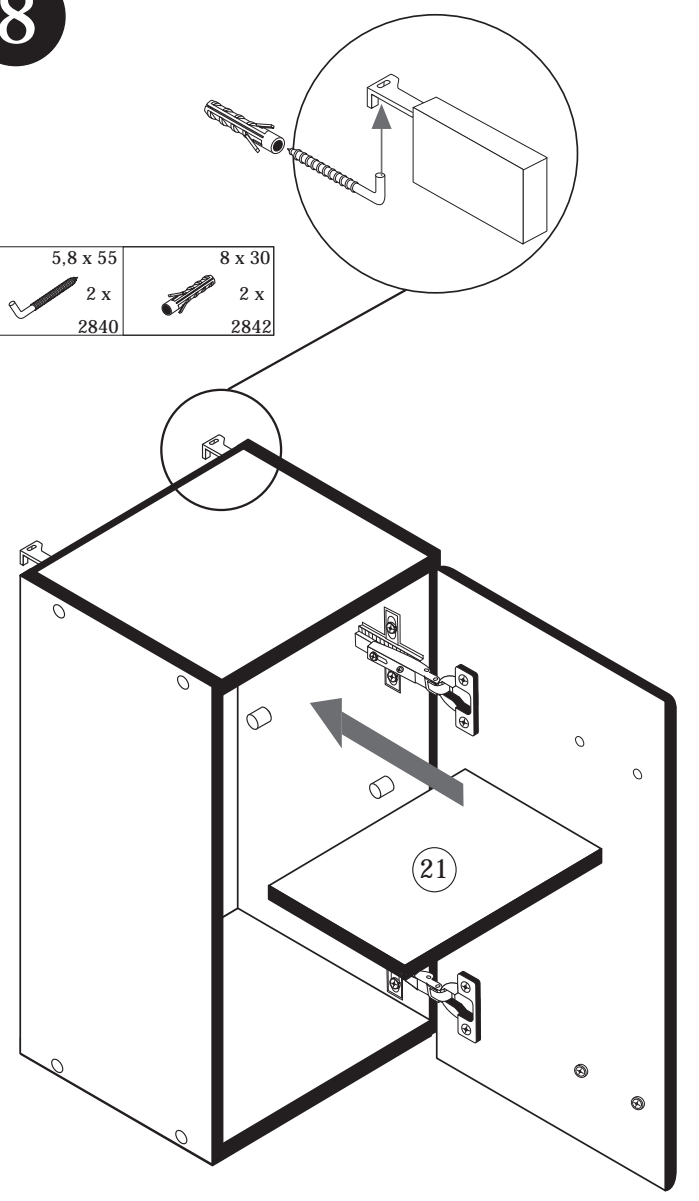

5

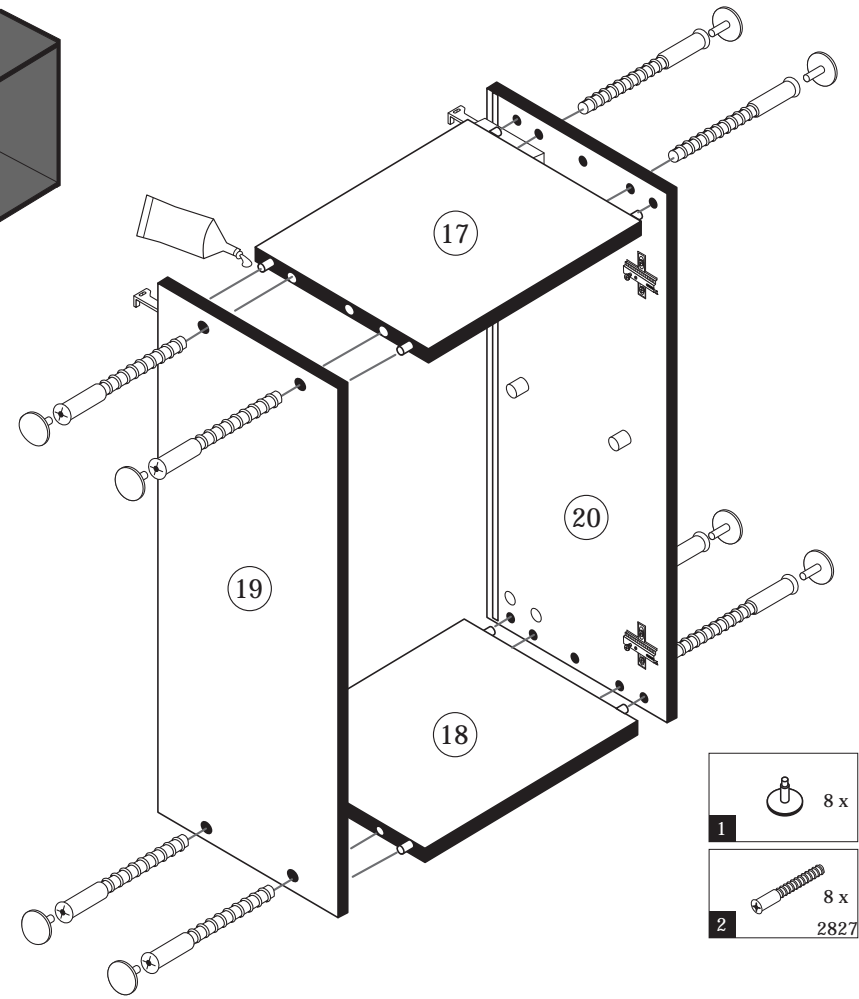
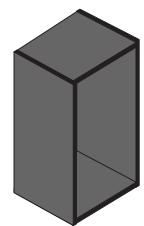

1	8 x
2	8 x
2827	
25	1 x
2863	
20 min.	
D Leim	
GB Glue	
NL Lijm	
PL Klej	
TR Tutkal	
F Colle	
I Colla	

9

4 x 9	5 x 30
7	2 x
	1 x

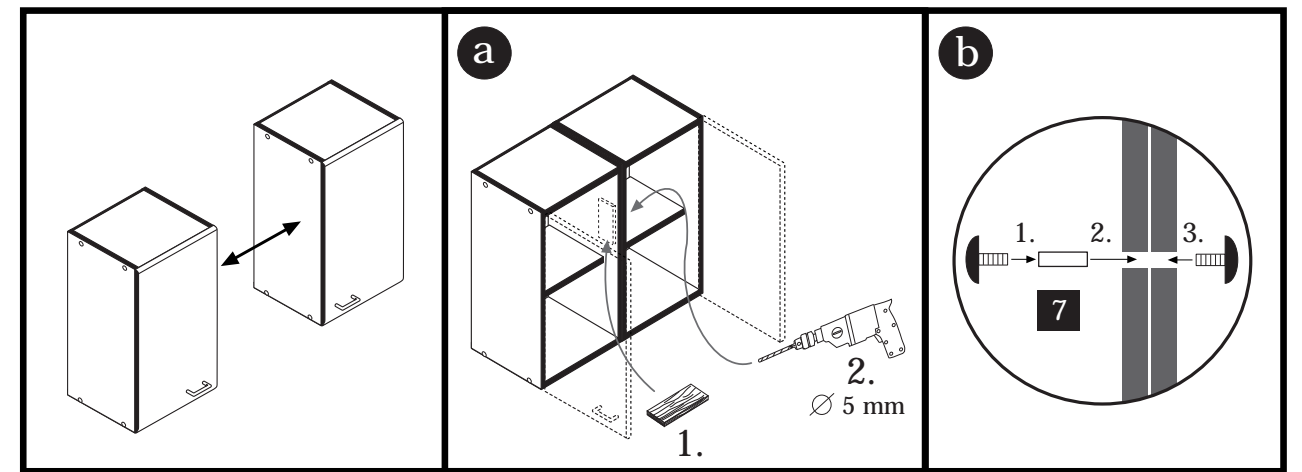

6

10 x
14
2862

