

1/11

→||←40mm

3,9 x 5,8

**40013**

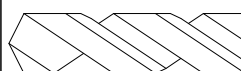
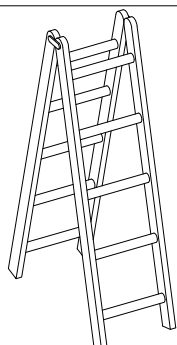
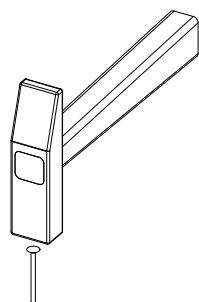
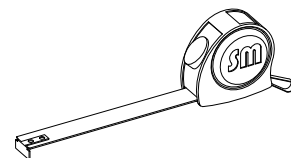
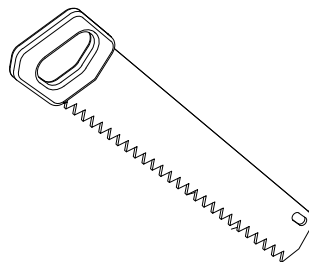
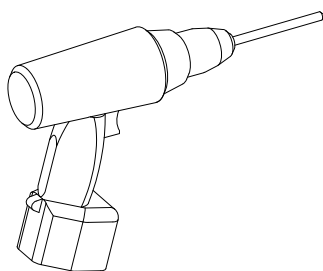
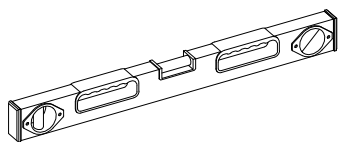
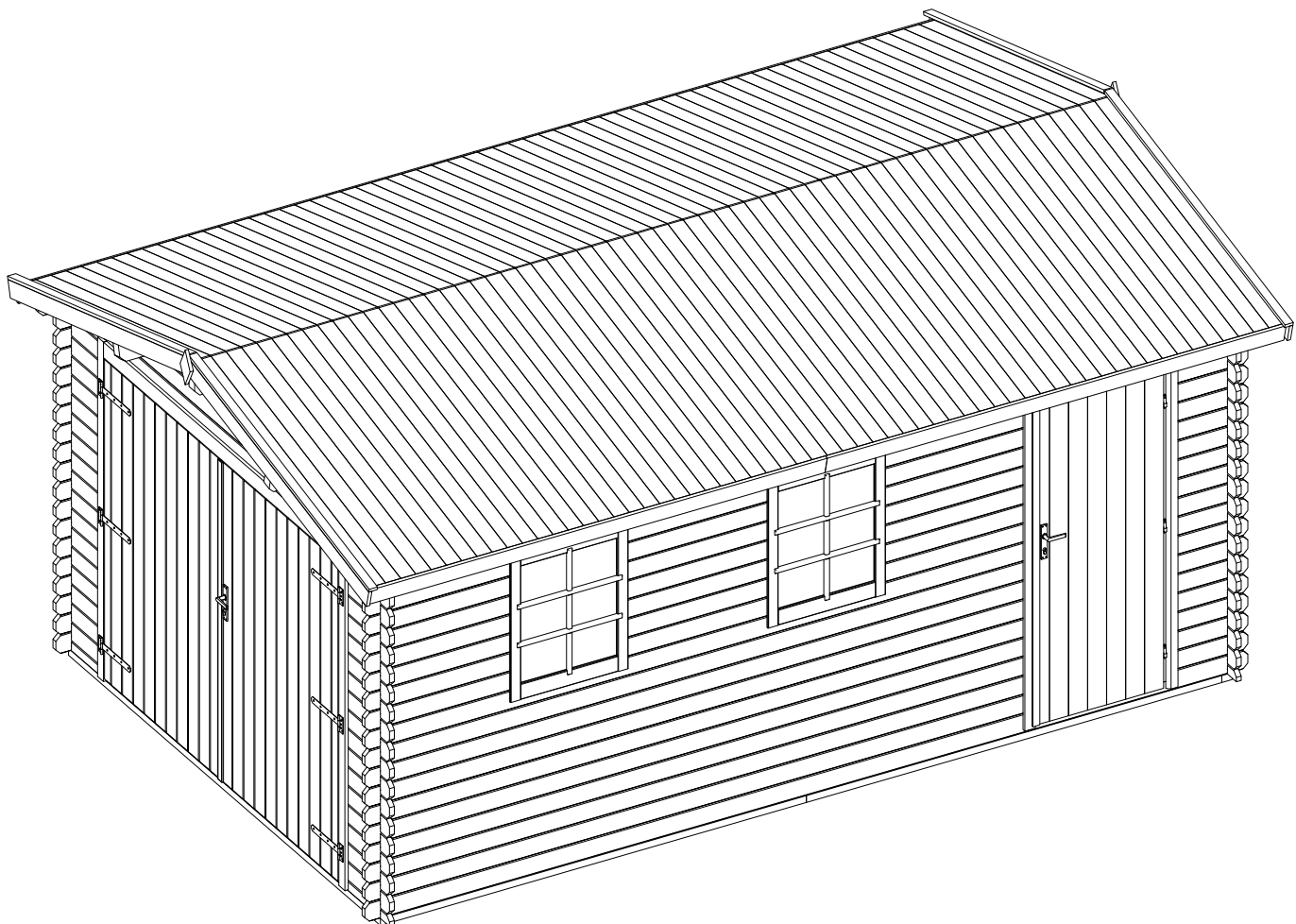







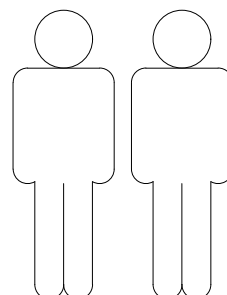
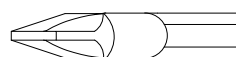

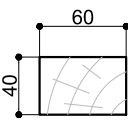
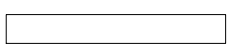
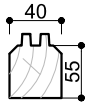

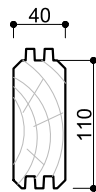

Ø4

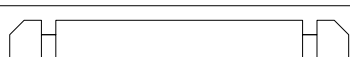
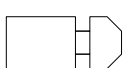

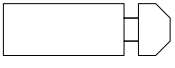

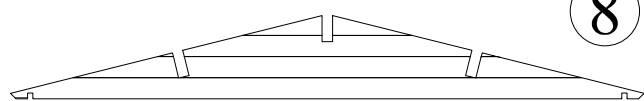
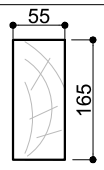

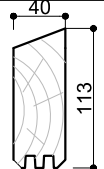
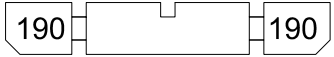
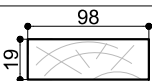
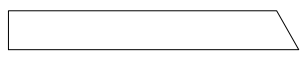
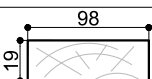
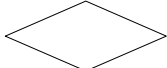
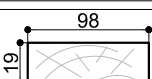
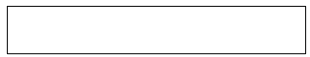

Ø10

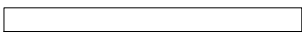
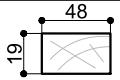

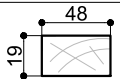
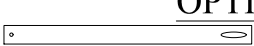
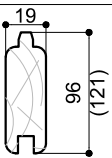

Dim.	Skizze, Dessin, Sketch	Pos.	Länge, Longueur, Length, mm	Stck/ Qté.	Name, Nom, Name	Ref.
		Ⓐ	3720	2	Fundamentbalken	283009
		Ⓑ	2750	4	Fundamentbalken	283060
		①	3900	2	Front/zurück Brett	400013
		②	5800	18	Seiten Brett	400078
		②a	5800	1	Seiten Brett	400073
		②b	5800	1	Seiten Brett	400076
		③	3900	19	Front/zurück Brett	400014
		④	742	34	Front Brett	400072
		⑤	4047	9	Seiten Brett	400074
		⑥	928	23	Seiten Brett	400075
		⑦	928	14	Seiten Brett	400077
	⑧	3900	3	Front/zurück Brett	402012	
		⑨	6000	3	Strahl	404024
		⑩	6000	2	Seiten Brett	401017
		⑪	2090	4	Wind Brett	285061
		⑫	200	2	Decor	286990
		⑬	3000	4	Wind Brett	286038

Alle maßen ca +/-3%

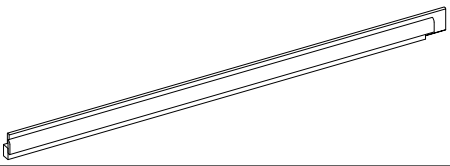
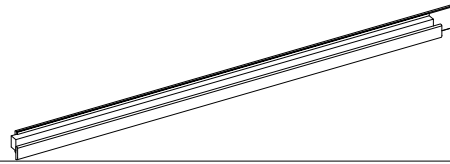
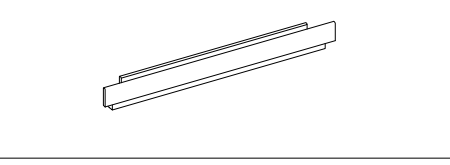
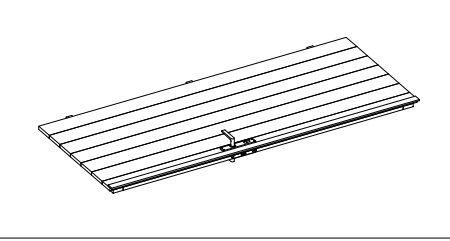
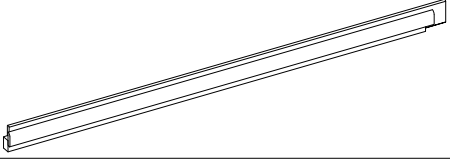
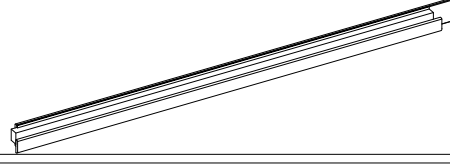
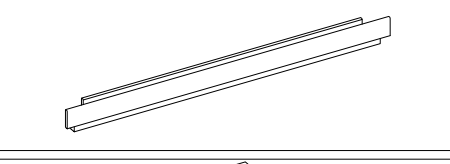
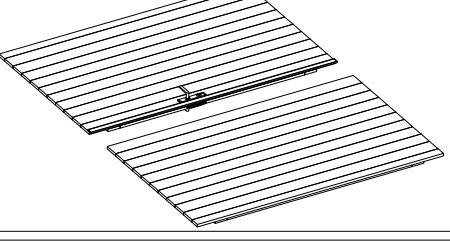
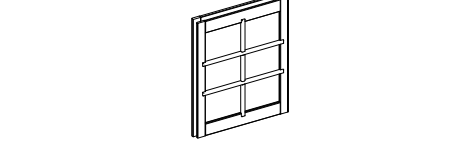
		14	3000	4	Wind Brett	286039
		15	2090	4	Wind Brett	286522
		!	2140	4	Latte	286804
		10	2050	136 (110)	Dachbretter	284502
		17	1835	1	Latte	287106

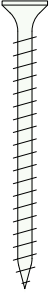
Skizze, Dessin, Sketch	Pos.	Länge, Longueur, Length,mm	Stck/ Qté.	Name, Nom, Name	Ref.
	TR1	1940	1	Türrahmen links Cadre de porte gauche Door frame left	409216
	TR2	1940	1	Türrahmen rechts Cadre de porte droite Door frame right	409217
	TR3	910	1	Über Türrahmen Montant supérieur Door frame top	409218
	T	1845x 760	1	Tür Porte Doors	289013
	GR1	1960	1	Türrahmen links Cadre de porte gauche Door frame left	409213
	GR2	1960	1	Türrahmen rechts Cadre de porte droite Door frame right	409214
	GR3	2405	1	Über Türrahmen Montant supérieur Door frame top	409215
	G1	1845x 1170	1	Tür Porte Doors	289009 G1
	G2	1845x 1170	1		289009 G2
	F	700x880	2	Fenster Fenêtre Window	289101

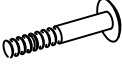
	Pos.	Dim	Qté.
	<b>A</b>	Ø5.0 x 100	8
	<b>B</b>	Ø3.5 x 40	104
		Ø3.0 x 25	4
	<b>C</b>	Ø2.0 x 40	410

	M8 x 60	4
		8
	M8	4

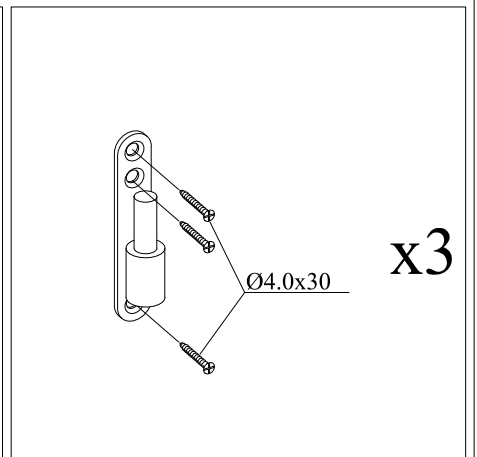
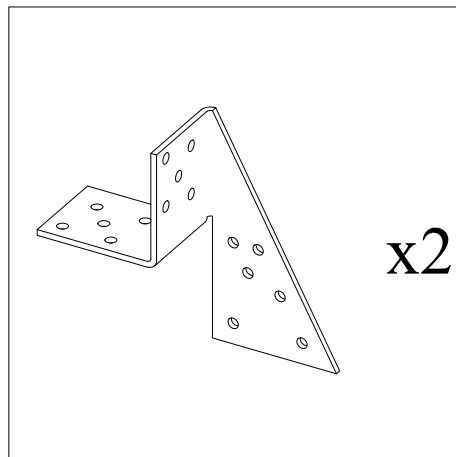
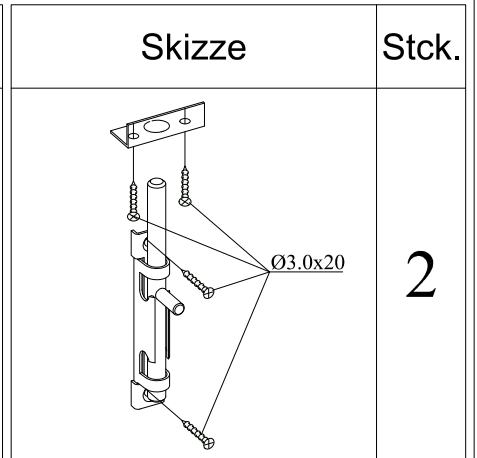
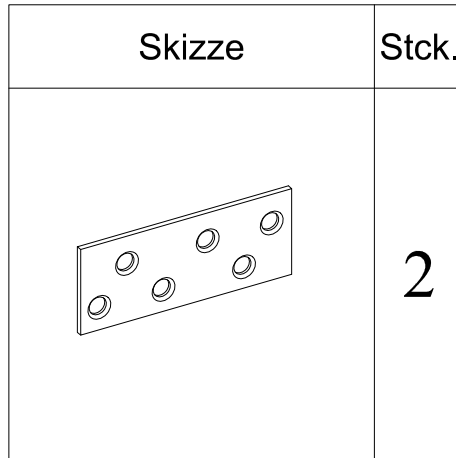
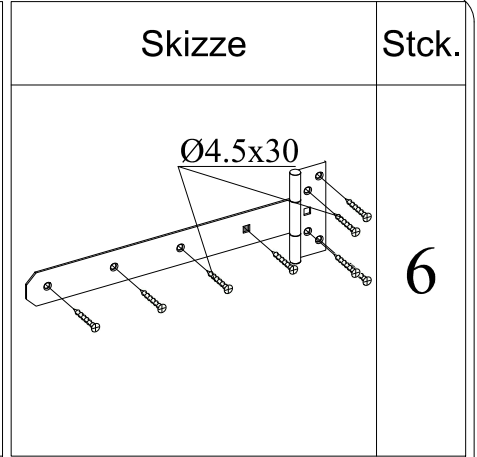
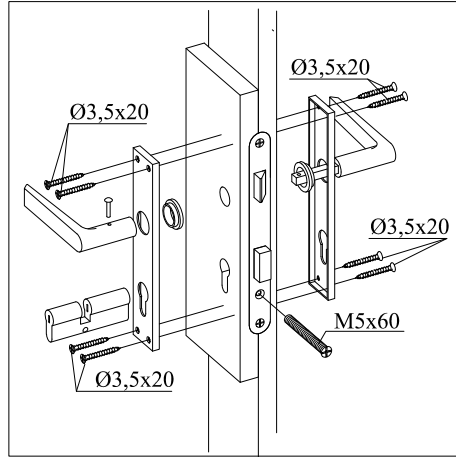

1

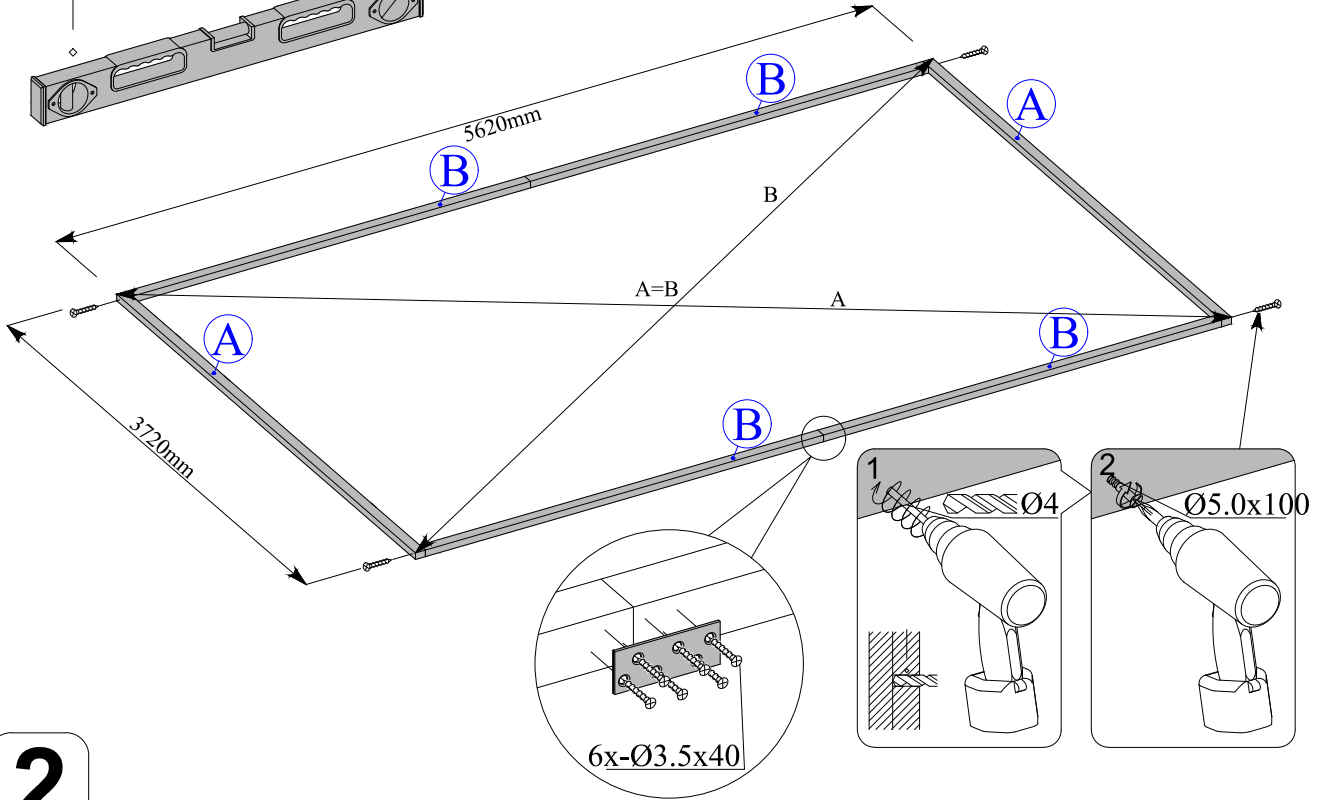
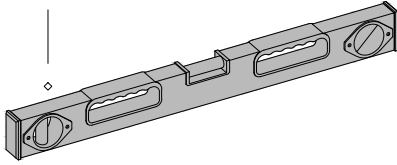
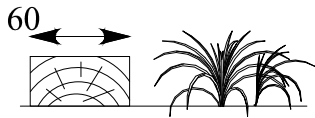

2

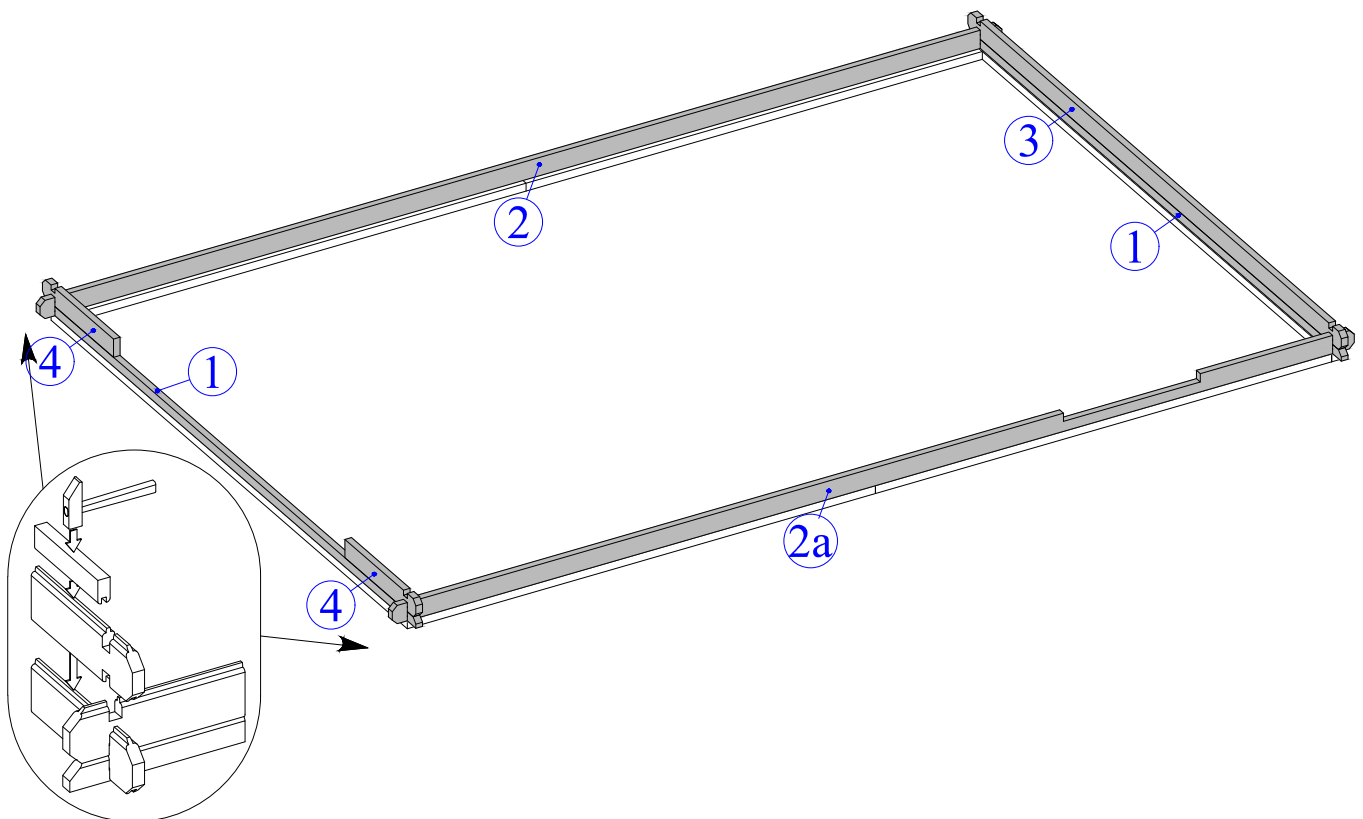

3

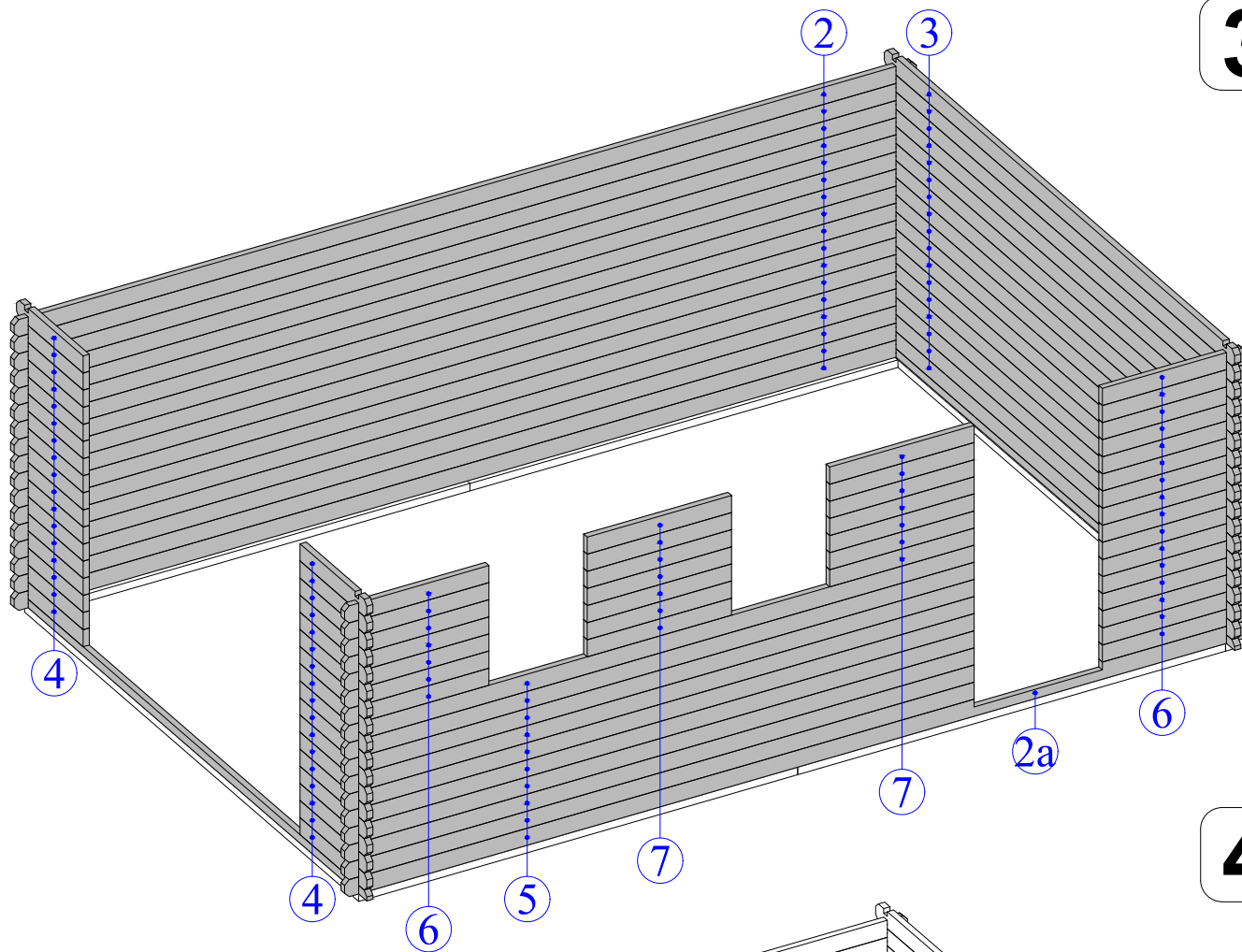

4

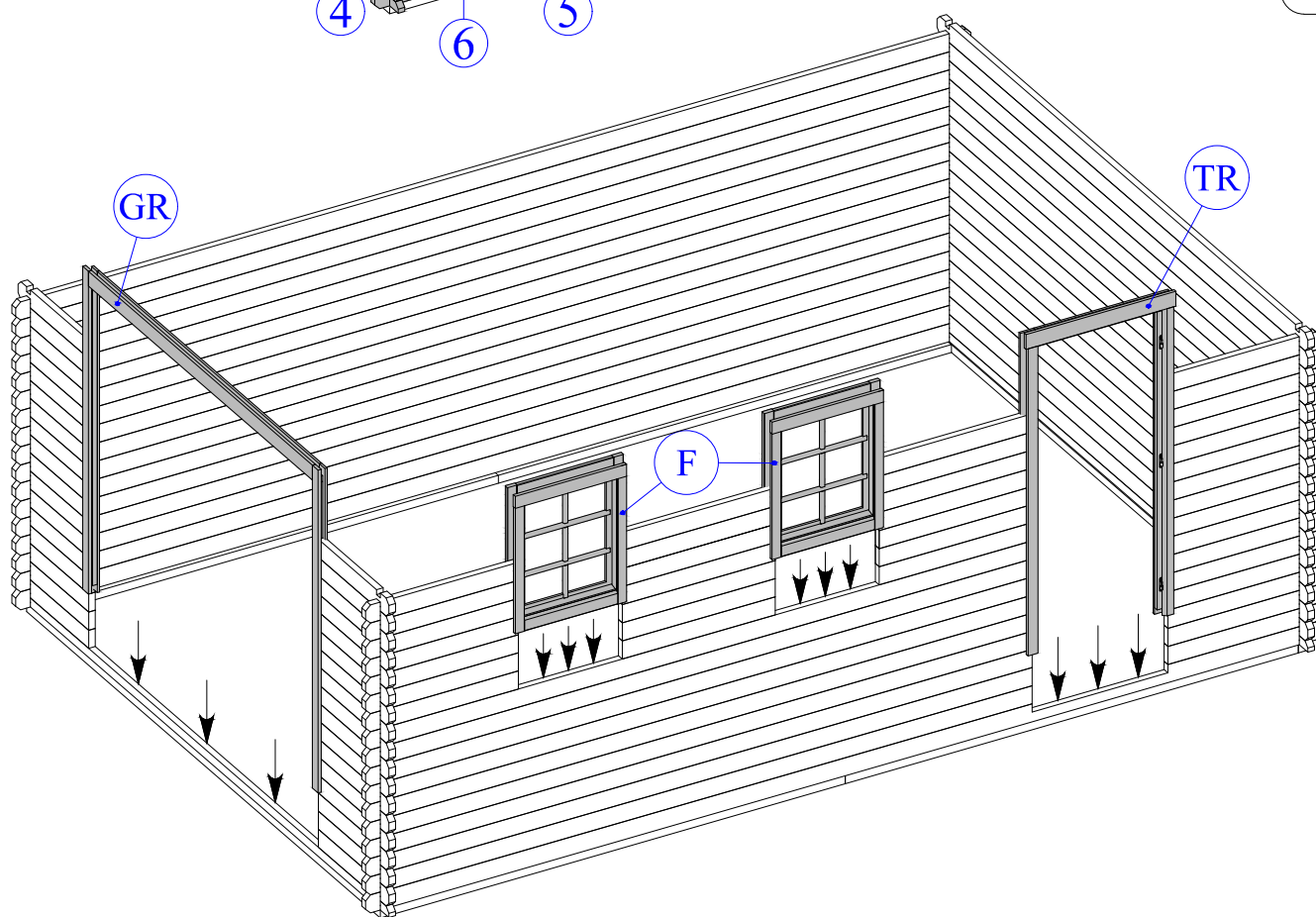

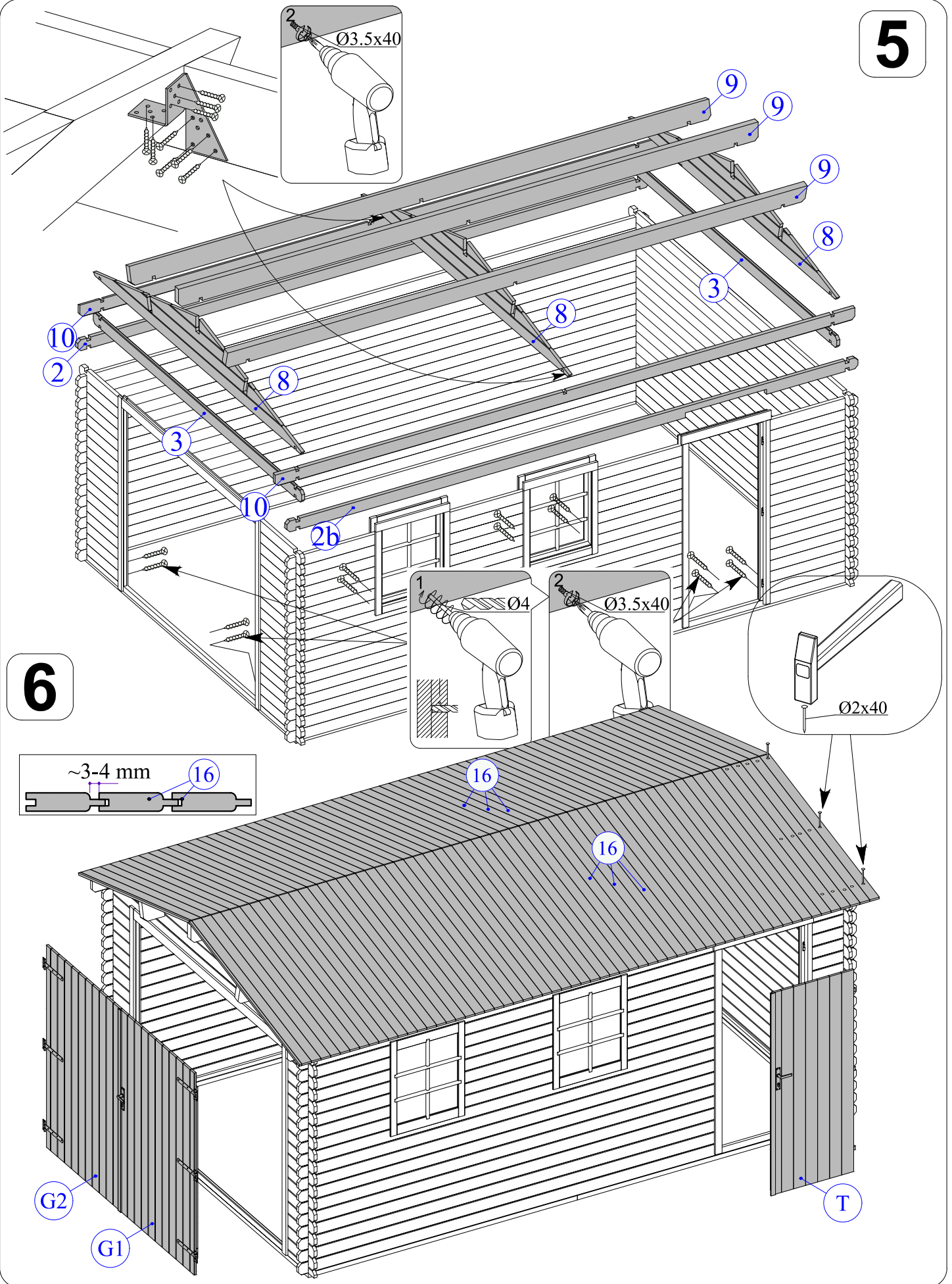



7

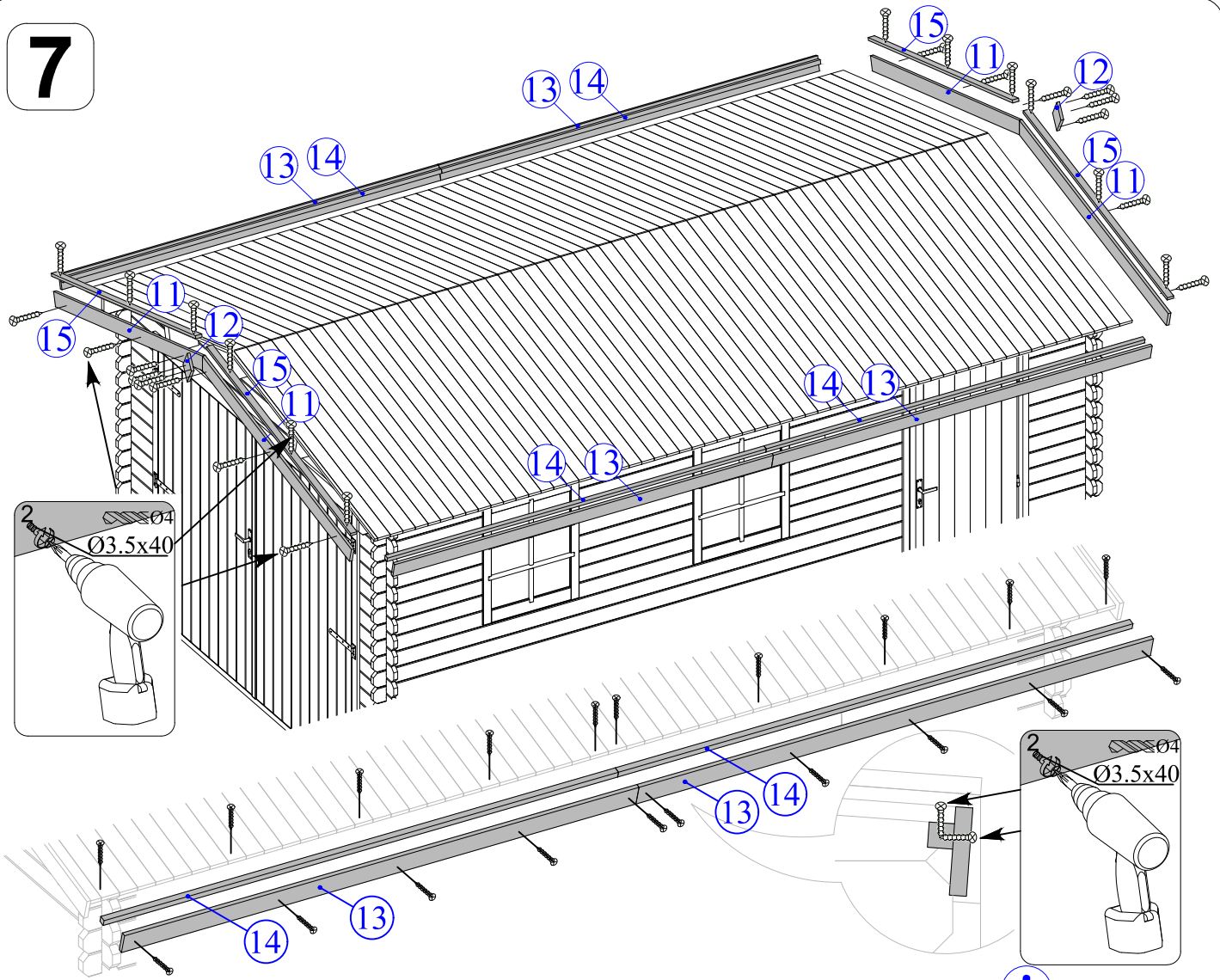

8

