

Art.Nr 5293 9528, 8152 6629

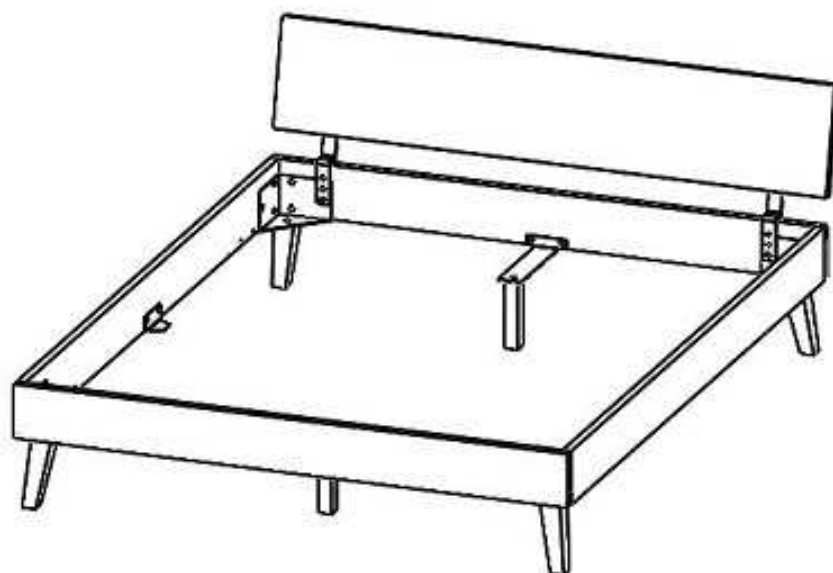

- | | |
|----------------------------------|------------------------------|
| (D) Montageanleitung | (GB) Assembly instructions |
| (FR) Notice de montage | (IT) Istruzioni di montaggio |
| (NL) Handleiding voor de montage | (PL) Instrukcja montażu |
| (CZ) Montážní návod | (SK) Návod na montáž |
| (HU) Szerelési útmutató | (RO) Instrucțiuni de montaj |
| (TR) Montaj talimatı | (RU) Инструкция по монтажу |

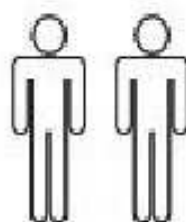

60 min

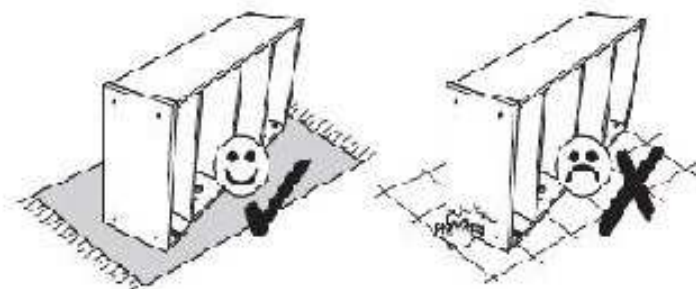



Service • Assistenza • Dienstverlening • Servis Servis • Szerviz • Сервисная служба	
Name • Nom • Nome • Naam • Nazwa • Jméno • Назов • Név • Denumire • İsim • Название	
Nr. • No. • N° • Номер • C • Sz	
Typ • Type • Tip • Tipus • Tipo • Тип	



- D Allgemeiner Sicherheitshinweis:**
Nicht mehr benötigte Verpackungsmaterialien und Kleinteile von Kindern fernhalten!
- GB General safety instructions:**
Package material you do not need any more take far away from children.
- F Consigne de sécurité:**
Ecarter les matériaux d'emballage et petites pièces inutiles de la portée des enfants.
- PL Ogólne zasady bezpieczeństwa:**
Nie potrzebne opakowania i małe części chronić przed dziećmi!
- RU Общие указания по безопасности:**
Неиспользуемые упаковочные материалы и мелкие детали следует хранить в недоступном для детей месте!
- NL Algemene veiligheidsinstructie:**
Verpakkingsmaterialen die u niet meer nodig heeft en kleine onderdelen uit de buurt van kinderen houden!
- TR Genel güvenlik uyarısı:**
Kullanılmayan ambalaj malzemeleri ve küçük parçaları çocuklardan uzak tutun!
- RO Indicațiile generale de siguranță:**
Ambalajele care nu mai sunt necesare și piesele de mică dimensiuni nu vor fi lăsate la îndemâna copiilor!
- IT Indicazioni generali per la sicurezza:**
Tenere lontano da bambini materiali di imballaggio non più necessari e minuterie!
- SK Všeobecné bezpečnostné upozornenie:**
Nepotrebný baliaci materiál a malé diely uchovávať mimo dosahu detí!
- CZ Všeobecné bezpečnostní upozornění:**
Obalové materiály a malé díly, které už nepotřebujete, udržujte mimo dosah dětí!
- HU Általános biztonsági tudnivaló:**
Ha már nincs szüksége a csomagolóanyagokra és apró darabokra, tegye őket olyan helyre, ahol nem férhetnek hozzá gyermekek!

Ax2	Bx1	Cx2	Dx4	Ex4	Fx2	Gx2	Hx36 (M8x20)
Ix1	Jx8 (Ø10x50)	Kx1	Lx1	Mx2	Nx8 (Ø3,5x25)	Ox2 (M8x25)	

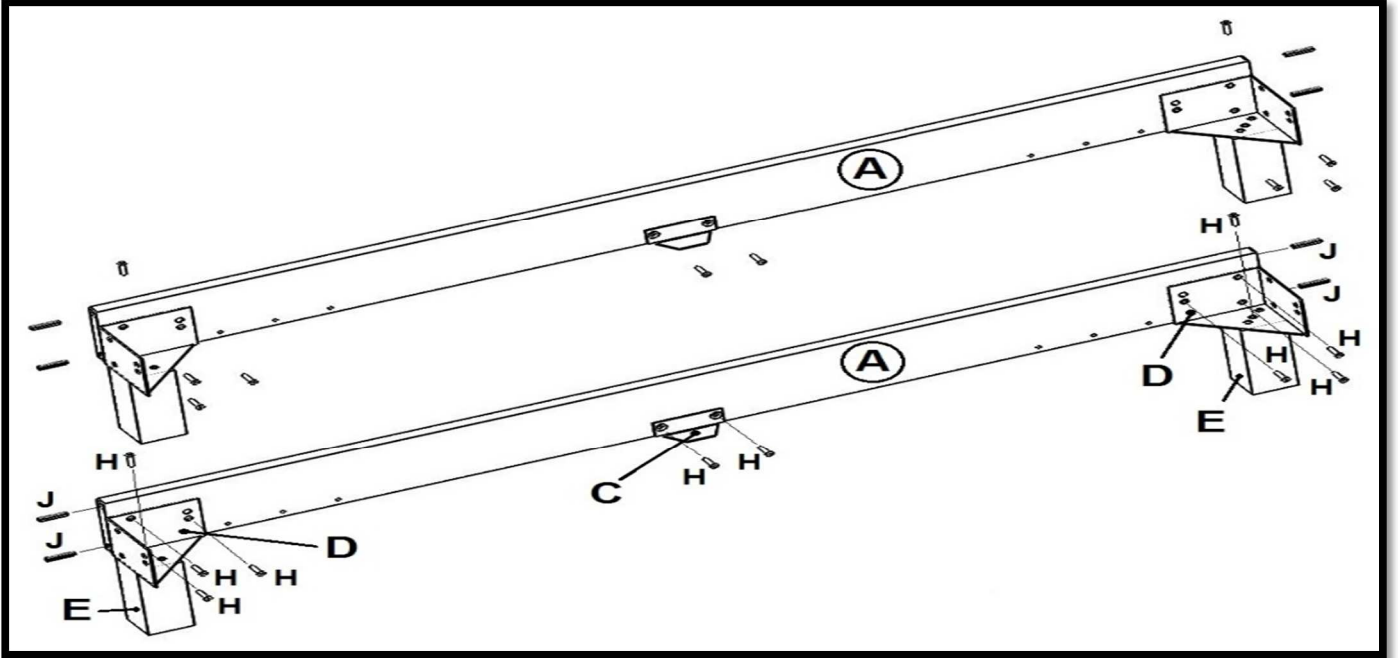
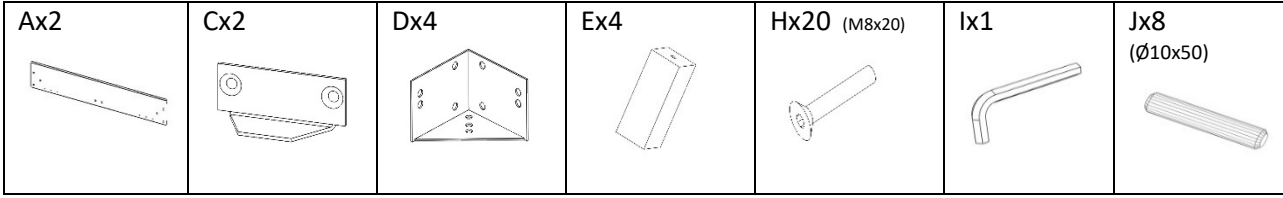

1.

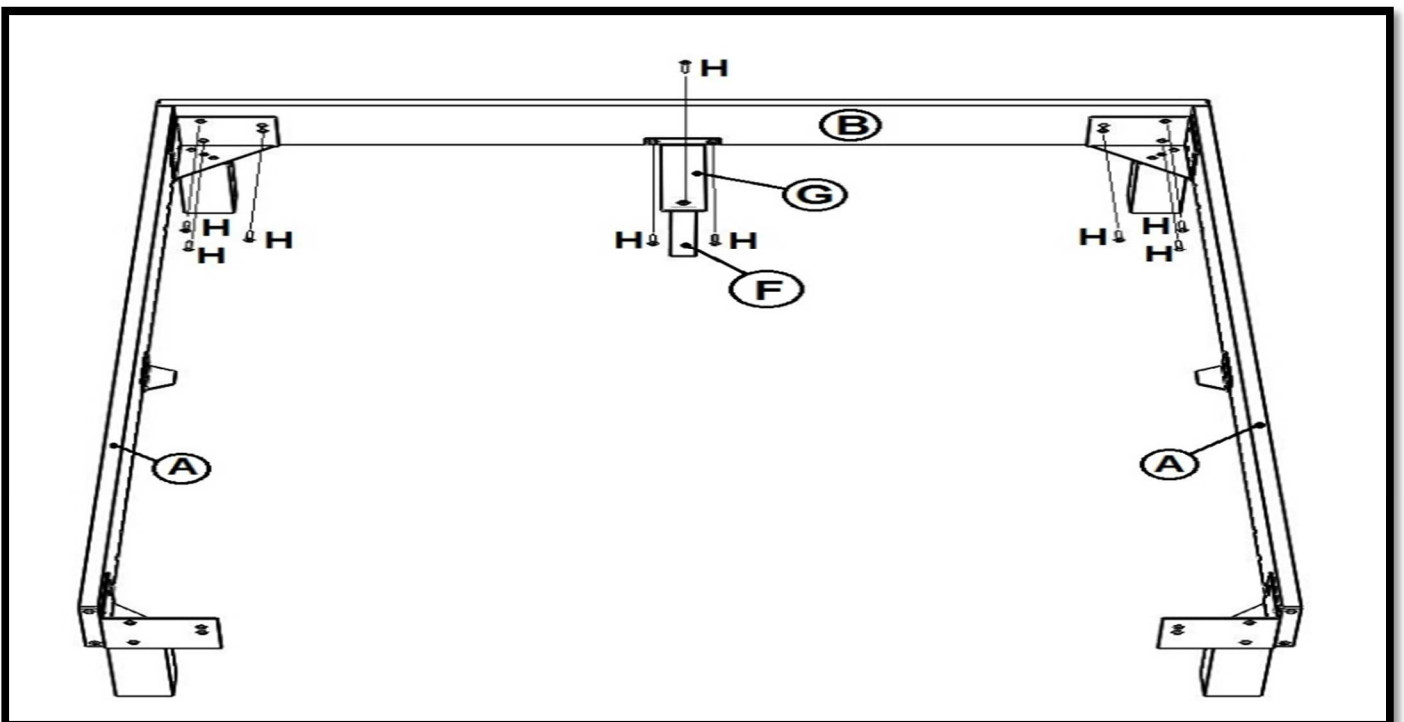
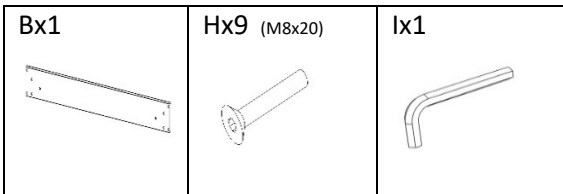

2.



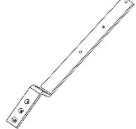



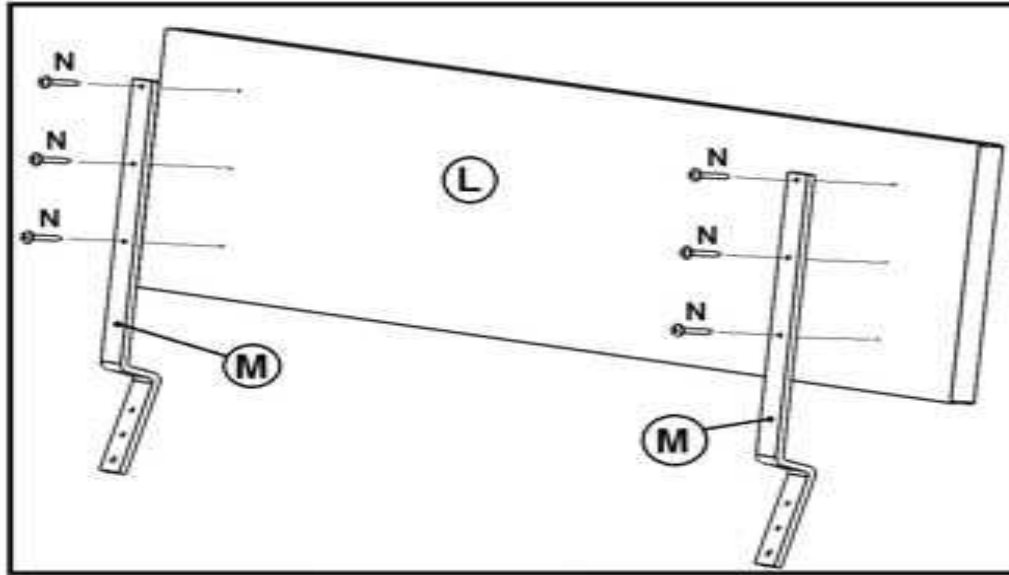

3.

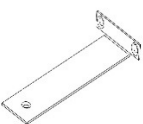
Lx1 	Mx2 	Nx6 (ø3,5x25) 
---	--	--



4.

Fx2 	Gx2 	Kx1 	Hx7 (M8x20) 	Nx2 (ø3,5x25) 	Ox2 (M8x25) 	Ix1 
--	--	--	--	--	--	--

