

980729

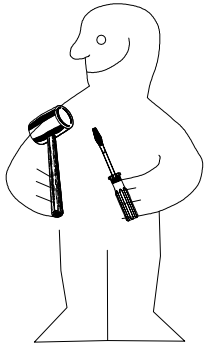

1.

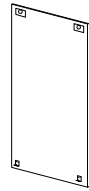

2.

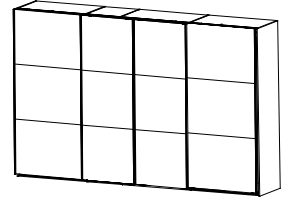
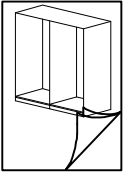
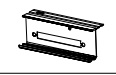
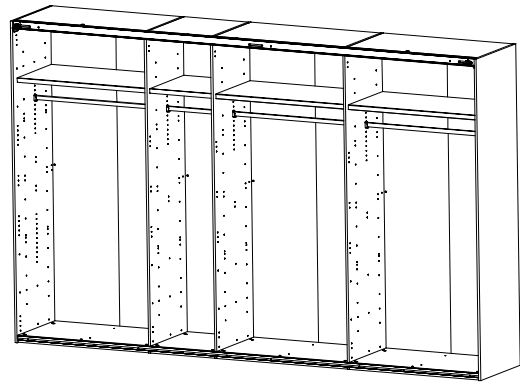
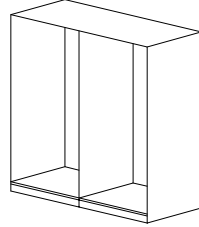

MR HSP 350 4trg

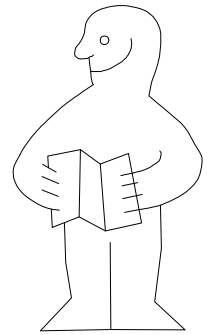
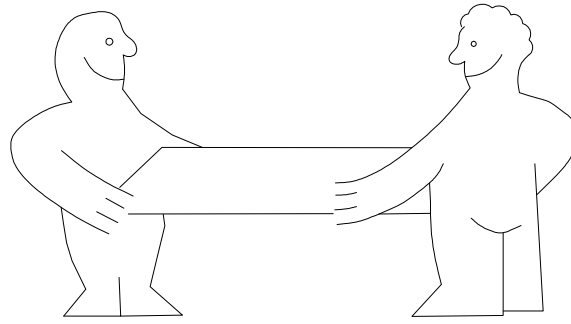
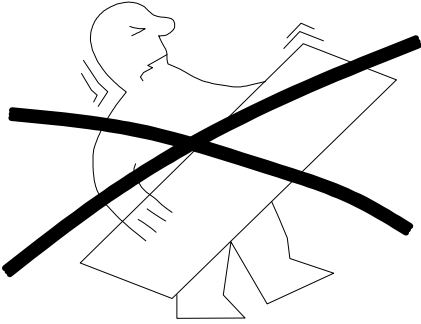

1-2-3-4... ○

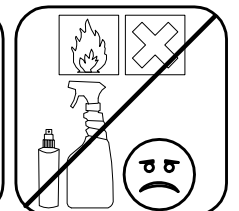
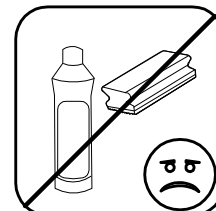
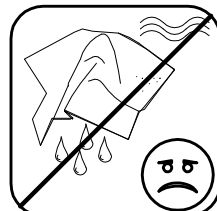
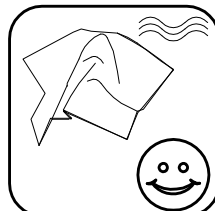
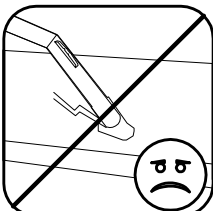
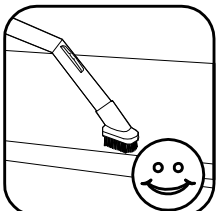
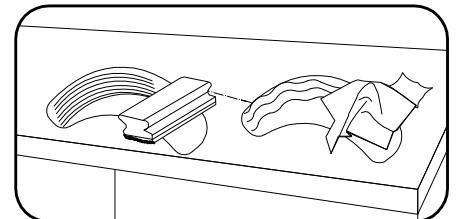
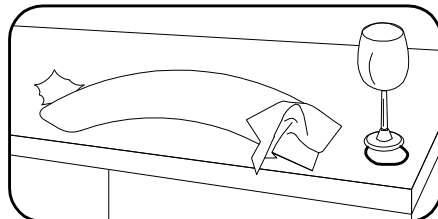
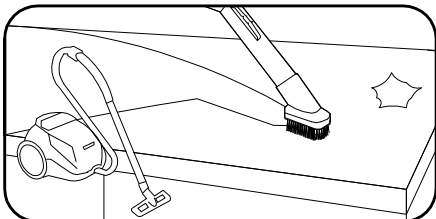
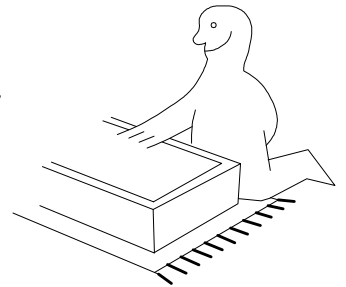
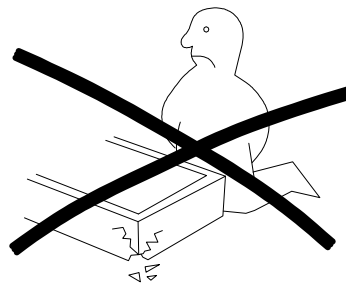
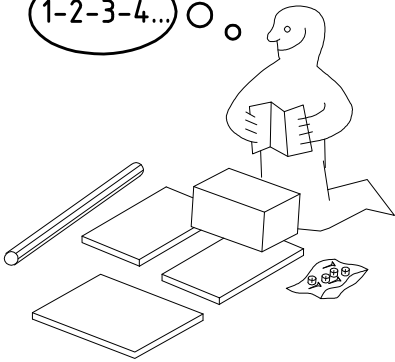





980729

03.01.17 / -

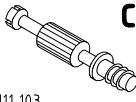

01 17

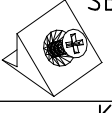
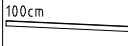

1/12

 111 xxx	A1 32x
 111 103	C 8x
	F3 12x

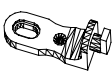
 111 xxx	S0 19x
 111 xxx ø12	V12 19x
 121 370 3,5 x 15 mm	G1 54x

 117 002	K2 8x
	SBV 28x
 100cm 112 400	K10 3x

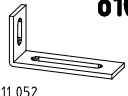

 111 611	J2 11x
 6,3 x 10,5 mm 112 055	T1 46x
 111 607	L8 16x

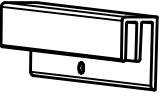

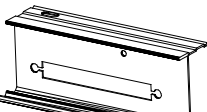
 111 052	o10 1x
 4 x 15mm 121 120	SP15 4x
 50cm 112 401	K11 1x

1x 
FPK
1453/1940/2430/2920/3408

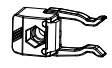
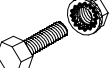
1x 
SWT-LP
1453/1940/2430/2920
/3410 SY

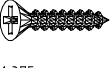

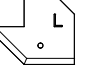
 121 xxx	SWT-ST 2x
 121 xxx M4 x 13 mm	SWT-SM5 2x
 121 xxx M4 x 10 mm	GH13 8x
 121 xxx M4 x 10 mm	G43 8x
 121 375 3,5 x 35 mm	G14 2x

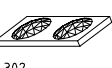
 121 004	SWH-SKL 1x
 121 004 3,5 x 22 mm	SWH-SKR 1x
 121 004	G24 10x
 352 302	KP8 4x

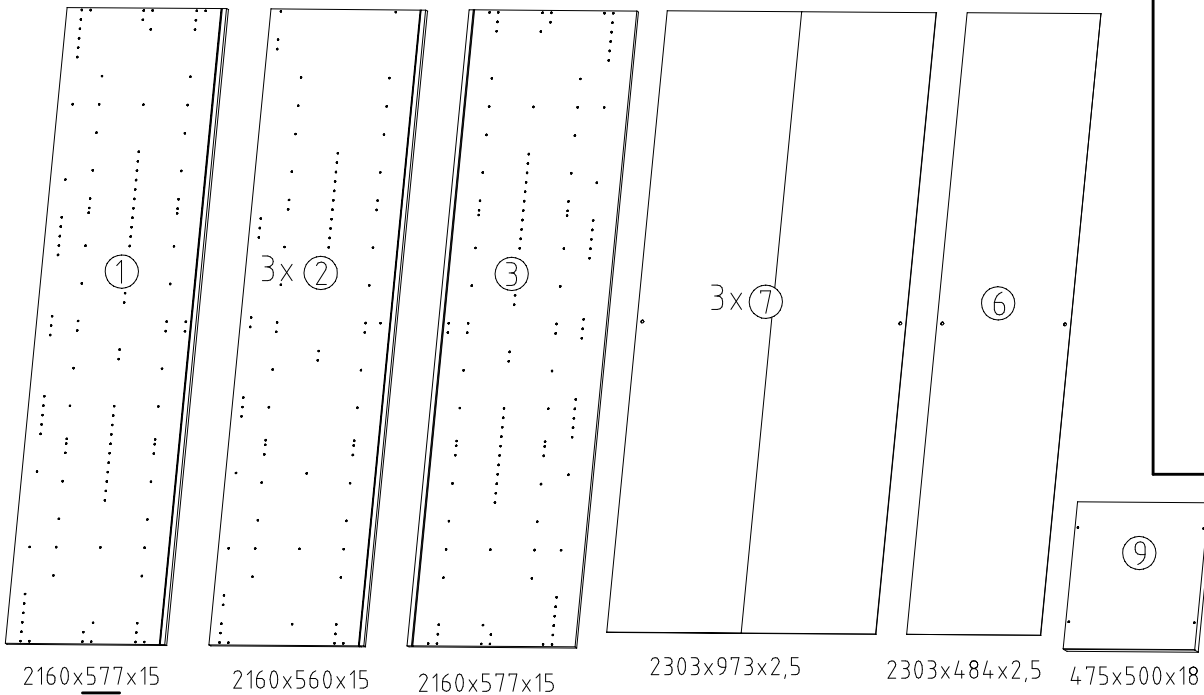
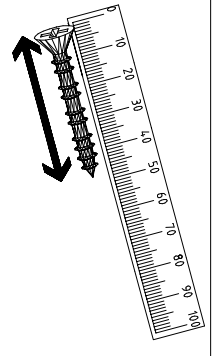
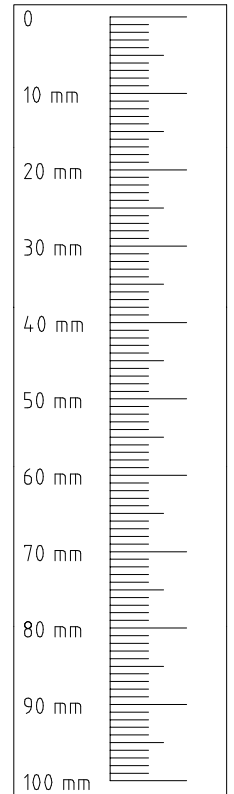
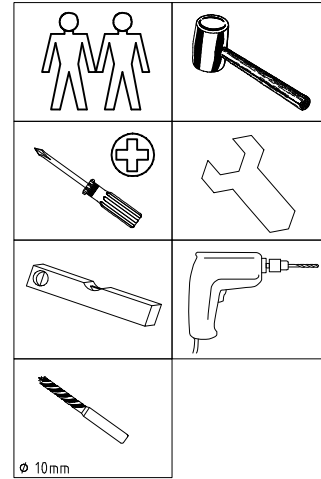

1

3,5 x 15 mm

G1



121 370

S0

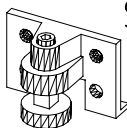

111 xxx

A1

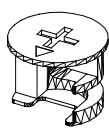

111 xxx

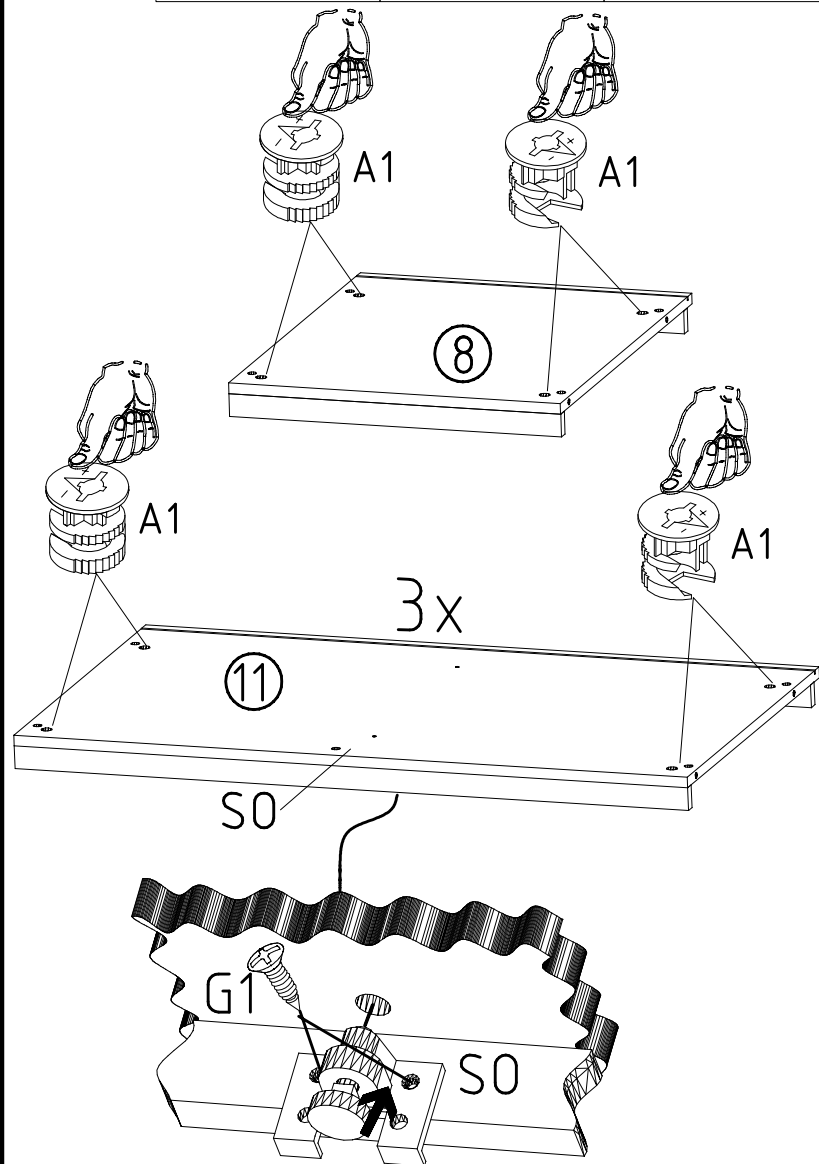

2

A1



111 xxx

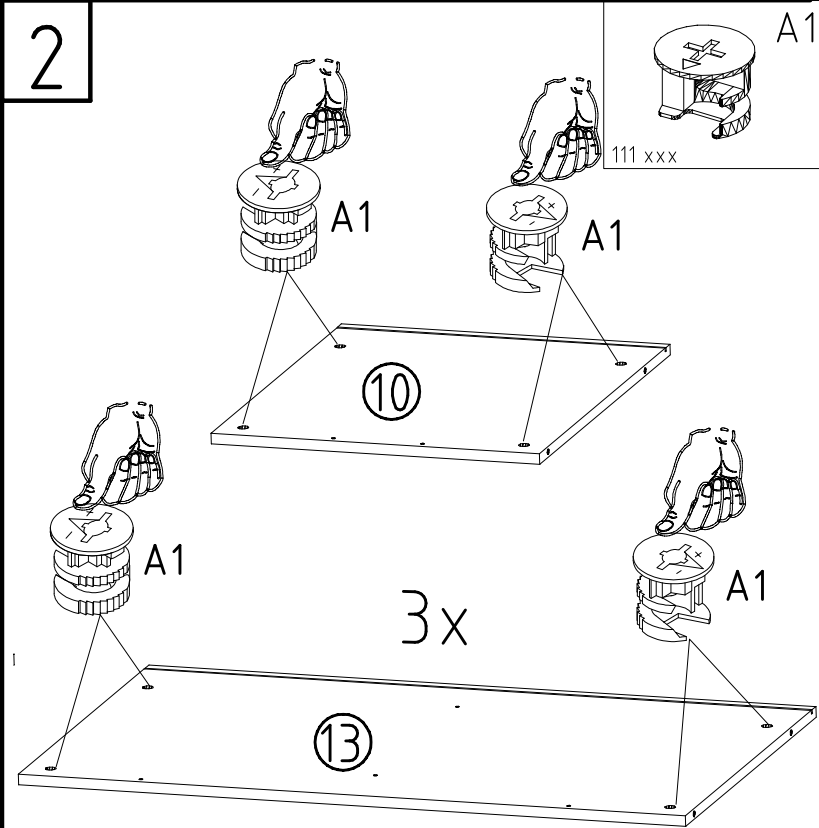

3



F3

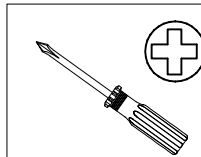
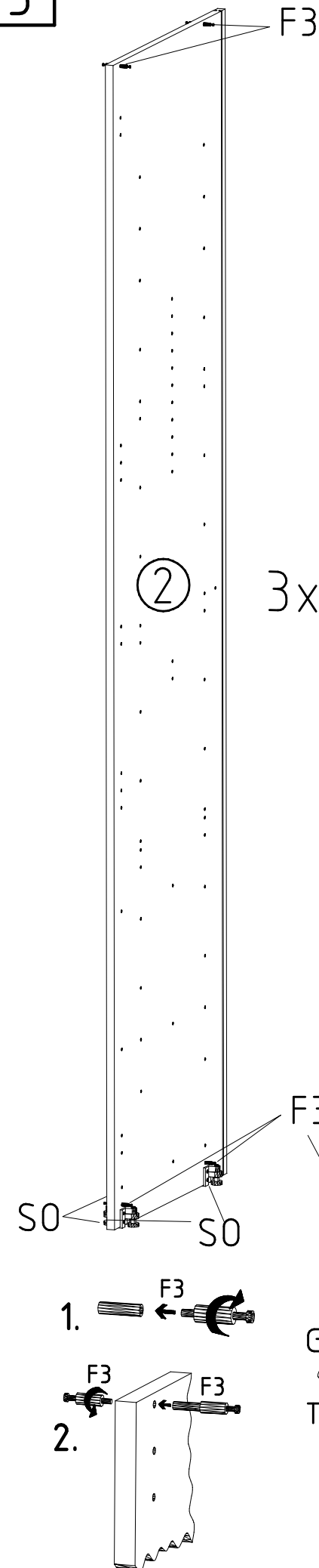

6,3 x 10,5 mm



T1

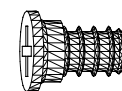

112 055

3,5 x 15 mm

G1

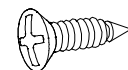

121 370

S0

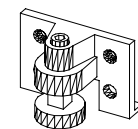

111 xxx

F3

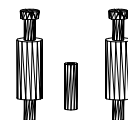

4

SWH-SKL

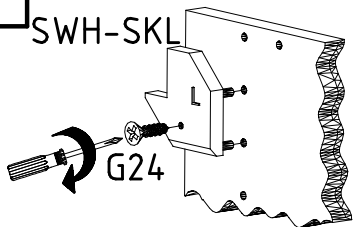

SWH-SKR

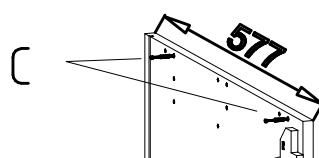
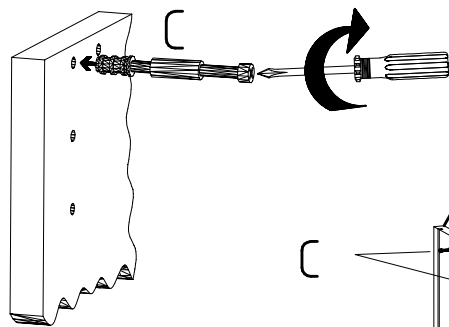
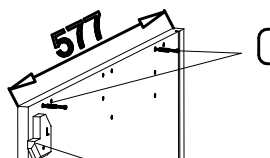
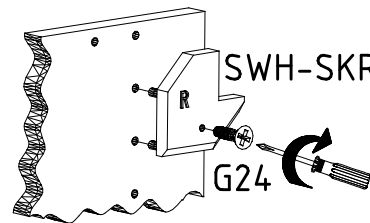

SWH-SKL + G24

SWH-SKR + G24

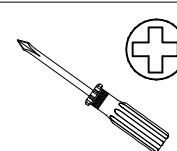

SWH-SKL

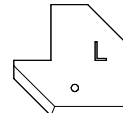

SWH-SKR

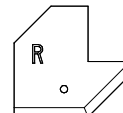

3,5 x 22 mm G24



121 004

6,3 x 10,5 mm T1

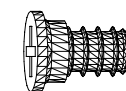

112 055

3,5 x 15 mm G1

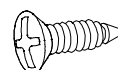

121 370

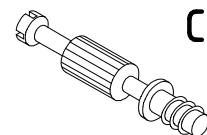

111 103

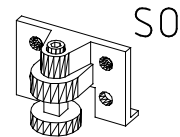

111 xxx

1

3

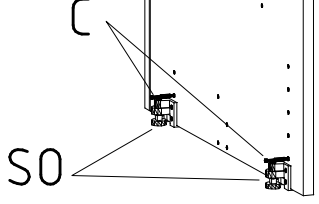
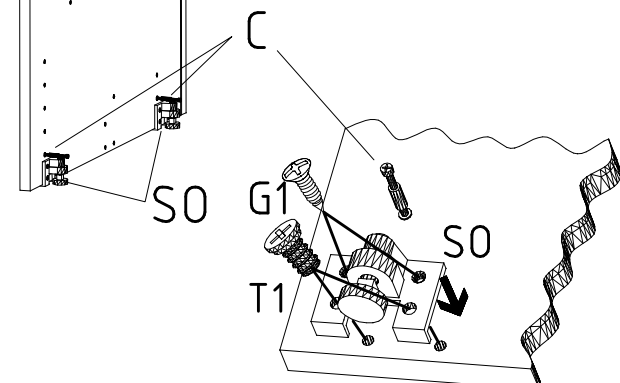

5

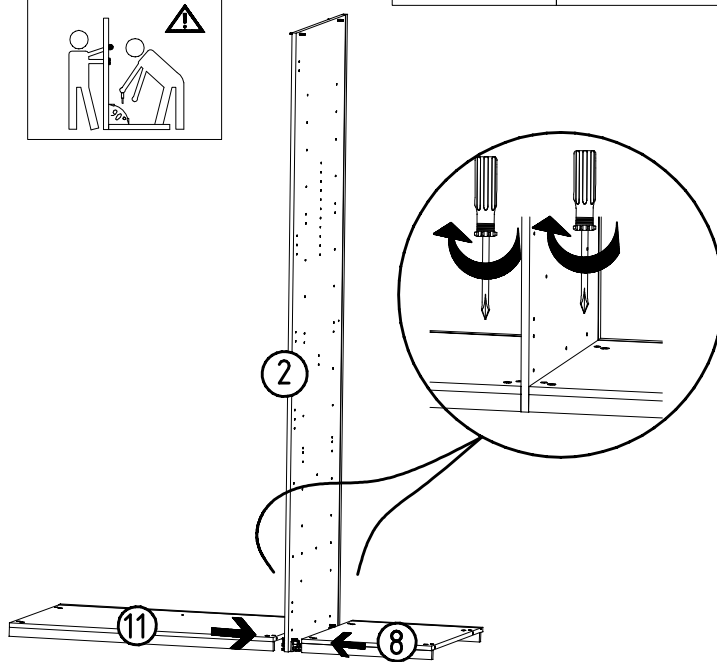
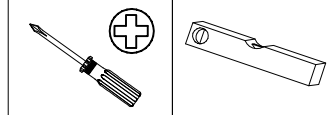

6

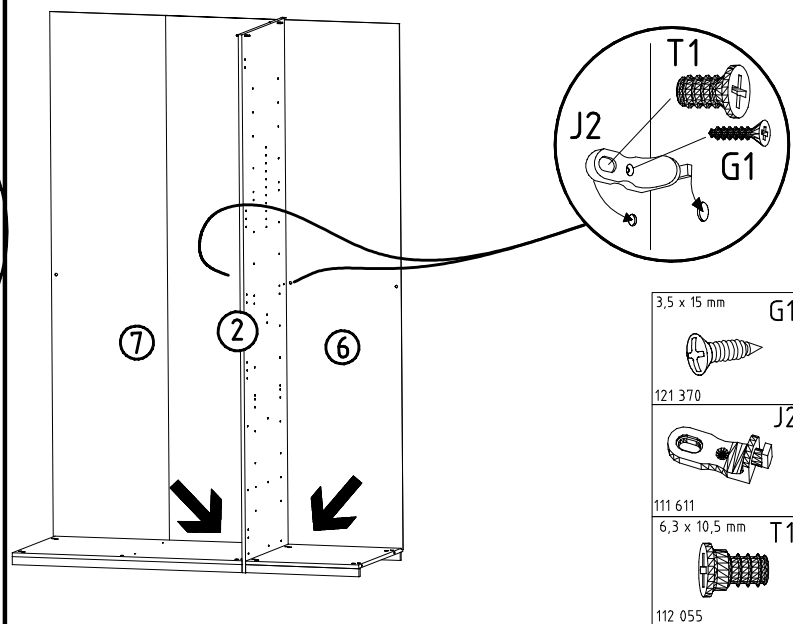
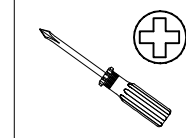

7

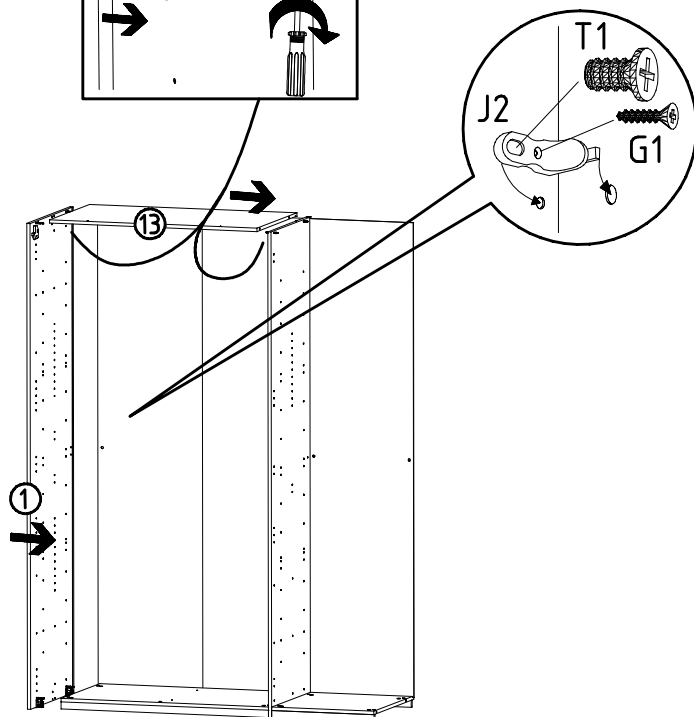
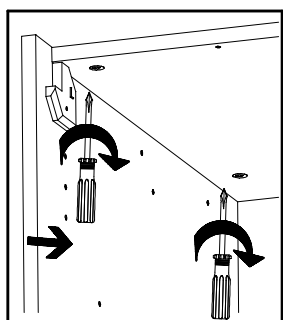
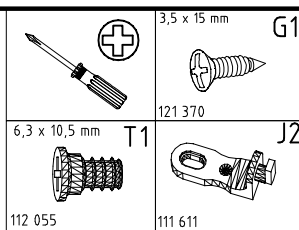

8

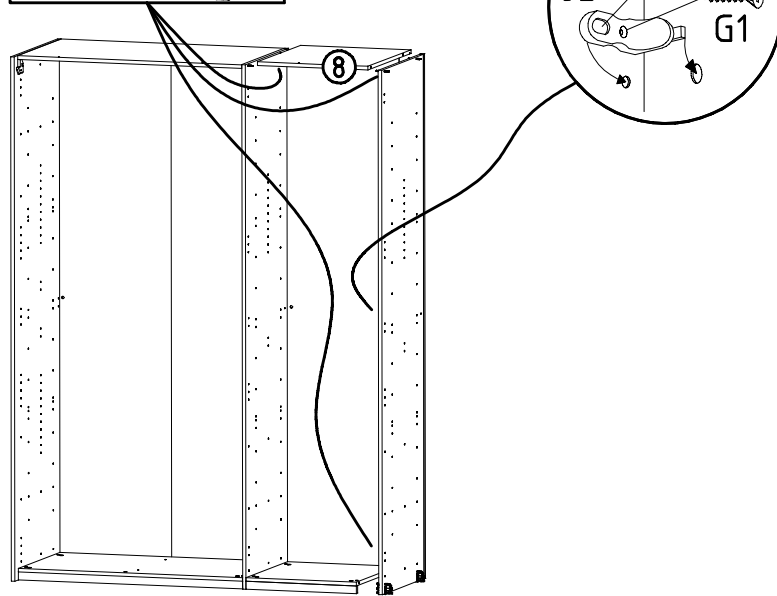
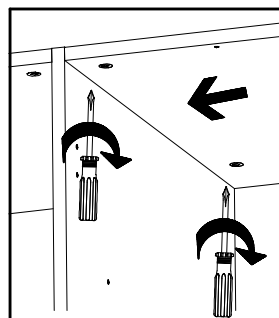
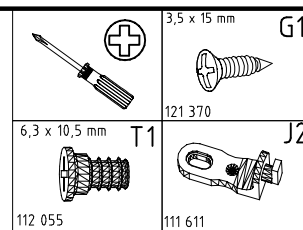

9

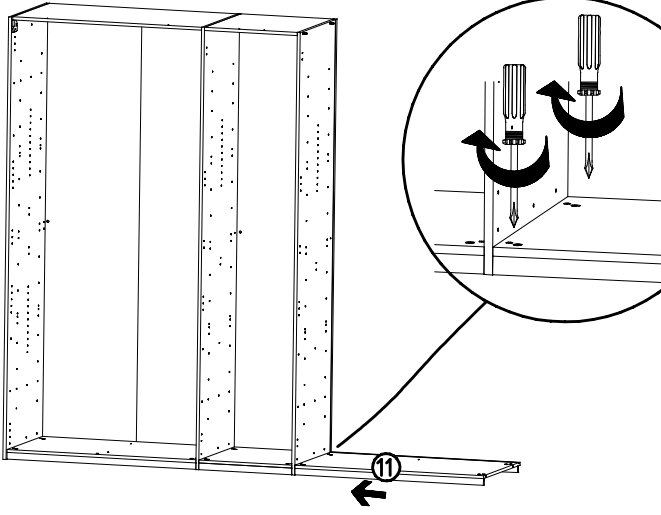
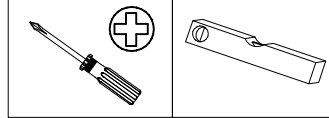

10

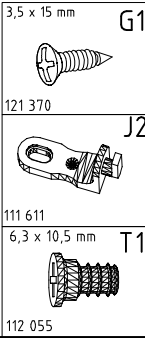
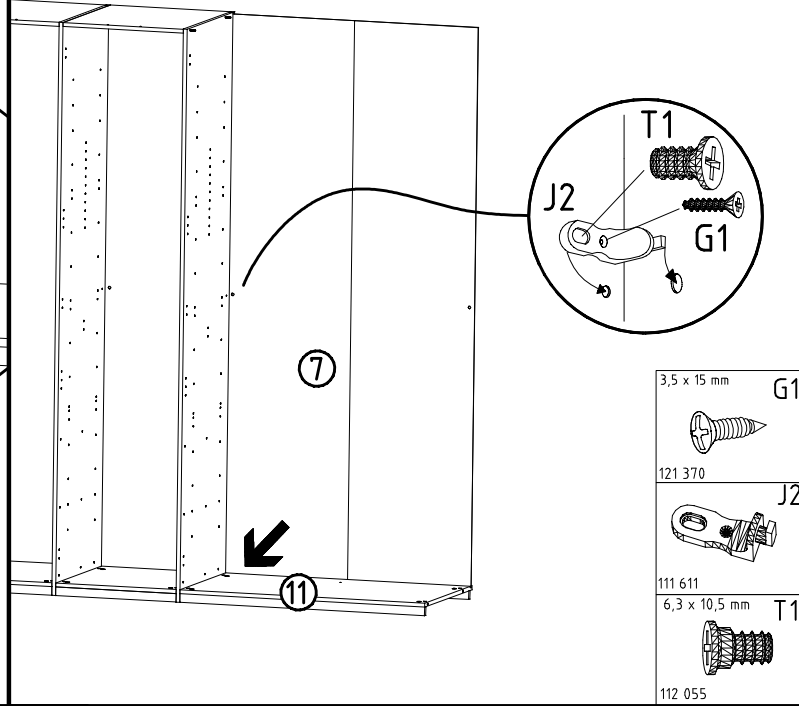
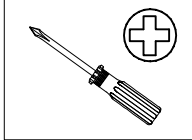

11

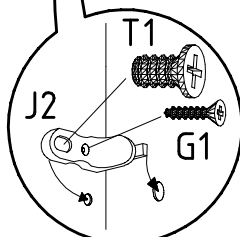
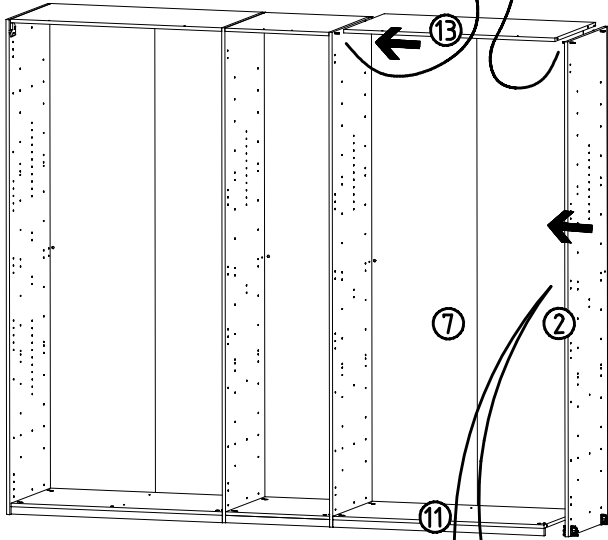
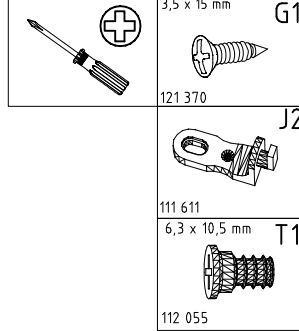
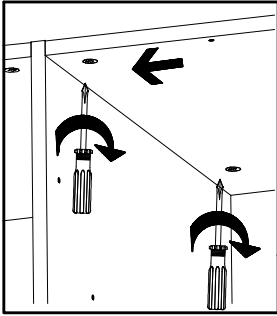

12

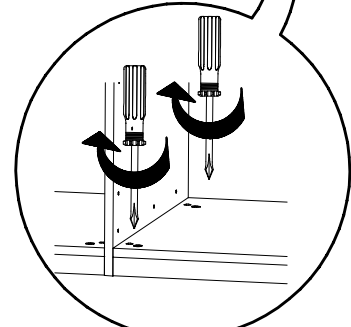
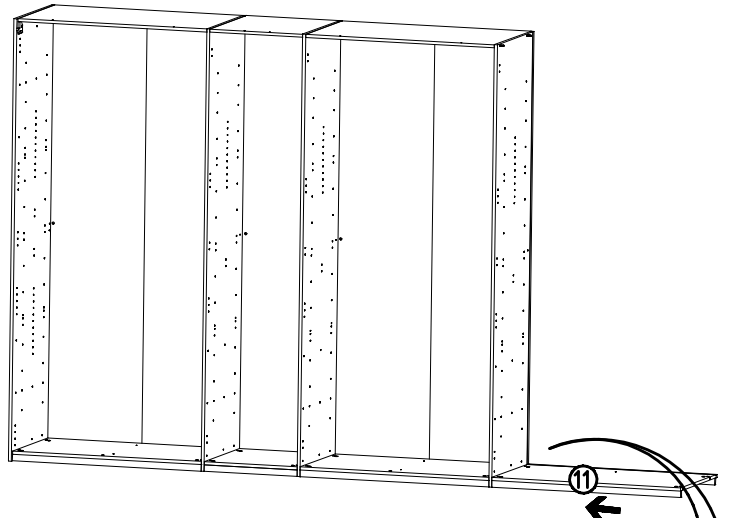
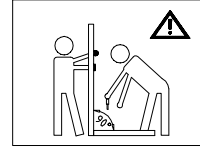
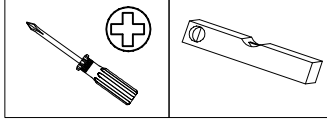

980729

03.01.17 / -

01 17

6/12

13

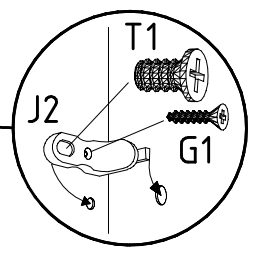
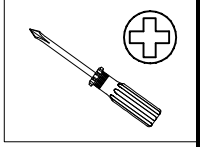
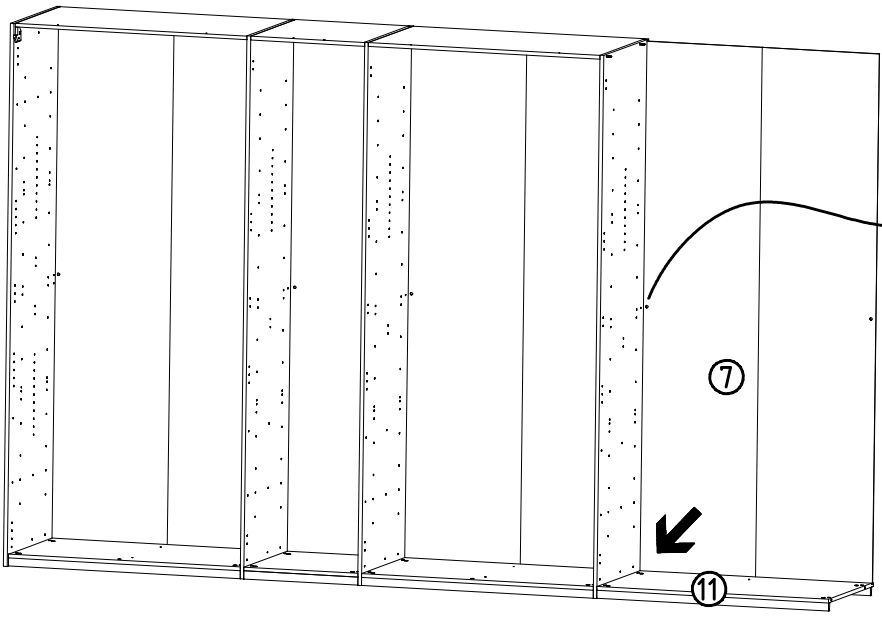

- 3,5 x 15 mm G1
- 121 370
- 111 611
- 6,3 x 10,5 mm T1
- 112 055

14

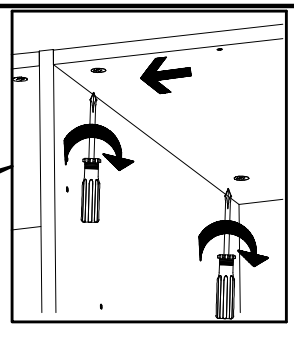
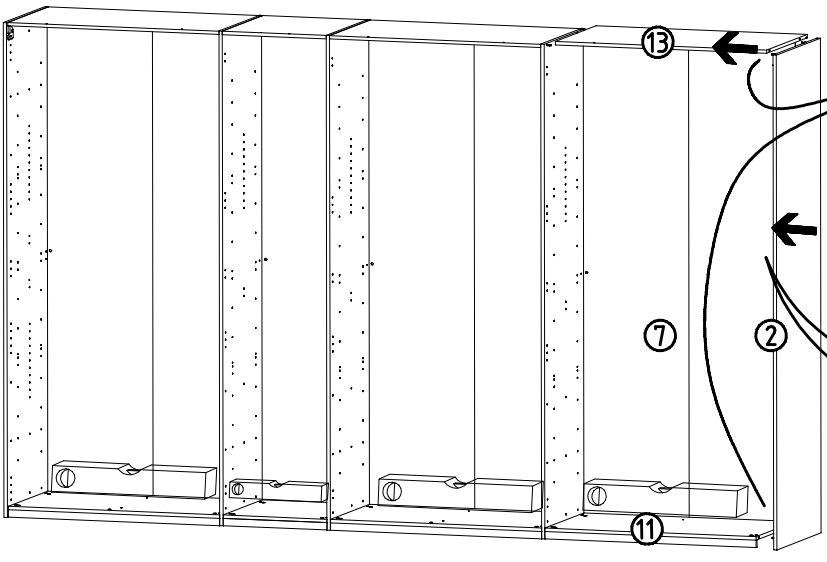

- 3,5 x 15 mm G1
- 121 370
- 111 611
- 6,3 x 10,5 mm T1
- 112 055

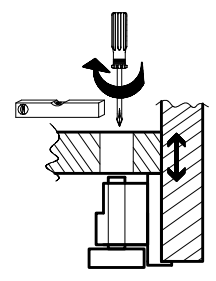

15

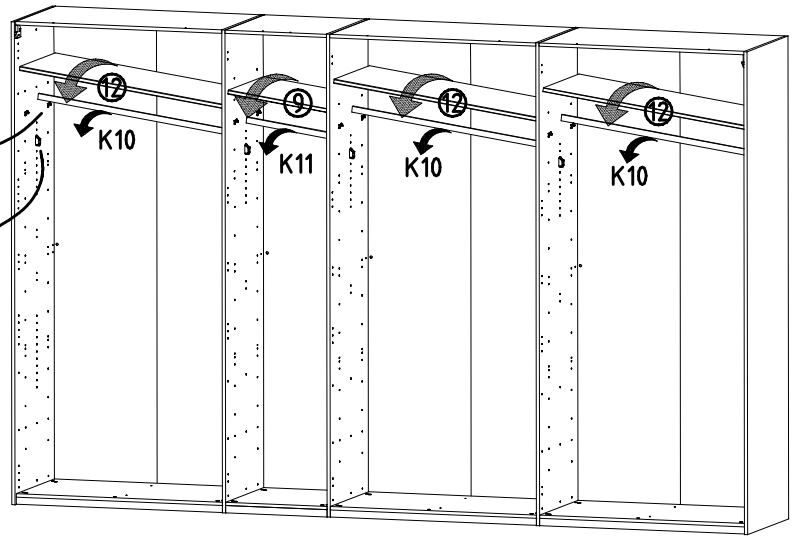
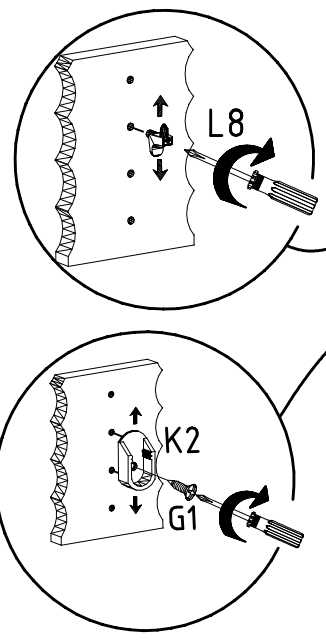

- L8
- 111 607
- K2
- 117 002
- 3,5 x 15 mm G1
- 121 370
- K10
- 100cm
- 112 400
- K11
- 50cm
- 112 401

16

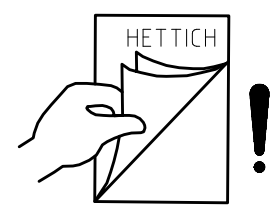
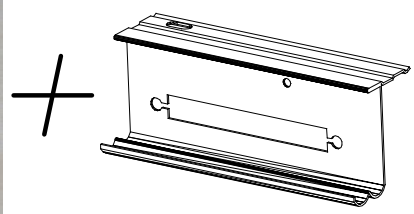
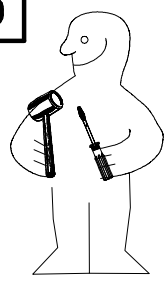

17

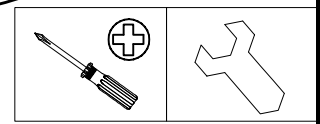
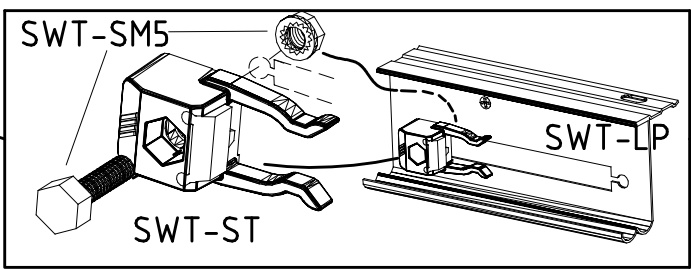
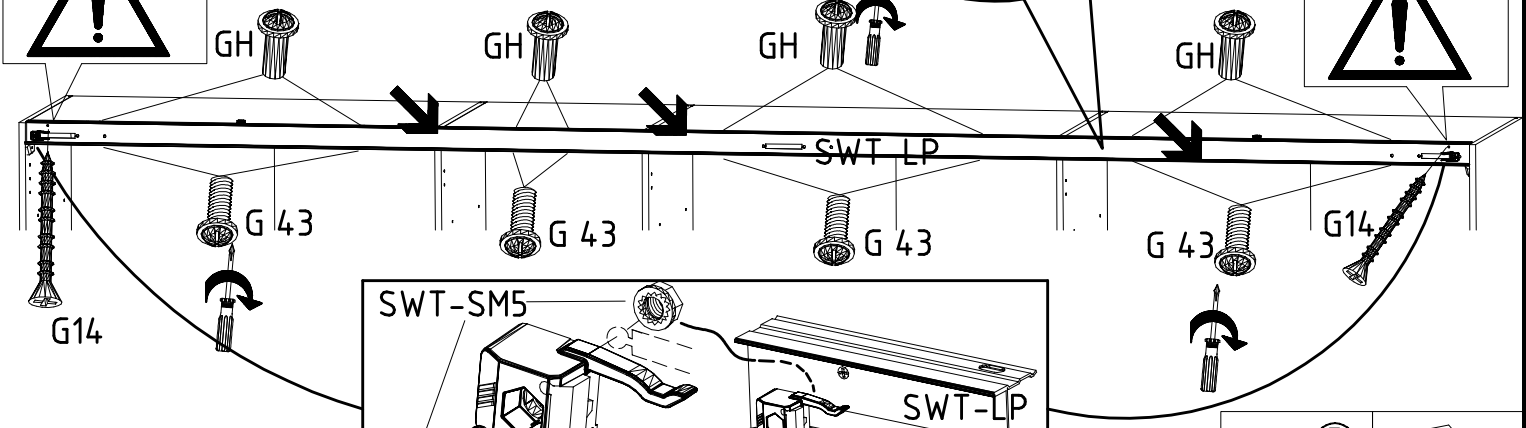
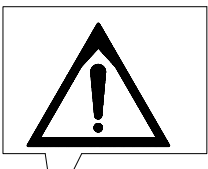
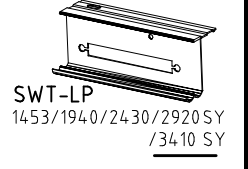
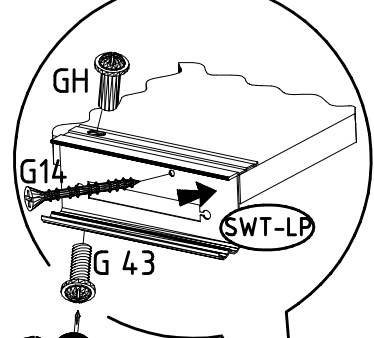
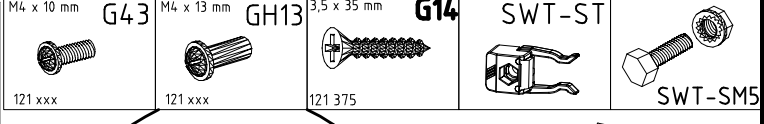
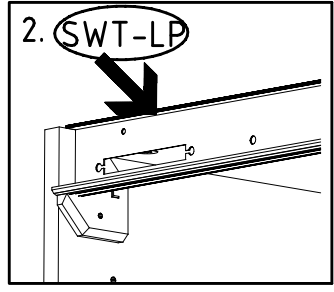
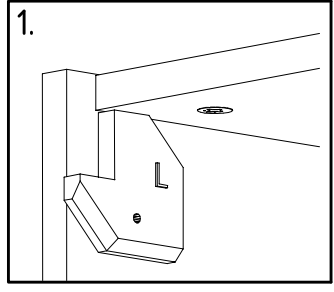

18

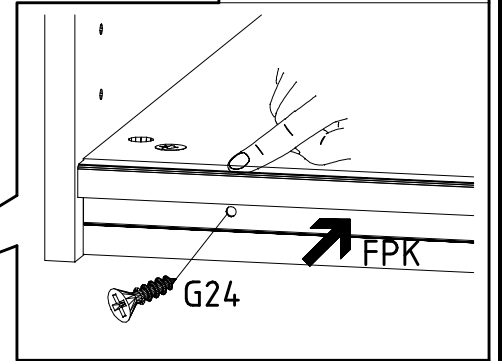
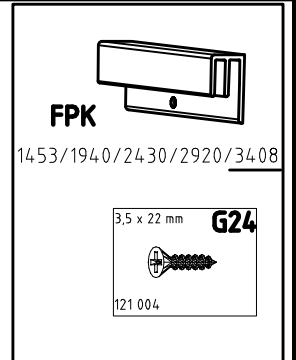
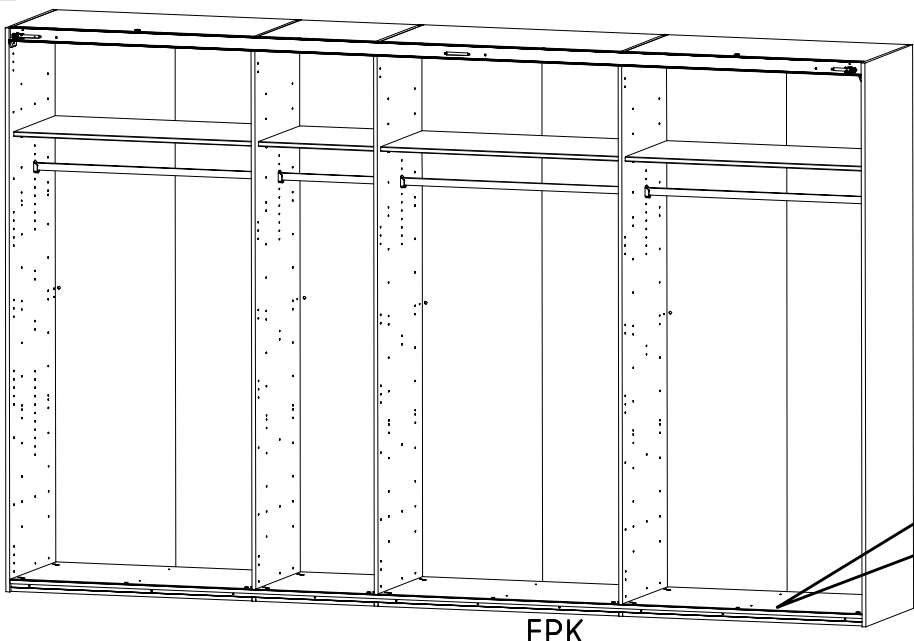

19

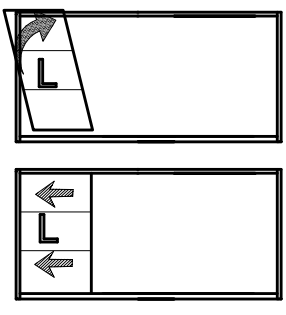

20

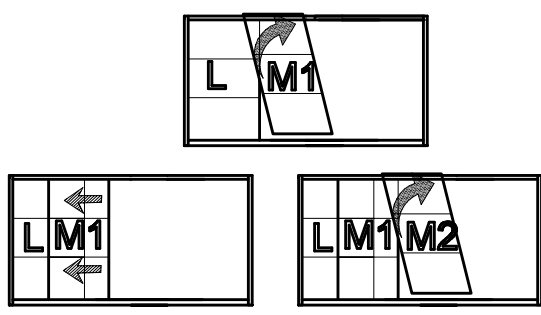

21

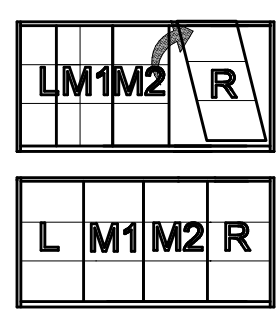

19 + 21

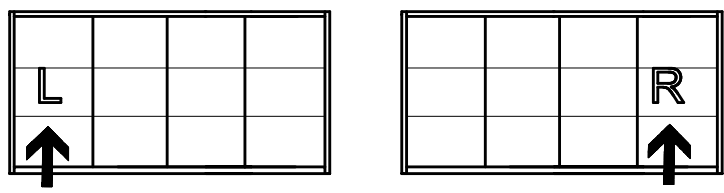

20

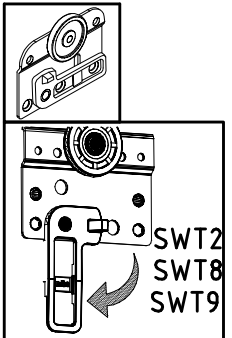
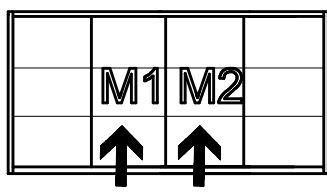

I.

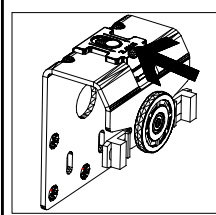
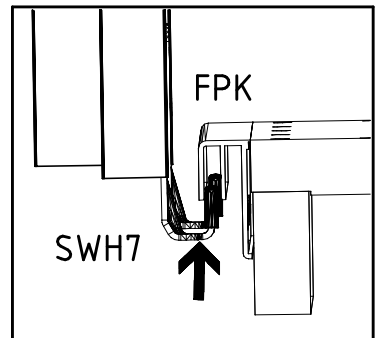

I.

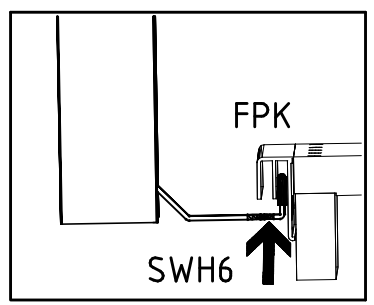

II.

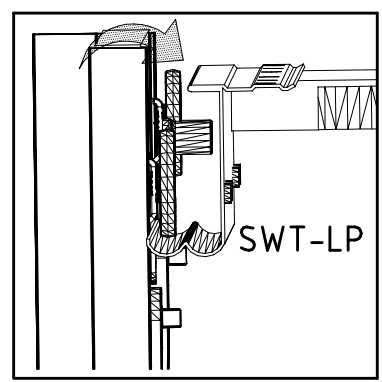

II.

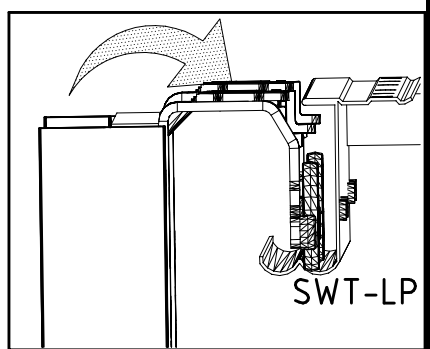

III.

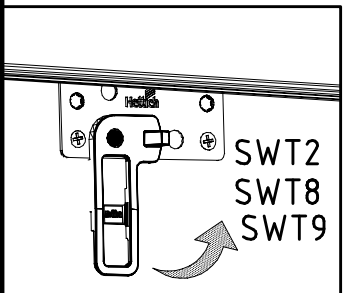

III.

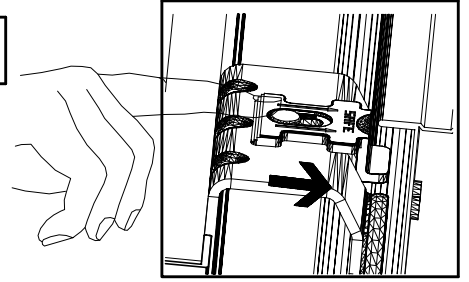
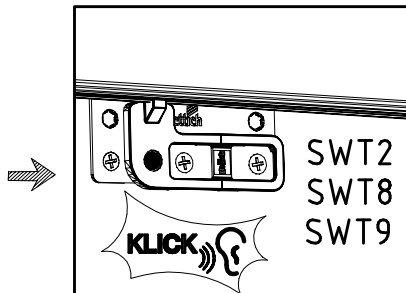

22

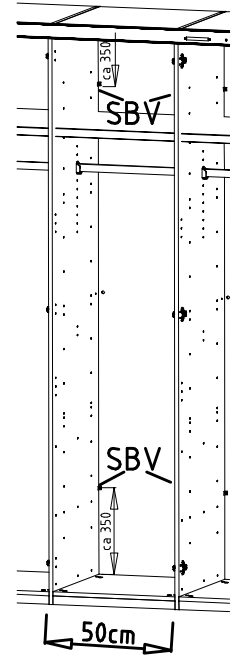
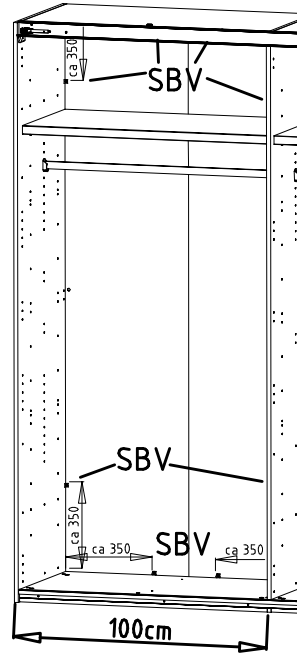
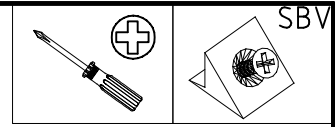
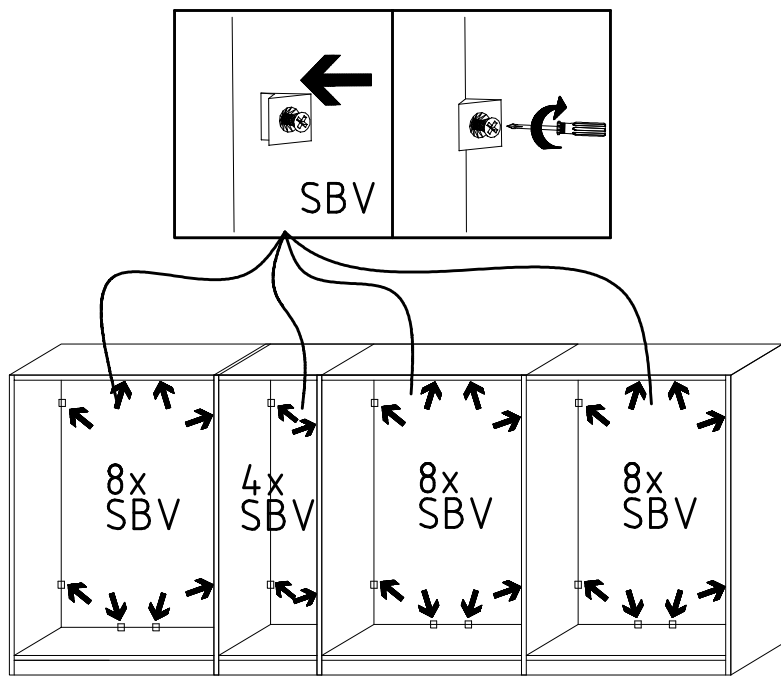

23

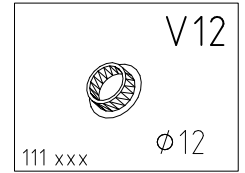
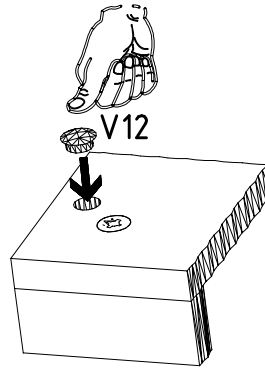
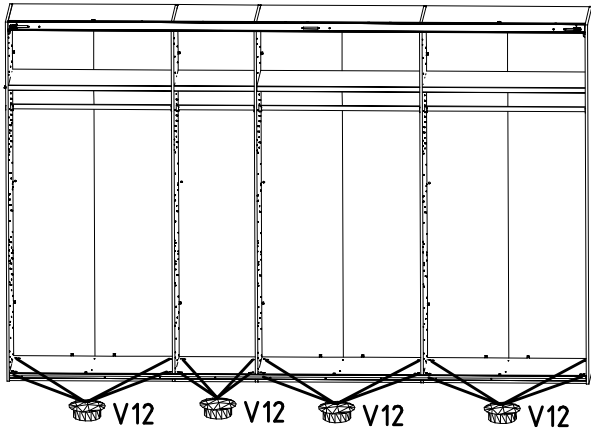

24

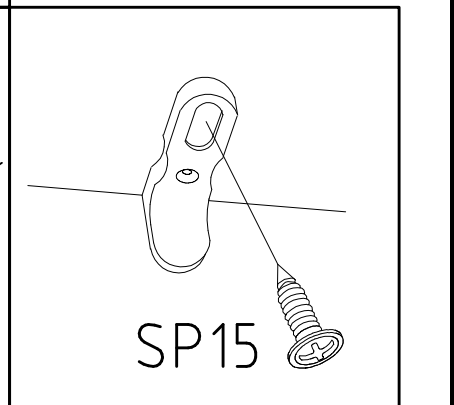
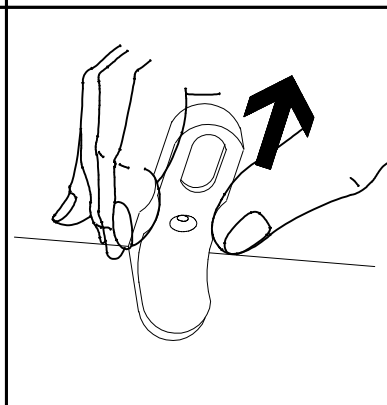
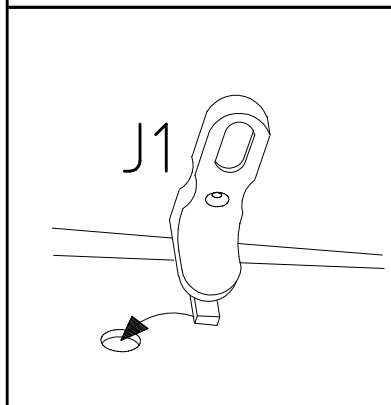
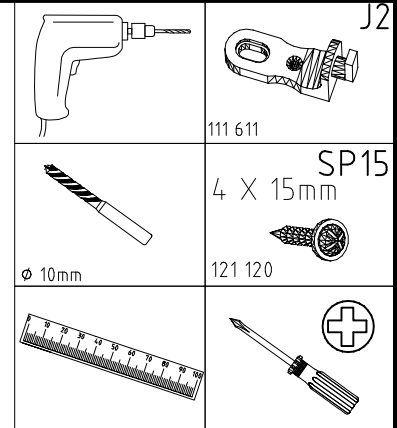
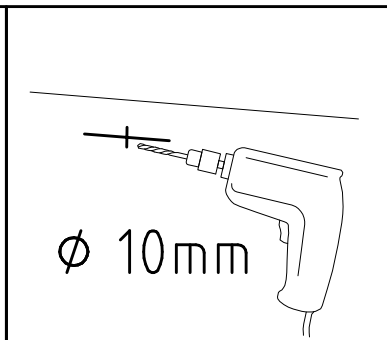
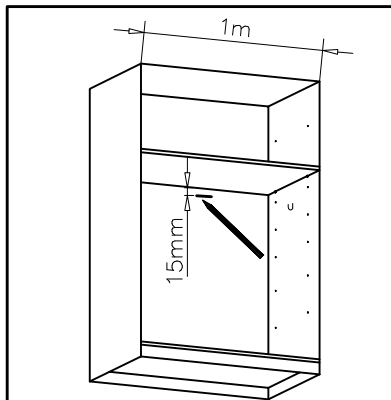

25

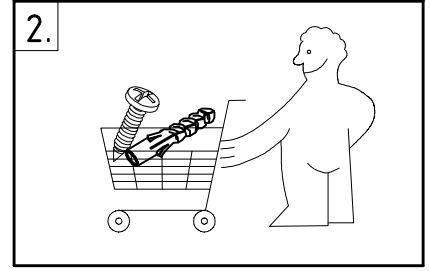
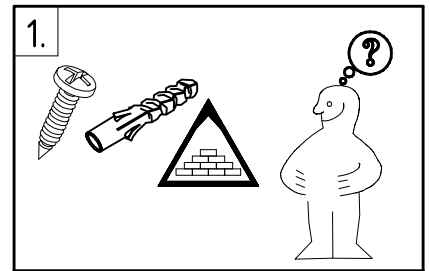
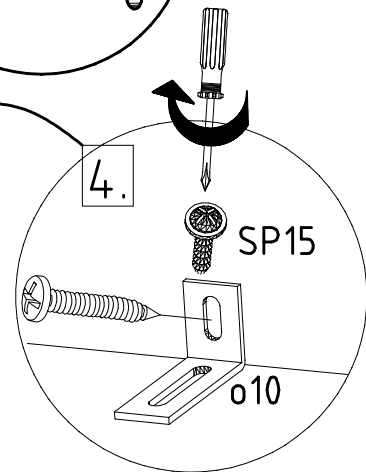
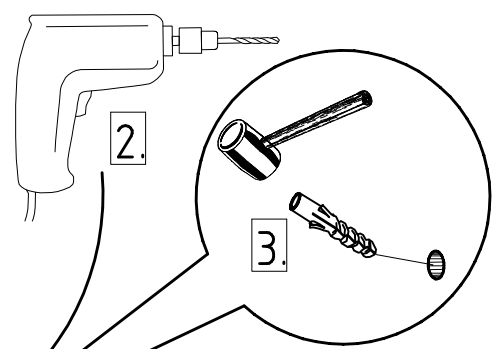
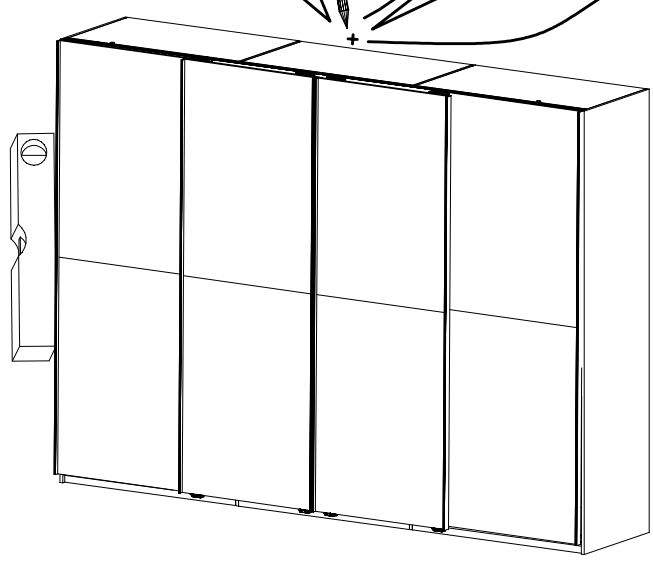
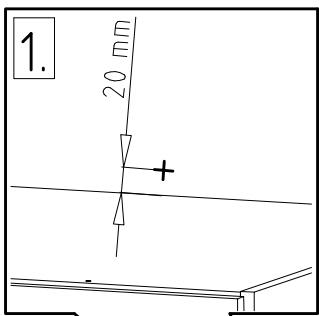
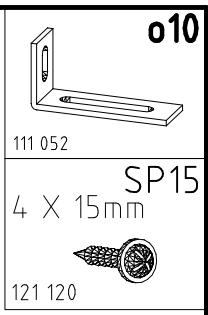
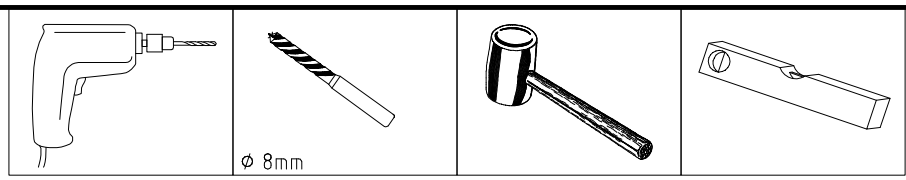

26

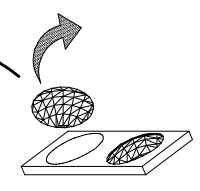
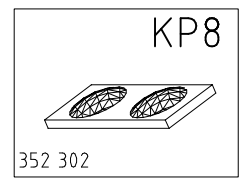
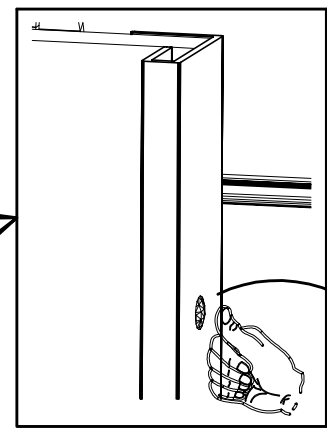
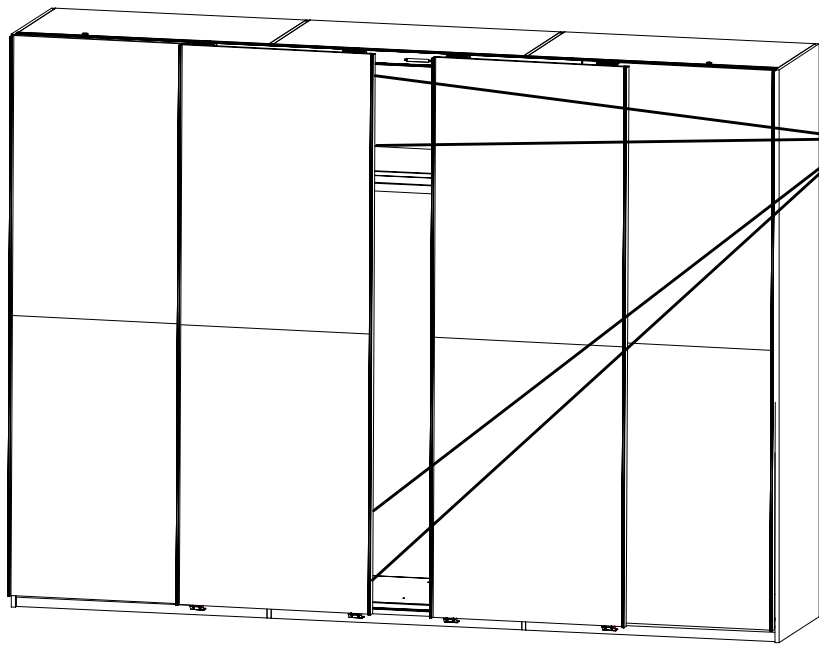

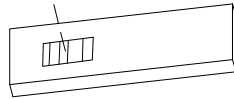
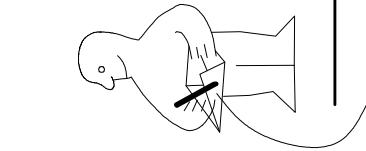
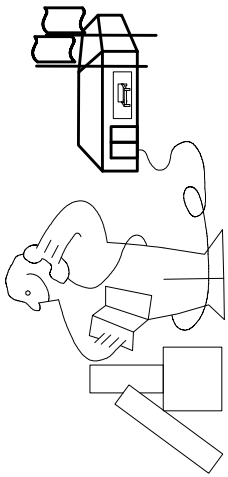
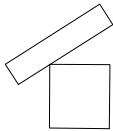
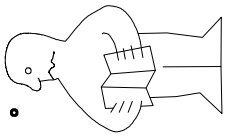

Modell/Model/Modèle



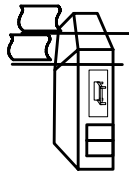

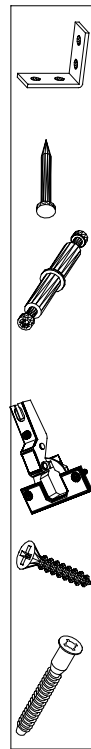

{121 370}	{ G 1 }	{4x}

Änderungen die dem technischen Fortschritt geschuldet sind, behalten wir uns vor !

Bei nicht vorschriftsmäßiger und/ oder nicht fachmännischer Montage wird bei Personen- und/ oder Sachschäden keinerlei Haftung übernommen.

WIMEX Wohnbedarf/ Import Export Handels GmbH/ Postfach 1407/ 49112 Georgsmarienhütte/ Germany
Tel.:(+49) 05401 8598 72 Fax.:(+49) 05401 8598 33 Mail: service_H@wimex-online.com

104P-Nr. / 104P-No. 150X-Nr. / 150X-No. Auftrag/Order-No. / No. de Commande

23203 **30110XY** 104

Kunde MAX MUSTERMANN
Customer
Client

Kommission / your order reference / votre reference

3377 MINDEN

Dekor / Decor Decor / Modell / Modele

F99 **SAMPLE**

F99842 SCHWEBETUERENSCHRANK 250 CM H 216CM
PLANKENEICHE NB + RAU STEEL
PLANKENEICHE NACHBILDUNG

202320301107241476000001

Paket / Package / Paquet

414760

SOCKEL

Paket 1 von 8 Colli Kommission 10

HSP-SMT BOD 50 TEXT/TEX SOCKEL 32 FRESH TV / LF 104
SO-BOD TEXT RASTEX/ ZNBOD D18MM TX KLSTA

Montage - Anleitung Laenge 520,0 OBEREN
KS-64 Breite 568,0 OBEREN

SOCKEL32 KLEB

En cas de dommage, veuillez retourner le carton avec le produit. En cas de dommage, veuillez retourner le carton avec le produit.



OBEREN 5 30/19 HAUT 23.08.19 OBEREN 1 1. ABOVE OBEREN



WIMEX Wohnbedarf
Import Export Handelsges mbH & Co. KG
Werner-von-Siemens-Str. 35
D-49124 Georgsmarienhütte - Germany

SAMPLE **23.08.19**
Modellname Produktionsdatum
Model Date of manufacture

