

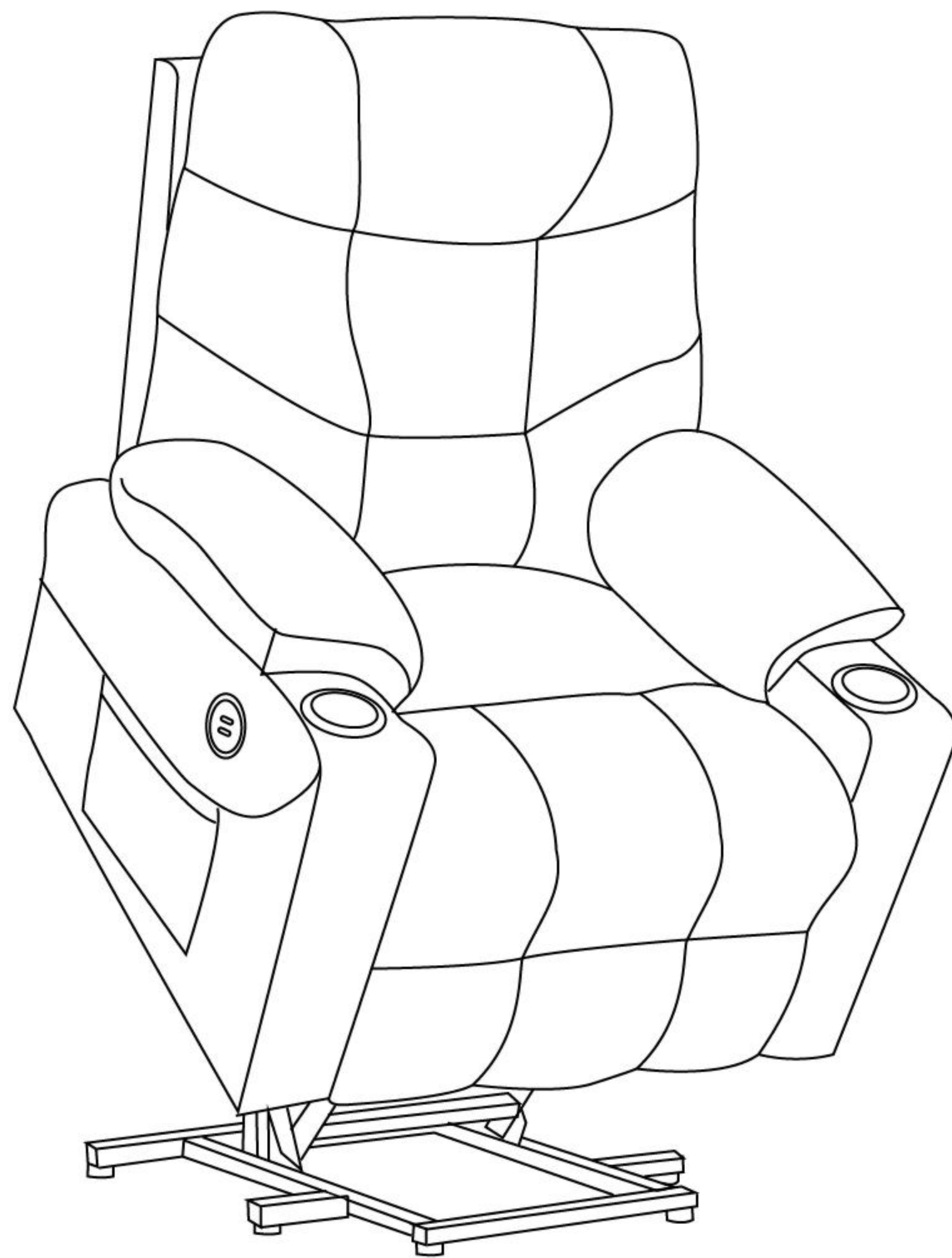

MCombo

Sofa assembly instruction





(English / Deutsch / Français / Español / Italiano)

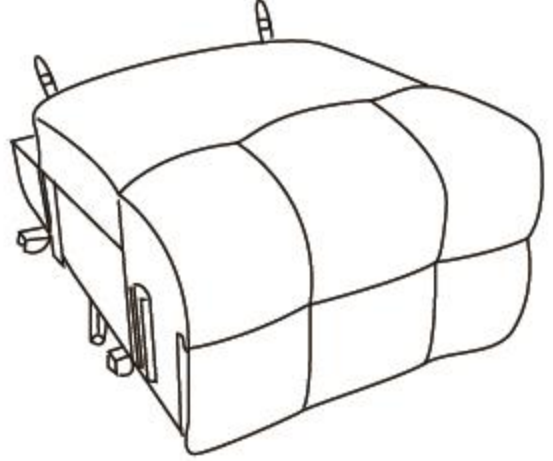
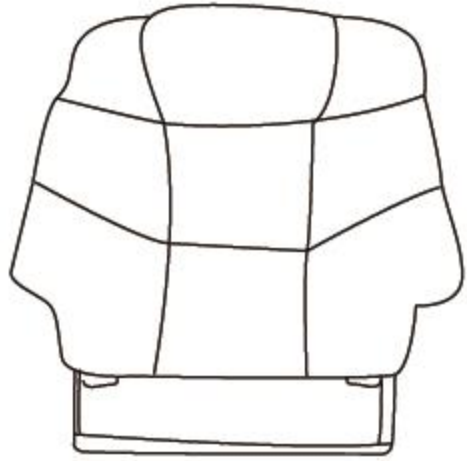
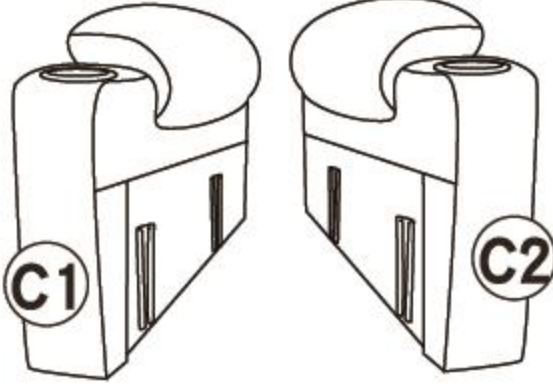
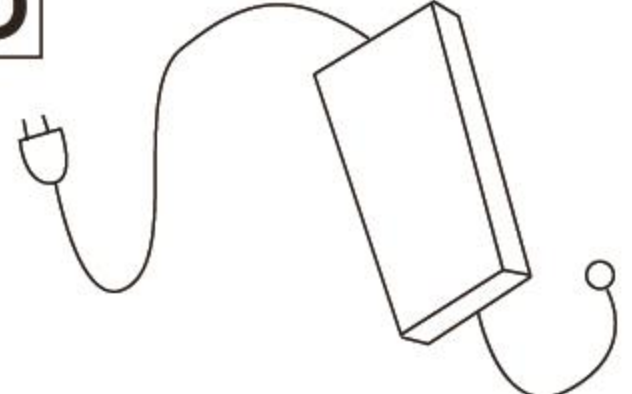

Pfillo GmbH

6160-7286/88

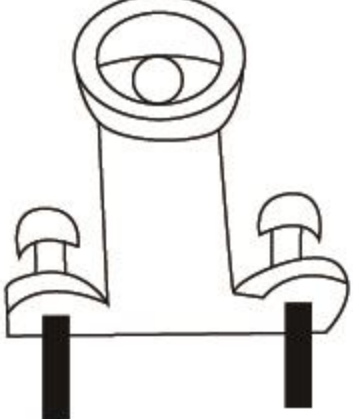
Sofa assembly instruction

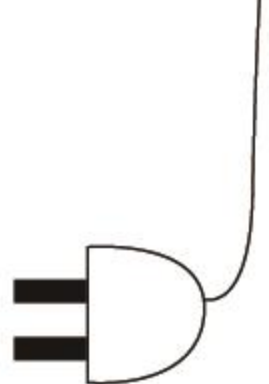
A  Chair base 1x	B  Backrest 1x	C  Left and right armrest 2x	D  Power cord 1x
E  Remote control 1x	F  Part1 2x	G  Part2 4x	H  Power connector 1x

Step1

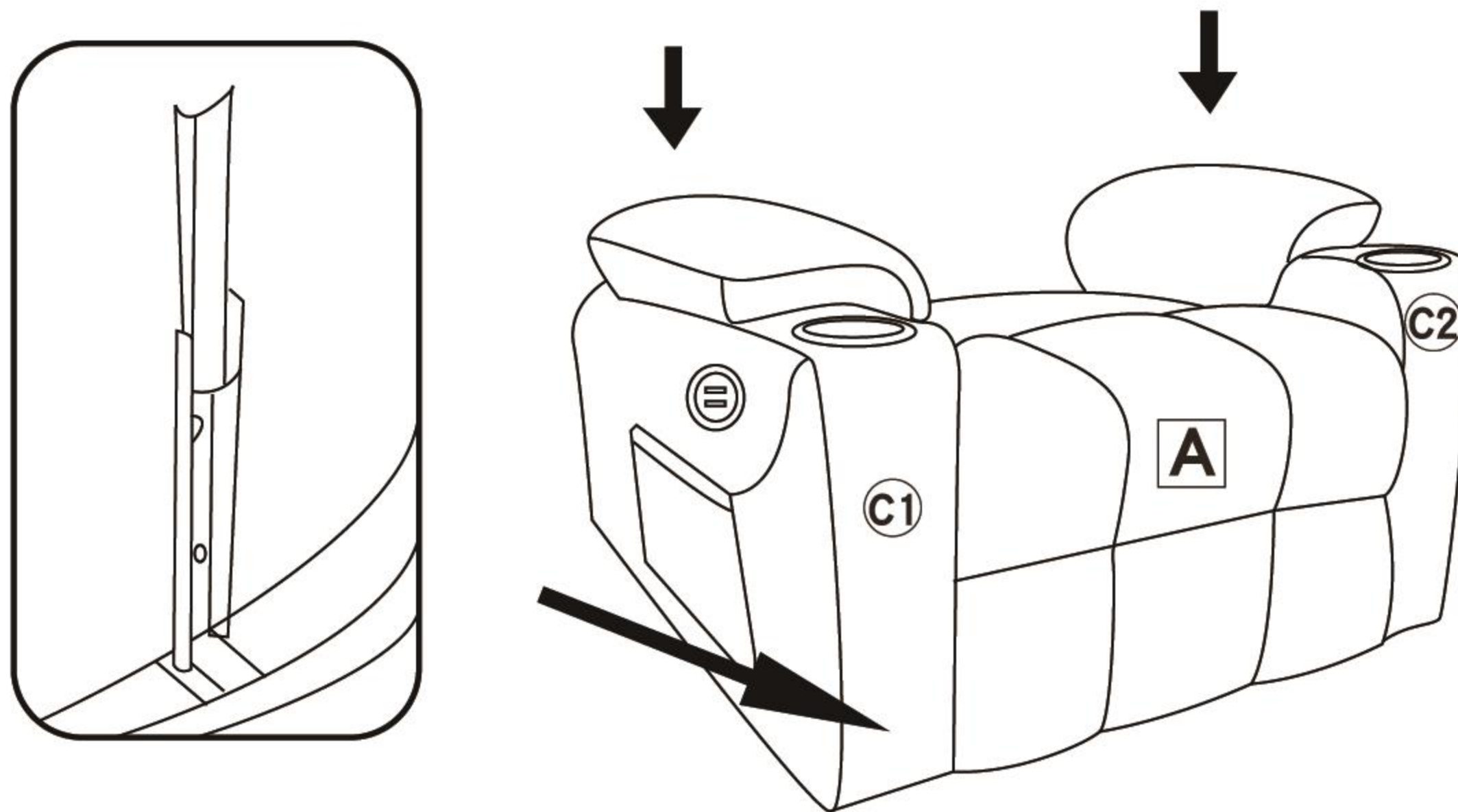

Step2

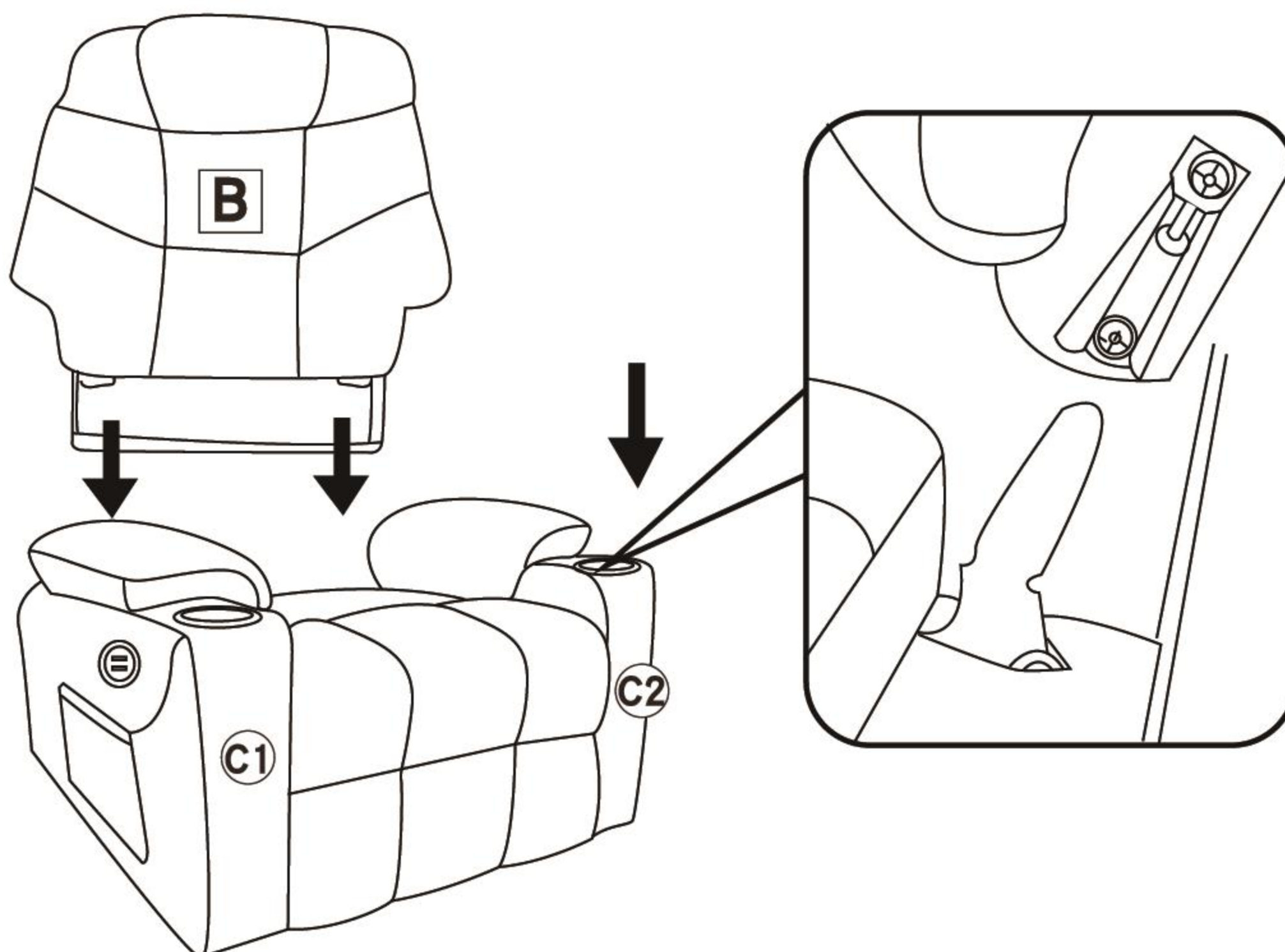

Sofa assembly instruction

Step3

The USB socket in the bottom of the sofa armrest.

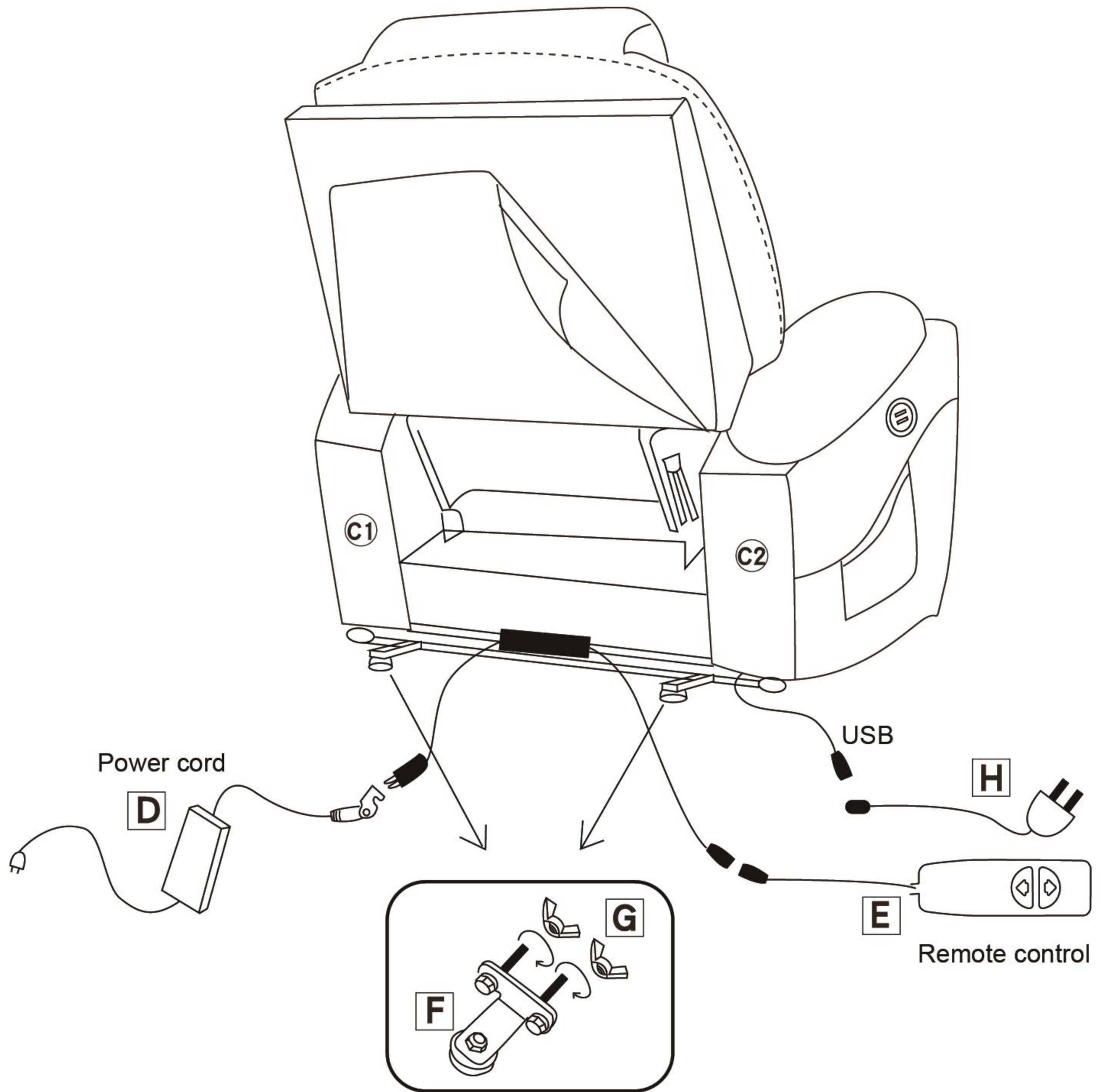

Sofa assembly instruction

How to recline?

Press

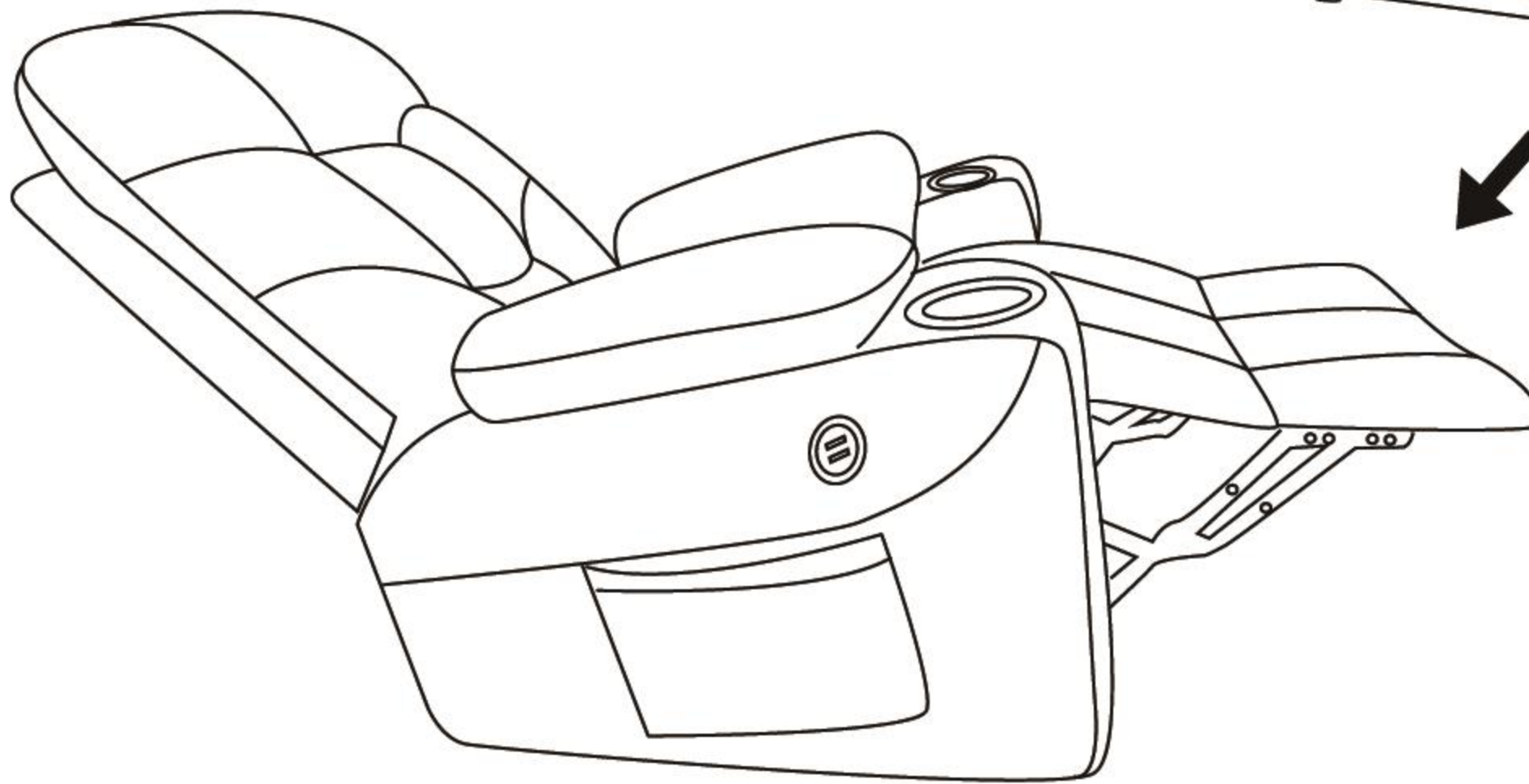
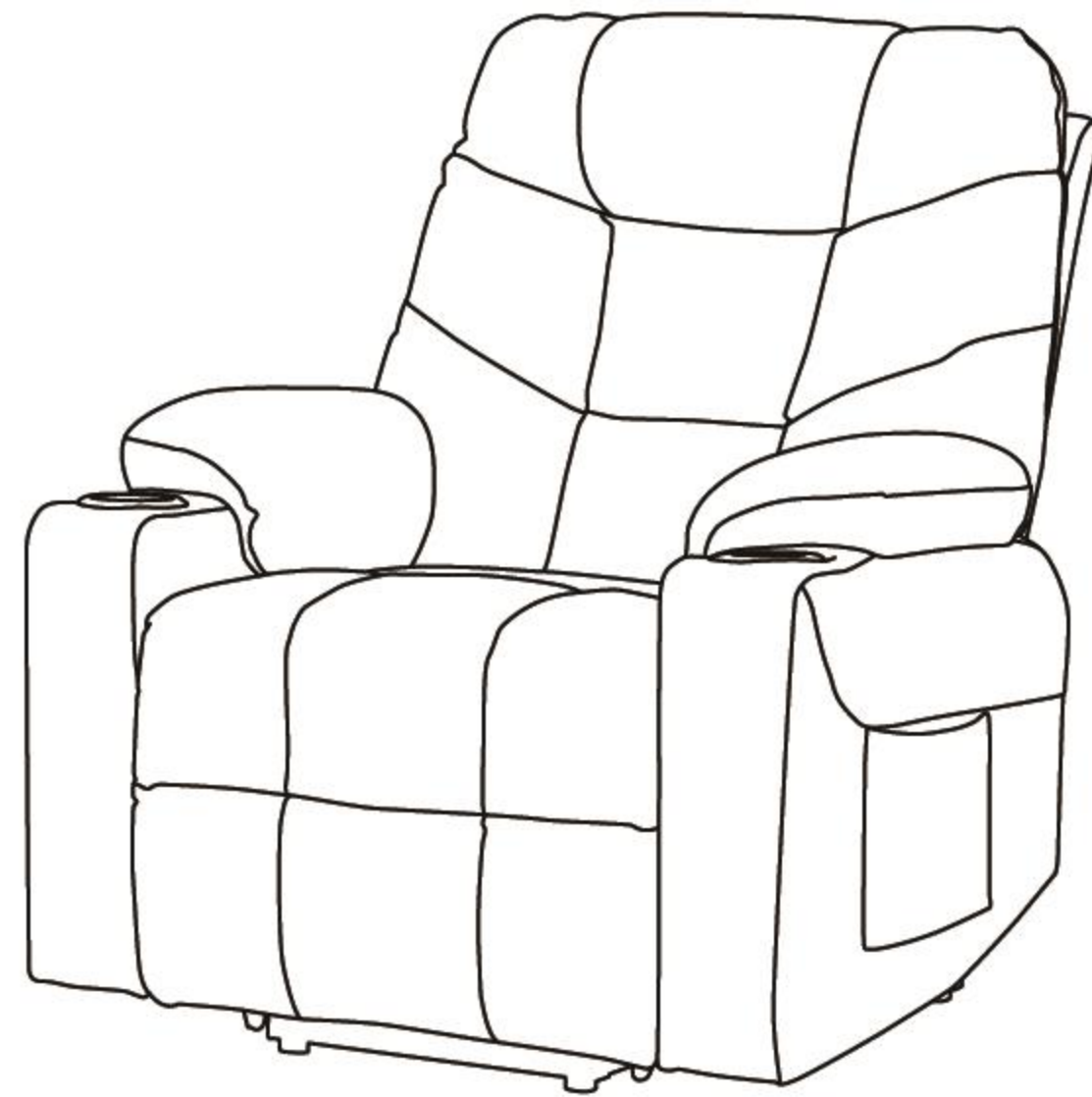
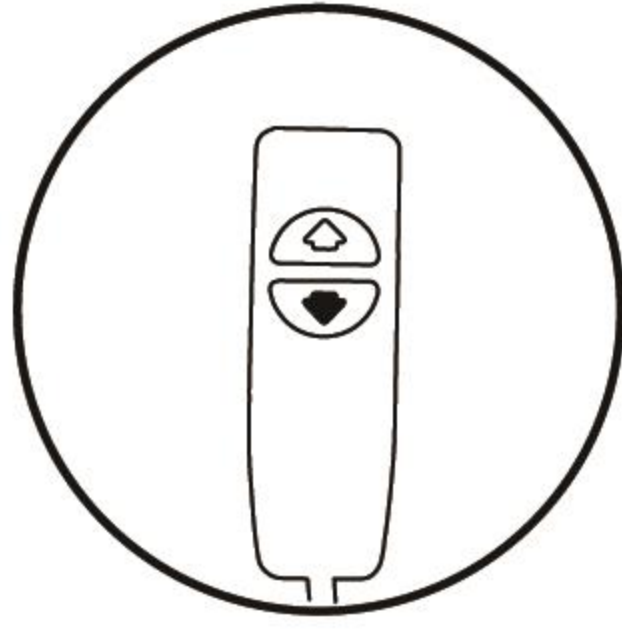

How to get footrest latch down an stand?

Press

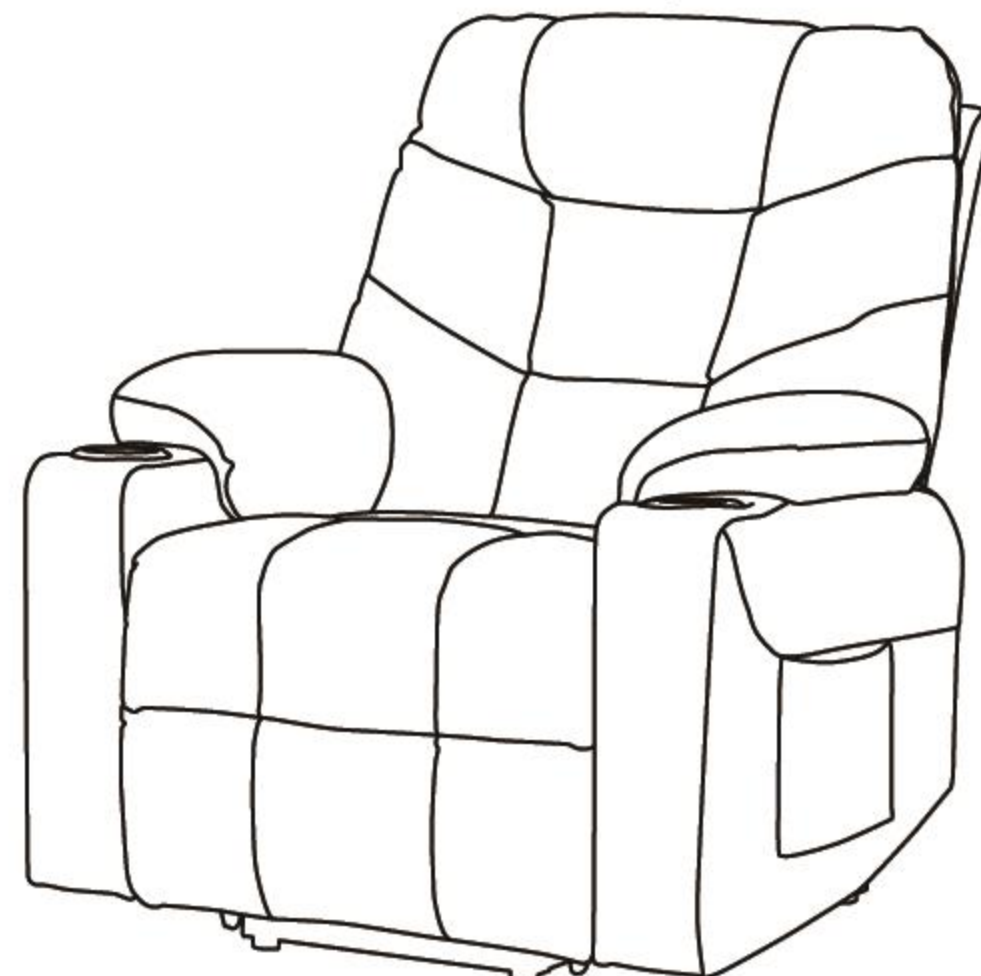
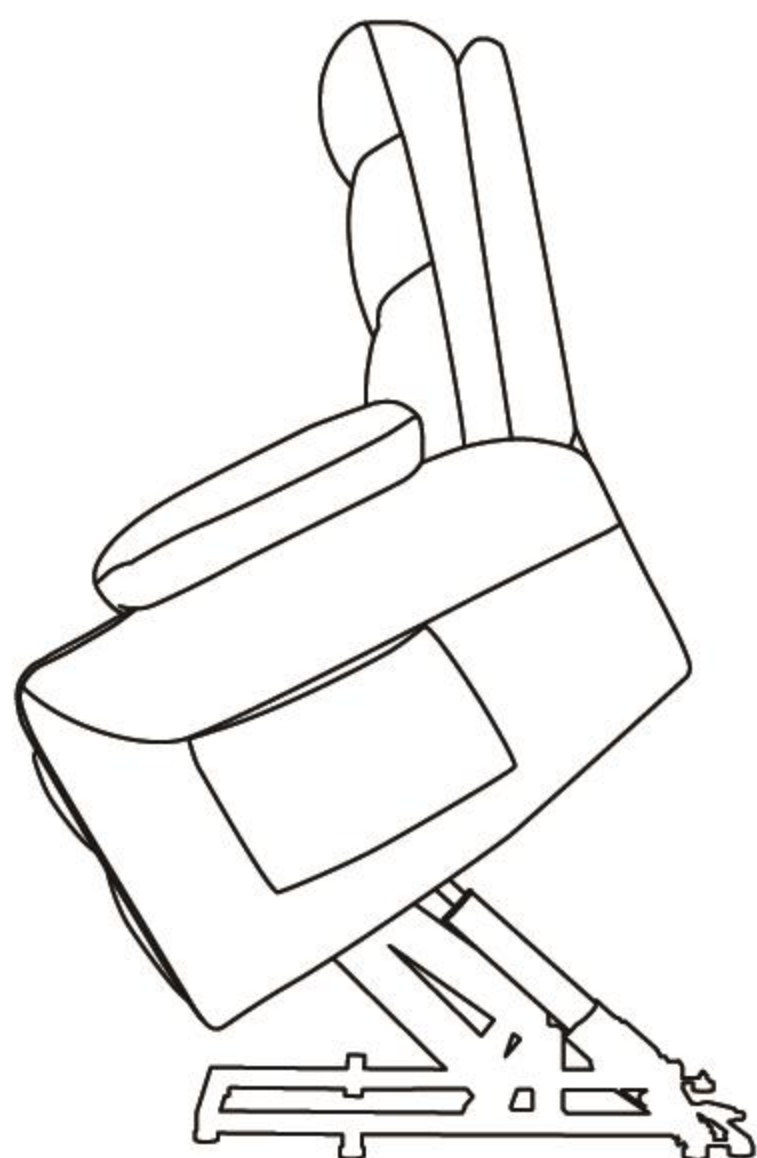
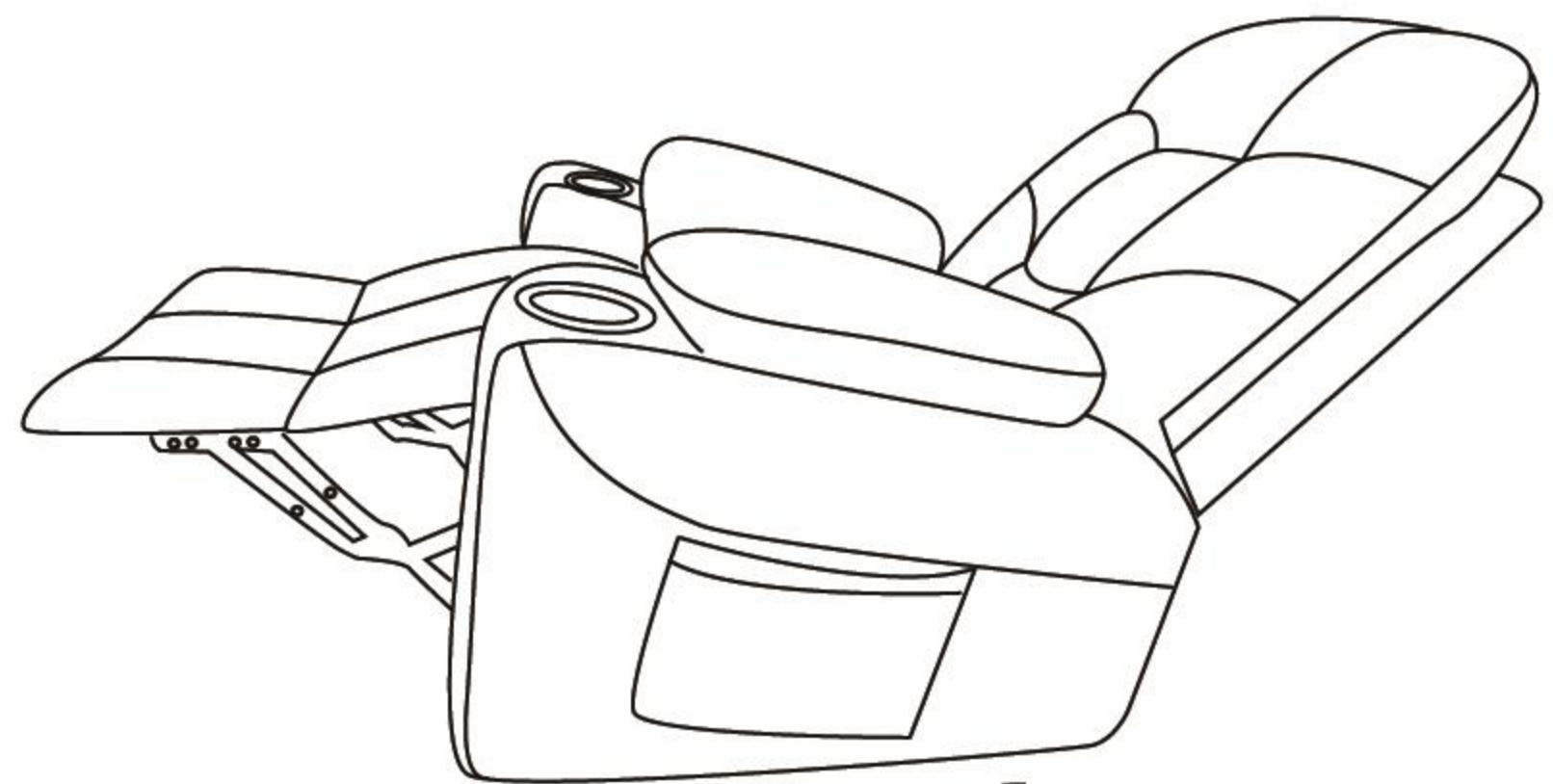
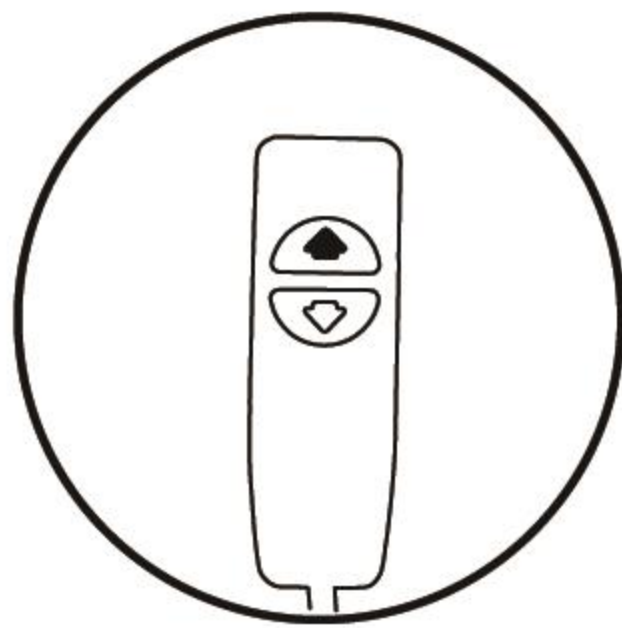

Sofa assembly instruction

How to use the remote control for the standing-up aid?

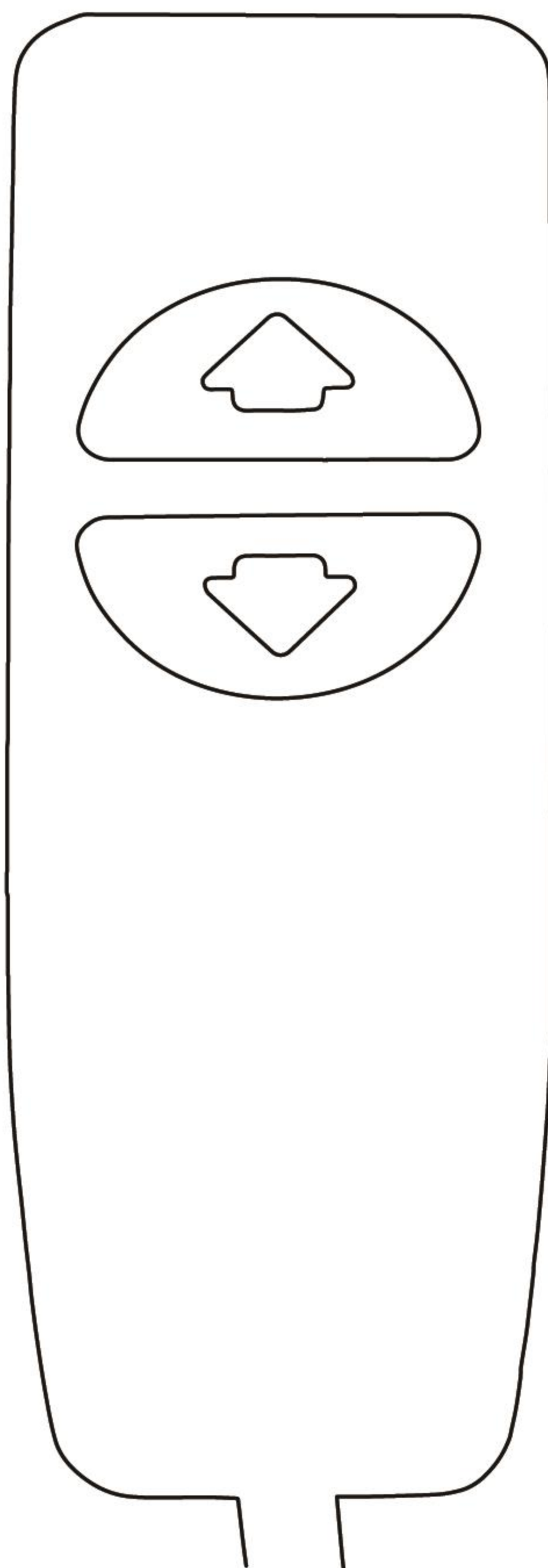



backrest straight, foot section down (sitting position);
keep pressing: tilt the sofa forwards (stand-up aid).

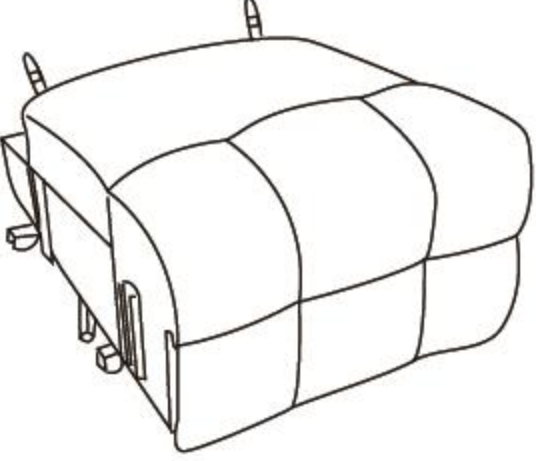
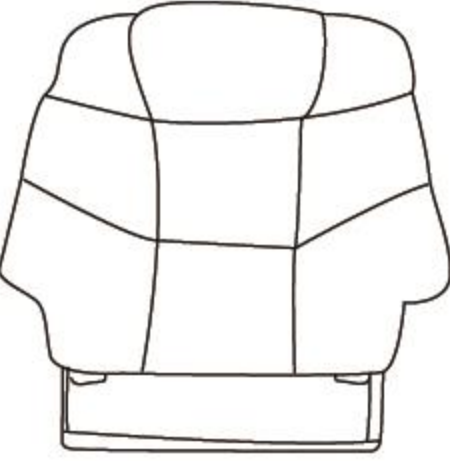
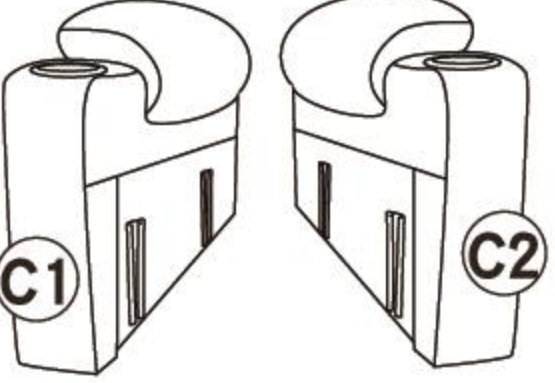
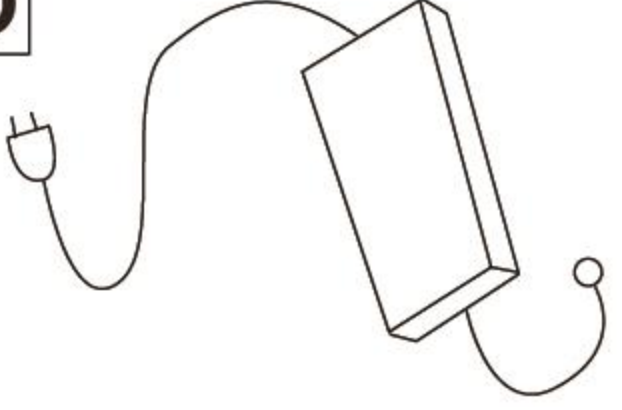
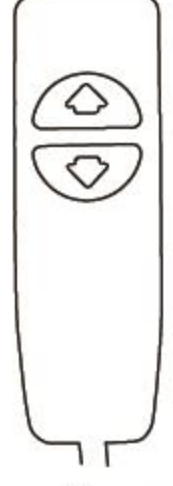
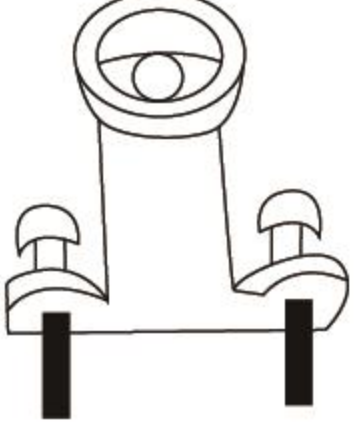

Move the backrest down, the foot section up (lying position).

Sofa assembly instruction

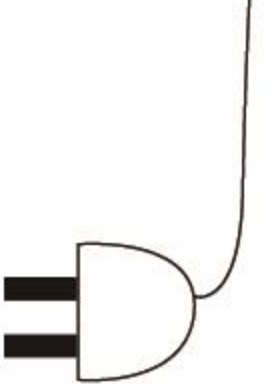
A  Sitzbasis 1x	B  Rückenlehne 1x	C  Armlehne links und rechts 2x	D  Netzteil 1x
E  Fernbedienung 1x	F  Teil 1 2x	G  Teil 2 4x	H  Power Stecker 1x

Schritt 1

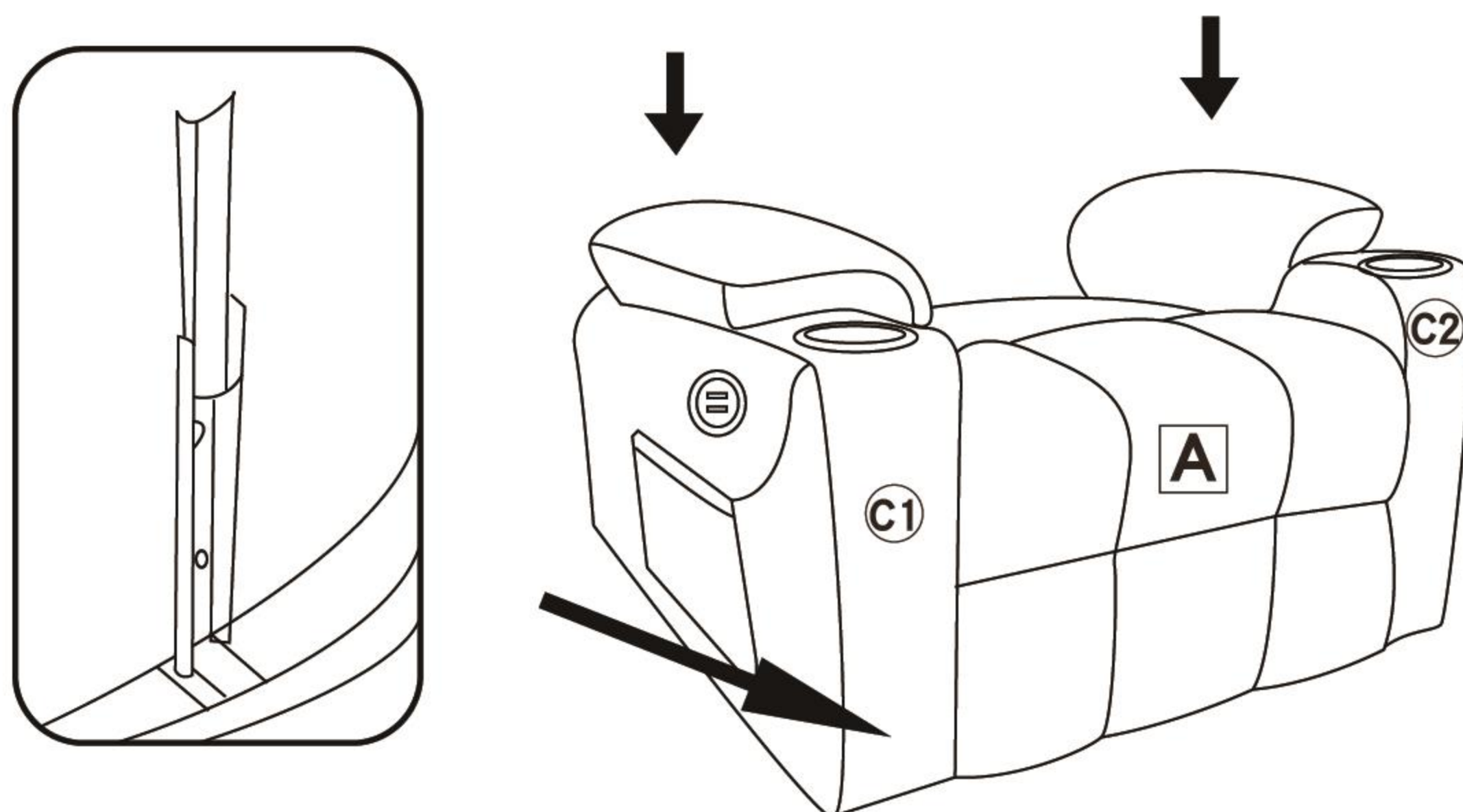

Schritt 2

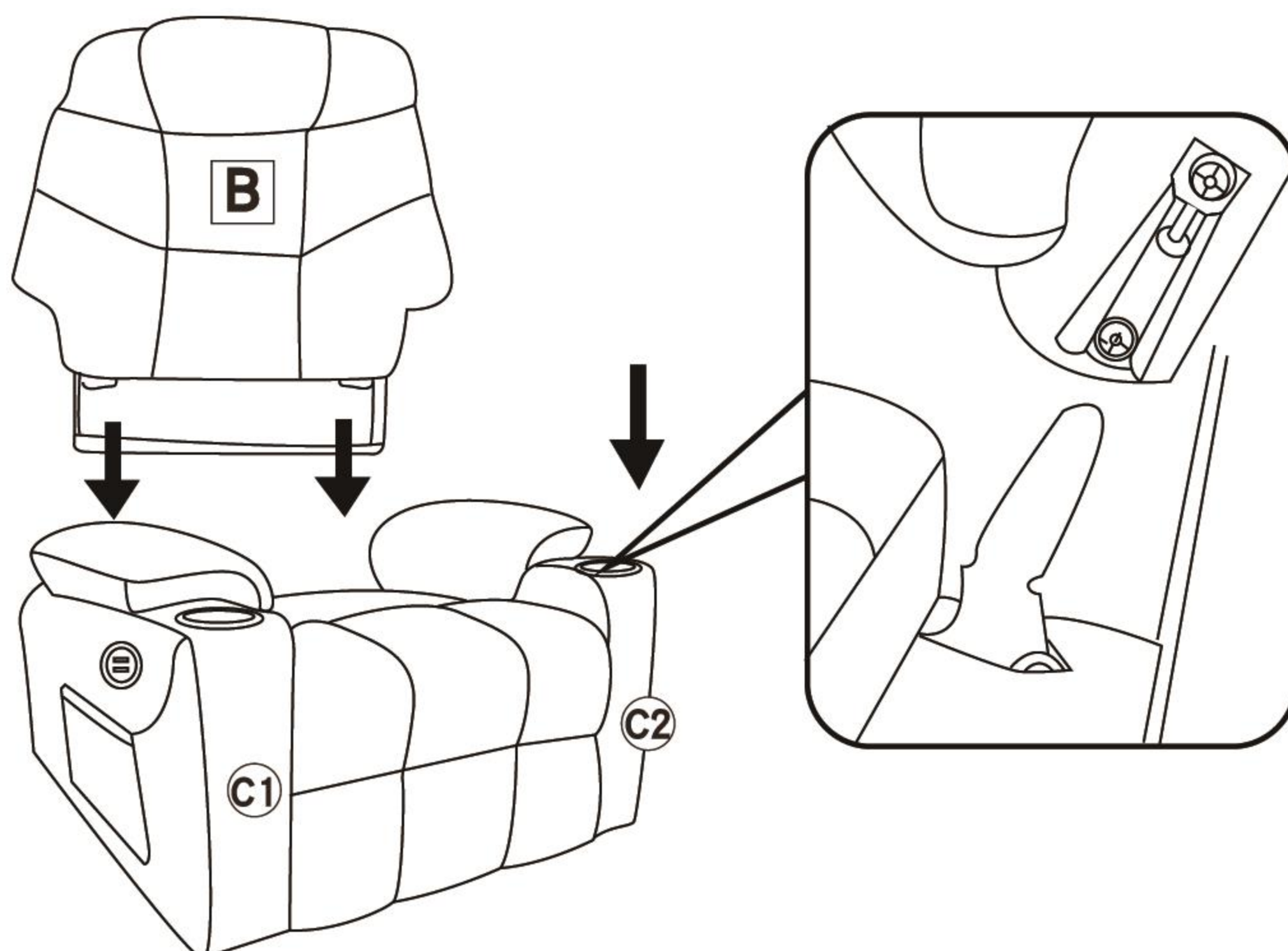

Sofa assembly instruction

Schritt 3

Die USB-Buchse befindet sich an der Unterseite der Armlehne.

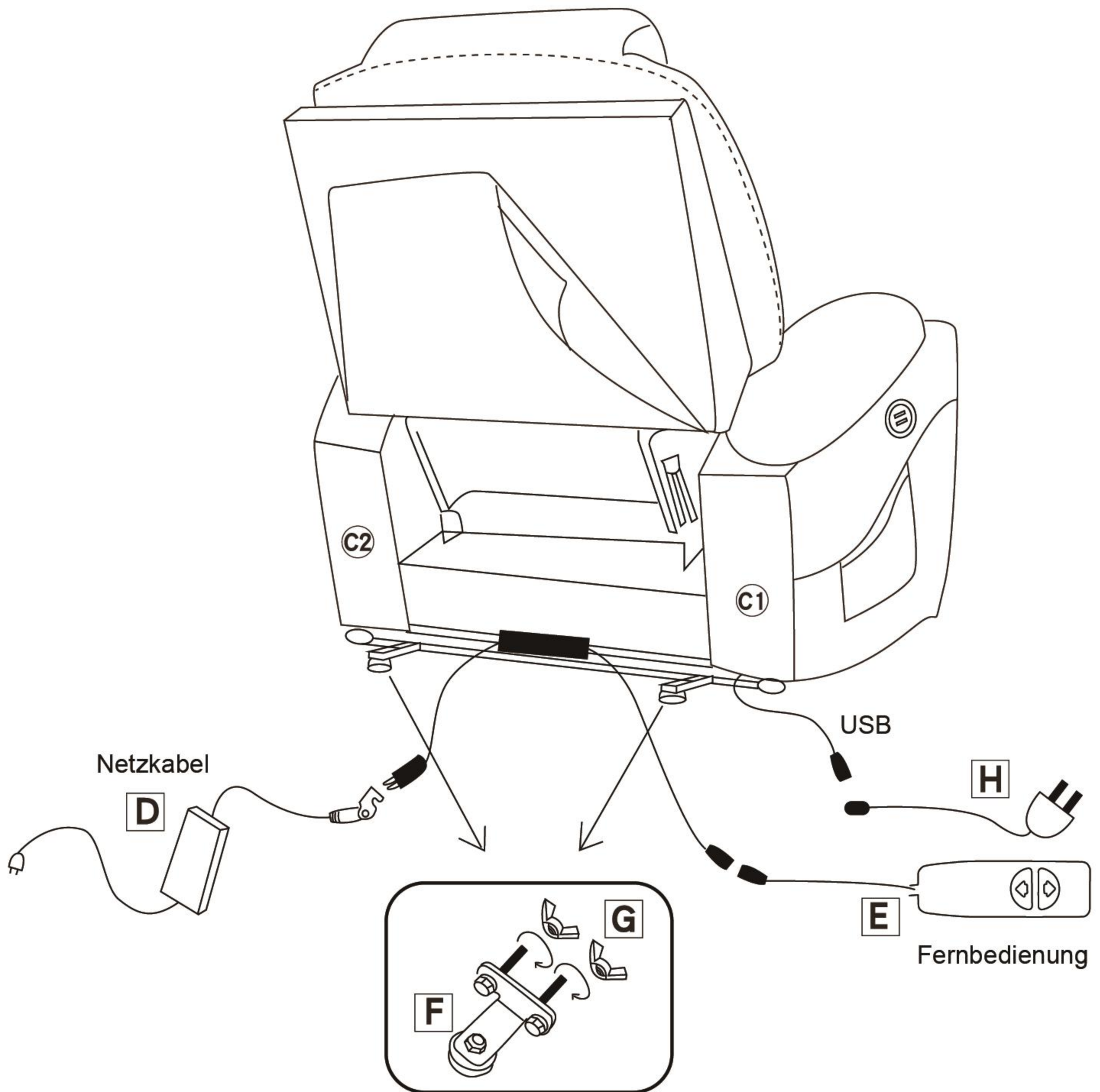

Sofa assembly instruction

Wie man sich zurücklehnt?

Drücken

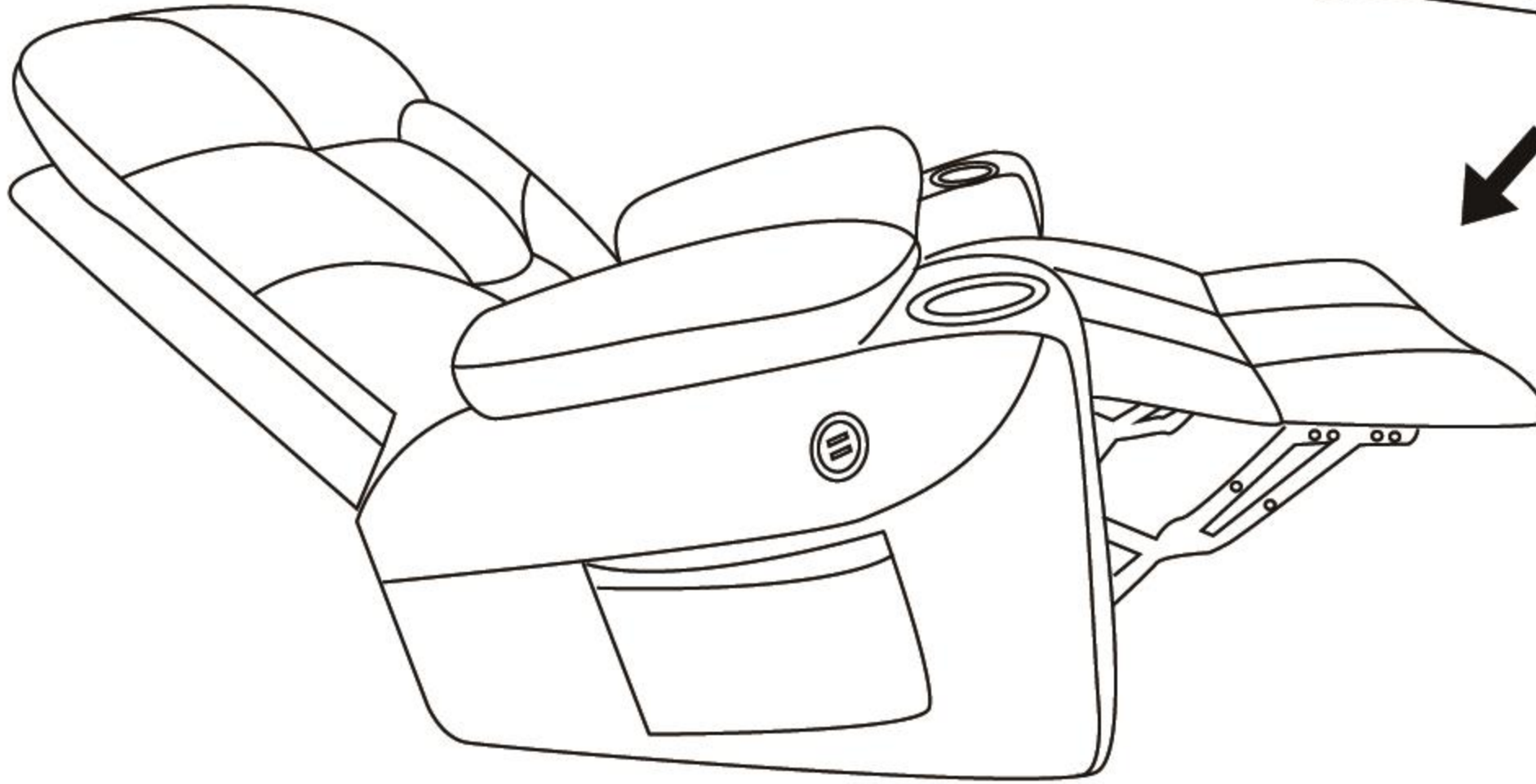
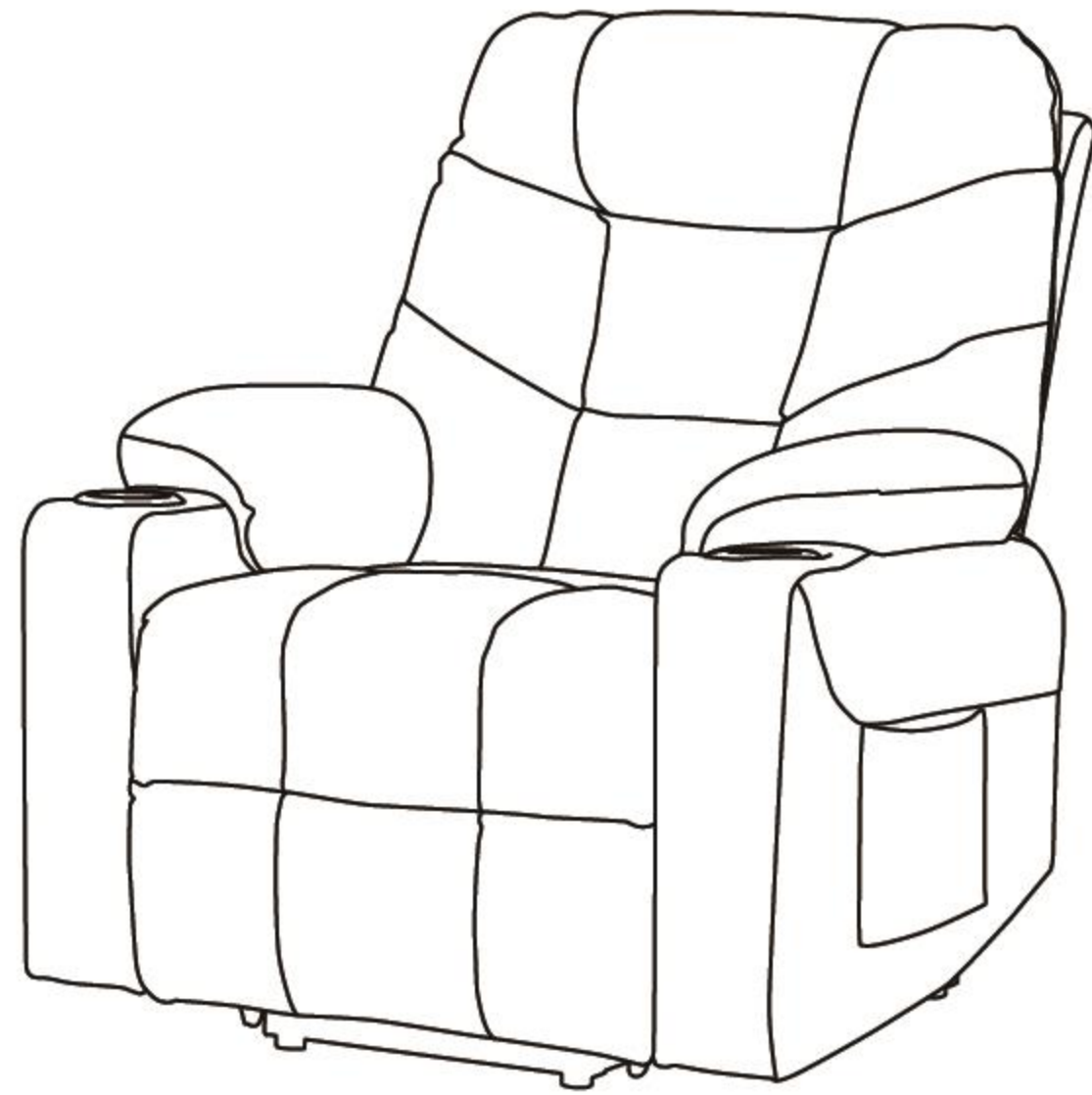
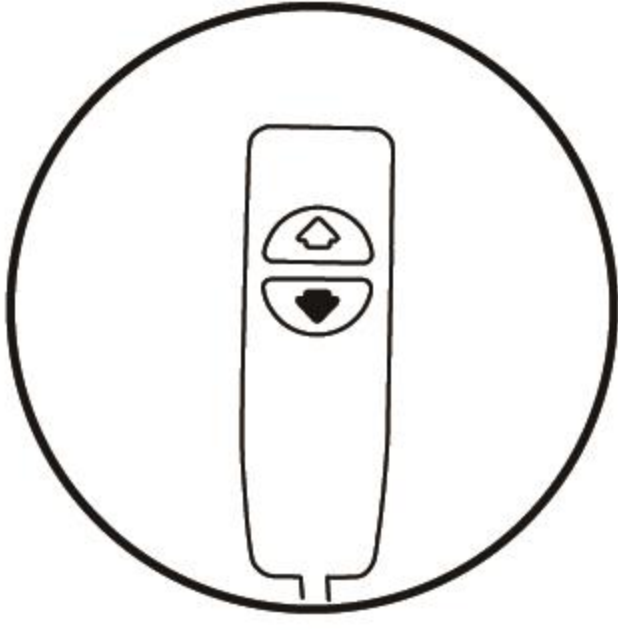

Wie man die Fußstütze einrastet lässt und steht?

Drücken

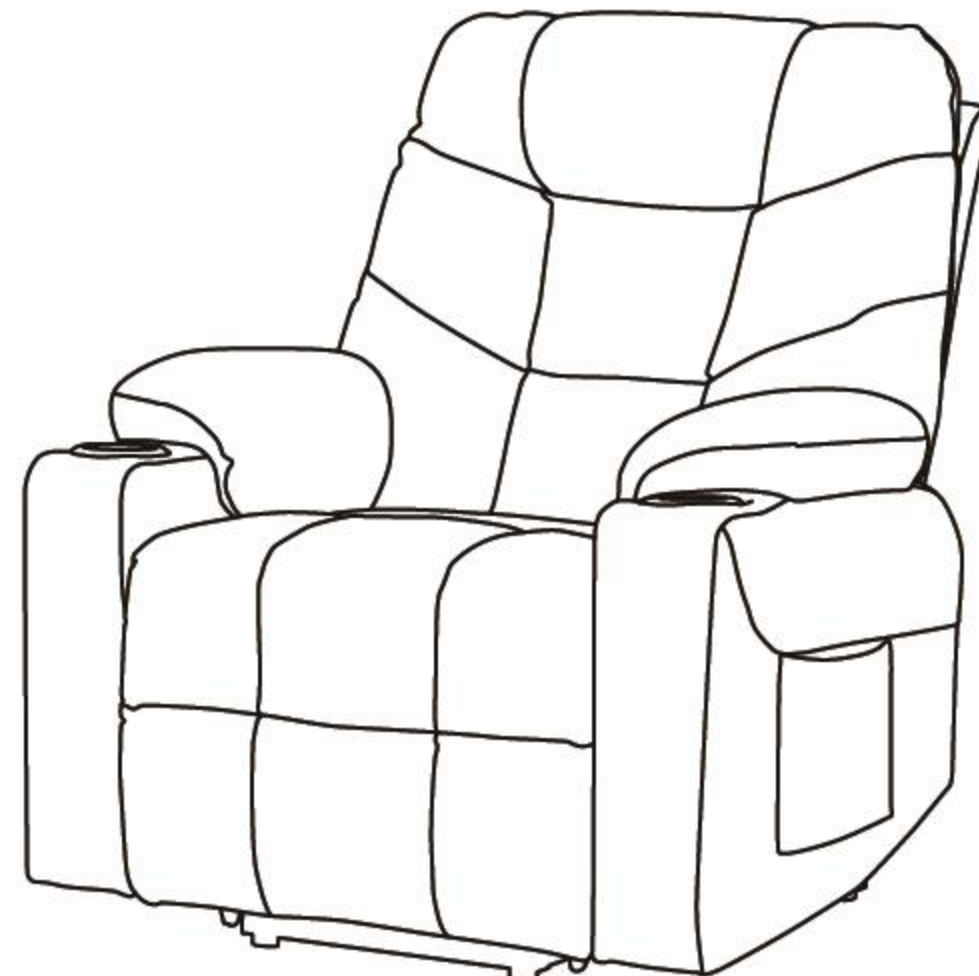
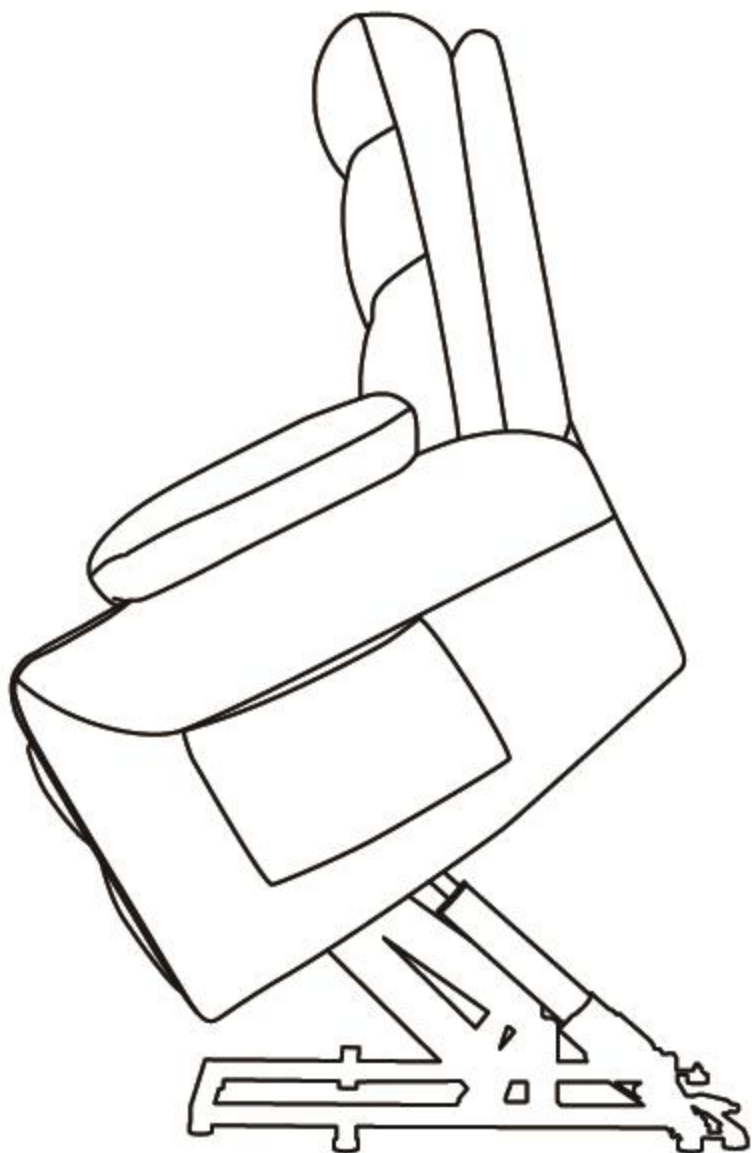
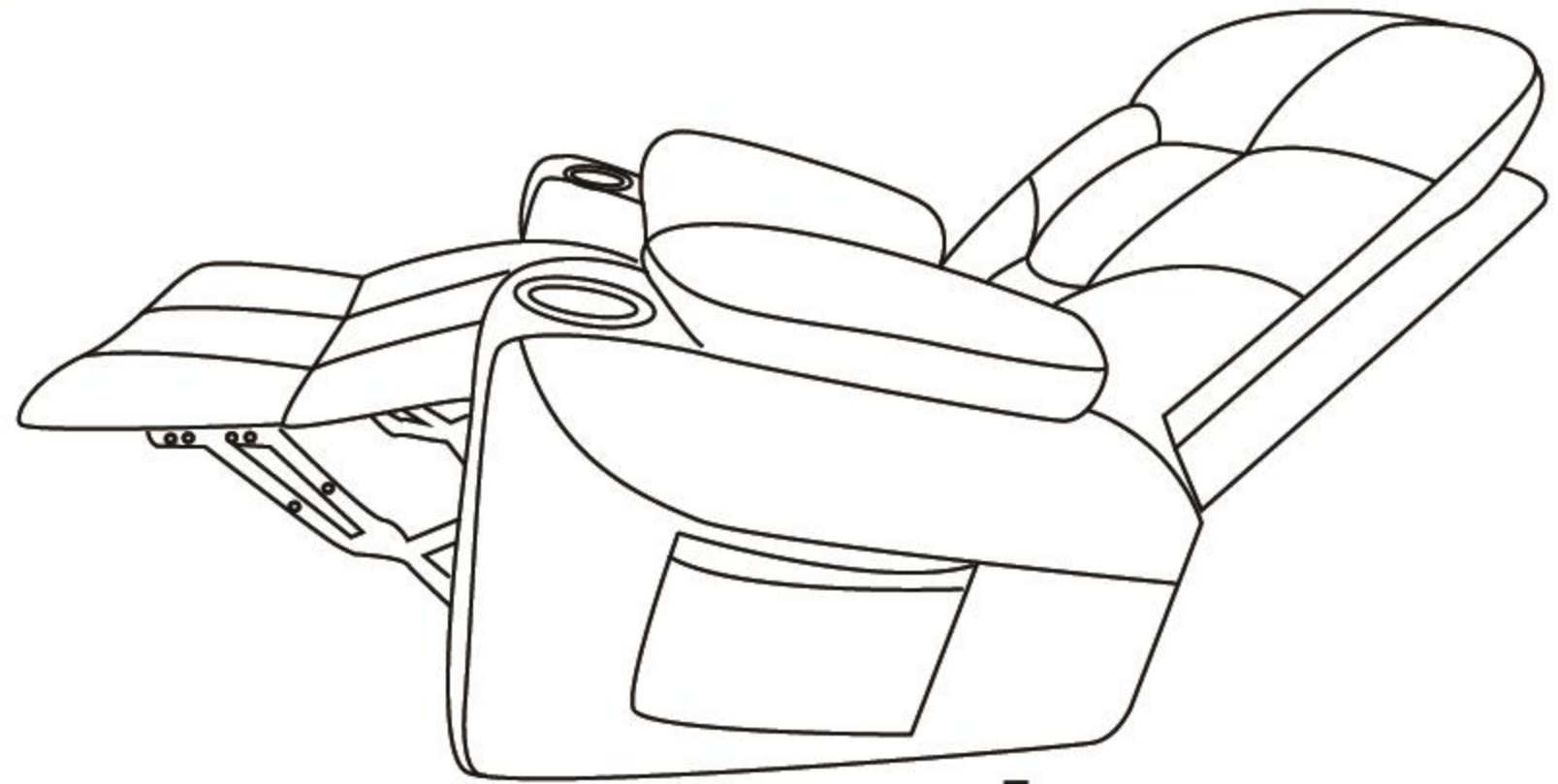
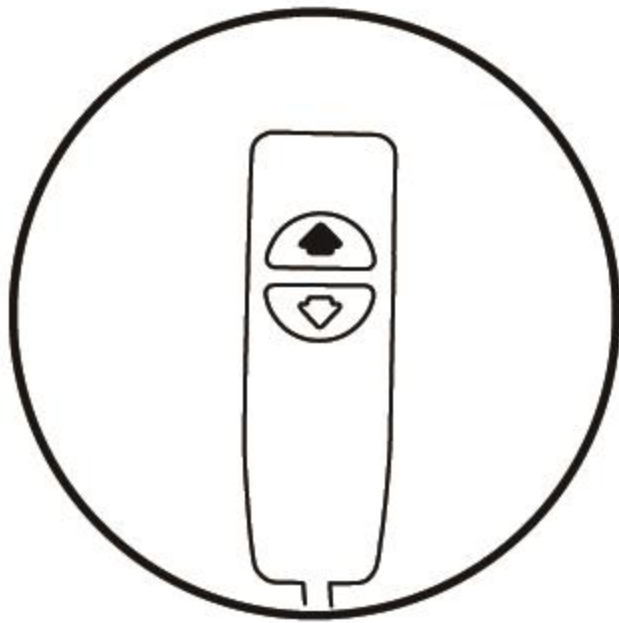

Sofa assembly instruction

Wie benutzt man die Fernbedienung für die Aufstehhilfe?

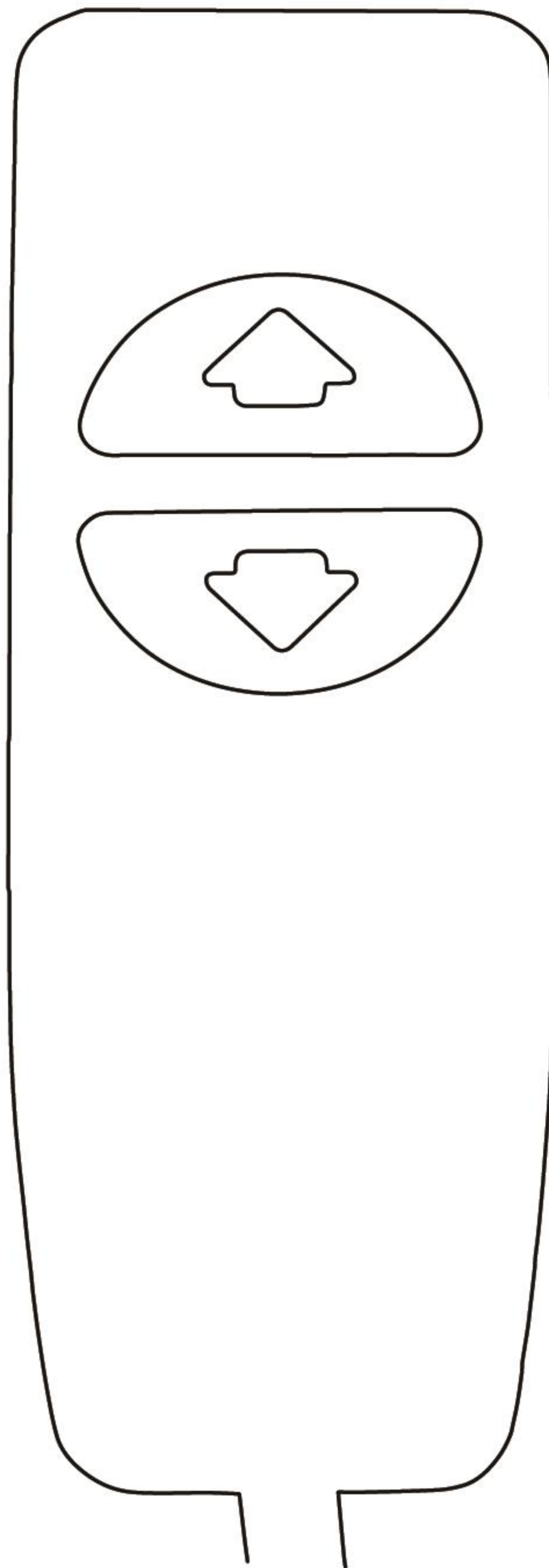





Rückenlehne gerade, Fußteil nach unten (Sitzposition);
weiter drücken: Sofa nach vorne neigen (Aufstehhilfe).

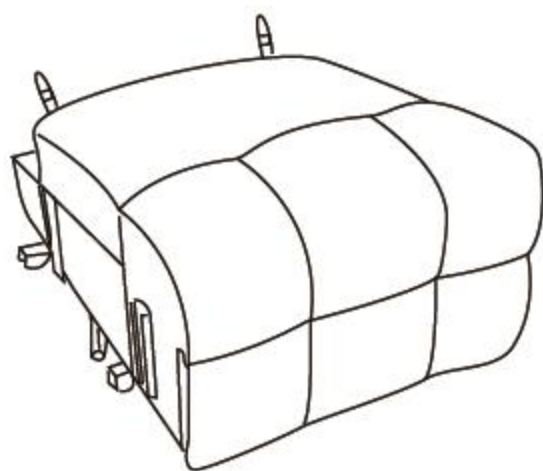
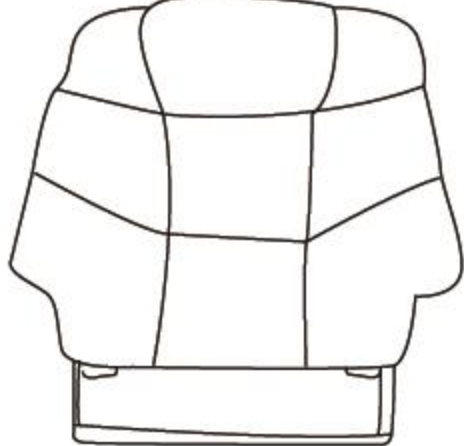
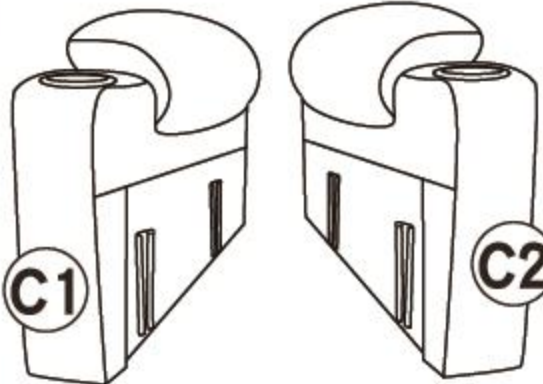
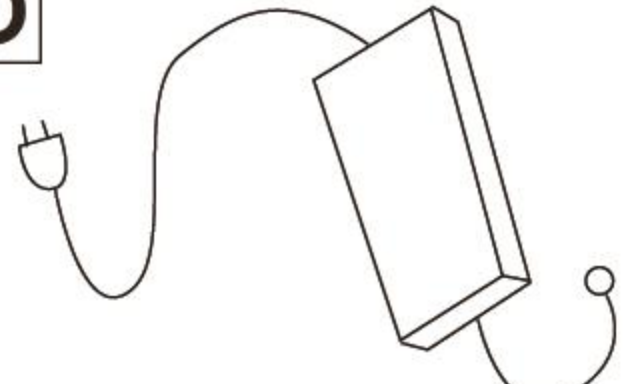

Rückenlehne nach unten, Fußteil nach oben stellen (Liegeposition)

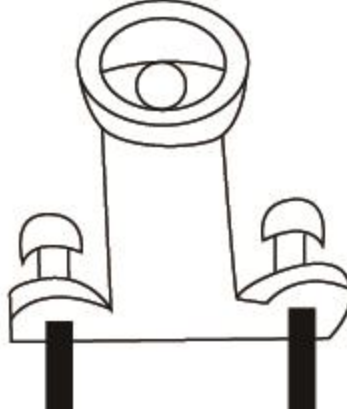
Sofa assembly instruction

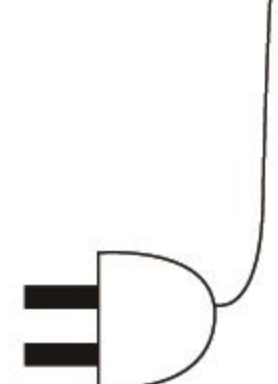
A  Base de la présidence 1x	B  Dossier 1x	C  Accoudoir gauche et droit 2x	D  Cordon d'alimentation 1x
E  Télécommande 1x	F  Partie1 2x	G  Partie2 4x	H  Câble d'alimentation 1x

Étape 1

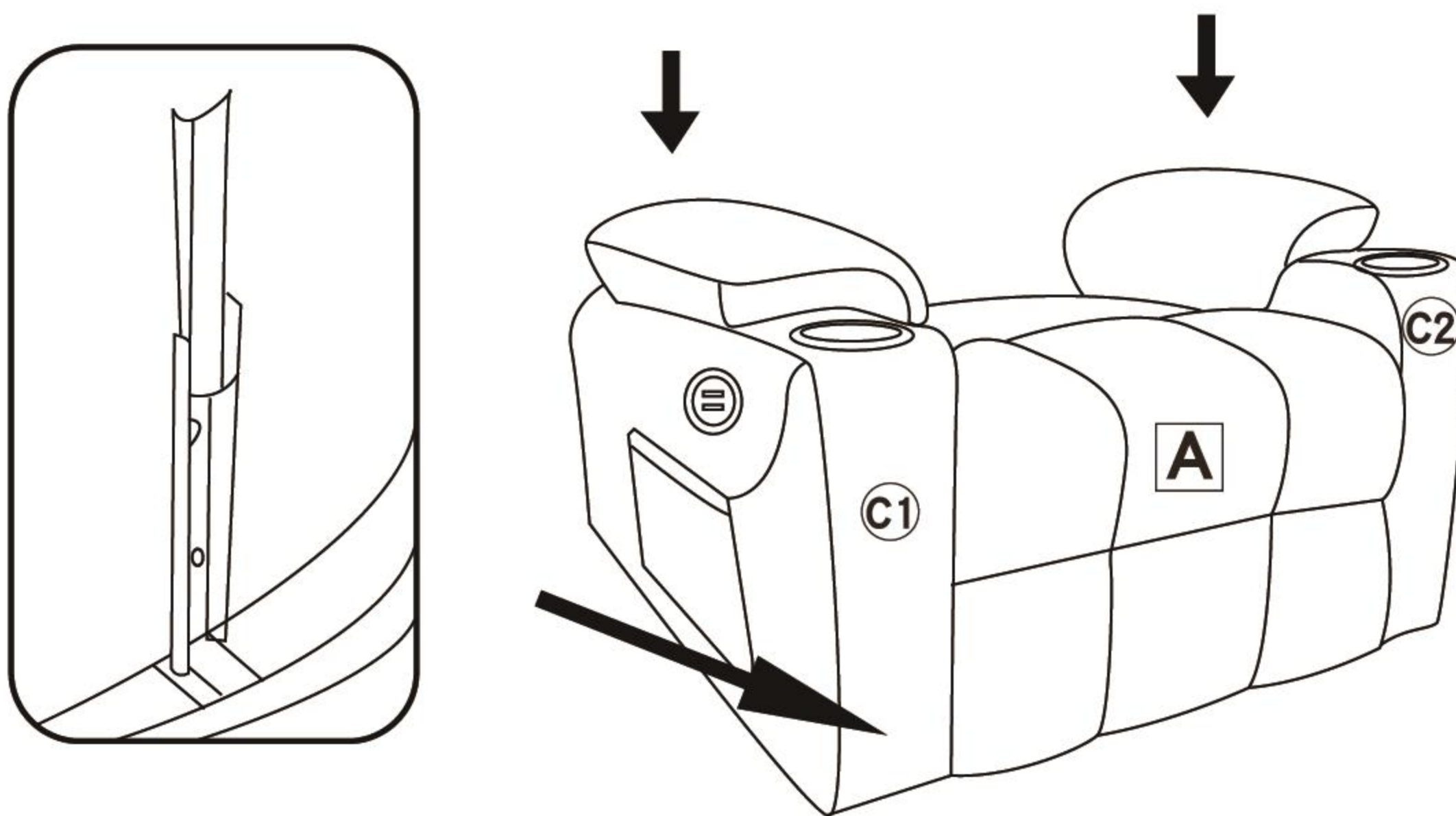

Étape 2

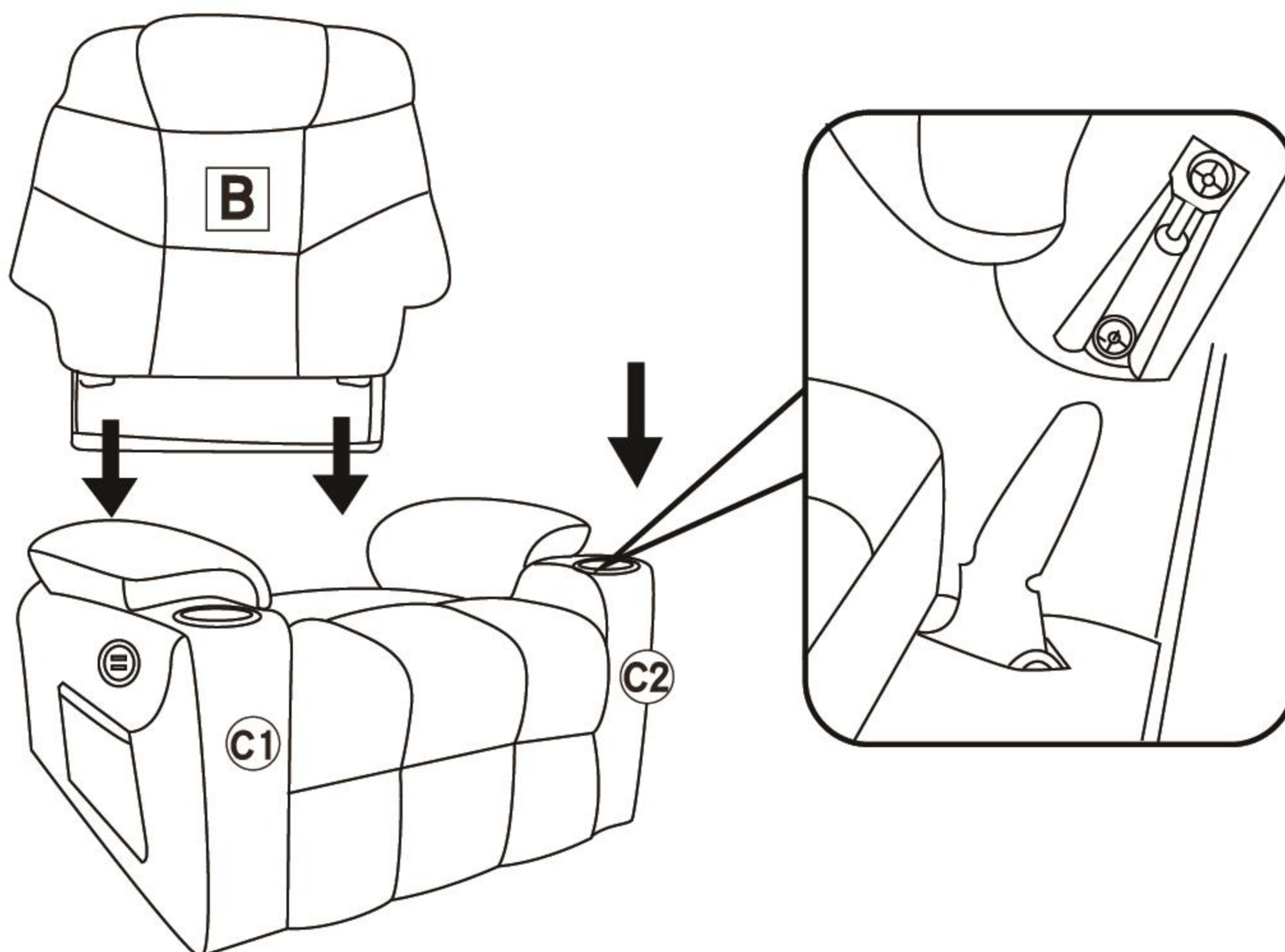

Sofa assembly instruction

Étape 3

La prise USB au bas de l'accoudoir du canapé.

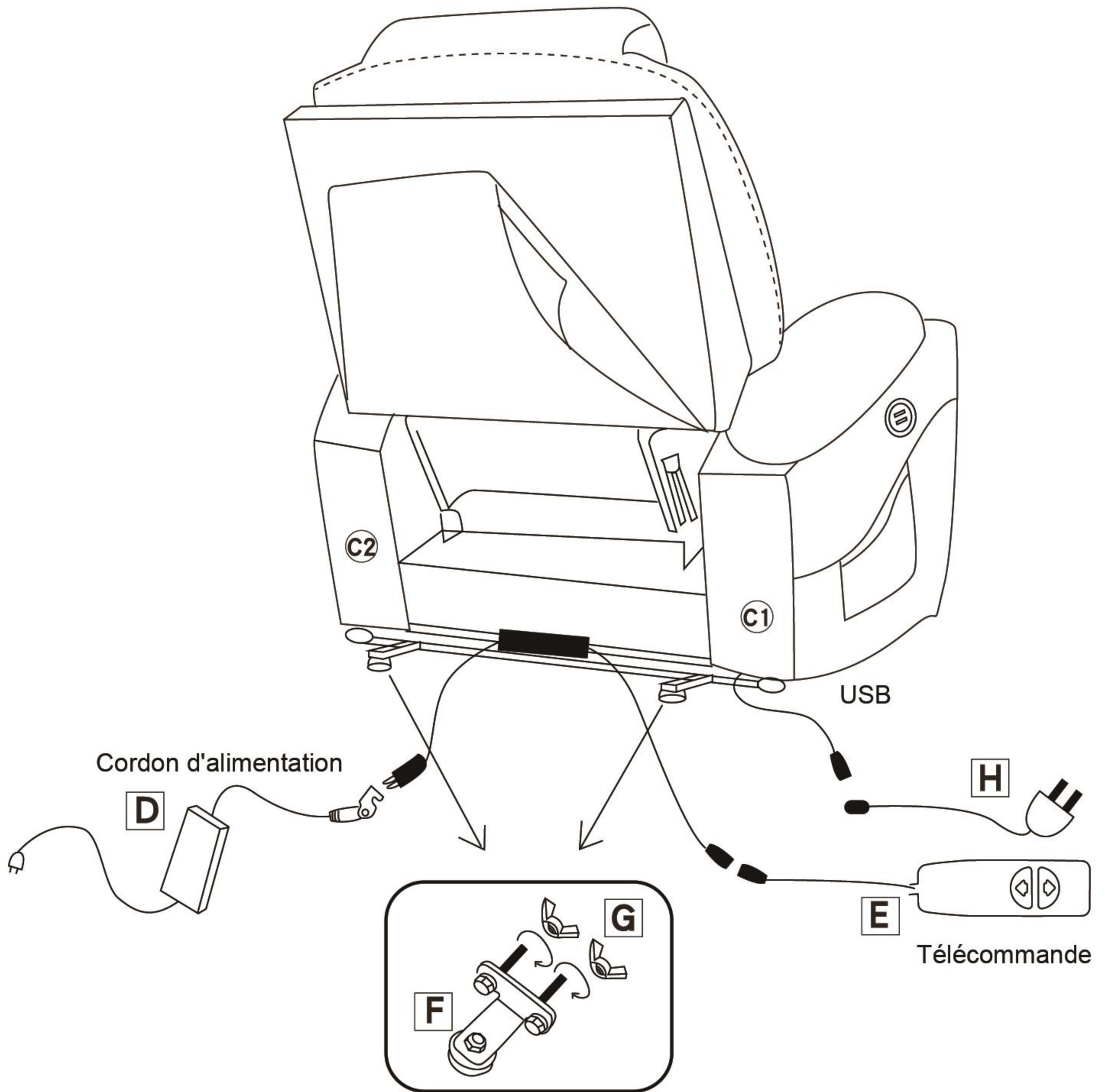

Sofa assembly instruction

Comment recharger?

Presse

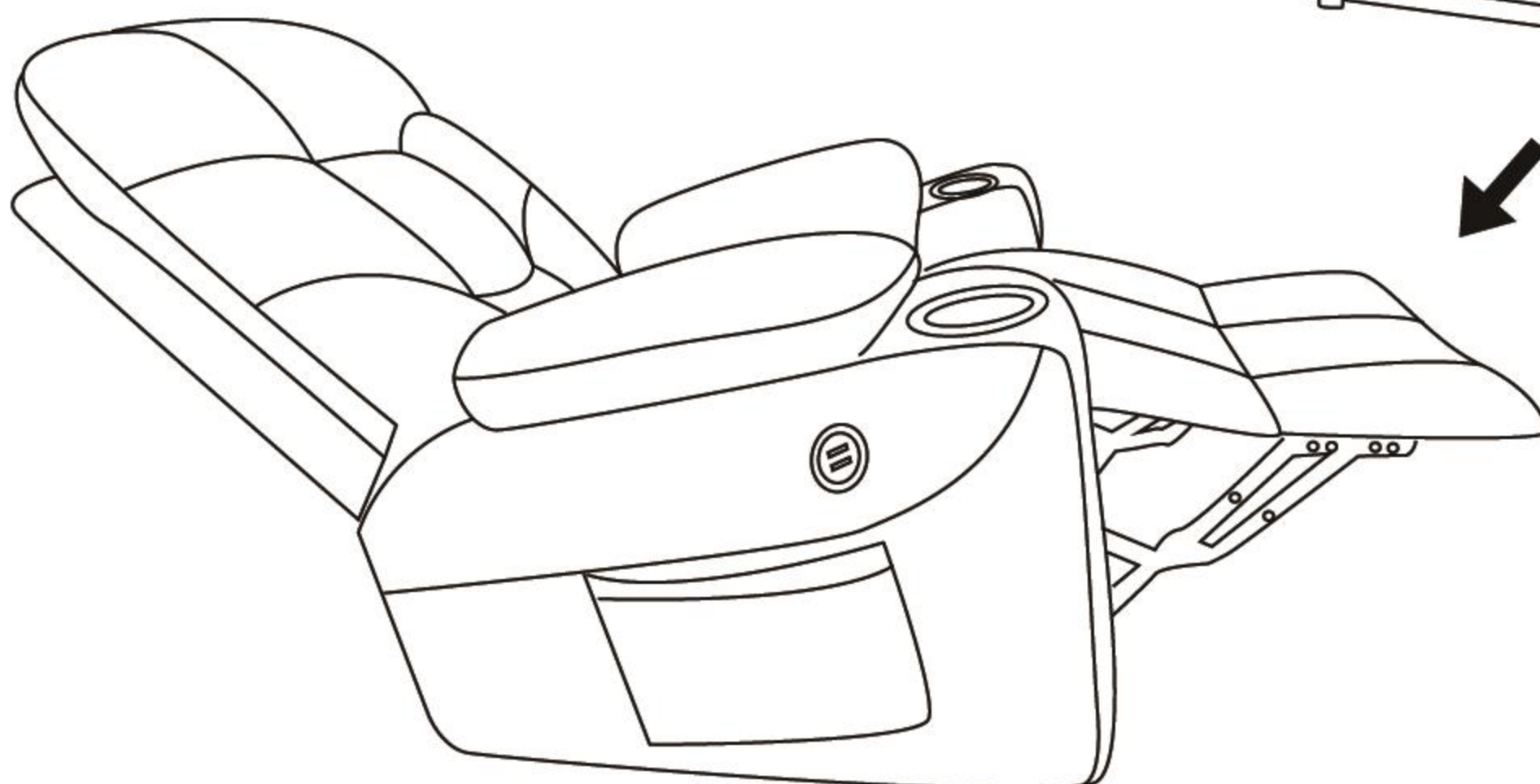
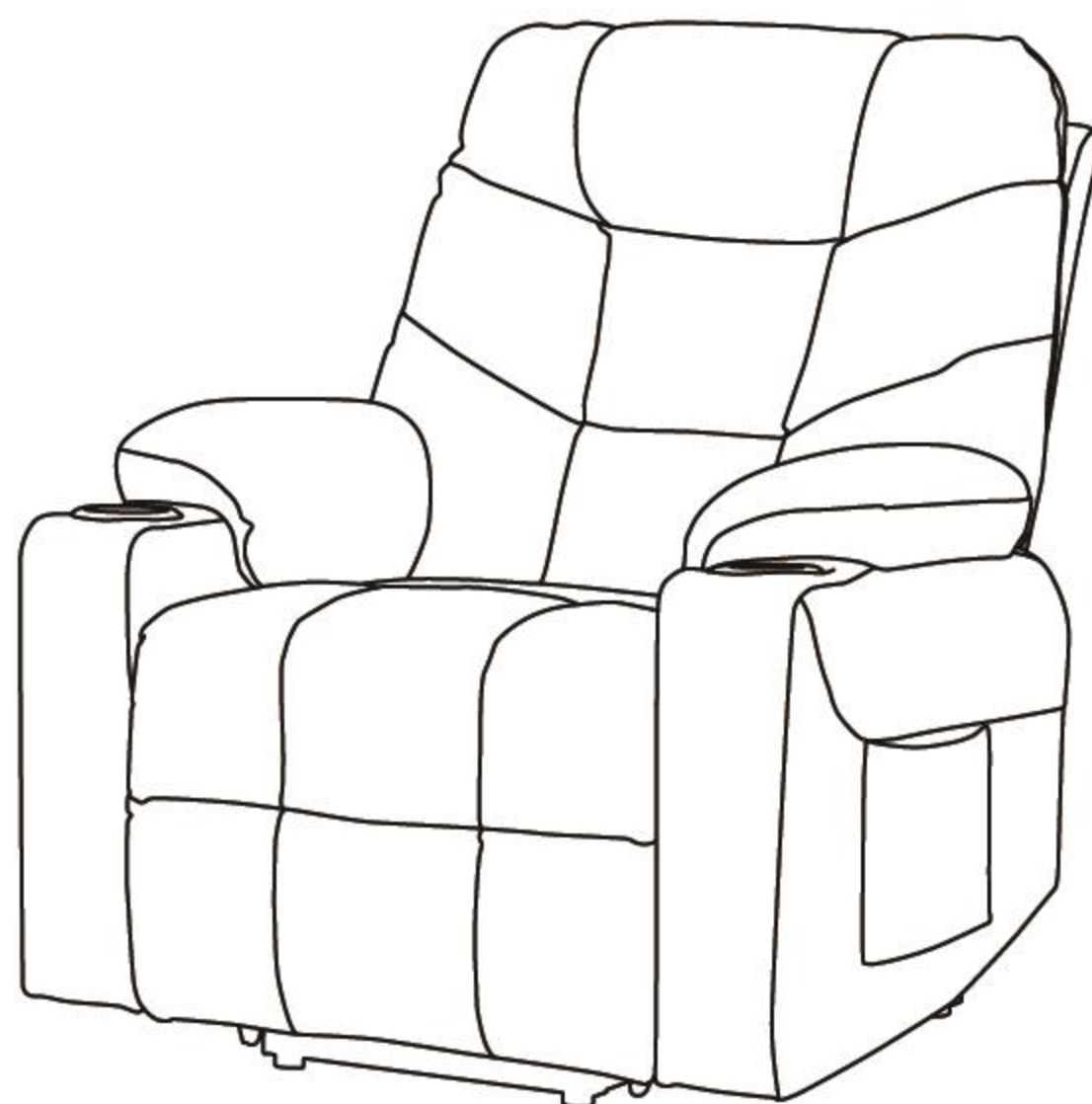
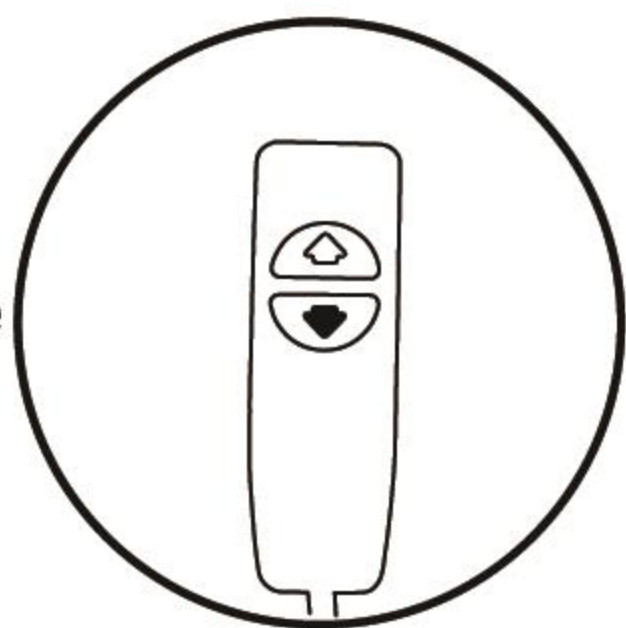

Comment faire pour que le repose-pied se verrouille sur un support?

Press

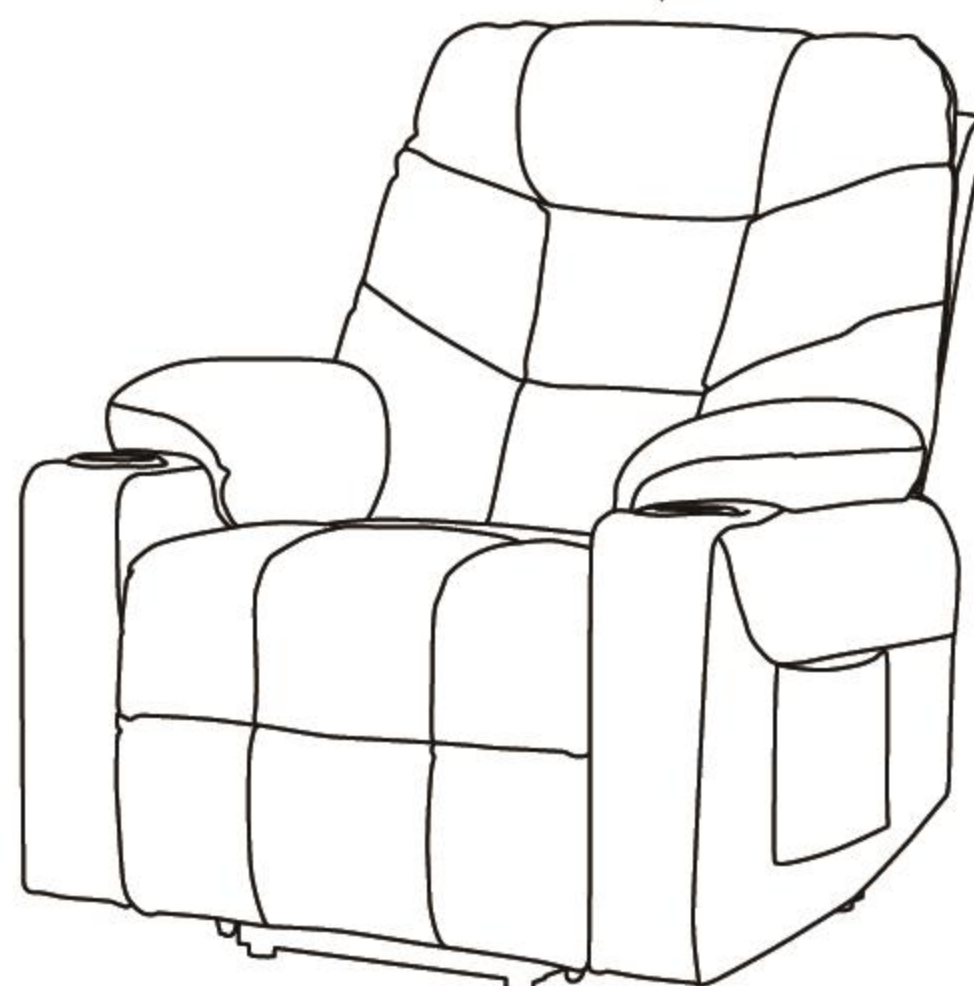
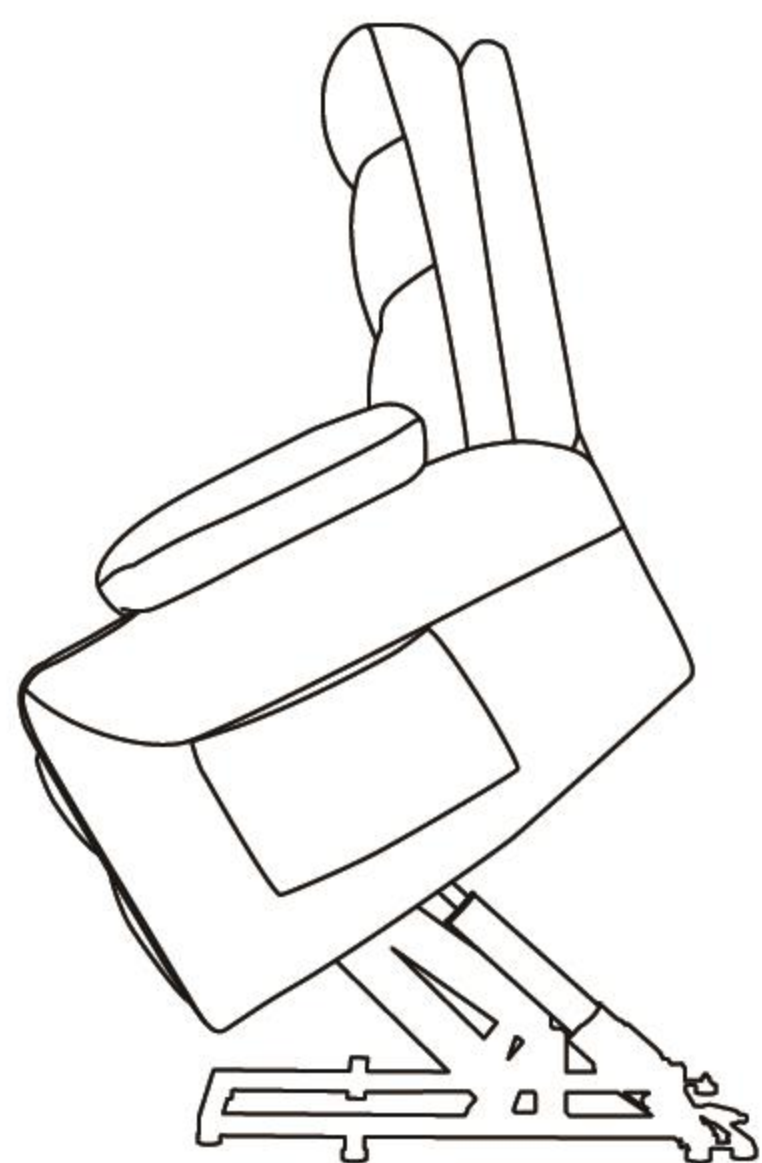
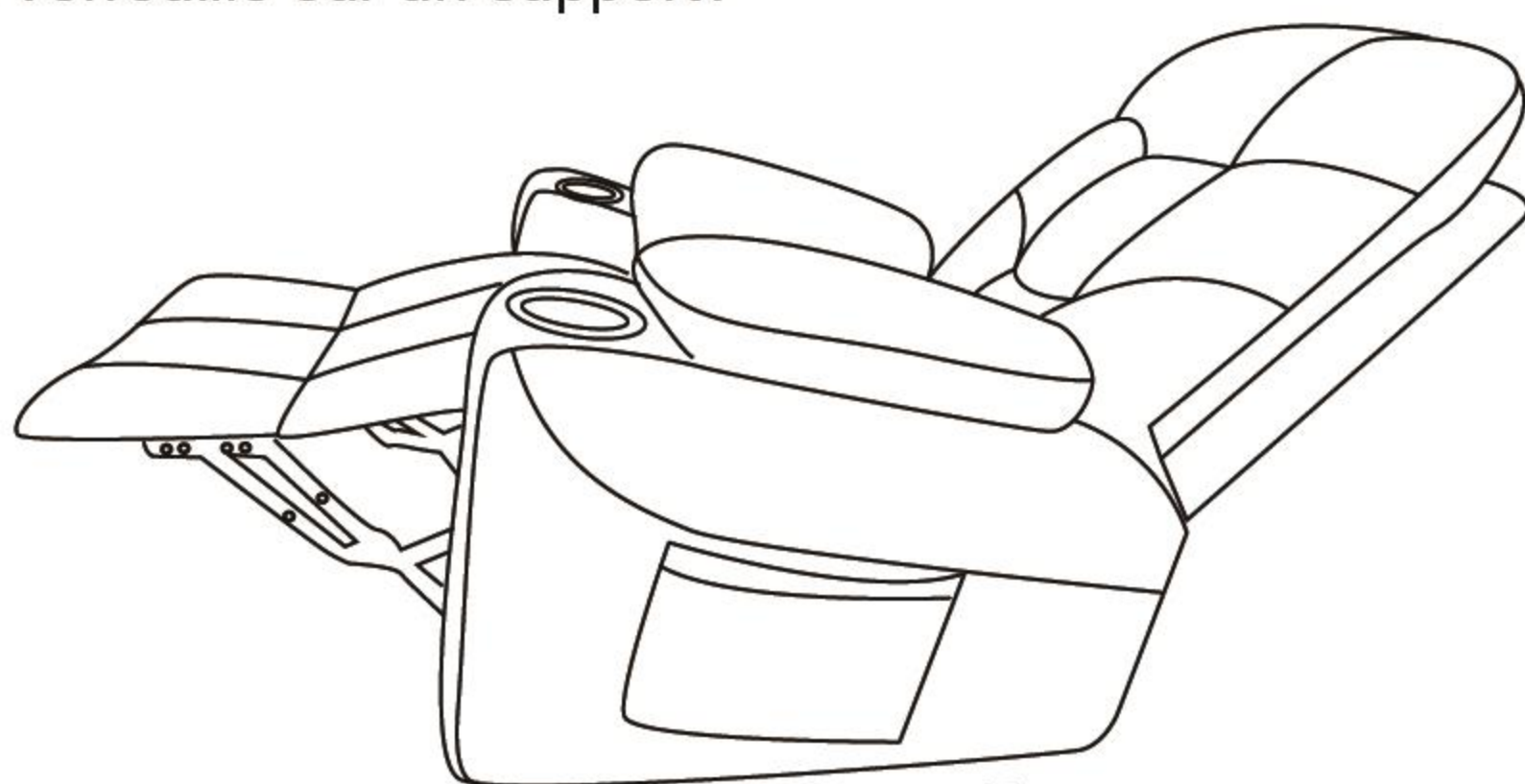
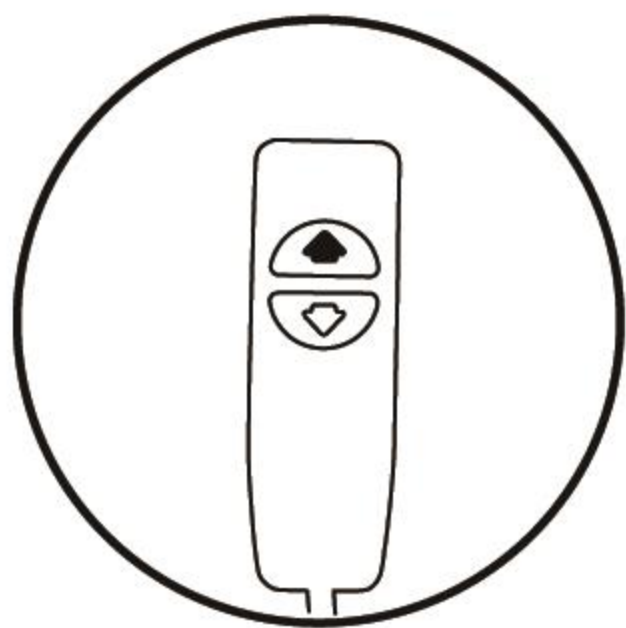

Sofa assembly instruction

Comment utiliser la télécommande pour l'aide d'urgence?

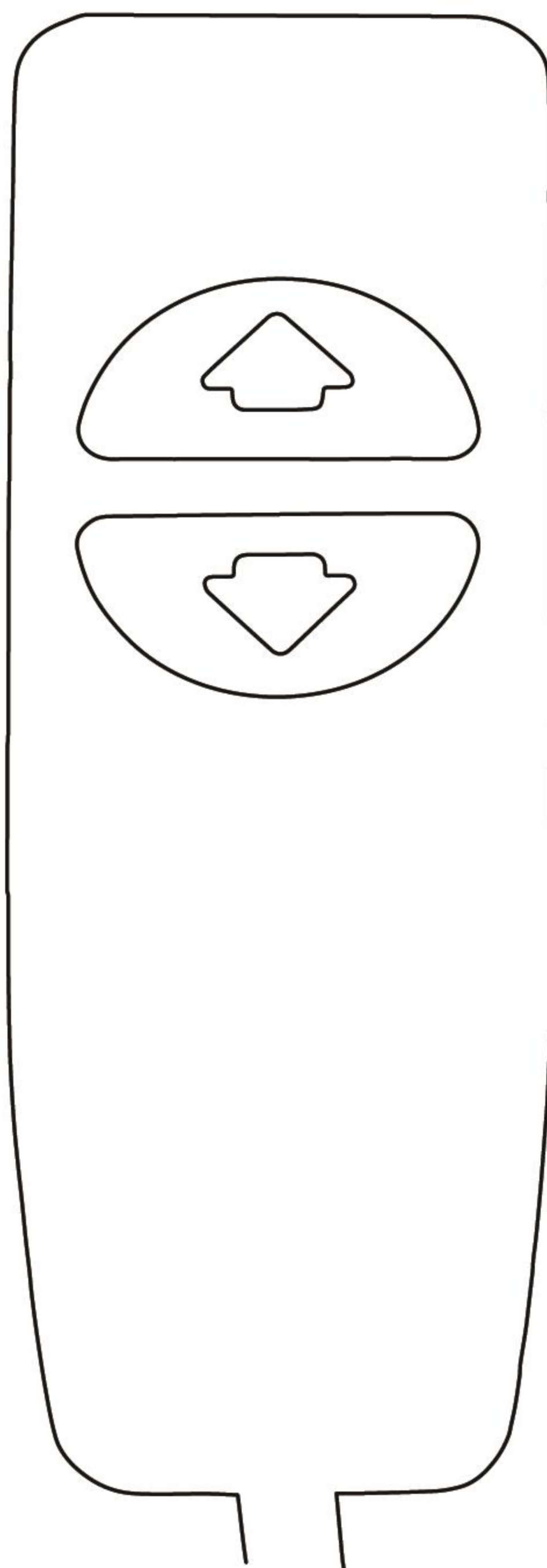





le dossier est droit, le pie position allongéed est abaissé (position assise) ;
maintenir la pression : incliner le canapé vers l'avant (aide à la verticalisation).

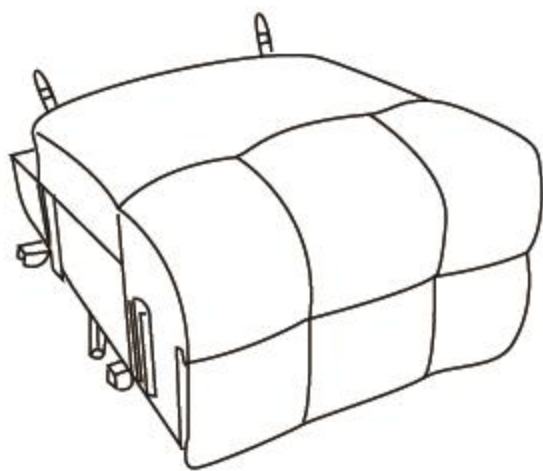
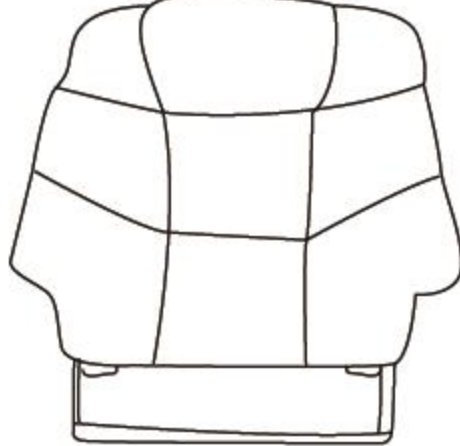
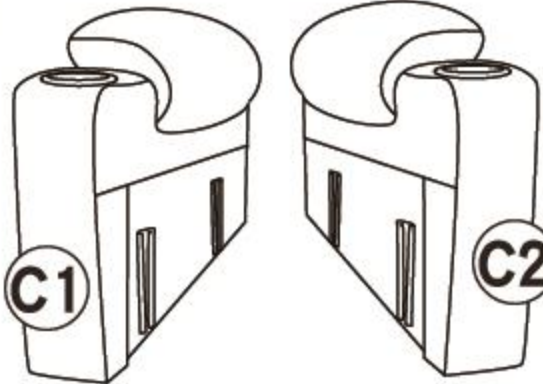
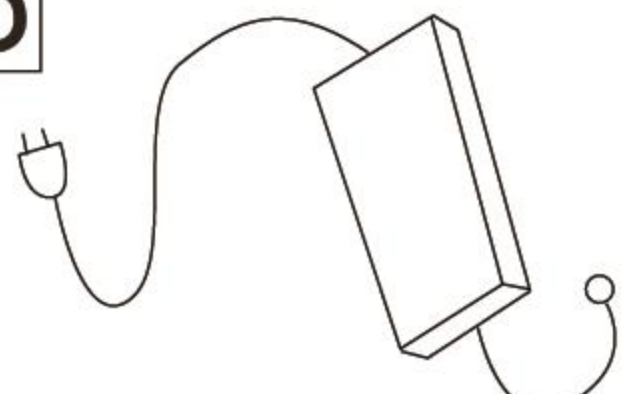

Déplacez le dossier vers le bas, la partie pieds vers le haut (position allongée).

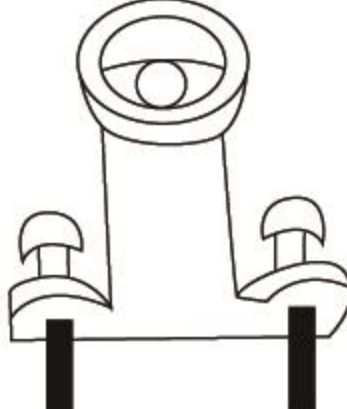
Sofa assembly instruction

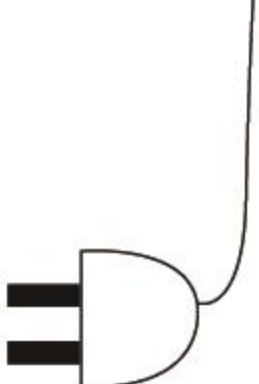
A  Base de la silla 1x	B  Respaldo 1x	C  Reposabrazos izquierdo y derecho 2x	D  Cable de alimentación 1x
E  Mando a distancia 1x	F  Parte1 2x	G  Parte2 4x	H  Conector de alimentación 1x

PASO 1

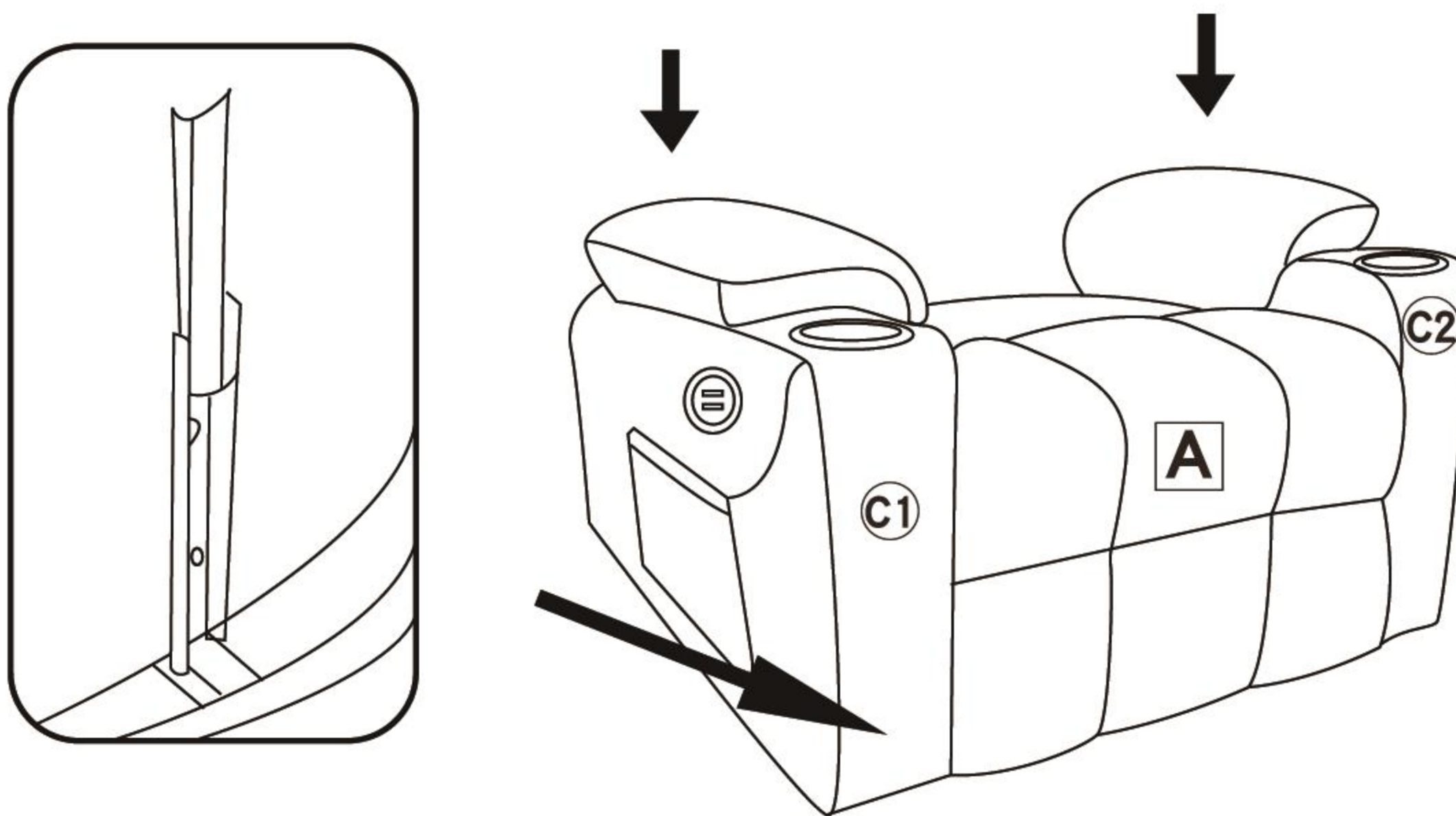

PASO 2

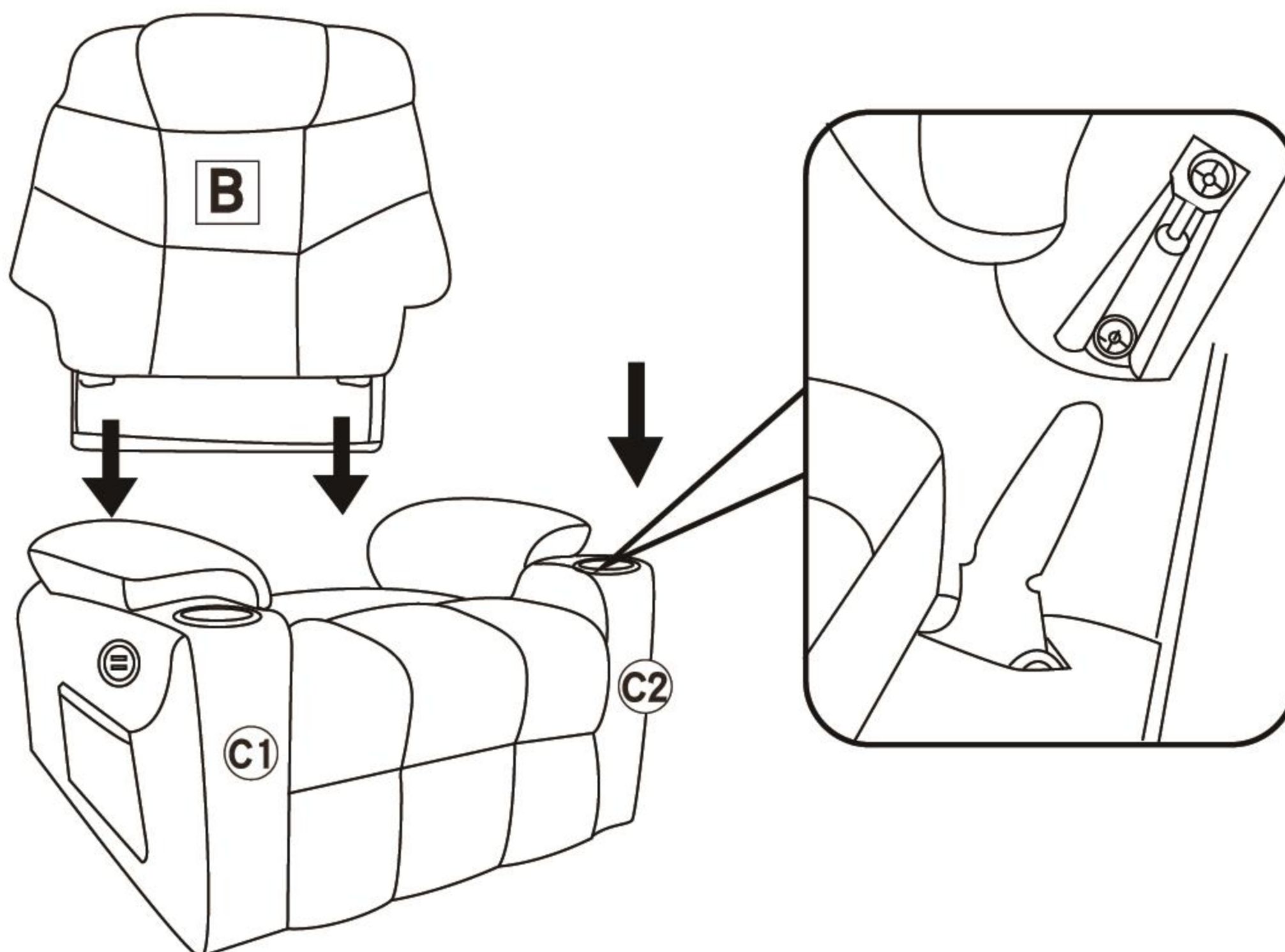

Sofa assembly instruction

PASO 3

La toma USB en la parte inferior del reposabrazos del sofá.

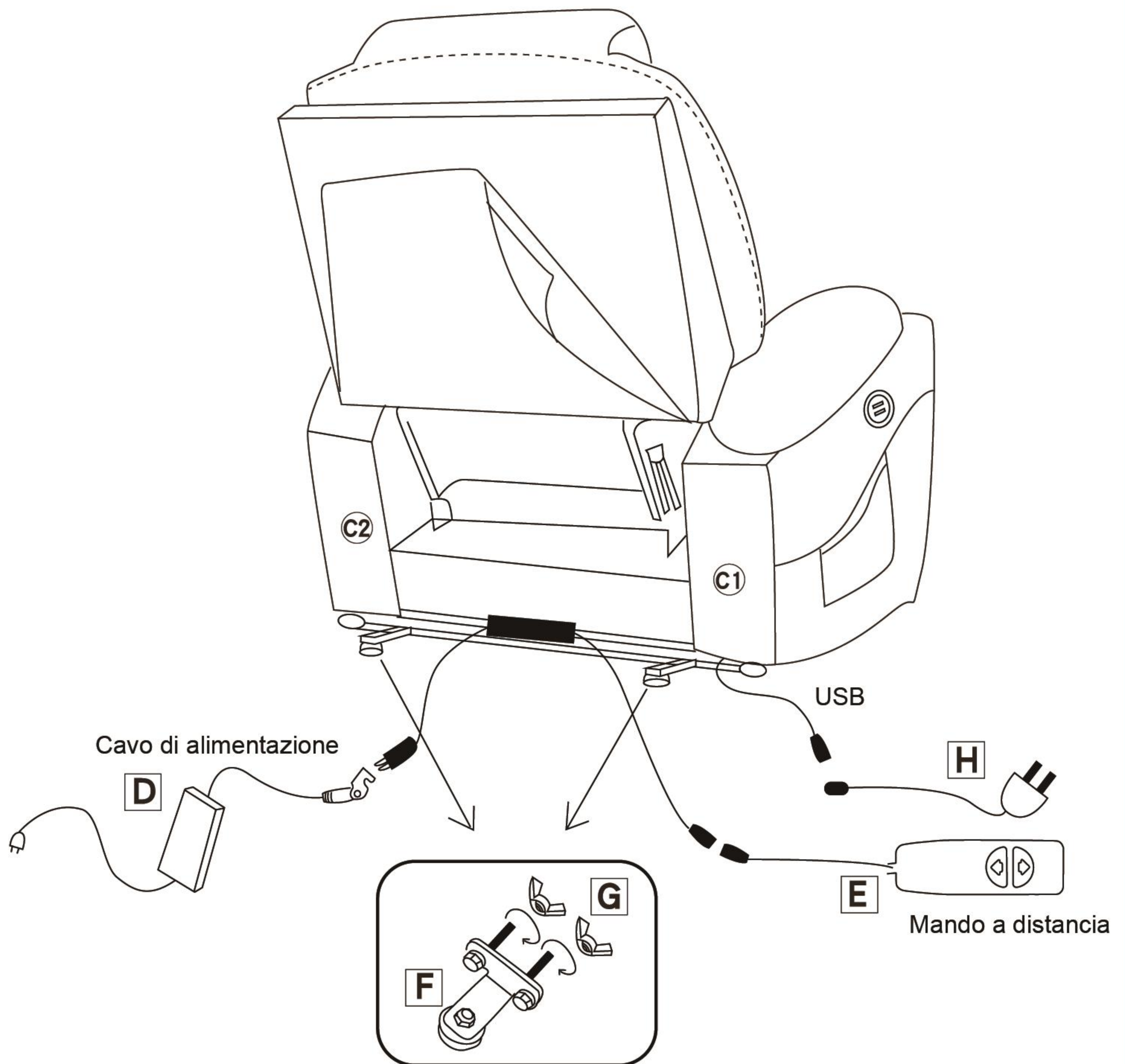

Sofa assembly instruction

¿Cómo revestir?

Presione

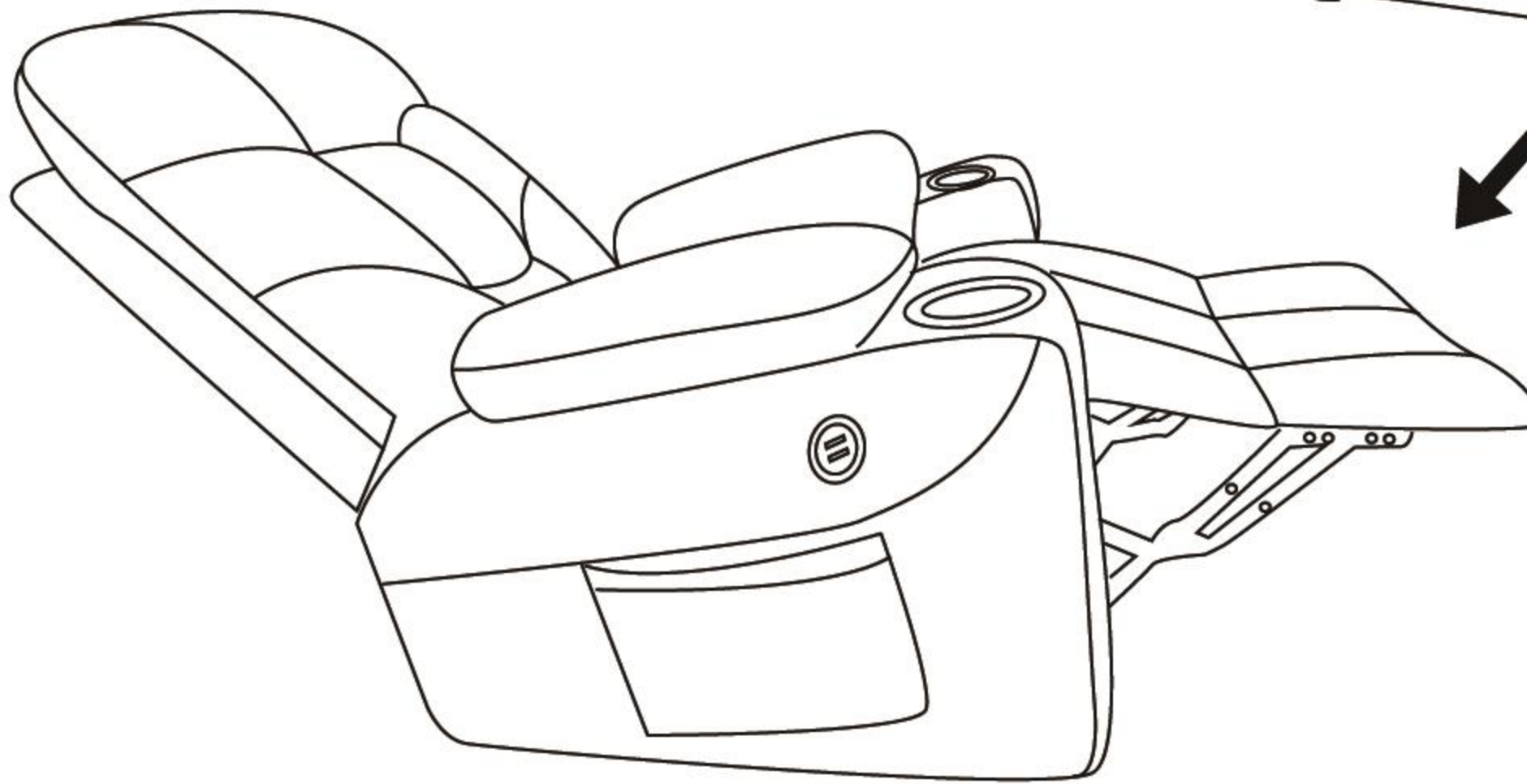
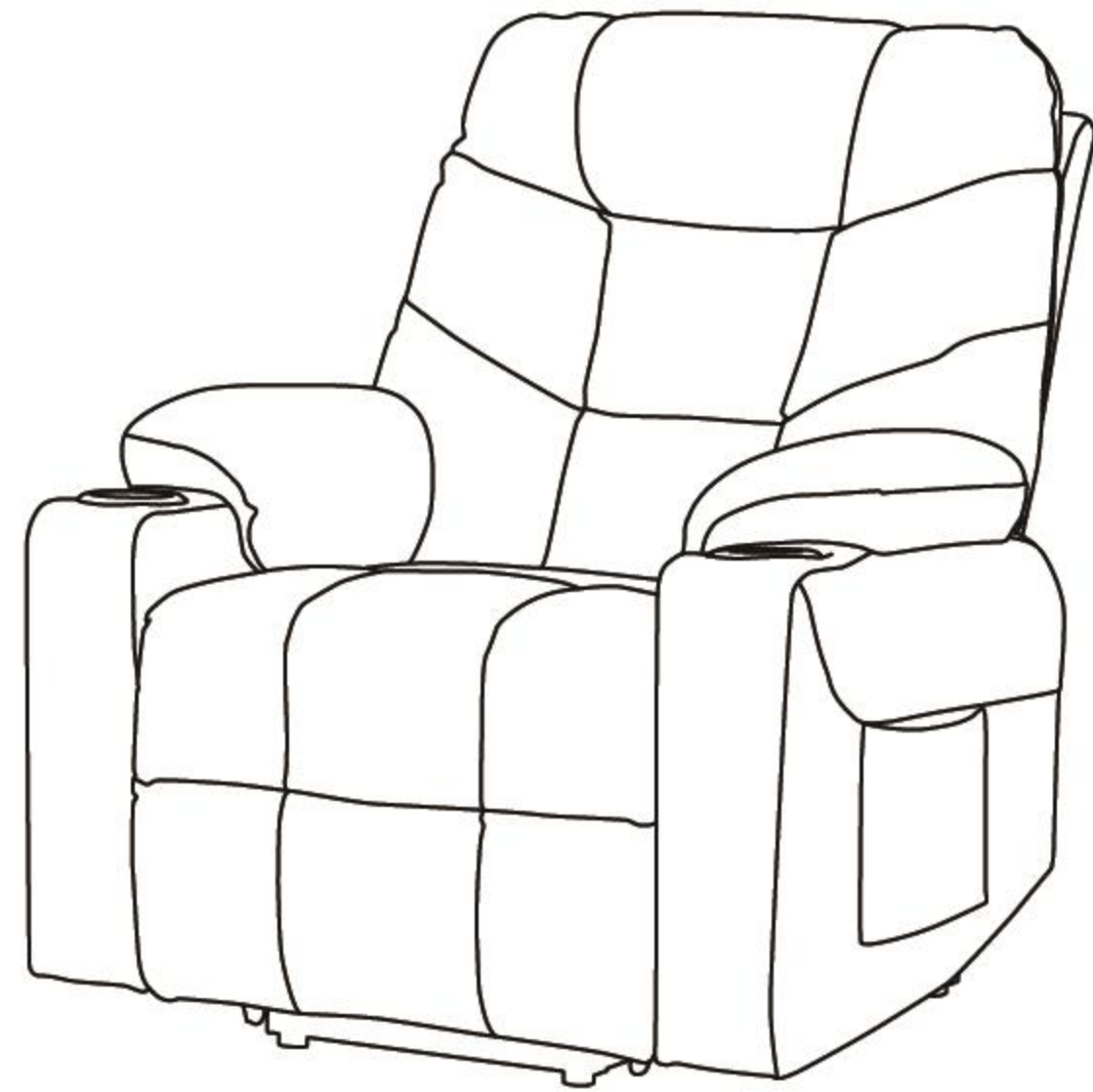
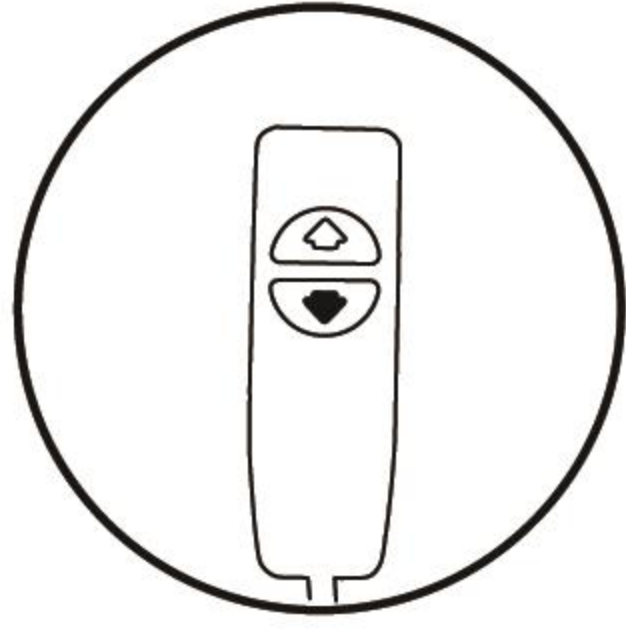

¿Cómo se puede conseguir que el reposapiés se enganche en un soporte?

Presione

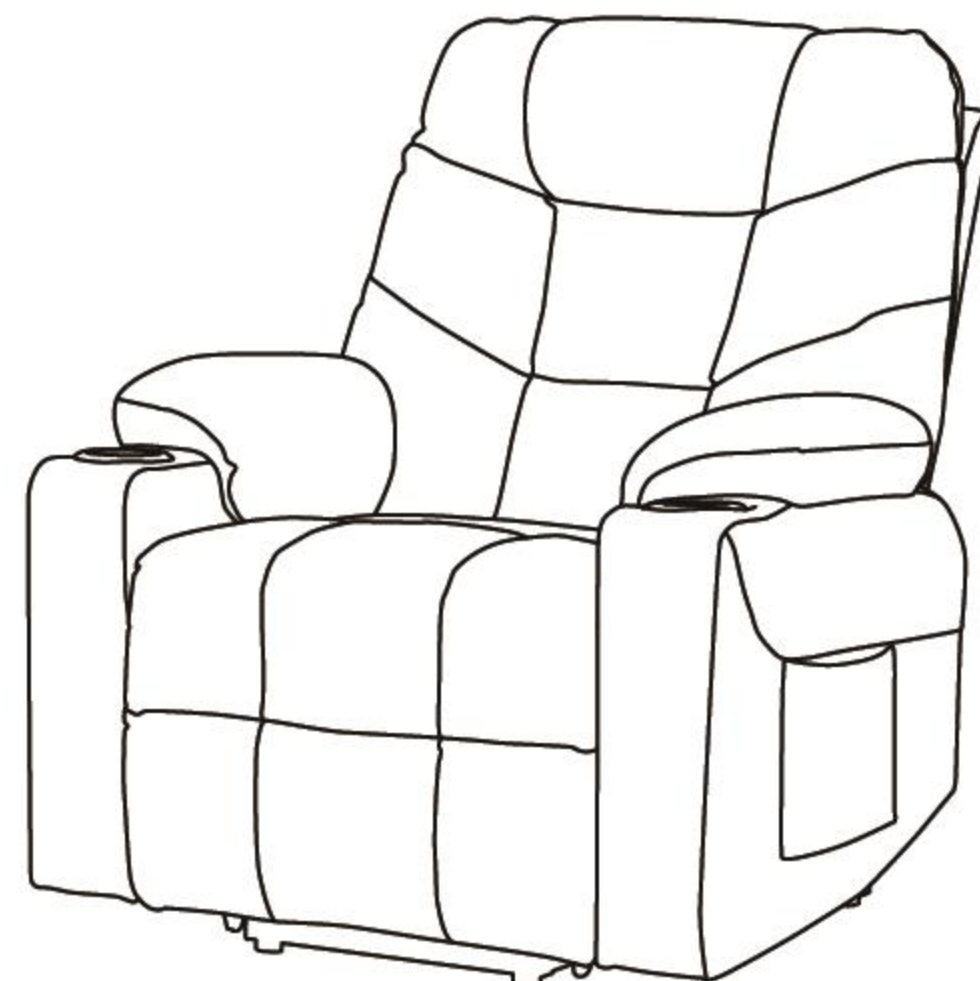
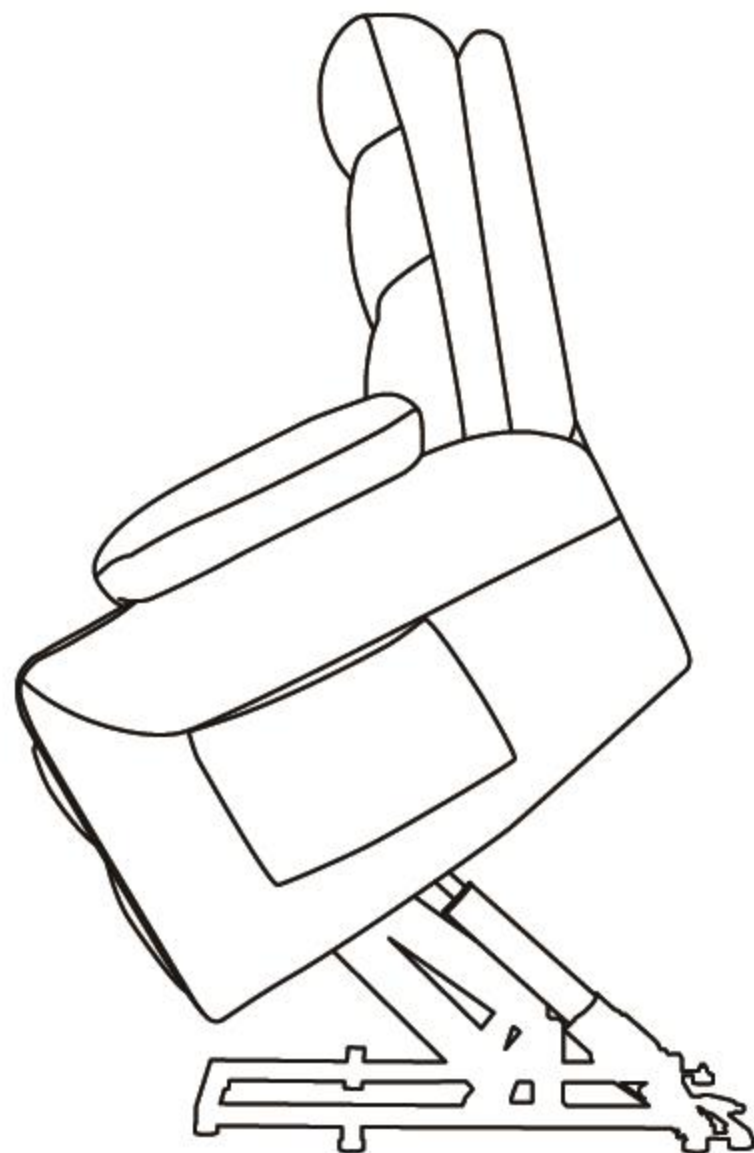
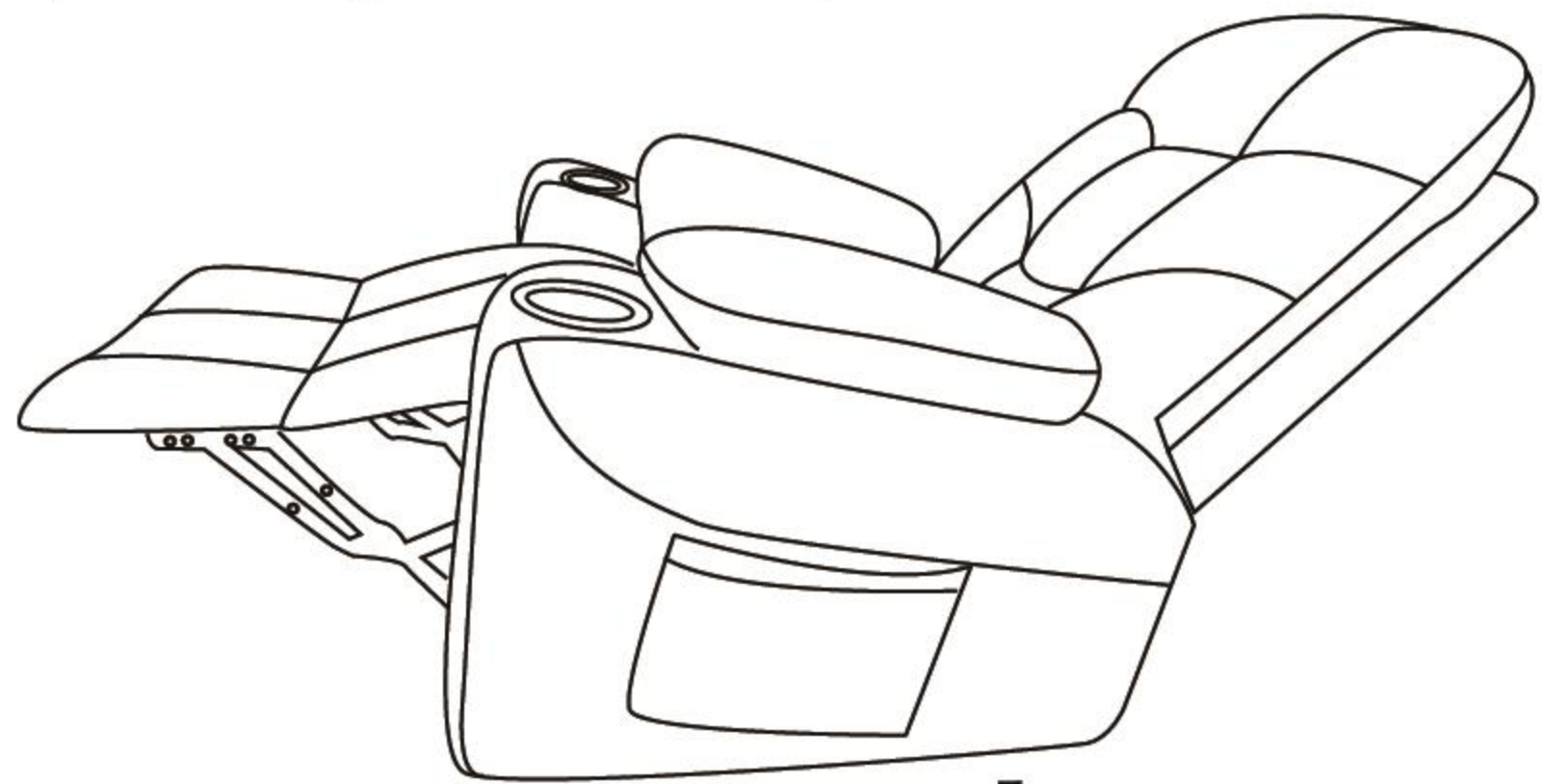
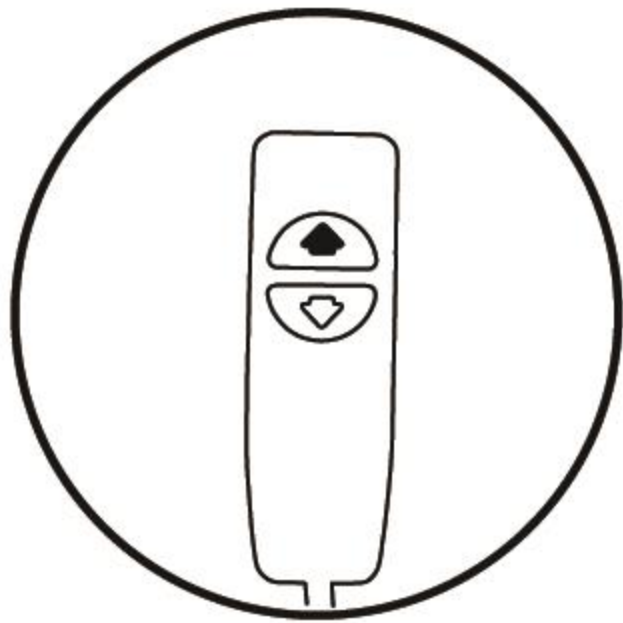

Sofa assembly instruction

¿Cómo se utiliza el mando a distancia del bipedestador?

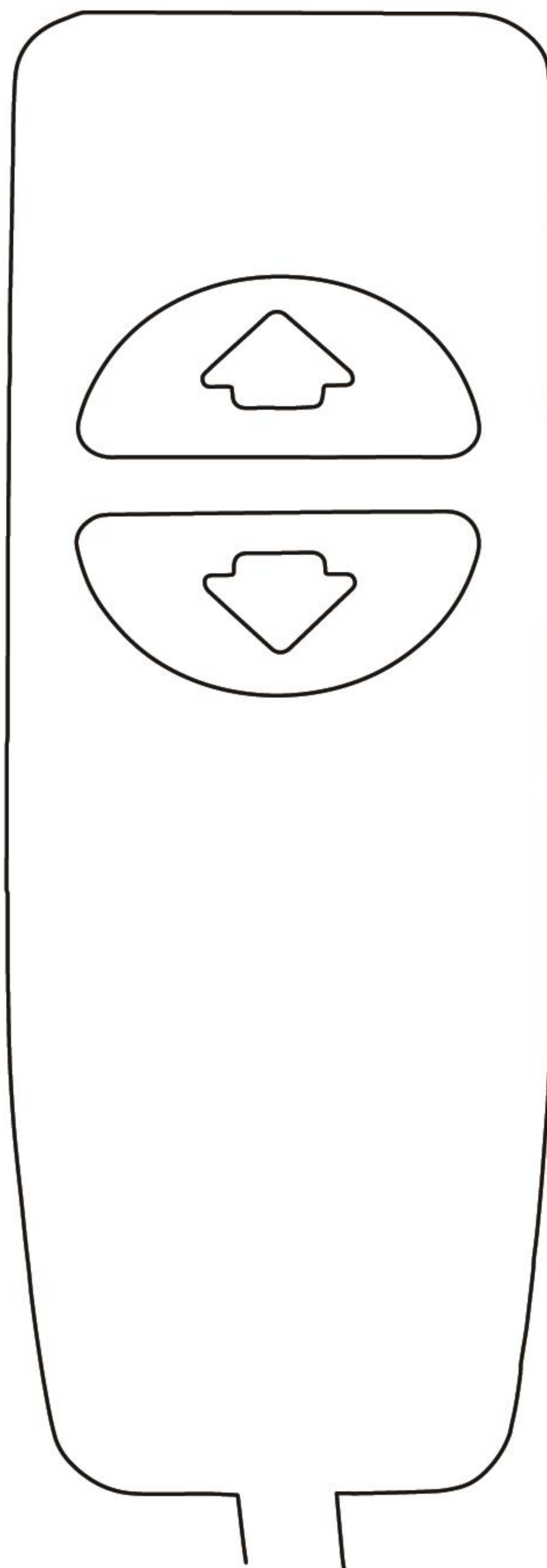



respaldo recto, sección de los pies hacia abajo (posición sentada);
seguir presionando: inclinar el sofá hacia delante (ayuda de pie).

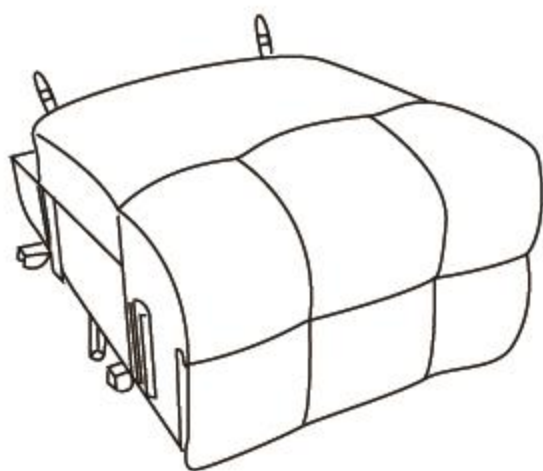
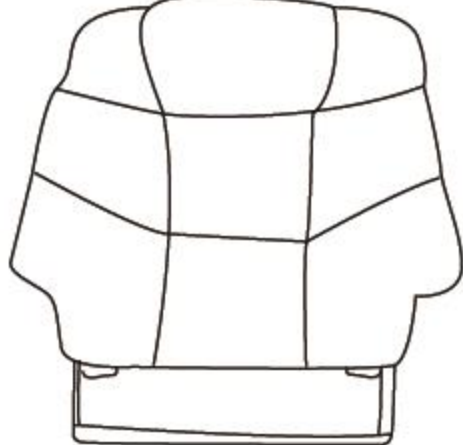
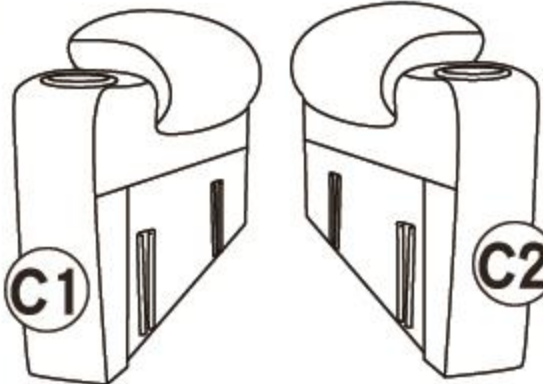
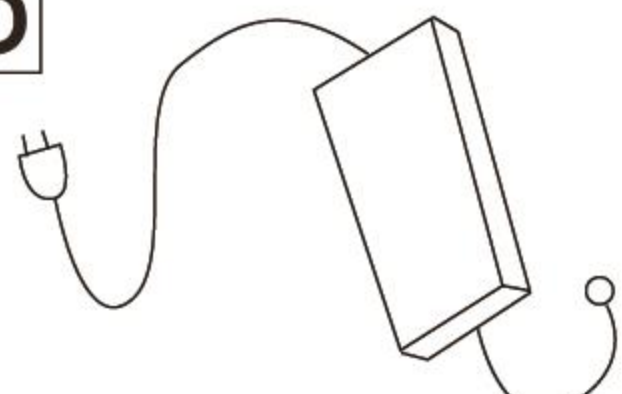

Mover el respaldo hacia abajo, la sección de los pies hacia arriba (posición acostada).

Sofa assembly instruction

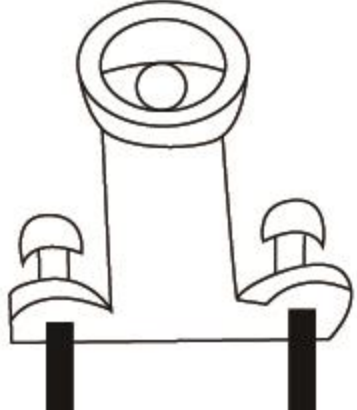
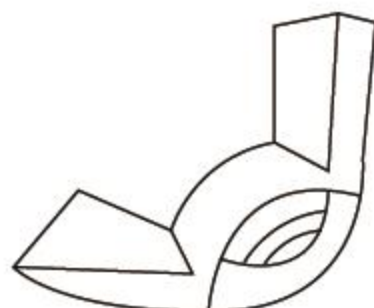
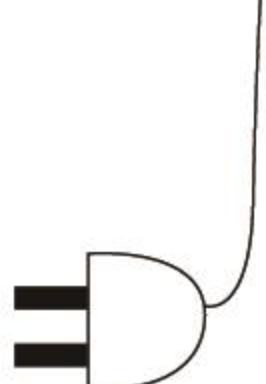
A  Base della sedia 1x	B  Schienaler 1x	C  bracciolo sinistro e destro 2x	D  Cavo di alimentazione 1x
E  Telecomando 1x	F  Parte1 2x	G  Parte2 4x	H  Connettore di alimentazione 1x

PASSO 1

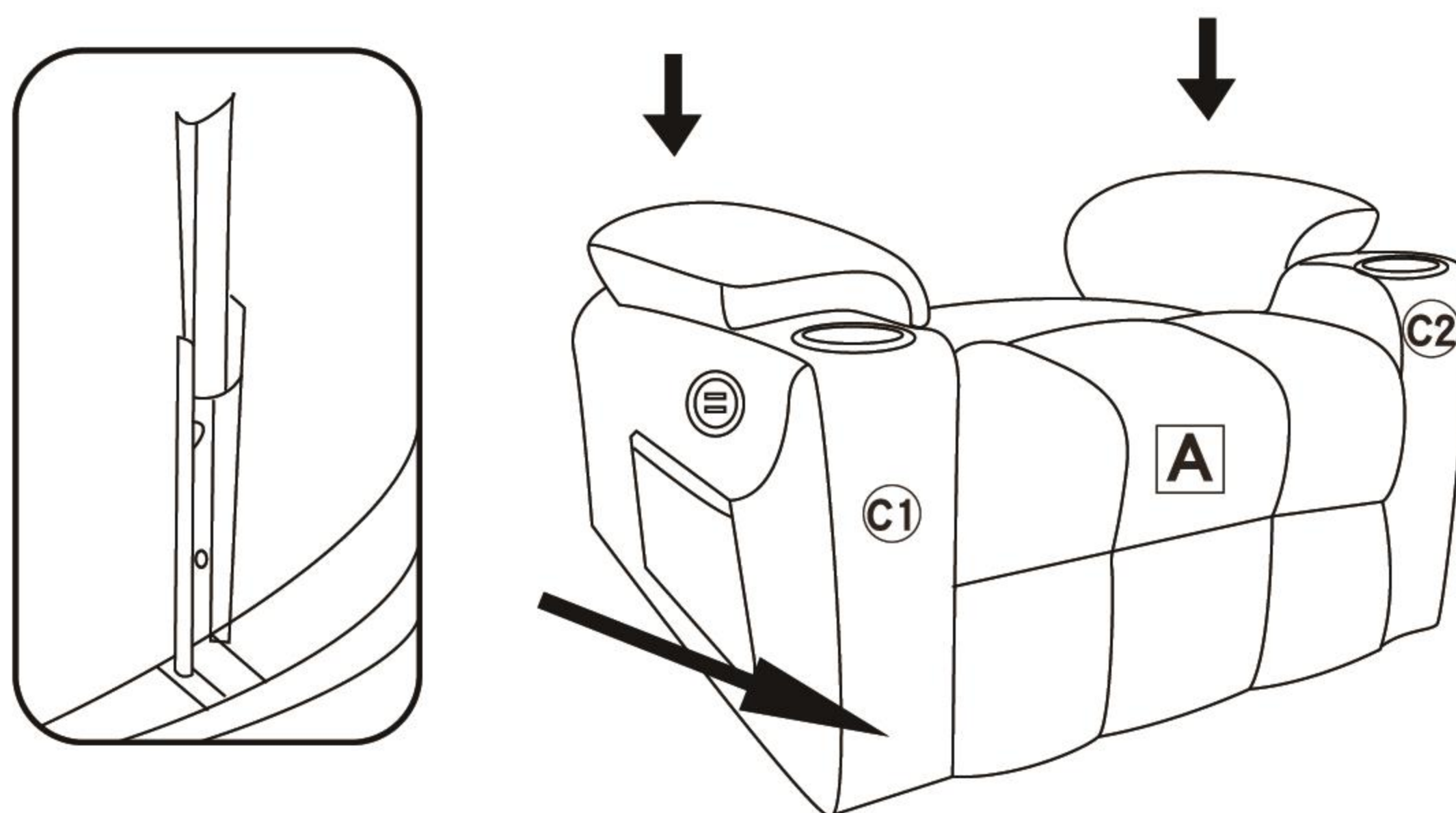

PASSO 2

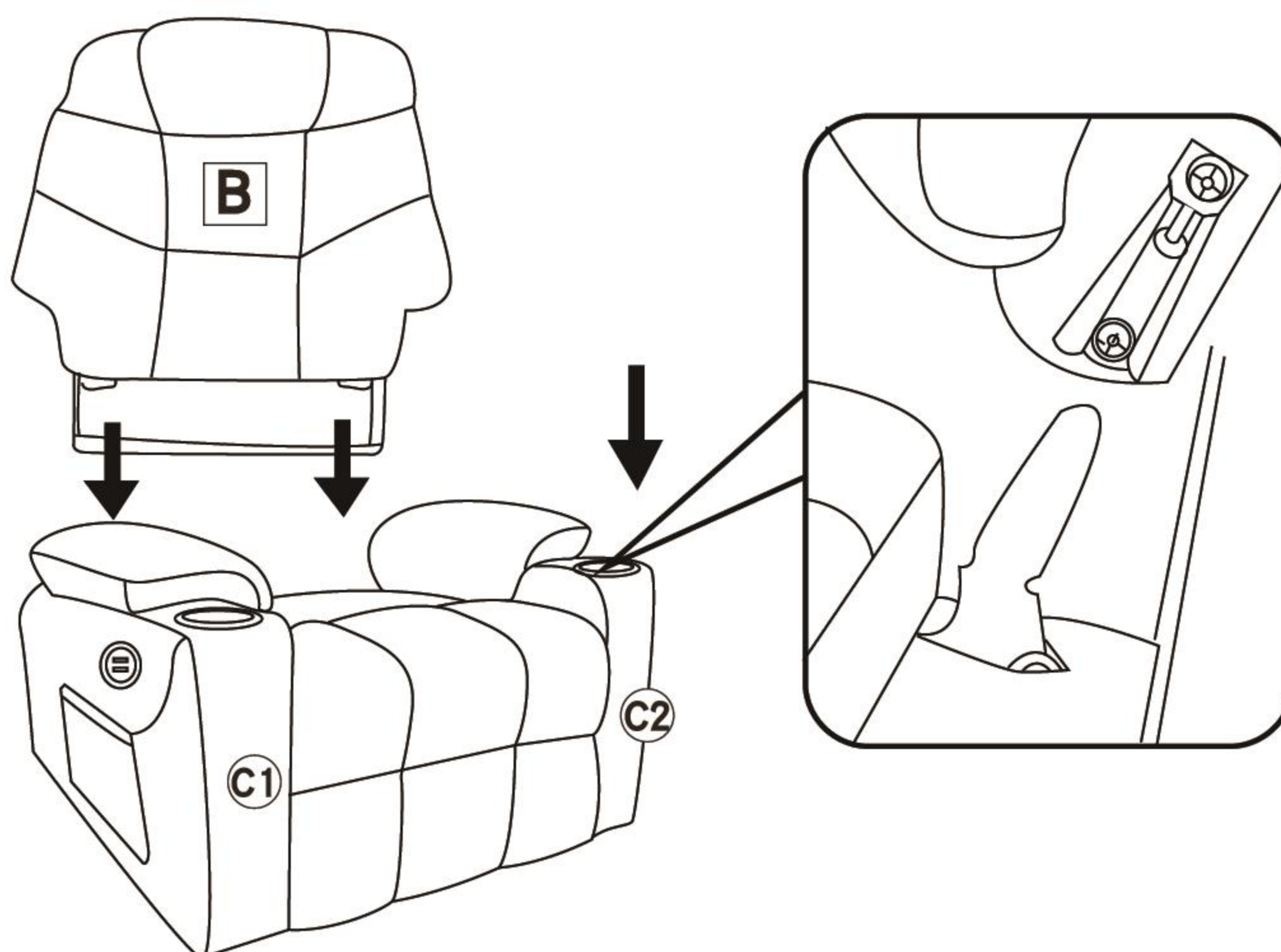

Sofa assembly instruction

PASSO 3

La presa USB nella parte inferiore del bracciolo del divano.

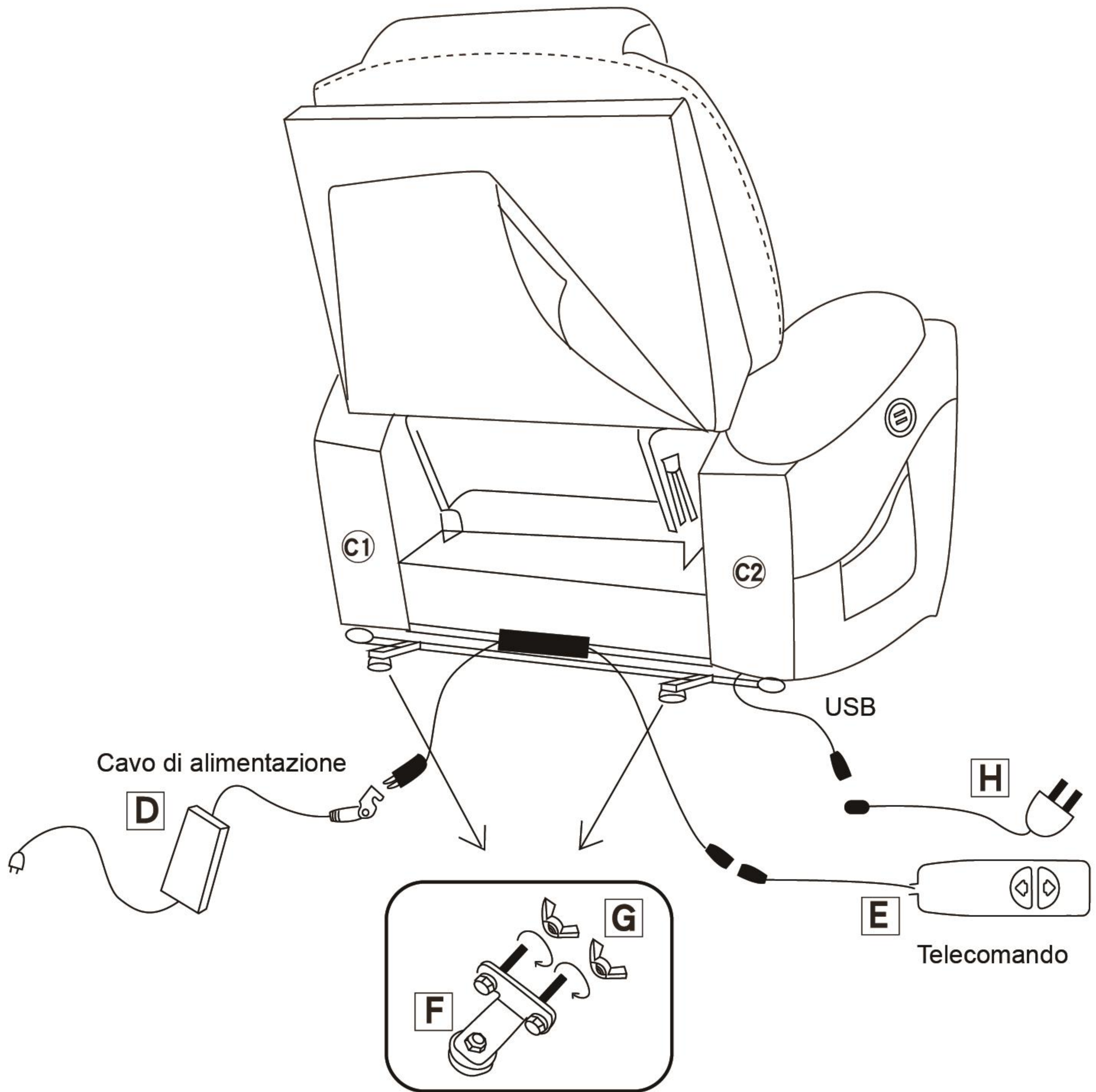

Sofa assembly instruction

Come riallinearsi?

Premere

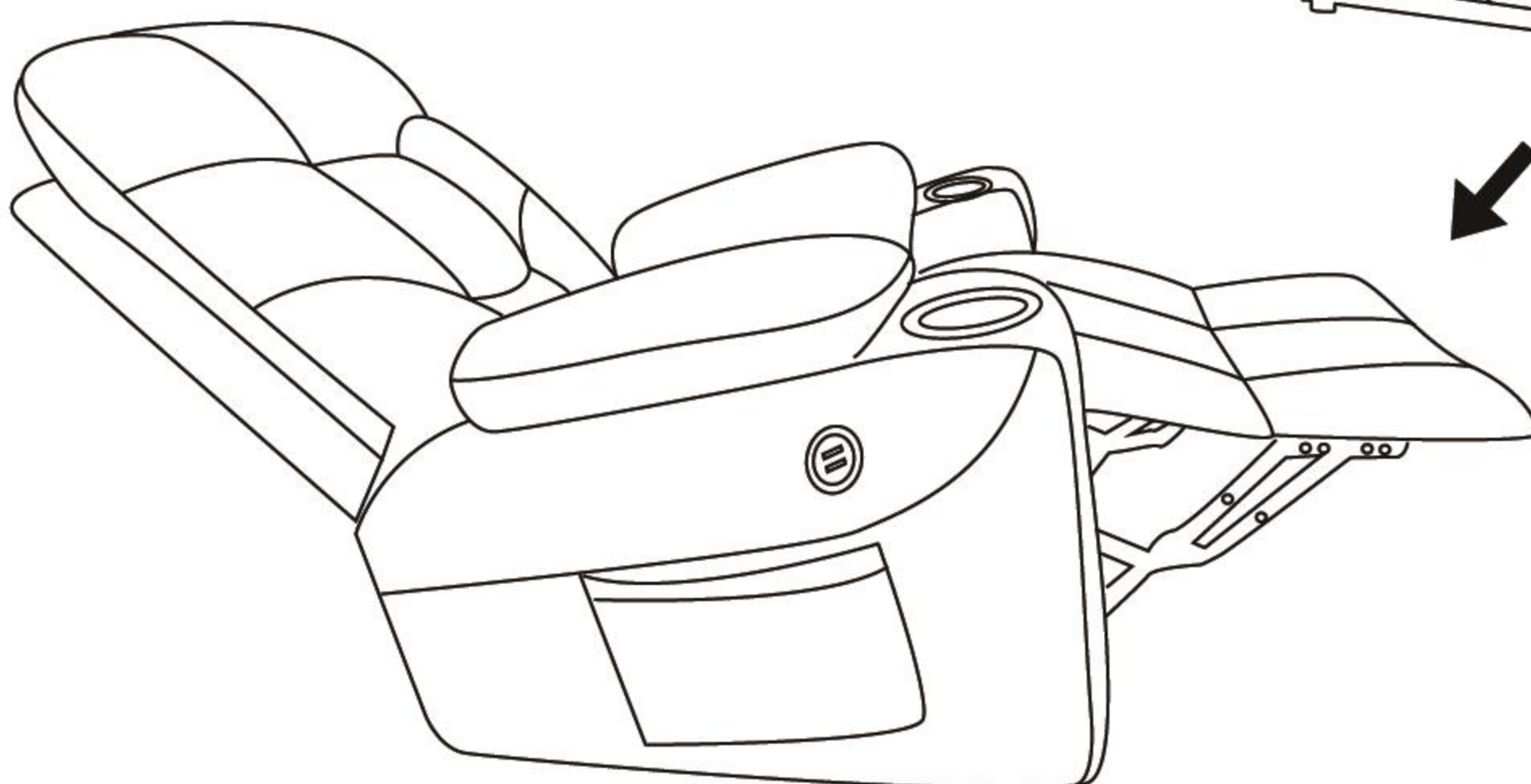
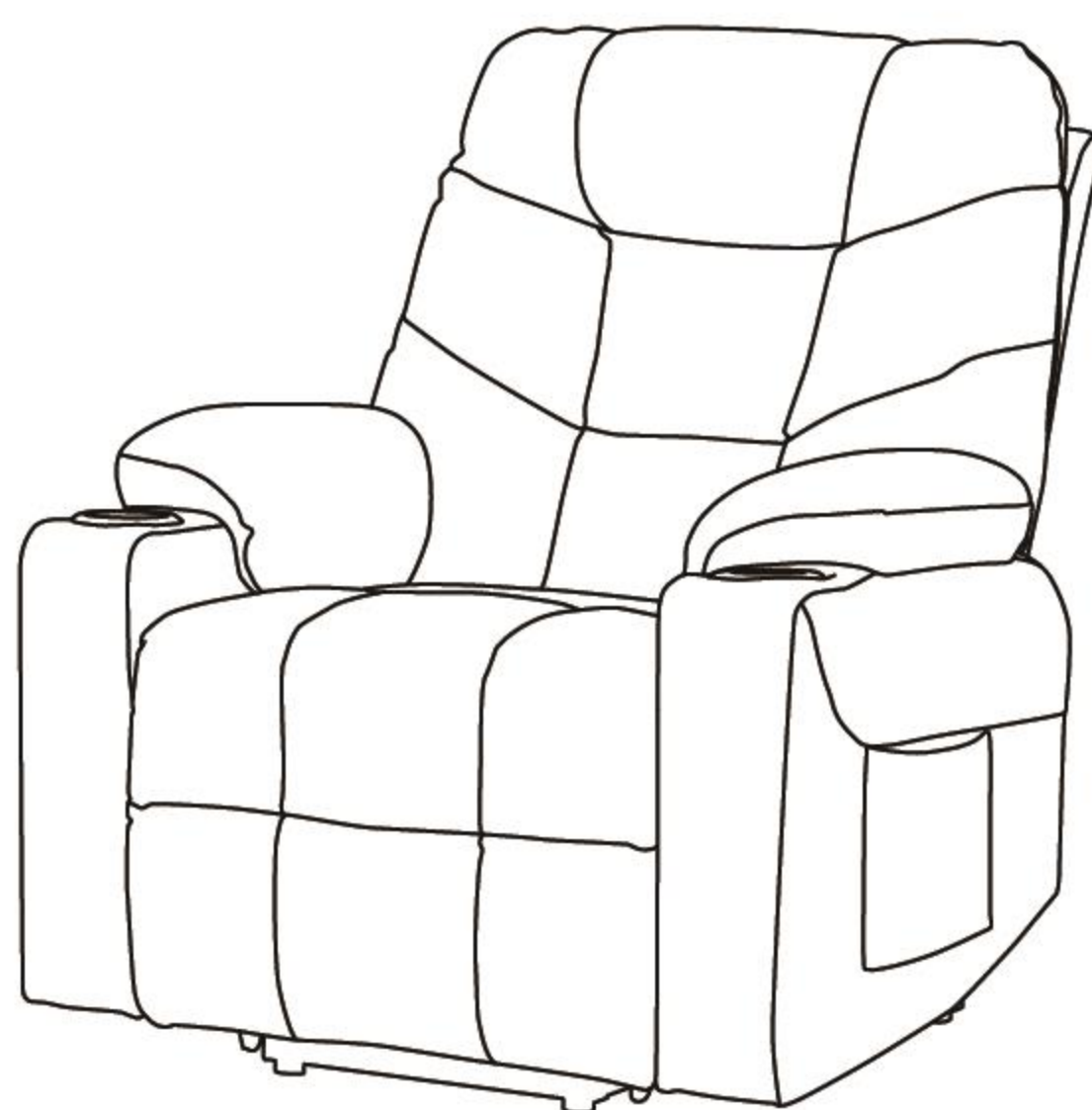
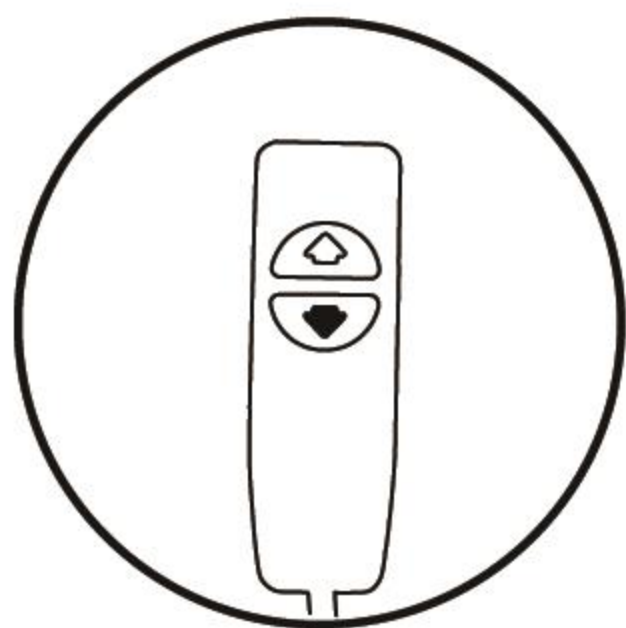

Come si fa ad agganciare il poggiatesta ad un supporto?

Premere

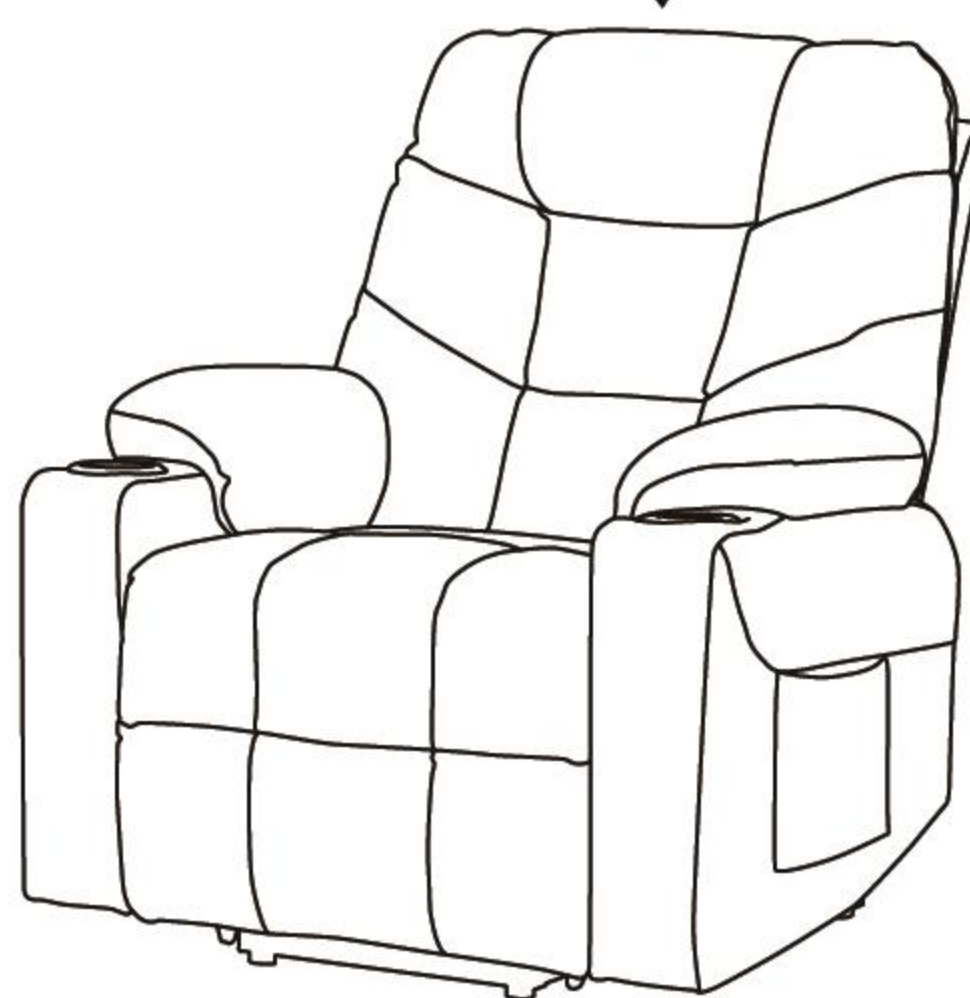
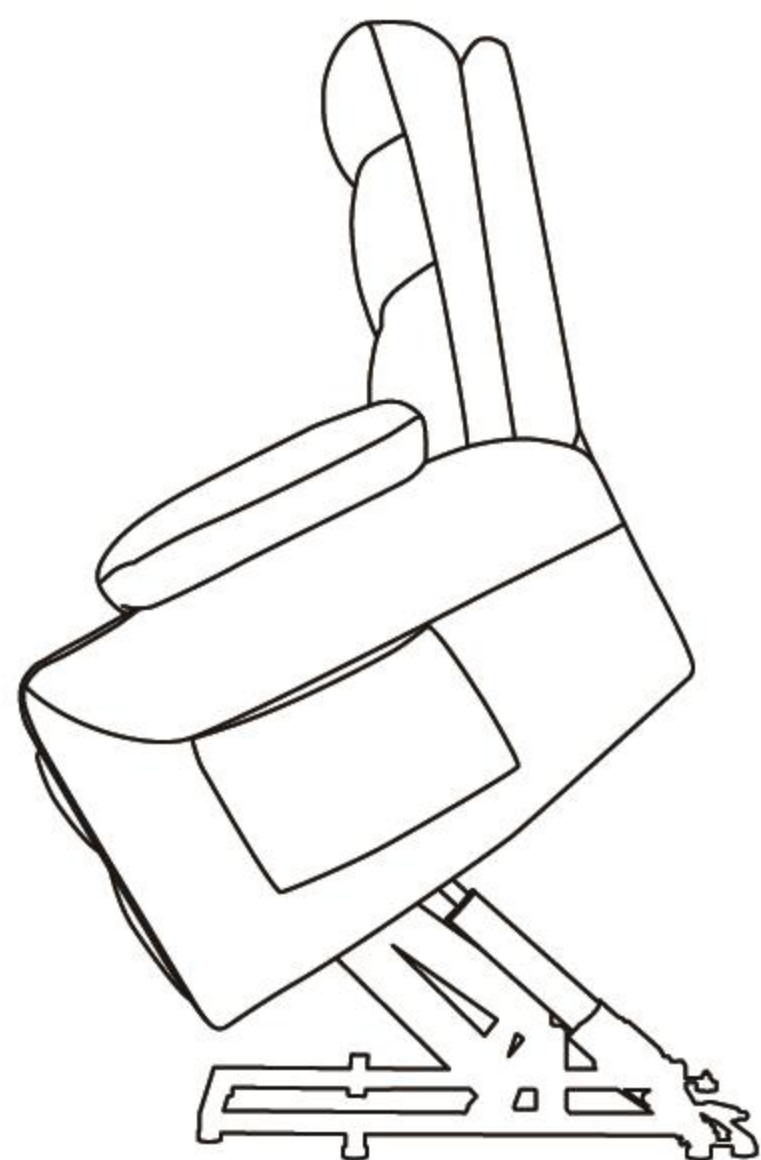
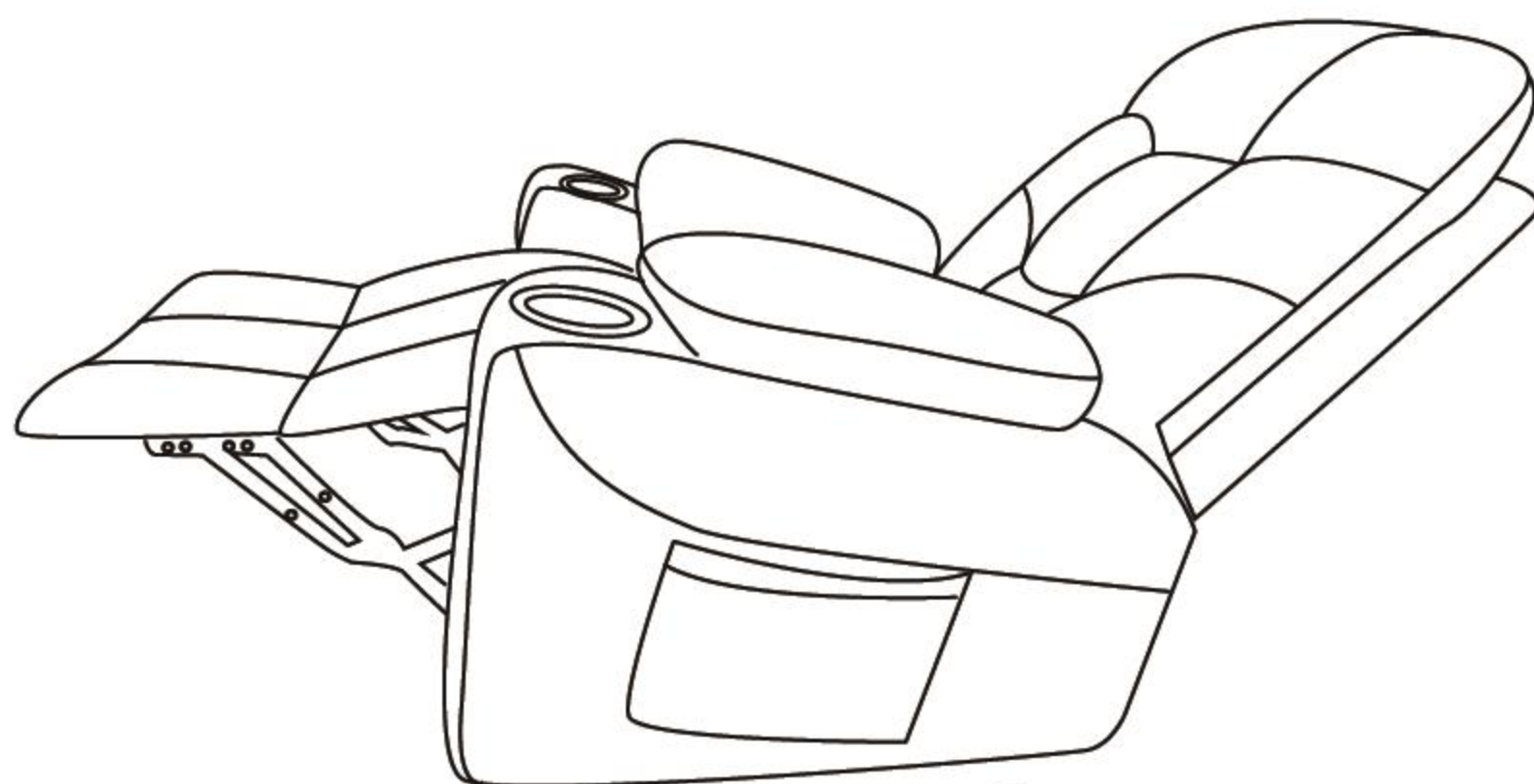
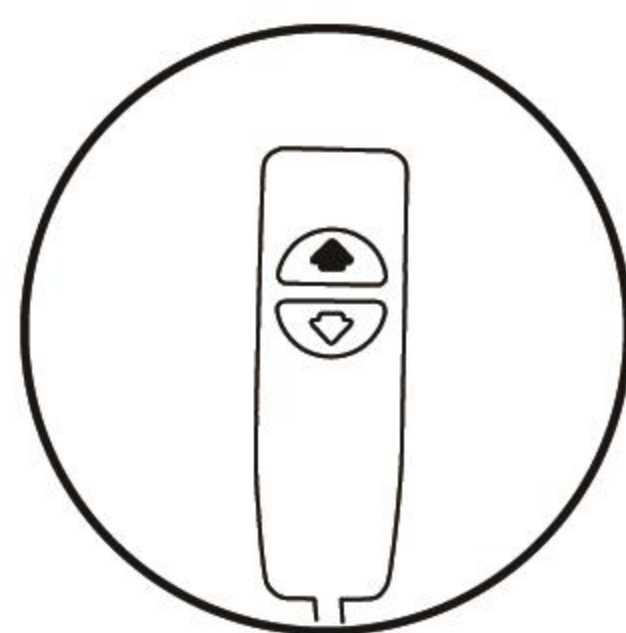

Sofa assembly instruction

Come si usa il telecomando per l'ausilio stand-up?

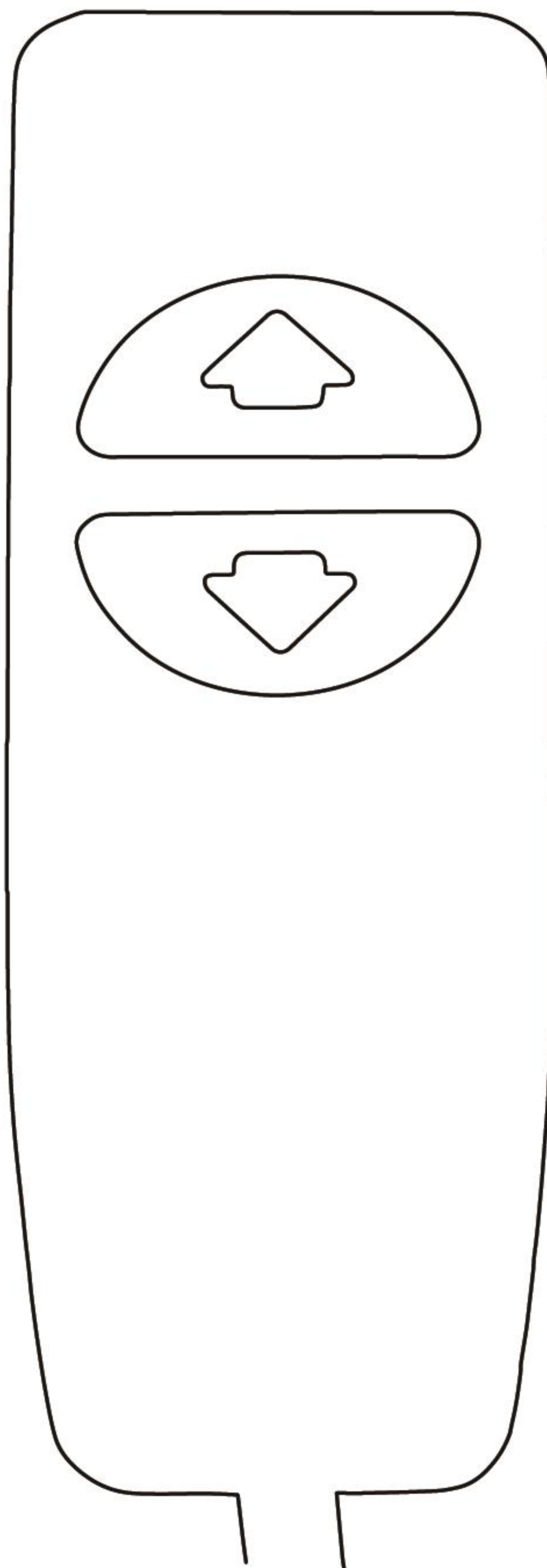

schienale dritto, parte dei piedi in basso (posizione seduta);
continuare a premere: inclinare il divano in avanti (ausilio per alzarsi in piedi).



Spostare lo schienale verso il basso, la sezione dei piedi verso l'alto (posizione sdraiata).



MCombo

Pfillo GmbH

Adresse: Kreuzweg 60, 47809 Krefeld

E-mail: pfillo.de@gmail.com