

LKZ: 80050

Modellname / Model name / Nom du modèle / Modellnamn / Nome modello / Název modelu / Modelnaam / Ime modela / Numéro Modelo / Modell neve / Название мо дела / Názov modelu / Ime modela / Denumire model / Наименование на мо дела / Nazwa modelu

Norris

Modellnummer / Number / Numéro du modèle / Numero / Номер на мо дела / modello / Číslo modelu / Modell száma / Éislo modelu / Stevilka modela / Număr model / Broj modela / Modelnummer / Numer modelu

2302.862.84

Type / Tipo / Típus / Тип / Тип / Tip

862

20.07.2023

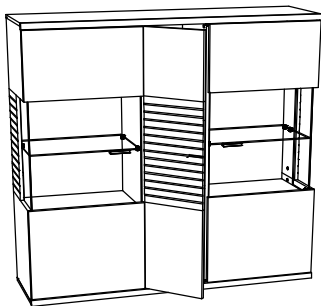
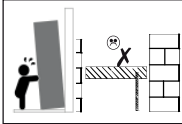
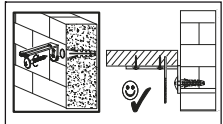
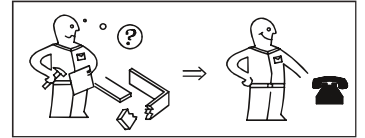
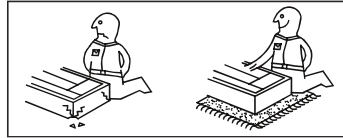
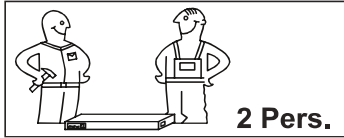

«L»

«R»

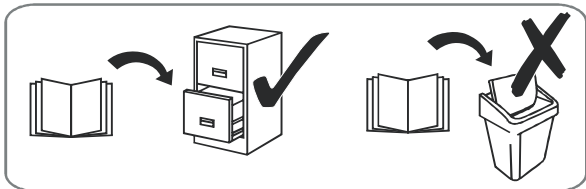
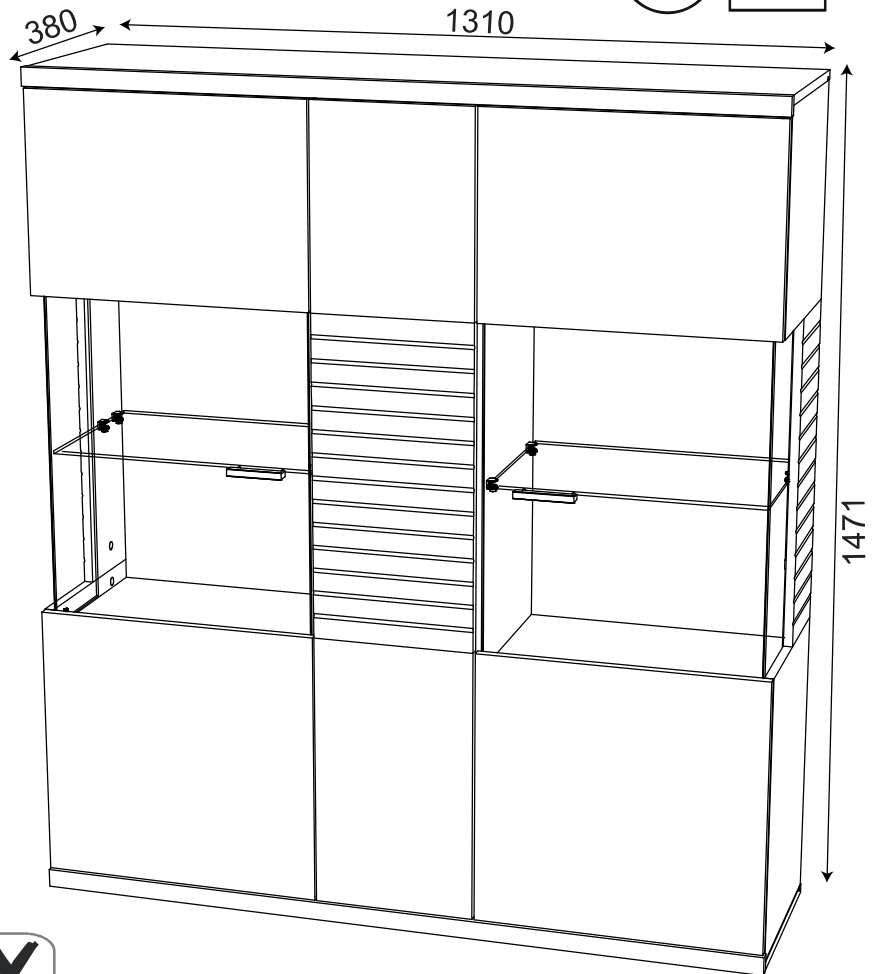
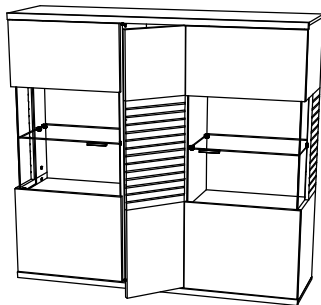

Wichtig - Für spätere Verwendung aufbewahren - sorgfältig lesen!

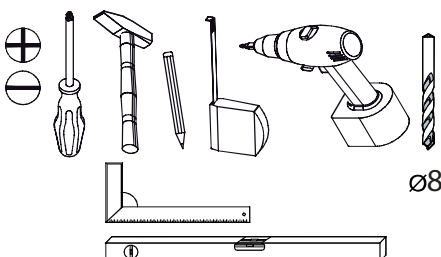

festziehen / tighten / За тегнети / serrer / stringere / utåhnut / vasttrekken / zategnuti / strângere / zwiázac / zacisnąć / szorosan meghúzni / pevne dotiahnut / trdno pritegniti / затянуть / dra át



eindrücken / press in / enfoncer / wcisn / ribattere / zatla čit / Вкарайте / indrukken / benyomni / stăcit / vtisniti / tryck in / introducere prin apăşare / вдавить



ausmessen / measure / mesurer / misurare / opmeten / izmeriti / miera / kiméni / izmeriti / măsurare / измерить / změřit / Измерете / mät upp / zmierzyc



drücken / press / presser / stisknout / Na tische te / vtisniti / nasinac / drukken / pritisnuti / nacisnac / pritisniti / нажаť / (meg)nyomni / apăşare / tryck fast / nacisnąć



einschlagen / hammer in / beverni / sla in / frapper au marteau / infossare / Zabit' / zarazit / Набийте / zabit' / wbić / introduce prin bătaie / забить / zatloact



Drehen - wenden / przekrećić - odwrócić / Keren - omdraaien / Girare - Ruotare / Okrenuti - ubrnuti / Retourner - renverser / Turn over - turn around / Otočte - obratite / Завъртете - обърнете / Obrnite list / întoarceţi - rotiţi / Vrid runt - vänd / прокрутить - повернуть / otočiti - obratiti / elforgatni - megfordítani

LKZ: 80050

Modellname / Model name / Nom du modèle / Modellnamn
Nome modello / Název modelu / Modelnaam / Ime modela
Numéro Modello / Modell neve / Название модели /
Názov modelu / Ime modela / Denumire model /
Наименование модели / Nazwa modelu

Norris

Modellnummer / Number / Numéro du modèle
Numero / Номер на модели / modello
Číslo modelu / Modell száma / Éíslo modelu
Številka modela / Număr model / Broj modela
Modellnummer / Numer modelu

2302.862.84

Type / Tipo / Tipus / Typ / Тип / Tip

862

D Unser Direktservice für Beschlagteile
Sollte Ihnen ein Beschlagteil fehlen, können Sie diese Servicekarte direkt an die untenstehende Adresse mailen. Wir können allerdings nur Beschlagteile auf diesem Wege verschicken. Sollten Sie eine andere Beanstandung an Ihrem Möbelstück haben, so wenden Sie sich bitte direkt an Ihr Möbelhaus.

GB Our direct order service for fitting
If a fitting part is missing, you can e-mail this service card directly to the address below. However, we can only send fitting parts in this way. If you have any other cause for complaint concerning your item of furniture, please contact your furniture store directly.

CZ Naše přímé služby pro kování
Chybí-li vám nějaký díl z kování, můžete tuto servisní kartu odeslat e-mailem přímo na níže uvedenou adresu. Touto cestou však může me zoslat jen díly kování. Pokud byste reklamovali jiný díl nábytku, obraťte se přímo na svého prodejce nábytku.

F Bien étudier la notice de montage
S'il vous manque une ferrure, veuillez envoyer directement la présente carte service à l'adresse e-mail indiquée ci-dessous. Cependant, ceci nous permet uniquement d'envoyer des ferrures. Pour tout autre type de réclamation concernant votre meuble, veuillez contacter directement votre magasin d'ameublement.

I Il nostro servizio diretto per l'ordine della ferramenta
Qualora V. i dovesse mancare un pezzo di fissaggio, allora V. i preghiamo di inviare questa carta di servizio immediatamente all'indirizzo sottostante. Possiamo inviare i pezzi di fissaggio solamente per mezzo di questo procedimento. Qualora dovete avere qualche altra reclamazione in merito al mobile, allora V. i preghiamo di rivolgerV. i direttamente alV. osto Negozio di mobili.

BG Наша та директна услуга за обкова
Ако липне в частини от комплекта, попълнете тази карта за директна услуга за обкова на е-мил адреса, посочен по-долу. По този начин можем да доставим само липсващи елементи от обкова. Ако установите друг дефект по мебелите, Ви съветваме да се обвържете към мебелната къща/магазин, от който сте закупили мебелта.

NL Onze directservice voor losse onderdelen
Wanneer er een onderdeel ontbreekt, kunt u deze servicekaart direct aan onderstaand e-mailadres sturen. Wij kunnen losse deze weg echter alleen beslagdelen versturen. Mocht u een ander probleem aan uw meubel hebben, verzoek u in contact op te nemen met uw meubeldealer.

PL Nasz bezpośredni serwis części montażowych
Jeżeli brakuje części koniecznych do montażu, prosimy o przesłanie nam niniejszej karty serwisowej na niżej podany adres e-mailowy. W ten sposób możemy przesać Państwu tylko brakujące części. W przypadku innych reklamacji dotyczących mebla, prosimy zgłosić się do salonu meblowego, w którym został dokonany zakup.

HR Servis za okove
U slučaju da nedostaje neki od dijelova molimo vas da na dolje navedenu mail adresu pošaljete ovaj servisni obrazac. Na ovaj način mogu se dostaviti samo okovi. U slučaju da imate dodatne prigovore vezane uz komad namještaja molimo vas da se obratite izravno trgovini namještaja gdje je isti kupljen.

HU Direkt szolgáltatunk vasalatok esetén
Ha hiányzik egy vasalat, ezt a kártyát közvetlenül elküldheti az alább található címre. Azonban csak vasalatok tudunk így küldeni. Amennyiben másfajta reklamációt állít fel, kérjük forduljon közvetlenül a bútortárházhoz.

SK Náš priamy servis pre časti kovania
Ak by Vám chýbala nejaká časť kovania, môžete poslať túto servisnú kartu pošou e-mailom na nižšie uvedenú adresu. Dieľo kovania vieme poslať iba týmto spôsobom. Ak by ste mali inú reklamáciu ohľadom Vašho nábytku, obráťte sa priamo na Vašu predajňu nábytku.

SLO Naše direktno uslužne storitve za okovje
Če vam manjka kakšno okovje, lahko to servisno kartico pošljete po e-pošti direktno na spodnji naslov. Po tej poti vam lahko pošljemo samo okovje. Če želite reklamirati kakšen drug del pohištva, se obrnite neposredno na vašo trgovino pohištva.

RO Service-ul nostru direct pentru feronerie
În cazul în care vă lipsește o piesă de feronerie puteți să trimiteți direct acest card de service prin e-mail la adresa de mai jos. Noi nu putem expedia piese de feronerie decât pe această cale. Dacă aveți o altă reclamație referitoare la piesa de mobilier atunci vă rugăm să vă adresați direct la magazinul dvs. de mobilier.

RUS Наш прямой сервис для пост-авок фурнитуры
Если окажется, что у Вас не хватает того или иного элемента фурнитуры, Вы можете отправить сервисную карту по факсу непосредственно на нижеприведенный электронный адрес. Однако, таким образом мы можем переслать только фурнитуру. Если же у Вас возникнут иные претензии относительно приобретенной мебели, пожалуйста, обращайтесь непосредственно в организацию, откуда Вы приобрели мебель.

S Vår direktservice för beslagsdelar
Om du saknar en beslagsdel kan du skicka detta servicekort direkt till e-postadressen som anges nedan. Tank på att detta är den enda möjligheten att skicka beslagsdelar till dig. Om du vill reklamera din möbel av en annan anledning måste du kontakta ditt möbelhus direkt.

ES Nuestro servicio directo para accesorios
Si le falta algún accesorio, puede enviar esta tarjeta de servicio directamente a la siguiente dirección. No obstante, por este método solo podemos enviar accesorios. Si tiene alguna otra objeción sobre su mueble, consulte directamente con su mueblería.

TR Donatılar için doğrudan servisimiz
Bir donatınız eksikse bu servis kartını doğrudan aşağıda bulunan adrese doğrudan mail yazabilirsiniz. Sadece bu yolla donatılar gönderilebilir. Mobilyanızda başka şikayetleriniz varsa lütfen doğrudan mobilya satıcınıza danışın.

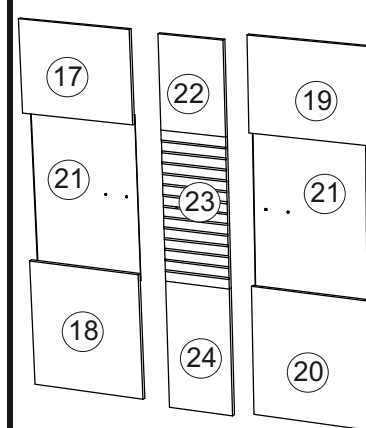
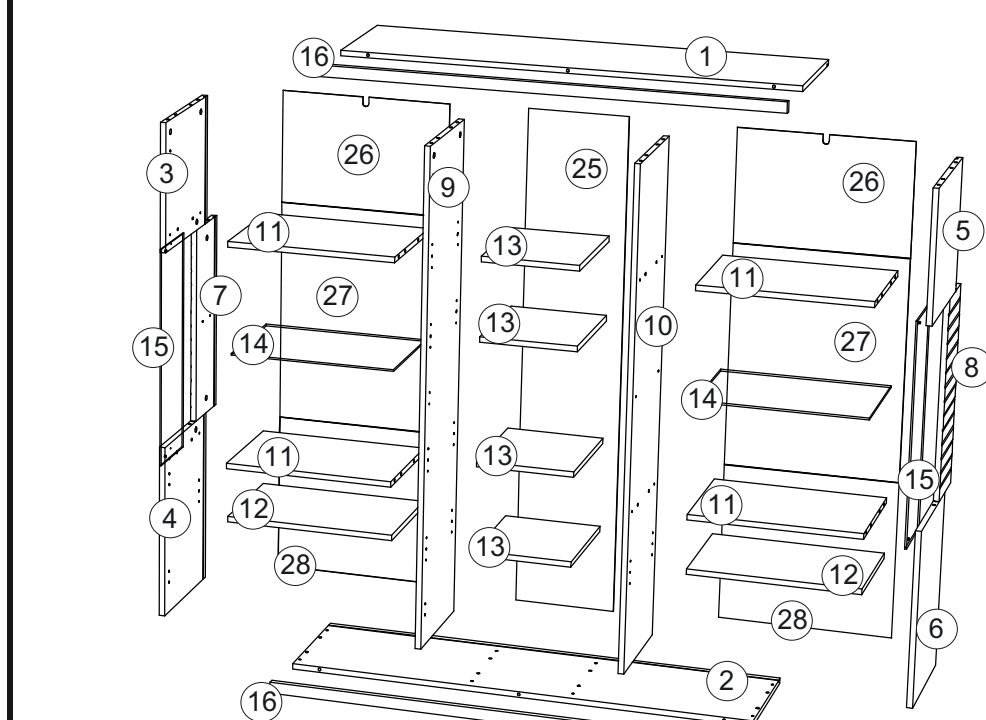

Nr.	Maße mm	Colli	Anzahl
1	1310 352	16	2/3 1
2	1310 352	16	2/3 1
3	368 352	16	2/3 1
4	496 352	16	2/3 1
5	368 352	16	2/3 1
6	496 352	16	2/3 1
7	560 176	16	2/3 1
8	560 176	16	2/3 1
9	1424 332	16	3/3 1
10	1424 332	16	3/3 1
11	486 332	16	1/3 4
12	486 322	16	1/3 2
13	272 322	16	1/3 4
14	477 317	5	3/3 2

Nr.	Maße mm	Colli	Anzahl
15	620 185	4	3/3 2
16	1311 32	18	2/3 2
17	350 507	16	1/3 1
18	477 507	16	1/3 1
19	350 507	16	1/3 1
20	477 507	16	1/3 1
21	620 482	4	3/3 2
22	350 285	16	2/3 1
23	560 285	16	2/3 1
24	477 285	16	2/3 1
25	1434 286	3	3/3 1
26	329 498	3	3/3 2
27	645 498	3	3/3 2
28	457 498	3	3/3 2
B1		1/3	1

Grund der Beanstandung / Cause for complaint: _____

Möbelhaus / Furniture store: _____

Kunde / Customer: _____ Telefon / Telephone: _____

PLZ / Postcode: _____ Ort / City: _____

Str.+Nr. / Street address _____

@E-Mail: _____

LKZ: 80050

Modellname / Model name / Nom du modèle / Modellnamn
Nome modello / Název modelu / Modelnaam / Ime modela
Numéro Modello / Modell neve / Название модели /
Názov modelu / Ime modela / Denumire model /
Наименование на модели / Nazwa modelu

Norris











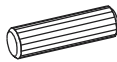
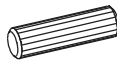

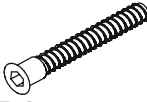
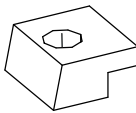
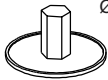
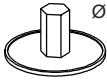



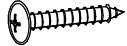

Modellnummer / Number / Numéro du modèle
Numero / Номер на модели / modello
Číslo modelu / Modell száma / Ěíslo modelu
Številka modela / Număr model / Broj modela
Modelnummer / Numer modelu

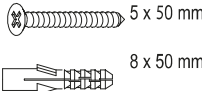
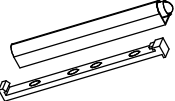
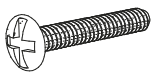
2302.862.84

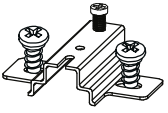
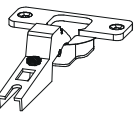
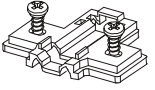
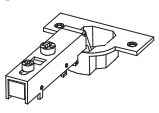
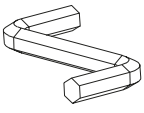
Type / Tipo / Tipus / Тип / Тип / Tip

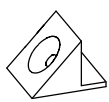
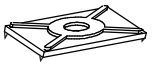
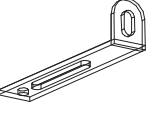
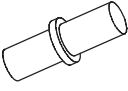
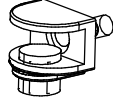
862

B1

 A0/1 x32	 A1/1 x10	 B0/10 x8	 B1 x8	 U5 x4
 C0/2 x34	 C0/11 x12	 C2 x30	 C7 x46	 C22/7 x6
 C30 x8	 D5 x66	 D36 x24	 D37 x6	 E0 x2
 F5 x1	 H8 x4	 J0/1 x2	 J0/2 x1	 J6 x3
 J5 x3	 J33 x6	 J60 x6	 K x1	 L166 x2
 M1 x24	 M3 x18	 P0 x2	 Q0 x24	 Q6 x8
 T82 x6	 U1 x20	 B4/6 x2		

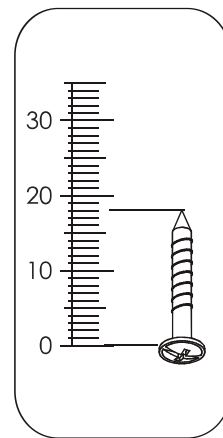
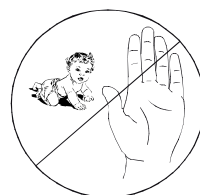
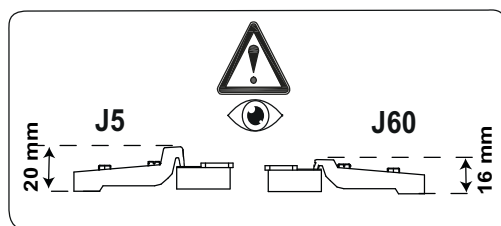
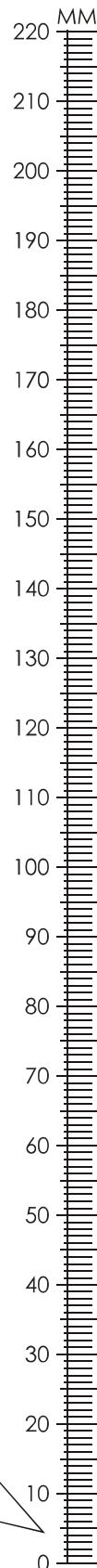

Değerli müşterimiz, evde kullanım için tasarlanan iç mekan programımızdan bir mobilya satın aldığınız için teşekkür ederiz. Lütfen teslimat kapsamının eksiksiz olup olmadığını kontrol edin ve montajdan önce aşağıdaki önemli bilgileri dikkatlice okuyun ve daha sonra üçüncü şahıslar tarafından da kullanılmak üzere saklayın.

Mobilyalarımız amaçlandığı şekilde kullanılmalıdır. Amacı dışında kullanım, maddi hasarlara veya bazı durumlarda kişisel yaralanmalara neden olabilir. Mobilyalar çocuk oyuncakları değildir. Üretici veya satıcı, amacı dışında veya yanlış kullanımdan kaynaklanan hasarlar için hiçbir sorumluluk kabul etmez.

D İ K K A T: Çocuklar veya zihinsel engelli kişiler, yaralanma ve/veya bozulma riski bulunduğundan, mobilya parçalarından, sivri uçlu nesnelere, küçük parçalardan ve ambalaj malzemelerinden daima uzak tutulmalıdır.

M O N T A J: Montaj sırasında lütfen işlemin, kullanım, kurulum veya montaj talimatlarınıza uyun ve uyan ve güvenlik talimatlarına özellikle dikkat edin. Talimatlara uyulmaması, kişisel yaralanmaya veya mobilya hasarına/güvenlik riskine neden olabilir.

Montaj / kurulum konusunda zorluk yaşıyorsanız, lütfen servis ekibimize iletişime geçin. Ekibimiz tavsiyeleriyle ve destekleriyle size yardımcı olacaktır. Montaj sadece uzman kişiler tarafından yapılmalıdır.

Ürün/ürün parçalarında değişiklikler, üreticiden/satıcıdan gelmeyen parçalarla/sarf malzemeleriyle değiştirilmesi veya kullanılması durumunda meydana gelebilecek hasarlar için sorumluluk kabul edilmez.

Ürünlere dübel ve vida gibi duvara sabitleme araçları eklenmişse, bunlar sadece sağlam ve tek tip malzemelerden yapılmış duvarlarda kullanılmak üzere tasarlanmıştır. Bir bağlantı sadece bağlantı elemanı ve duvar arasındaki bağlantı kadar iyidir. Lütfen mobilyayı sabitlemeden önce duvarınızın hem ayakta hem de asılı mobilya için uygunluğunu kontrol edin ve sadece uygun bağlantı elemanları kullanın. Olası bir delme işleminden önce delme alanında tesisat olmadığından emin olun. Sonuçta, montaj yapan kişi duvara sabitlemekten sorumludur.

Bu aynı zamanda elektrikli parçaların ve diğer yapısal aksesuarların montajı için de geçerlidir. Elektrikli parçaların ve diğer inşaatla ilgili aksesuarların montajı/kurulumu sadece yetkili uzman personel tarafından yapılabilir. Tüm elektrik ve yapısal kurulumlar, eyaletinizdeki geçerli standartlara ve güvenlik yönetmeliklerine uygun olarak yapılmalıdır.

Işık kaynakları için lütfen sadece izin verilen aydınlatma güçlerini kullanın. Maksimum Watt değerine uyulmaması durumunda aşırı ısınma nedeniyle yangın riski söz konusudur. Yangın tehlikesi nedeniyle aydınlatmaların üstünü kapatmak yasaktır.

Mobilyaların düzgün fonksiyonu sadece düz ve yatay konumda garanti edilir. Kapılar önceden ayarlanmıştır, ancak yerel koşullar nedeniyle yeniden hizalanması/ayarlanması gerekebilir. Lütfen maksimum yük ile ilgili ağırlık bilgilerine uyun. Mobilyaların üzerine çıkılması yasaktır. Yanlış kullanım mobilyaların devrilmesine neden olabilir.

Bunu önlemek için mobilyalar her zaman devrilmeye karşı emniyete alınmalıdır. Aşırı yük/aşırı zorlama durumunda (özellikle oyun oynayan çocuklar, insanlar, malzeme veya diğer uygunsuz etkiler nedeniyle) kırılma ve yaralanma riski söz konusudur. Kalıcı sağlamlığı güvenceye almak için tüm vidalar ve yük taşıyan bağlantı noktaları 5-6 hafta sonra tekrar sıkılmalıdır.

B A K I M:
-Mobilya bakımına ilgili notlar-
Ürününüzün keyfini otobildikince uzun süre çıkarabilmeniz için lütfen uygun mobilya bakımıyla ilgili talimatlarımızı dikkate alın.

Temizlik sırasında temiz, kuru ve yumuşak pamuklu bir bez kullanın. Mobilyanızın kapsamlı bir temizliğe ihtiyacı varsa, bezi biraz su veya mobilya temizleyicisiyle nemlendirilebilir ve ardından temizlenen eşyaları kurutabilirsiniz. Metal ve cam parçaları, üzerindeki bakım talimatlarına göre piyasada bulunan metal ve cam temizleyicilerle en iyi şekilde temizleyebilirsiniz. Temizlik maddeleri, mobilya temizliği için uygun olduklarının açık bir göstergesini taşımaktadır.

Hiçbir koşulda buharlı temizleyiciler, kostik, aşındırıcı veya etkilere aşırı olmadığınız diğer maddeleri kullanmamalısınız.

D İ K K A T: Çok parlak yüzeyler teslimat sırasında koruyucu bir folyoyla korunur. Bunu tamamen monte edilene ve tozu temizlenene kadar mobilya üzerinde bırakın. Koruyucu folyonun çıkarıldığı çok parlak elemanlar ancak 72 saat sonra temizlenebilir ve kullanılabilir (ortam havasında son katlaşma süresi). Yüzeylere keskin nesnelere zarar vermemeyi ve asla güçlü güneş ışığına maruz bırakmayın.

T A S F İ Y E
-Tasfiyeyle ilgili notlar-
Çevre için lütfen türüne göre ayrılmış ambalaj atıklarını doğaya değil, bunlar için sağlanan atık/geri dönüşüm kutularında tasfiye edin.

Hasarlı veya kullanılmayan mobilyalar, her bir parçanın geri dönüştürülmesi için özel geri kazanım tesislerine gönderilebilir.



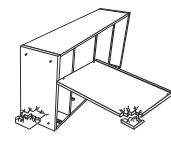
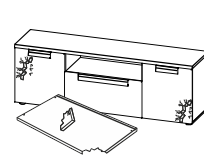
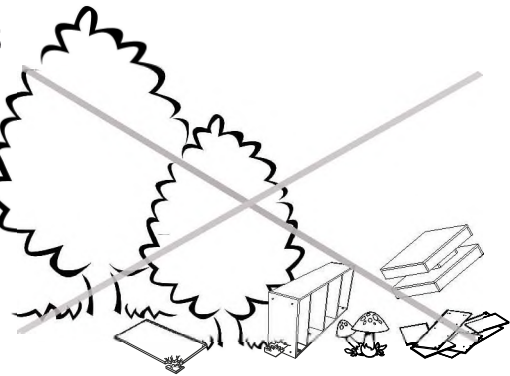
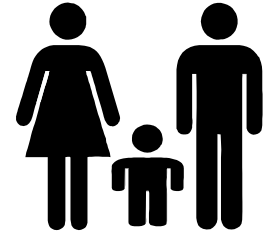
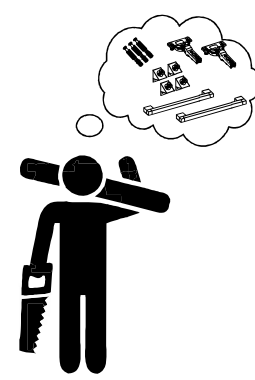
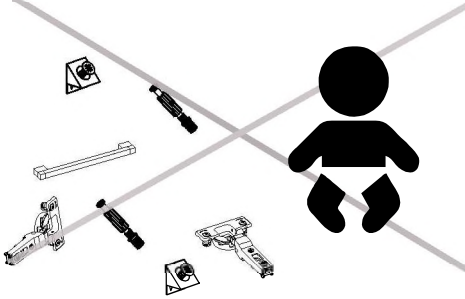
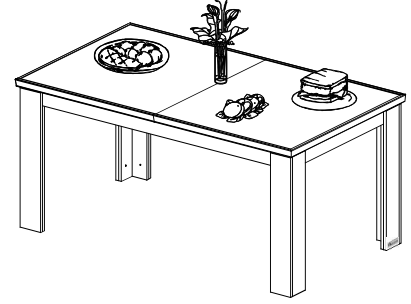
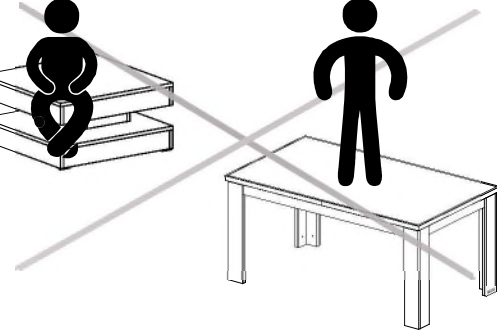
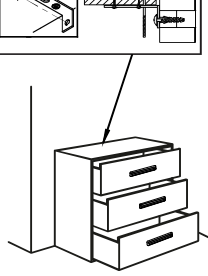
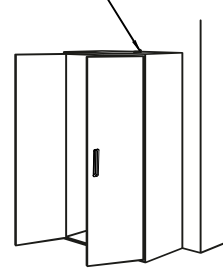
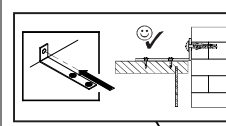
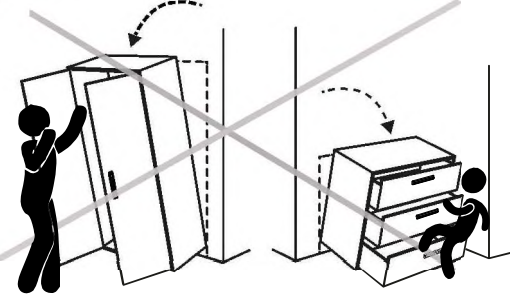

Artık kullanılmayan ancak hala işlevsel olan mobilyalarınızı hemen tasfiye edilmesi gerekmektedir. Bunları örneğin hayır kurumlarına bağışlayın.

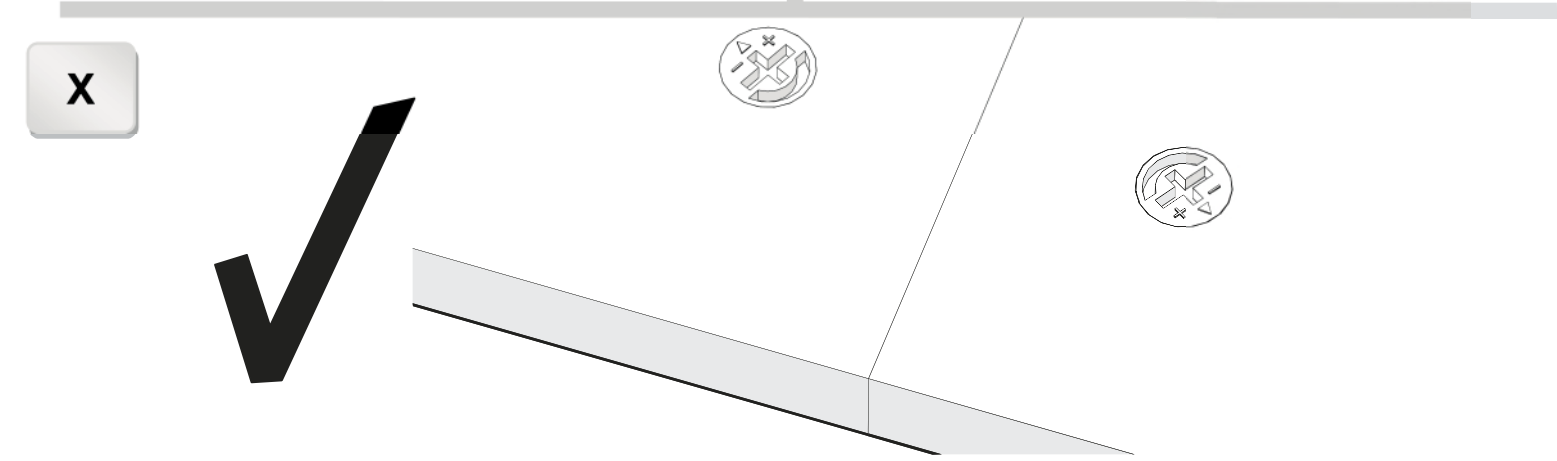
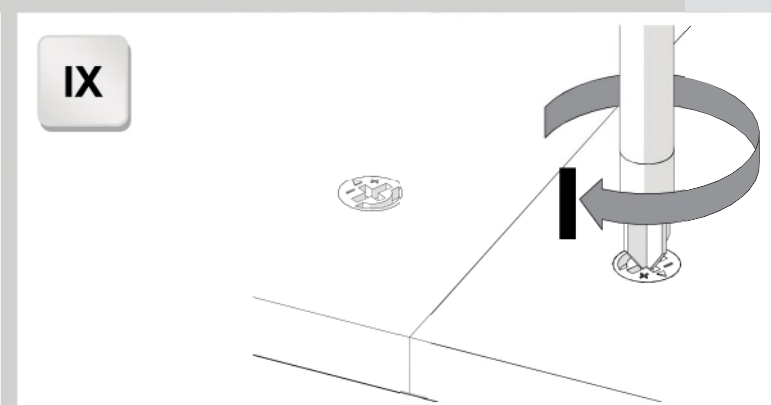
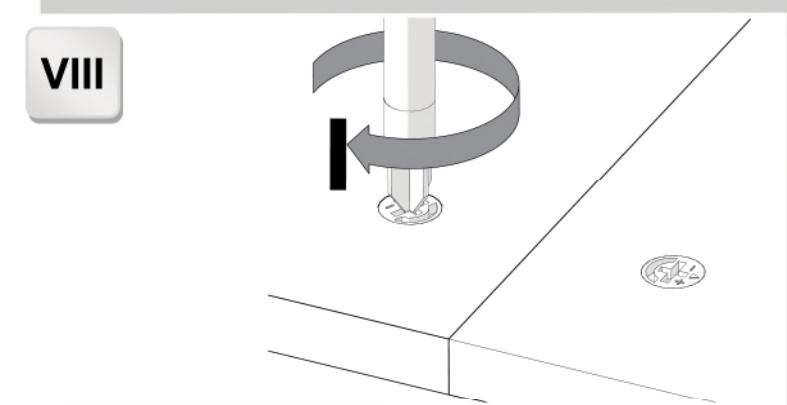
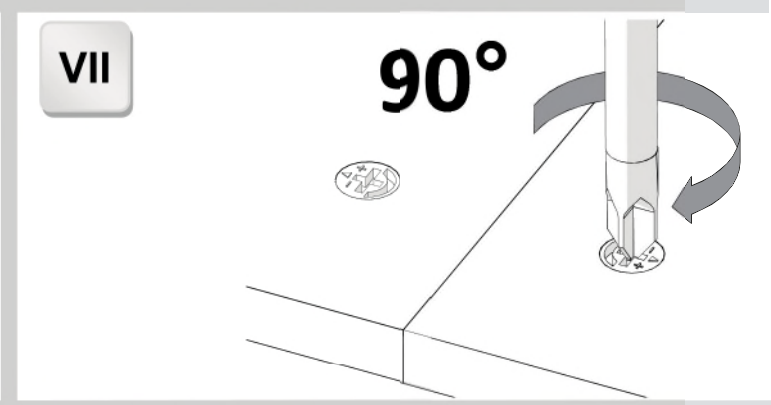
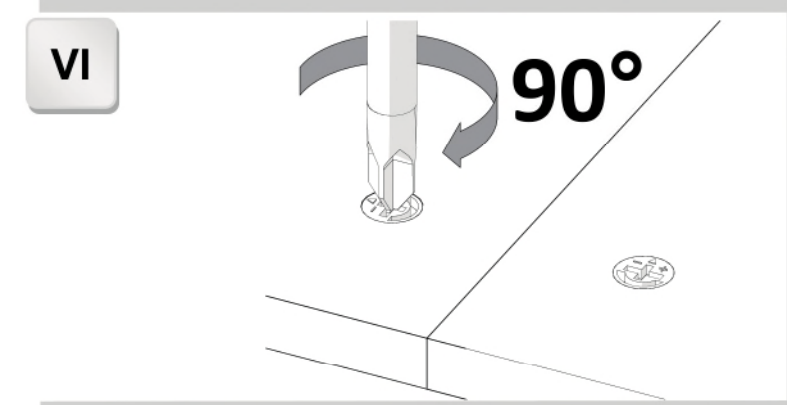
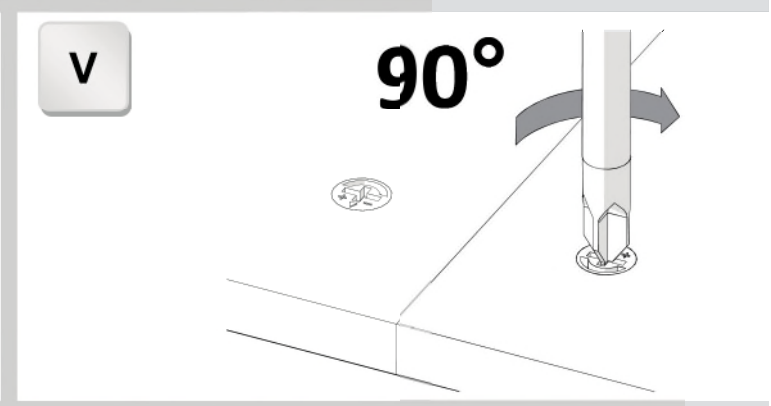
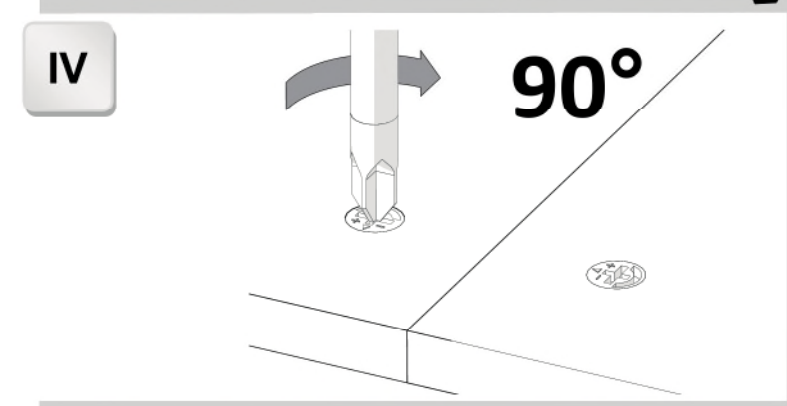
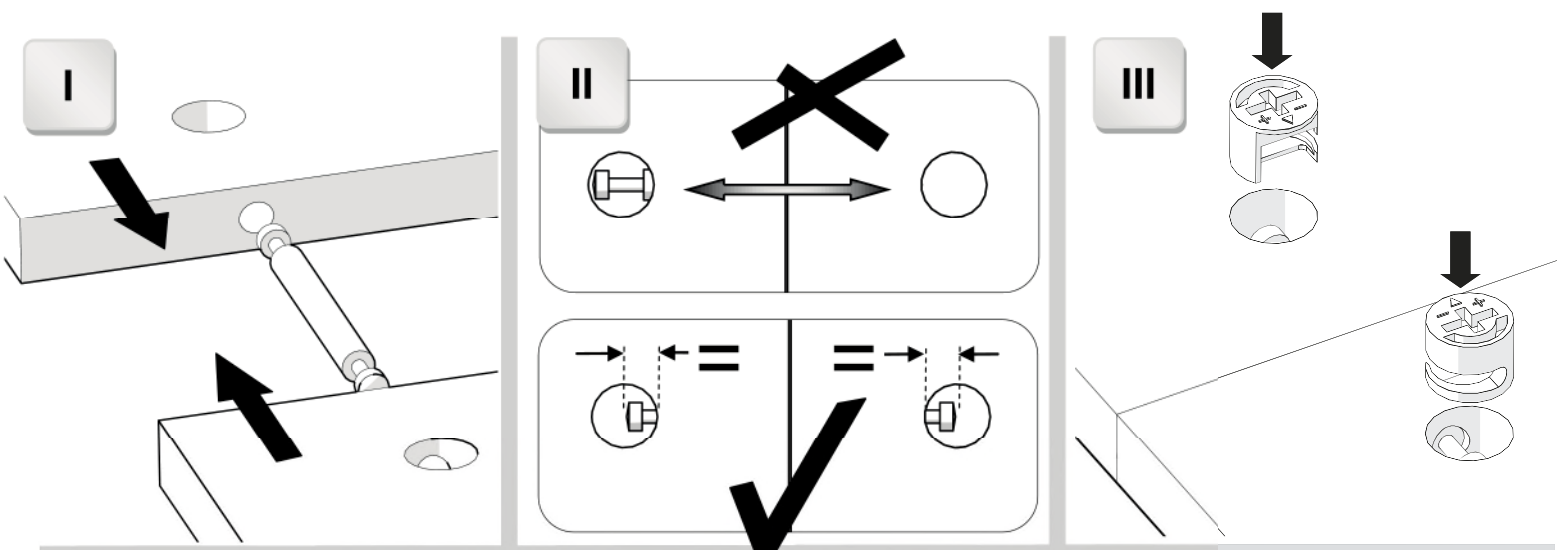
Yeni mobilyalarınızı güle güle kullanın.



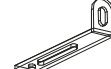
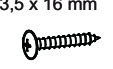

1

					
C2 x8	C7 x6	T82 x6	P0 x2	D36 x2	D38 x6

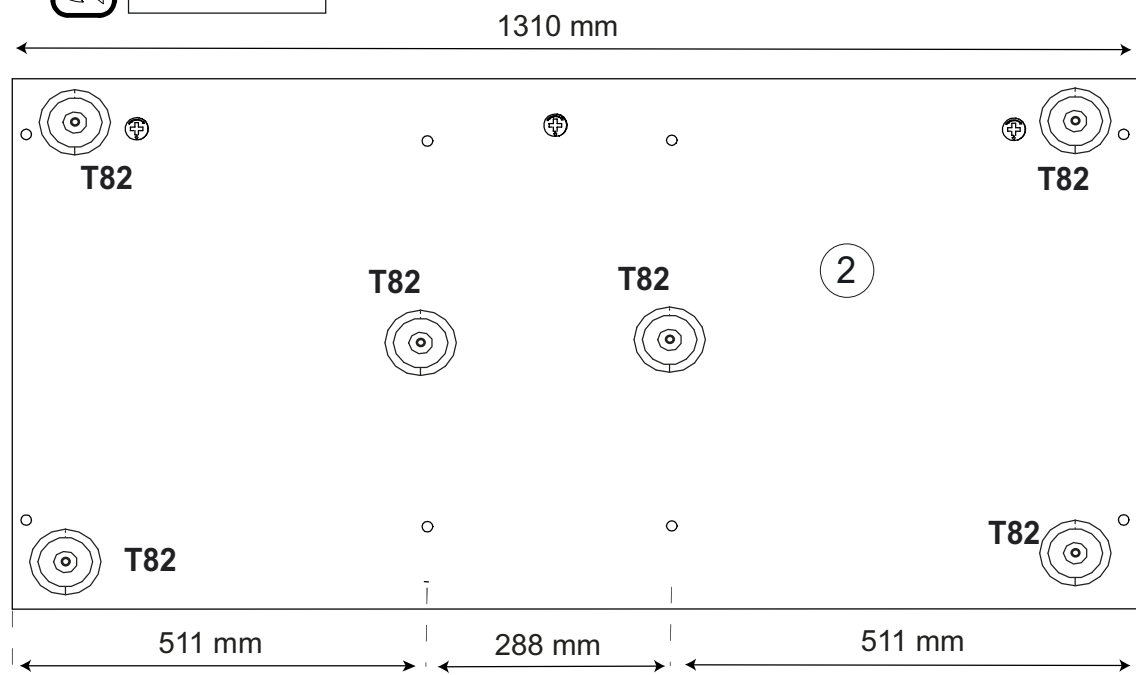
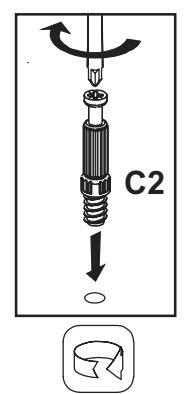
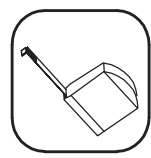
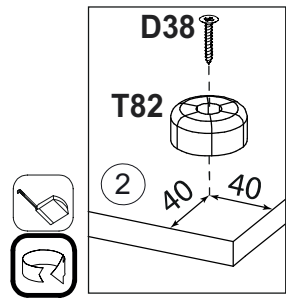
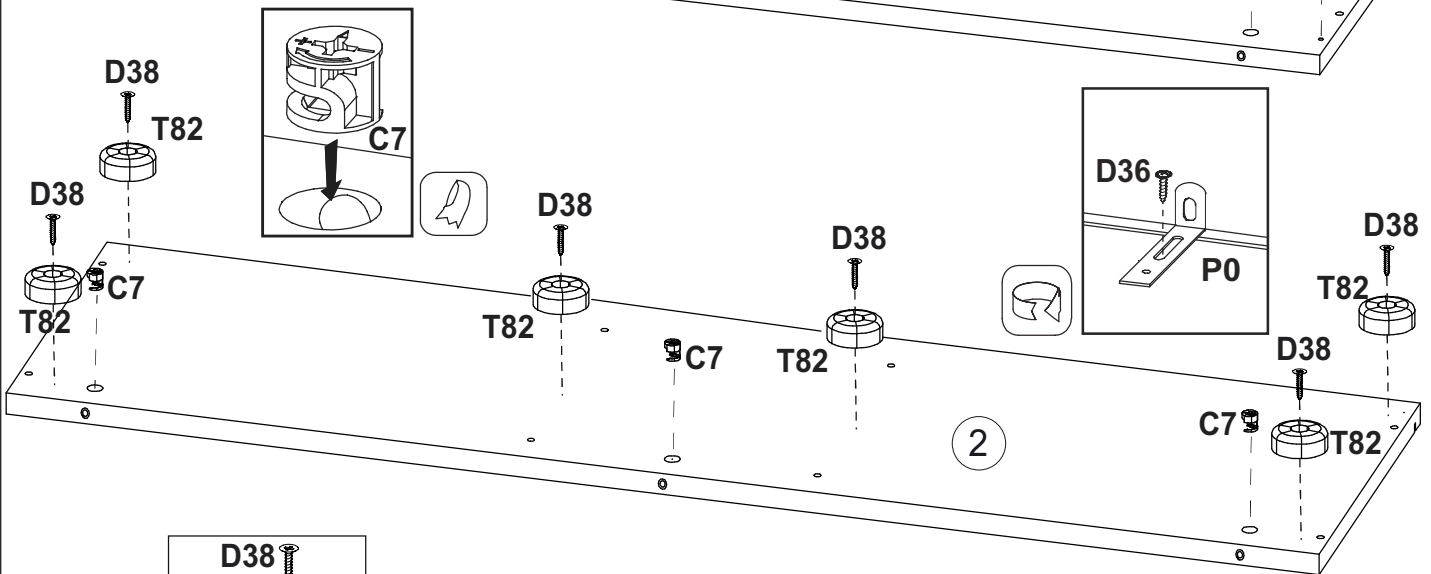
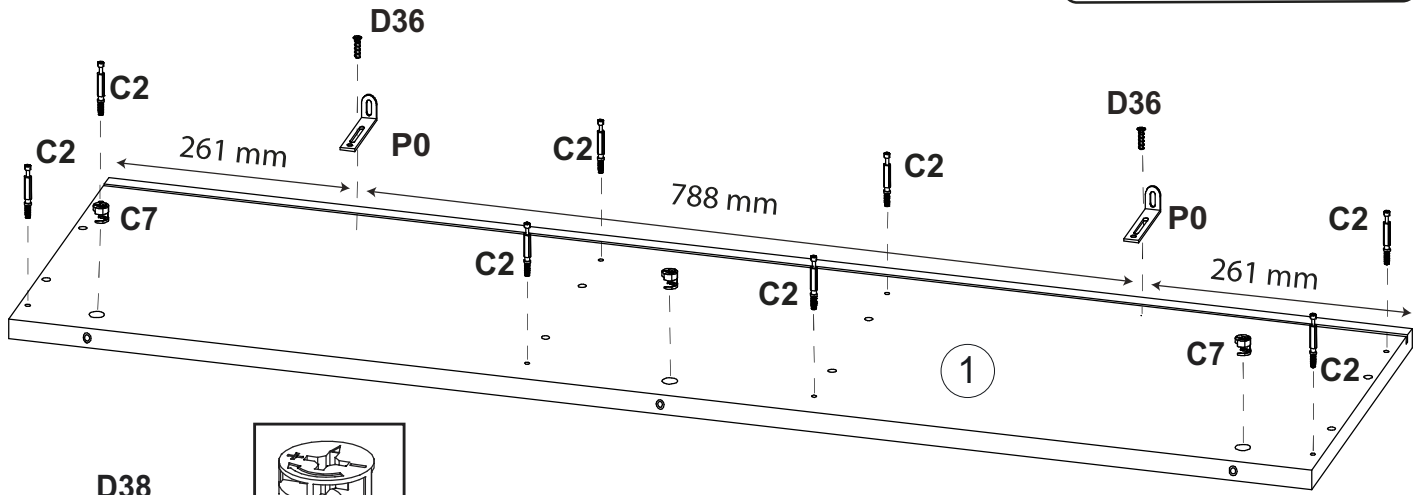
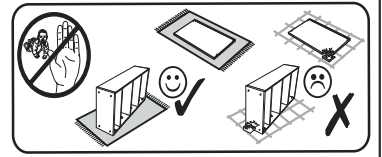



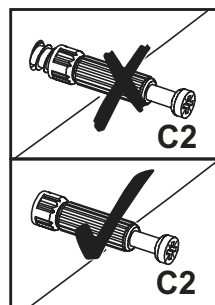
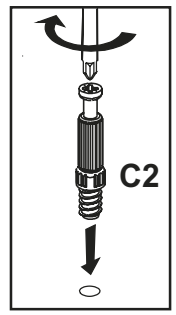
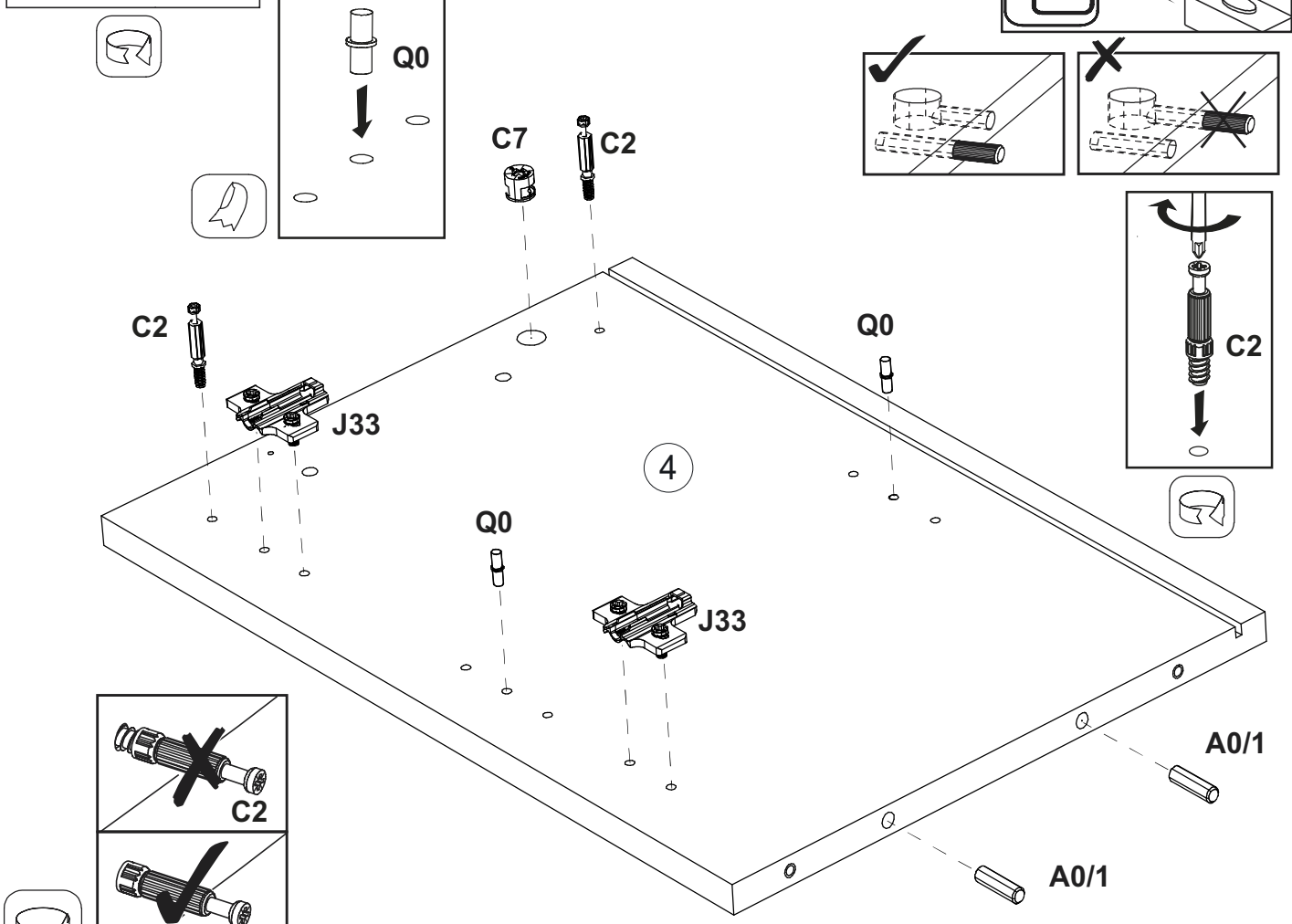
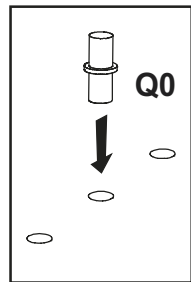
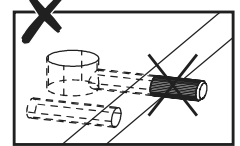
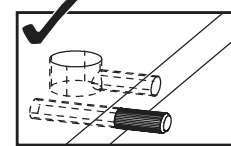
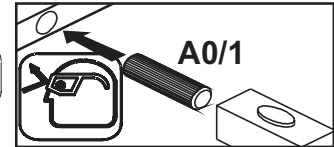
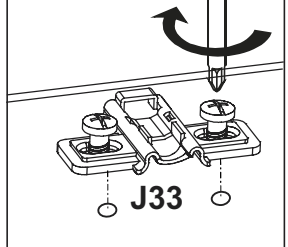
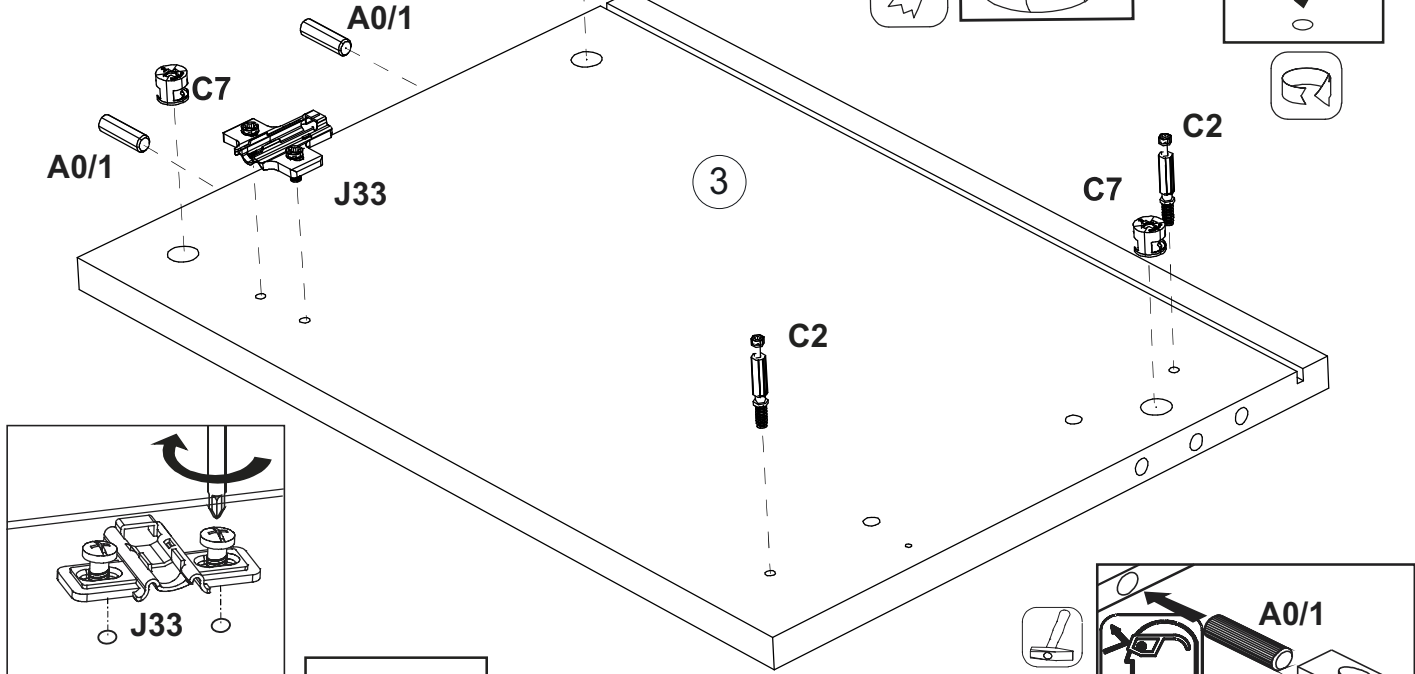
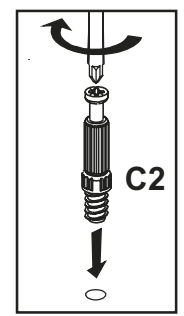
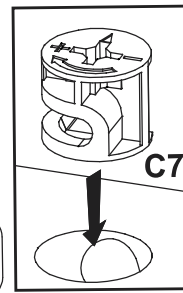

2

- C2 x4
- A0/1 x4
- Ø8x30
- C7 x4
- Q0 x2
- J33 x3

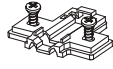

3

- | | | | | | | | | | |
|---|---------------------------|---|---|---|---|----|----|-----|----|
|  | $\varnothing 8 \times 30$ |  |  |  |  | | | | |
| C2 | x4 | A0/1 | x4 | C7 | x4 | Q0 | x2 | J33 | x3 |

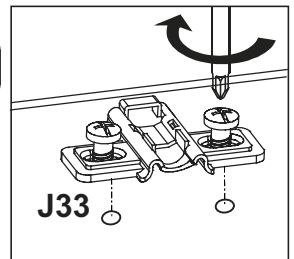
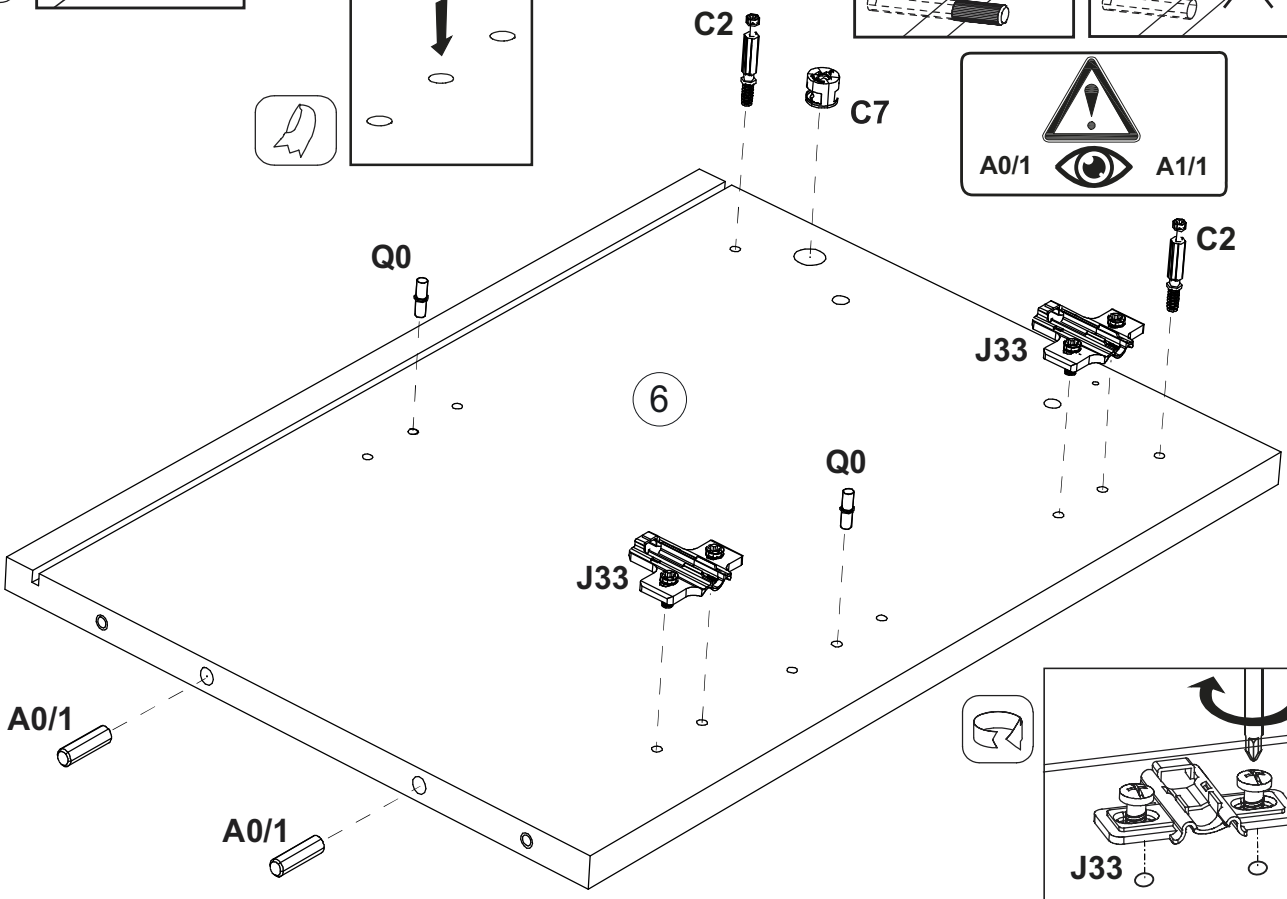
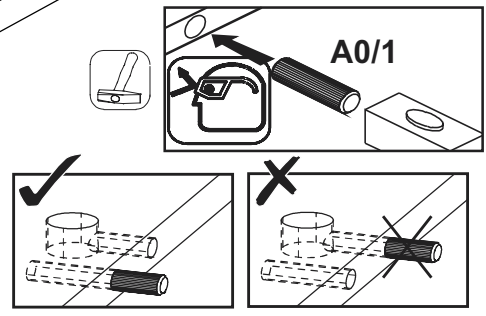
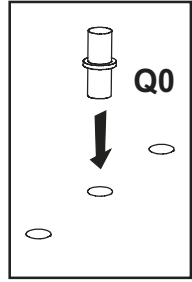
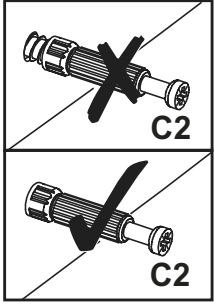
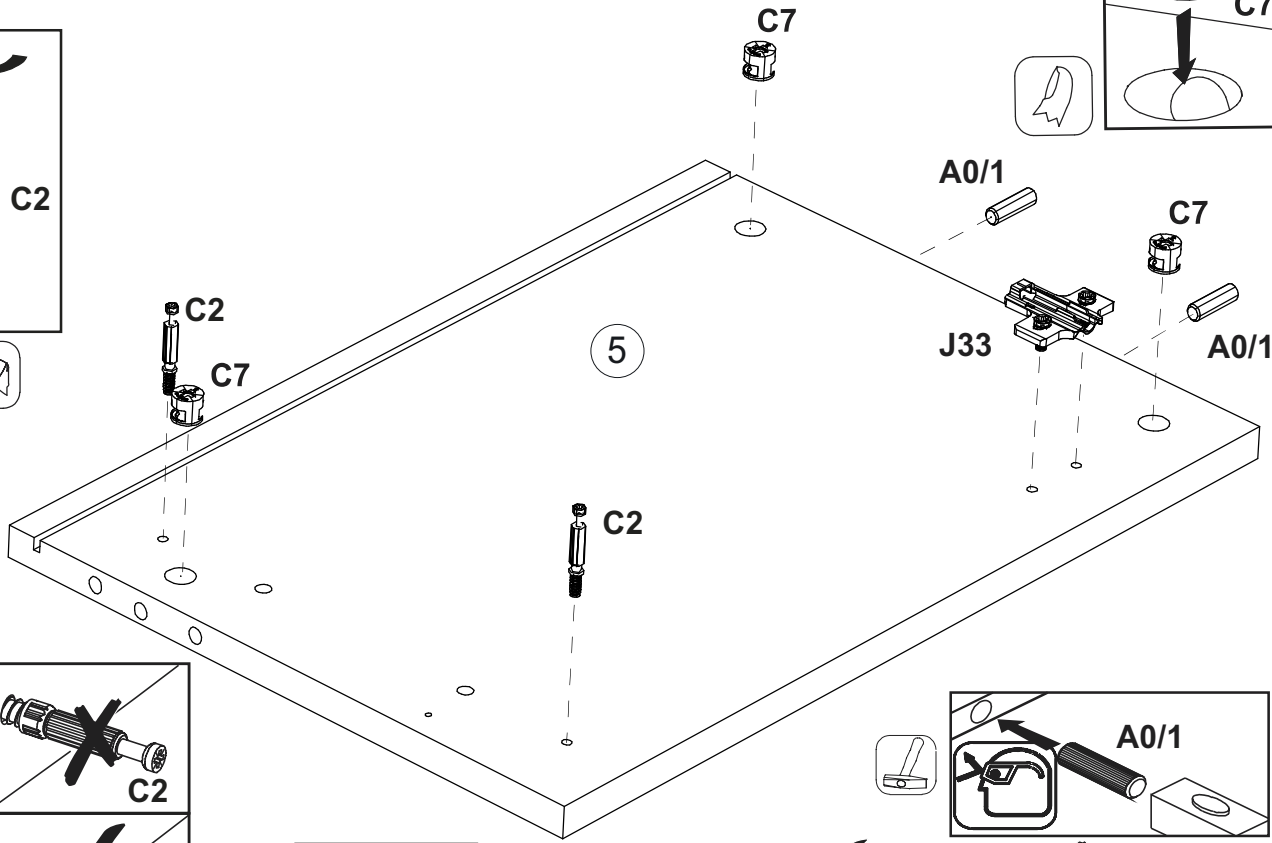
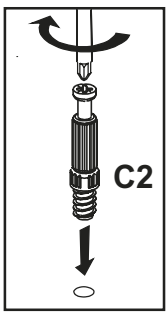
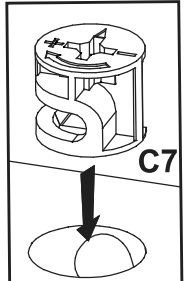

4

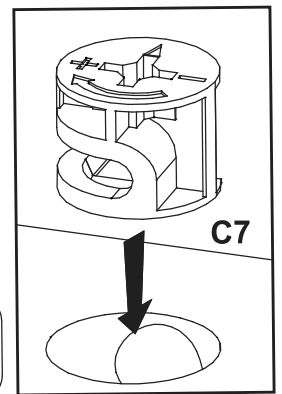
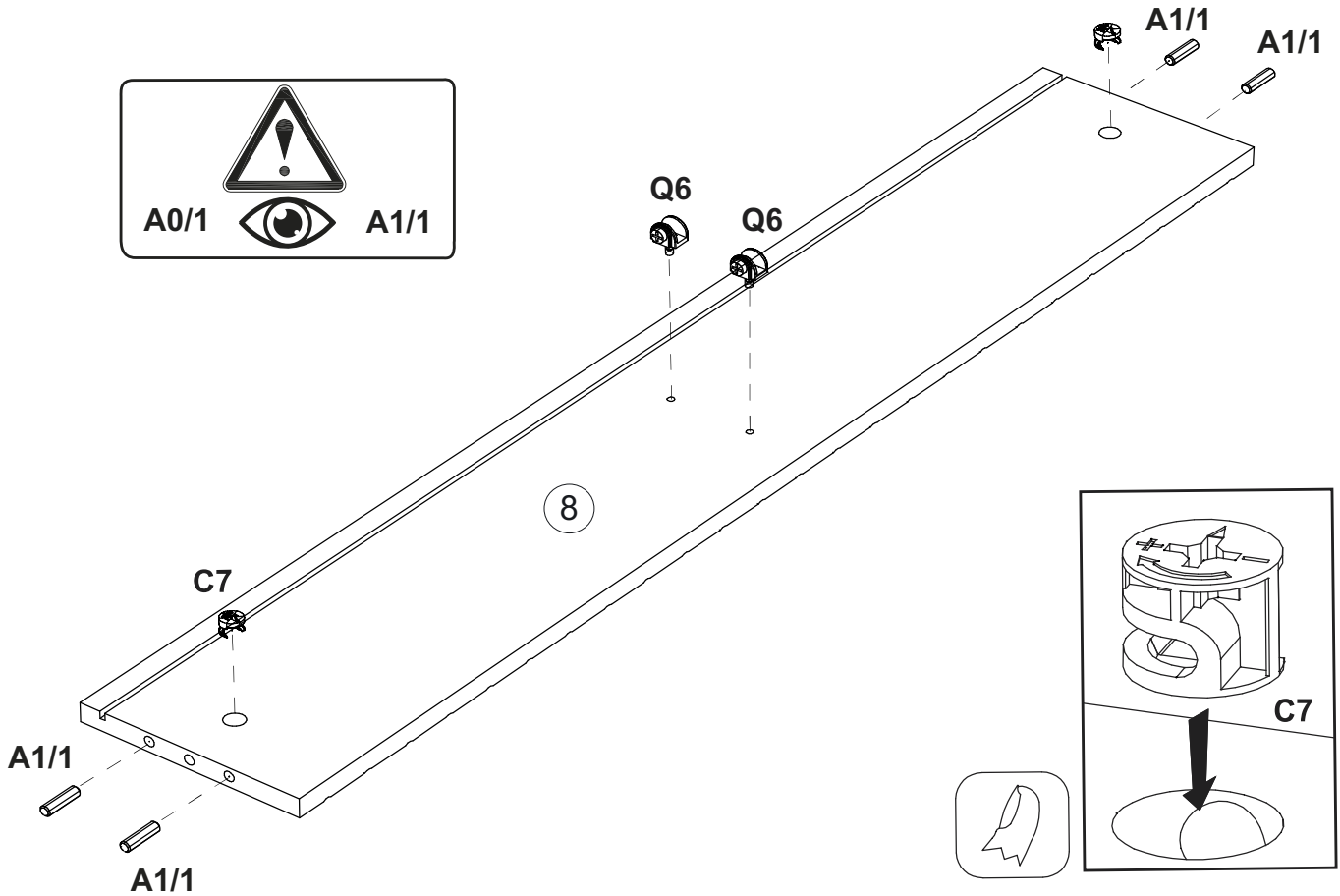
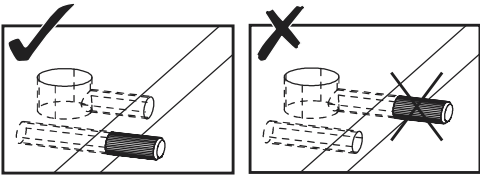
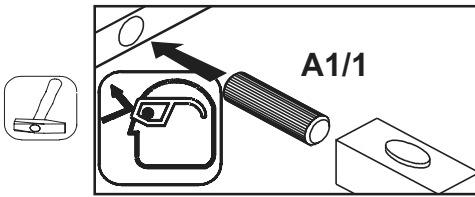
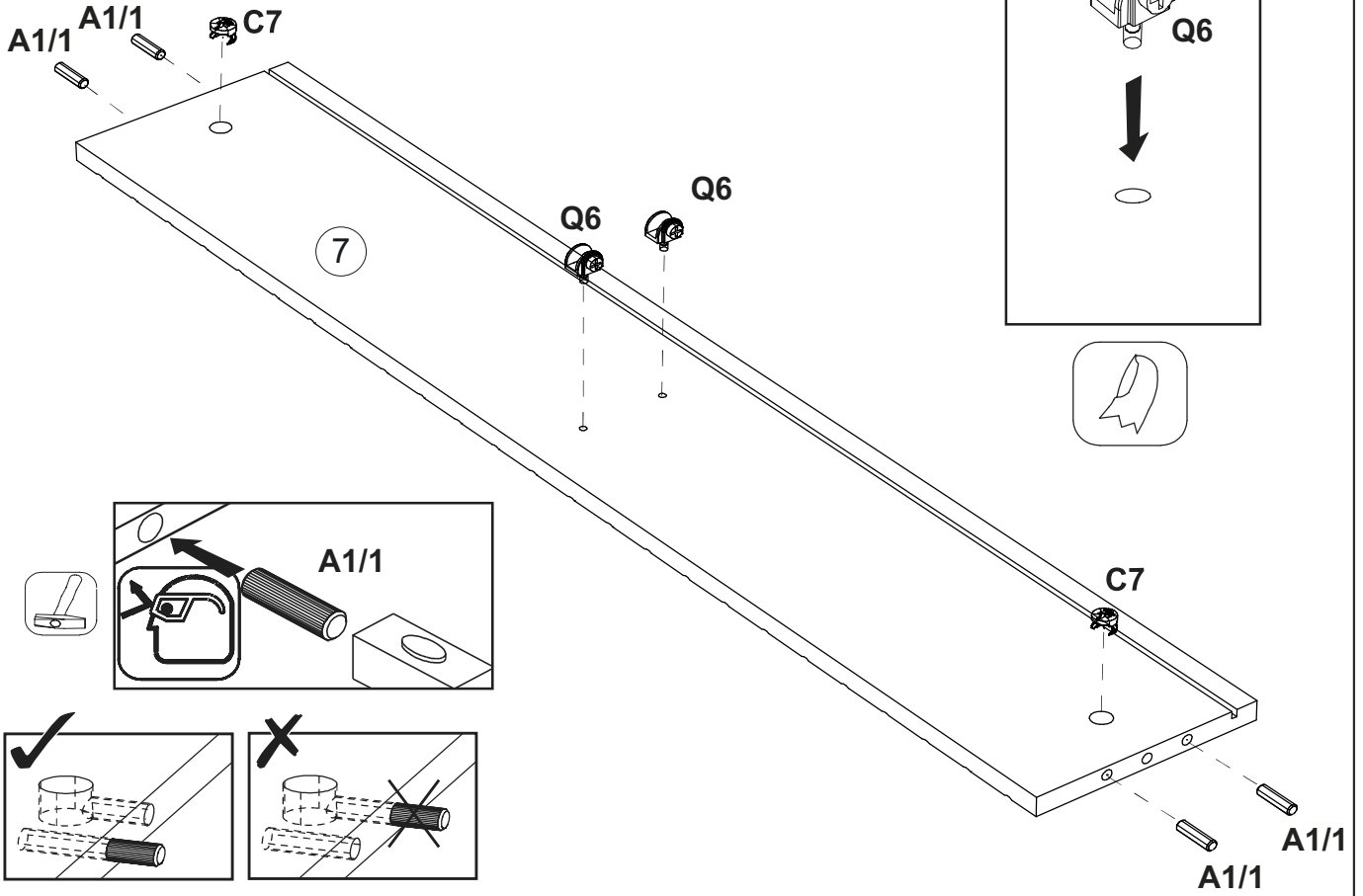
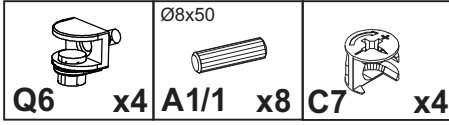



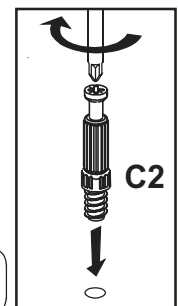
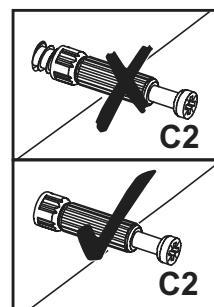
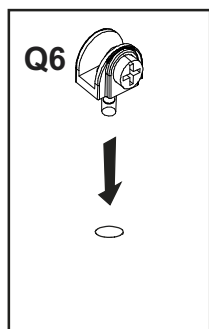
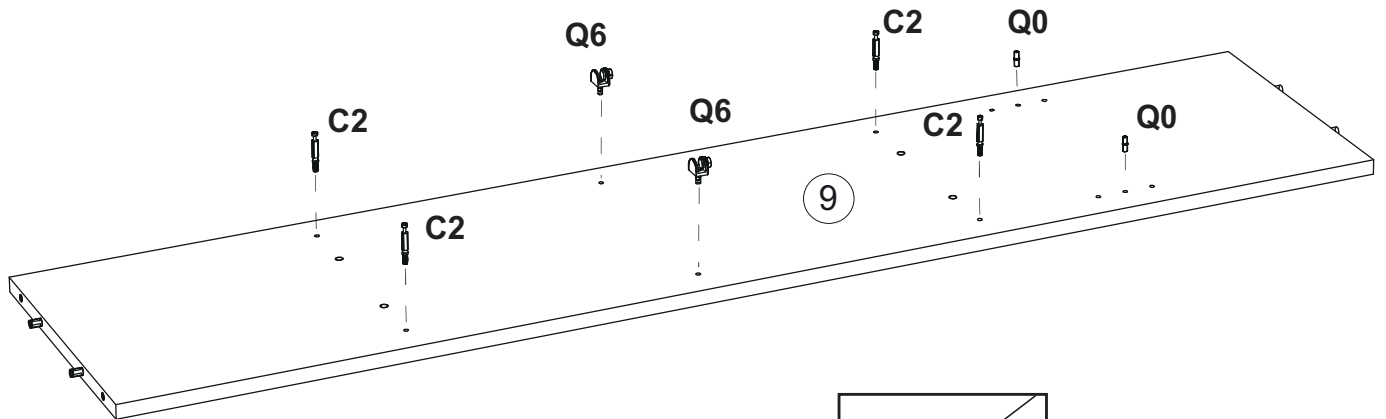
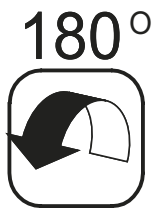
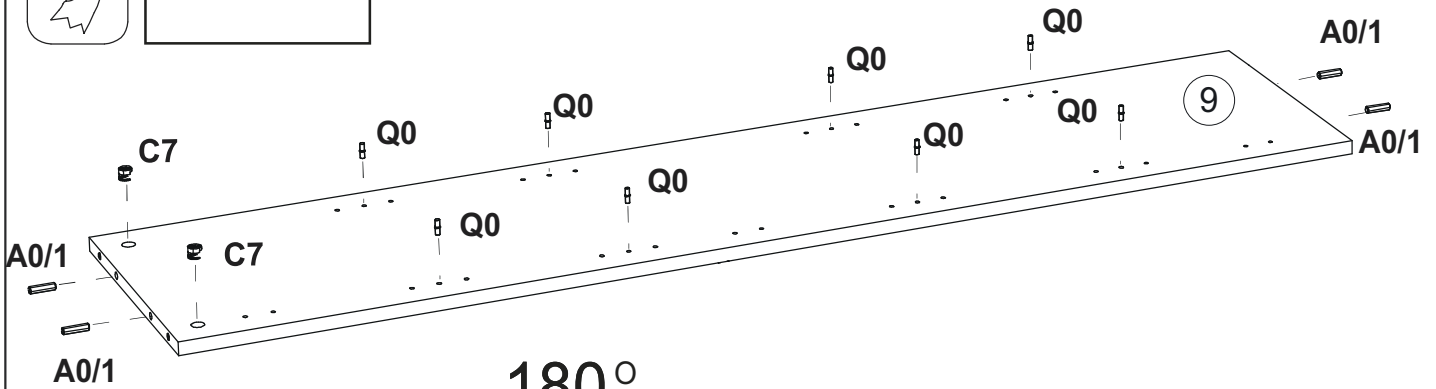
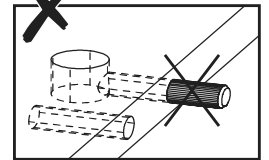
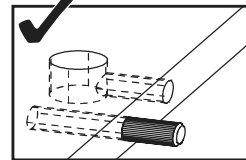
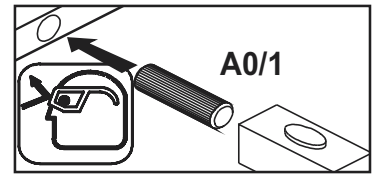
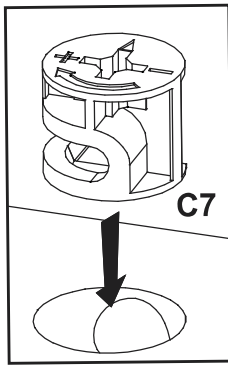
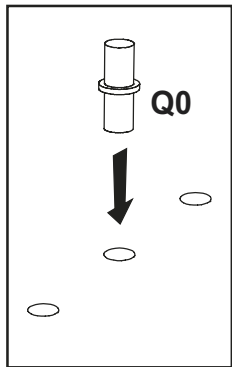

5

- C2 x4
- A0/1 x4
- Ø8x30
- C7 x2
- Q0 x10
- Q6 x2



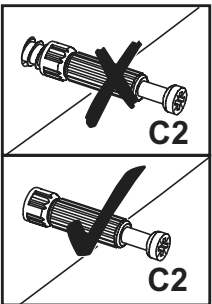
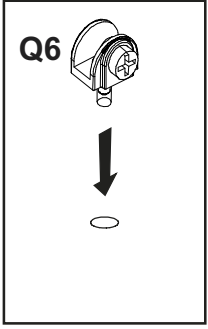
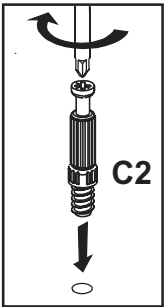
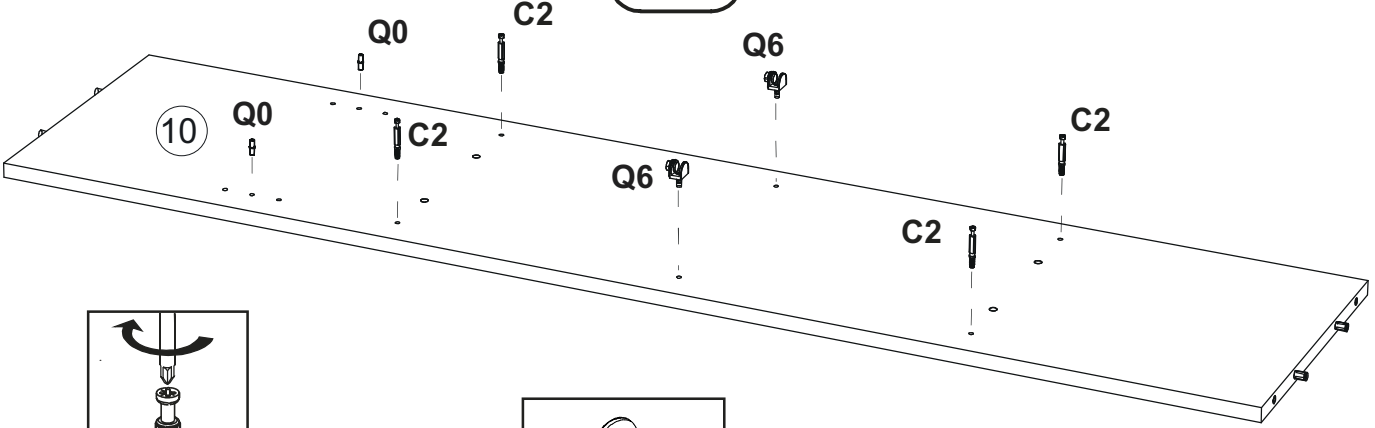
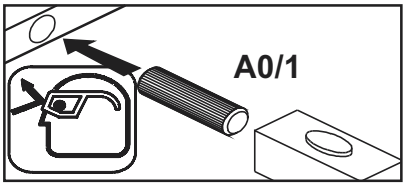
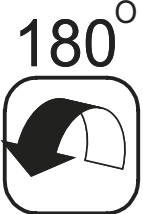
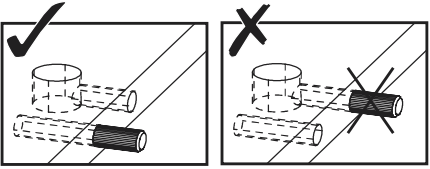
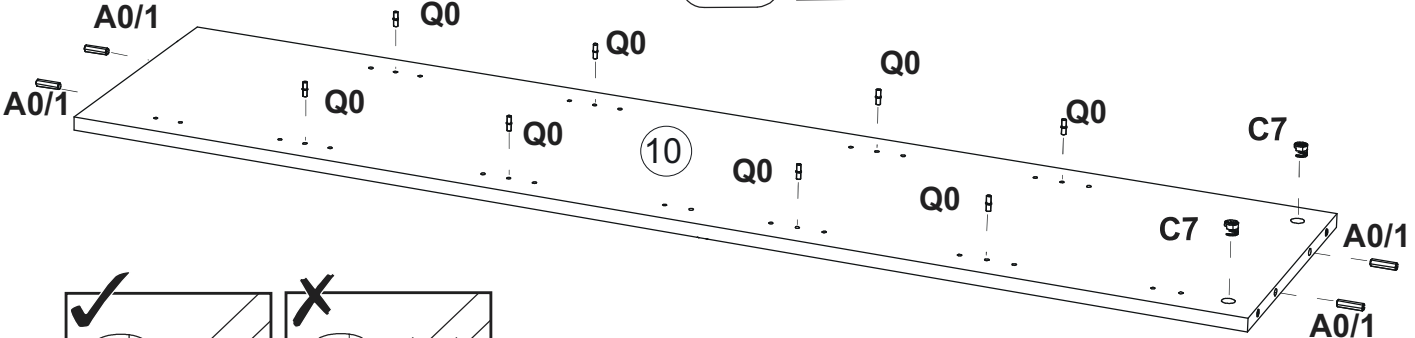
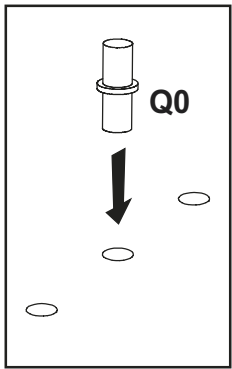
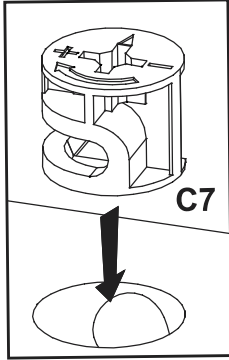

6

-  C2 x4
-  A0/1 x4
-  C7 x2
-  Q0 x10
-  Q6 x2



7



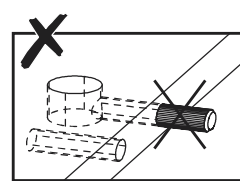
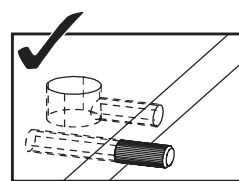
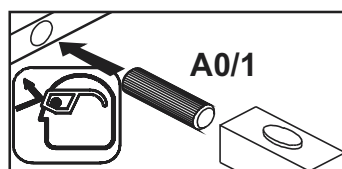
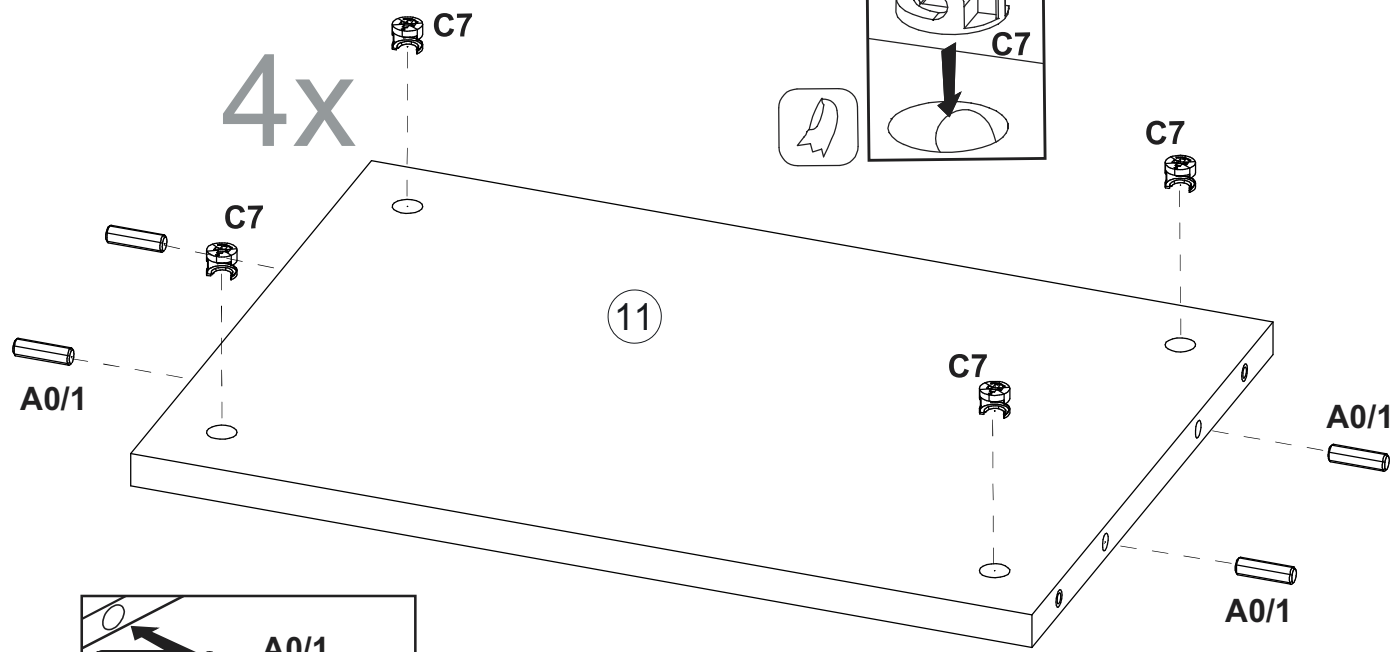
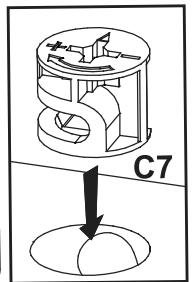

 C7 x16 A0/1 x16

Ø8x30



8



 C2 x6

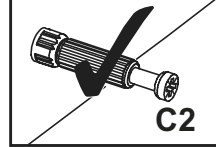
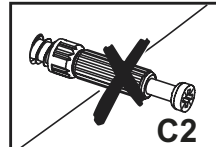
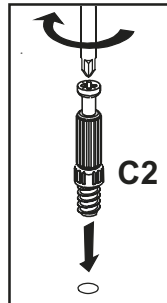
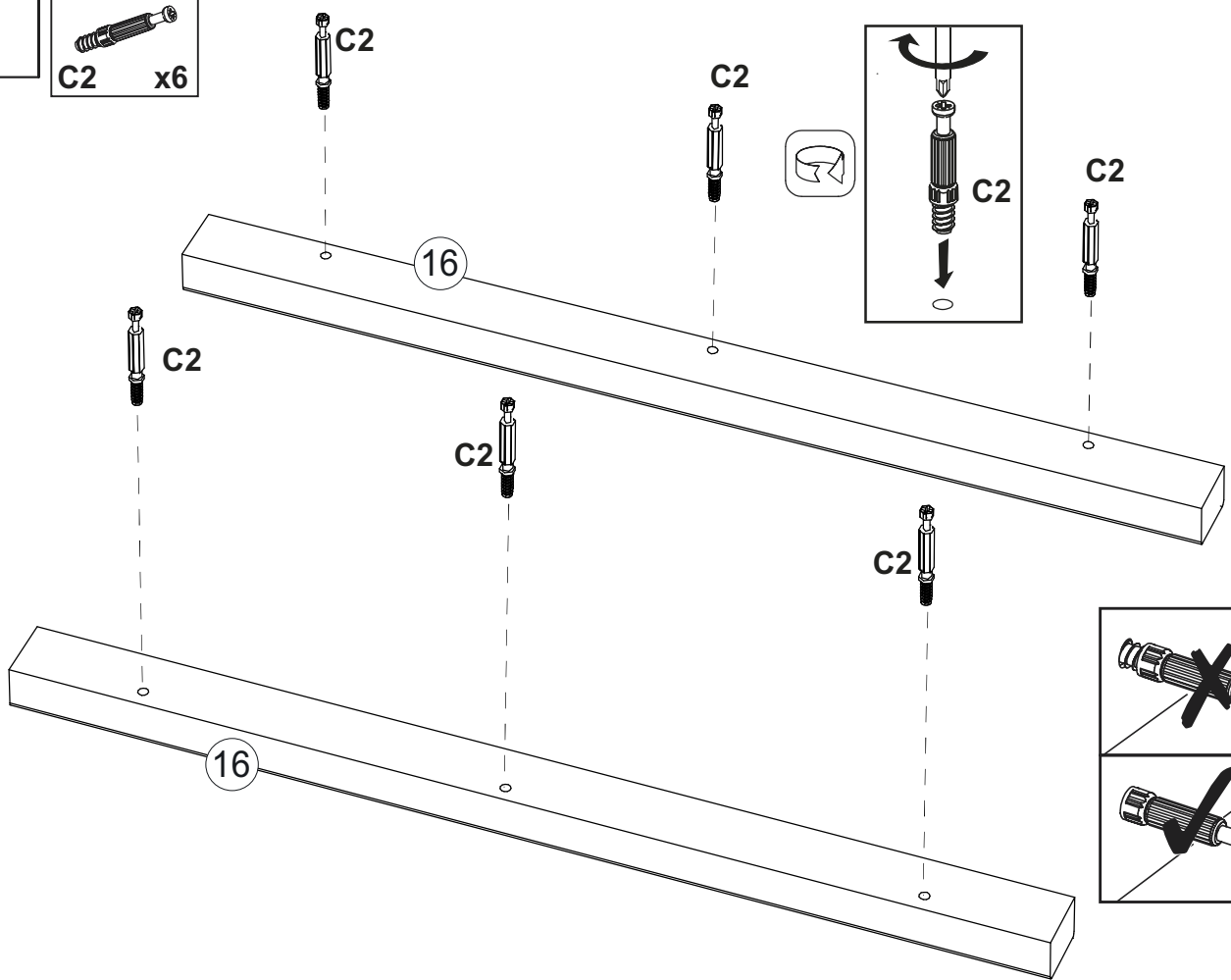

9

3.5x16
D5 x6 J60 x3

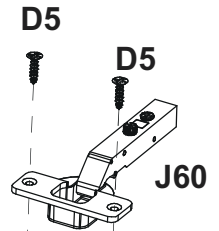
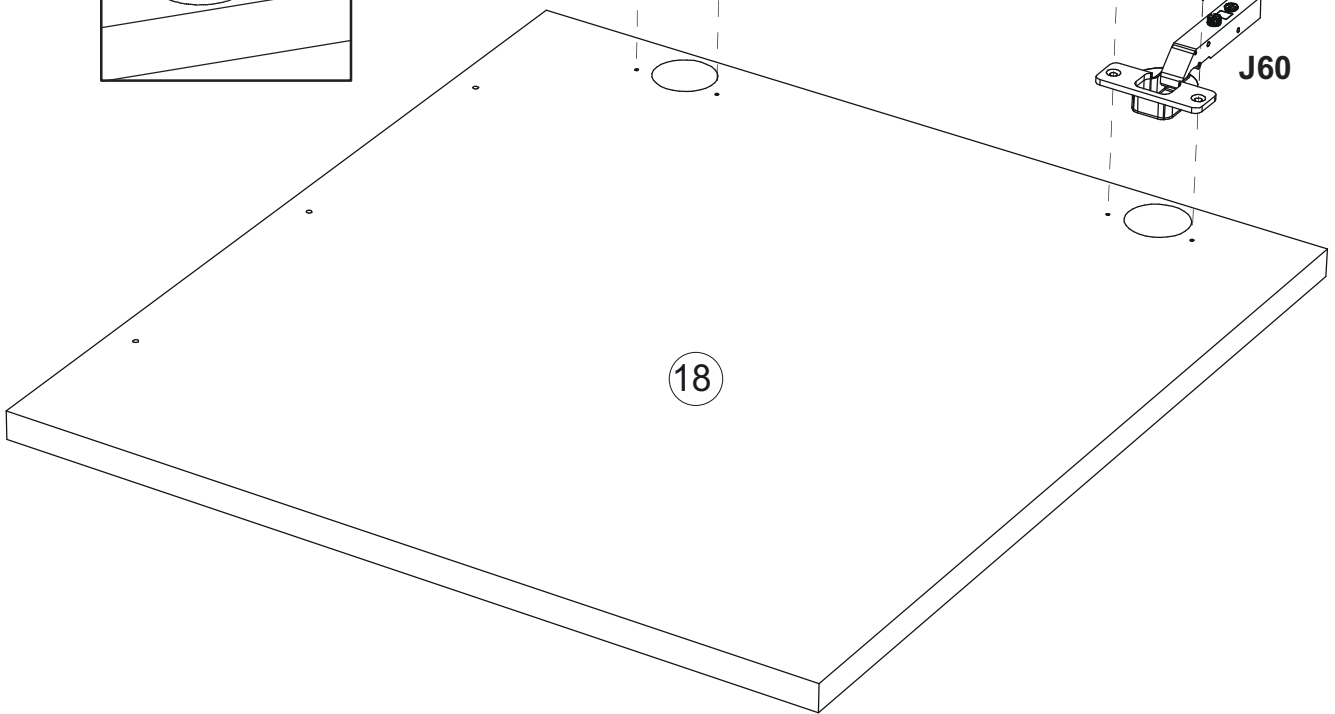
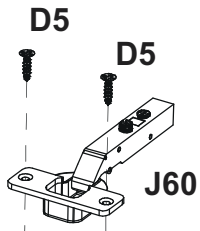
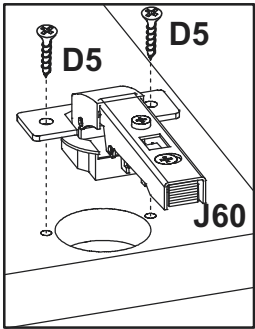
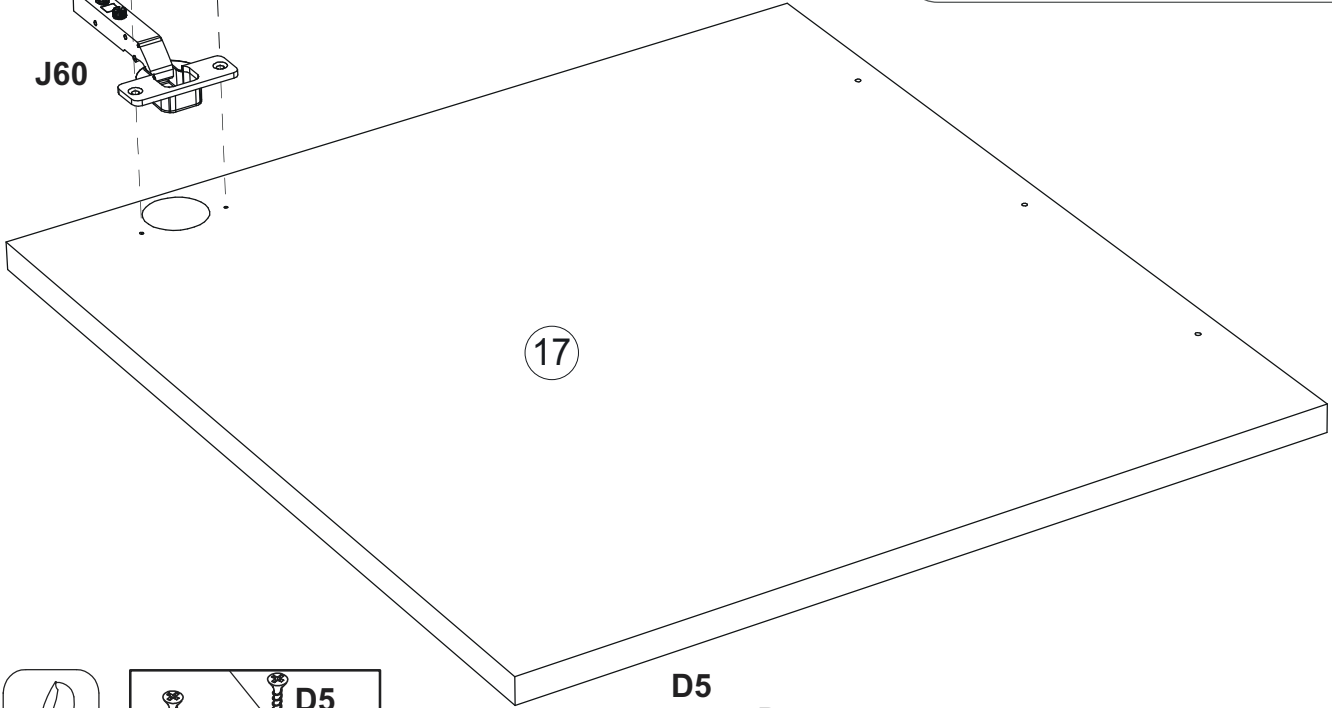
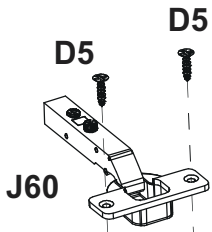
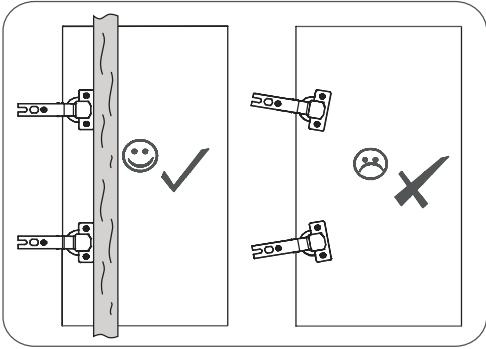
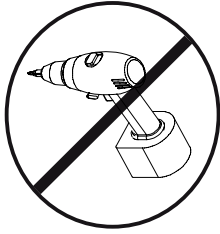

10

3.5x16



D5

x6

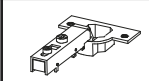

J60

x3

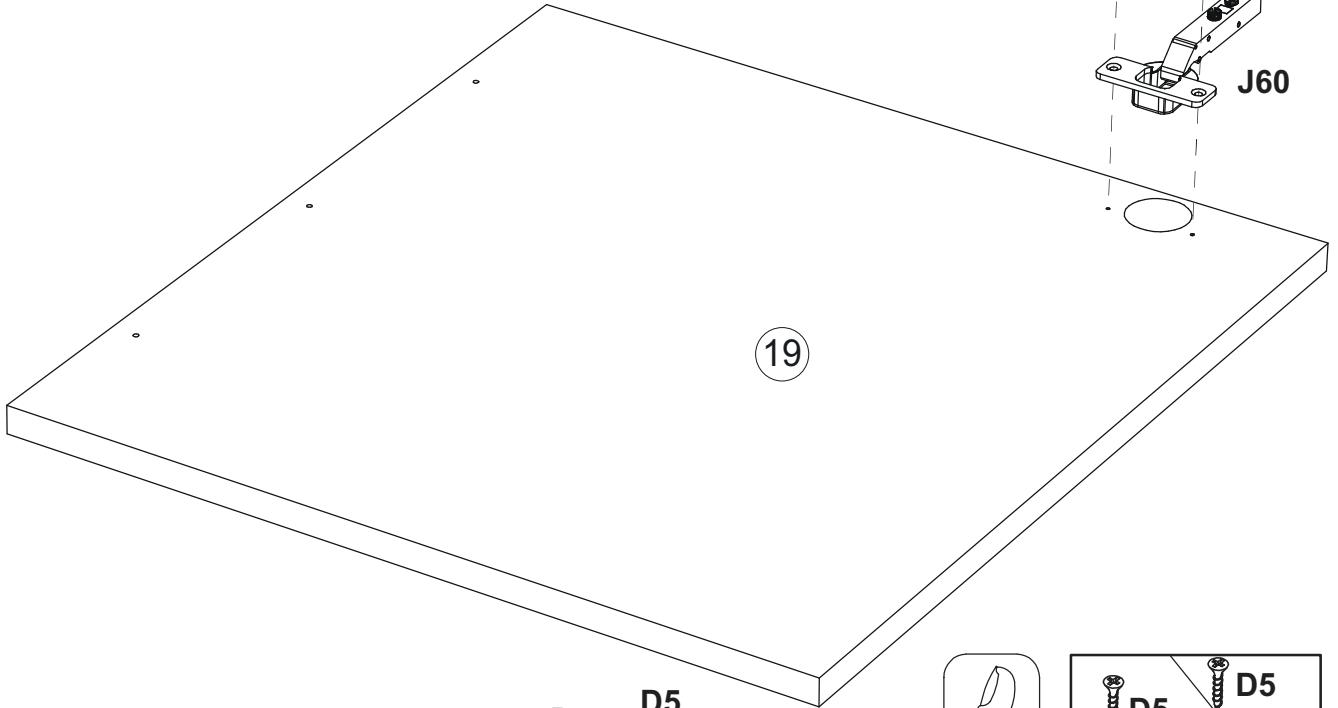
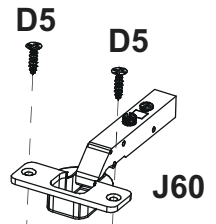
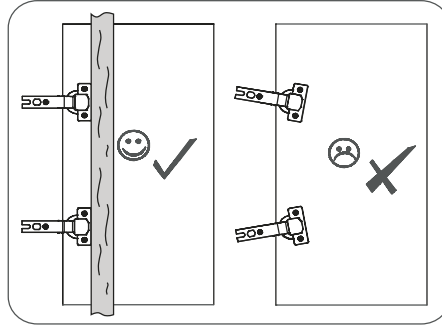

19

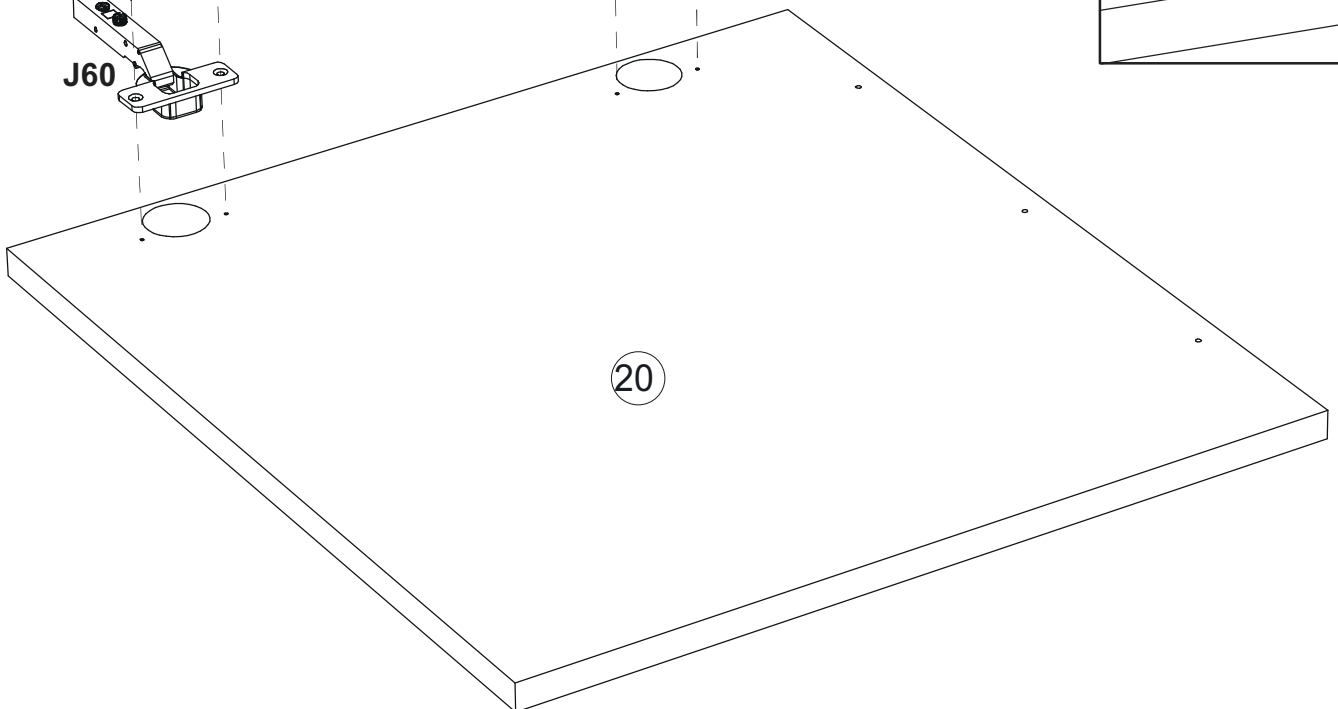
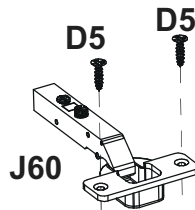
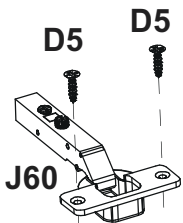
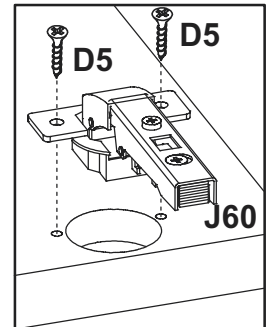

20

11

	$\varnothing 8 \times 50$
C7 x8	A1/1 x2

A0/1  A1/1

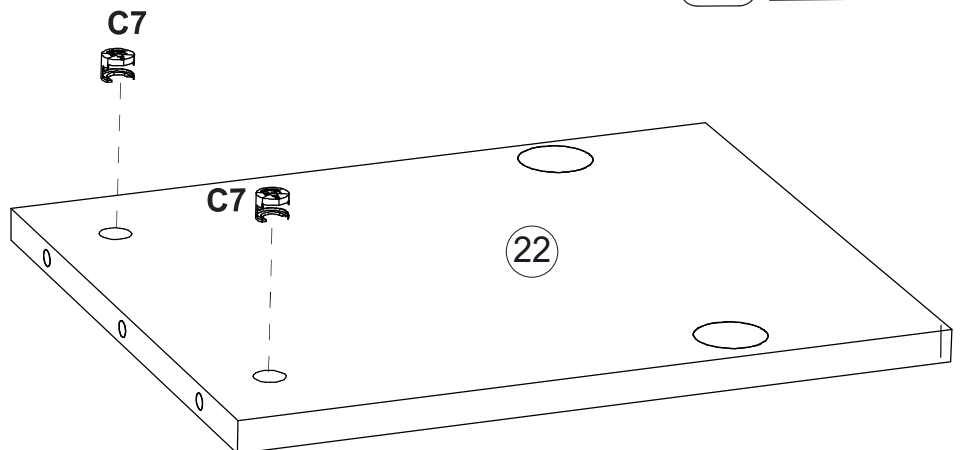
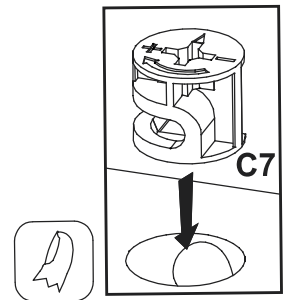
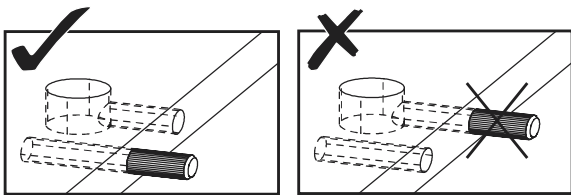
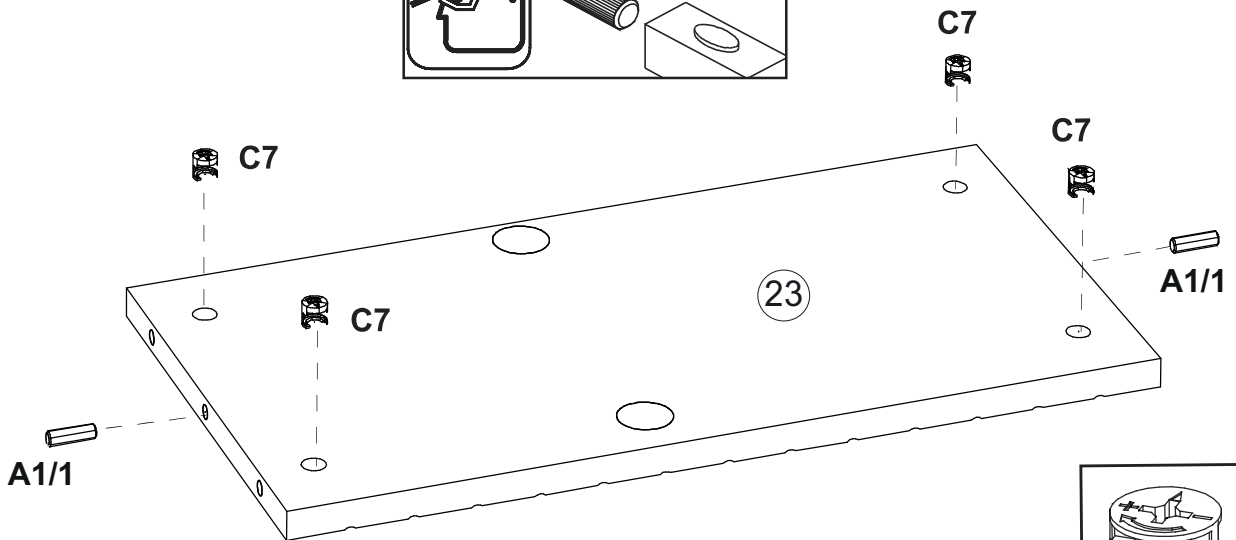
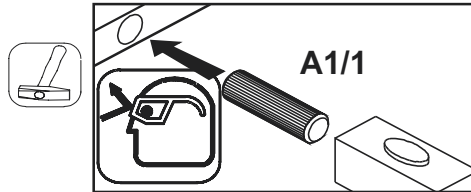
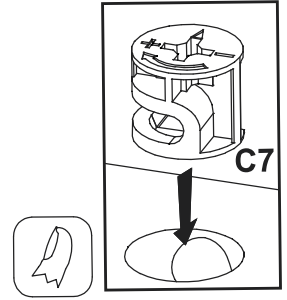
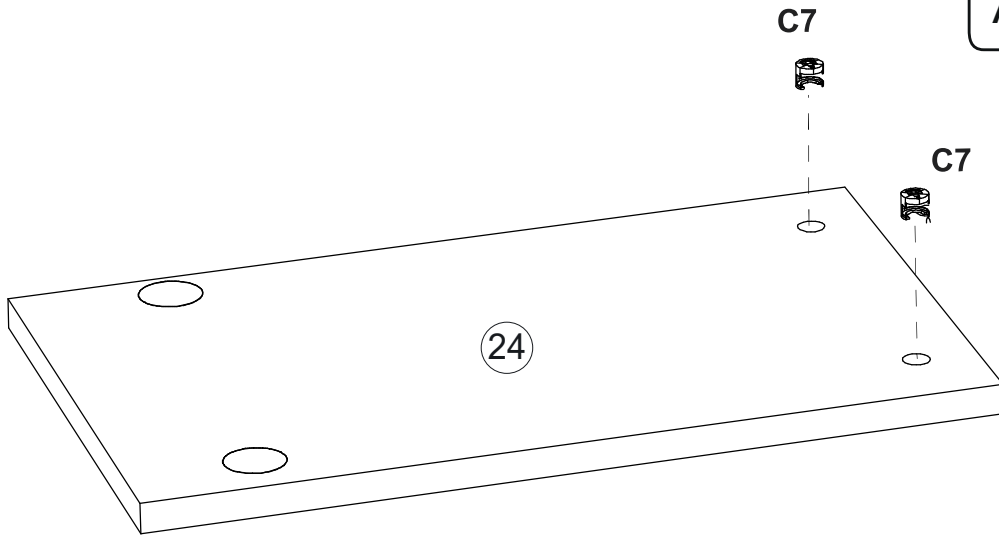



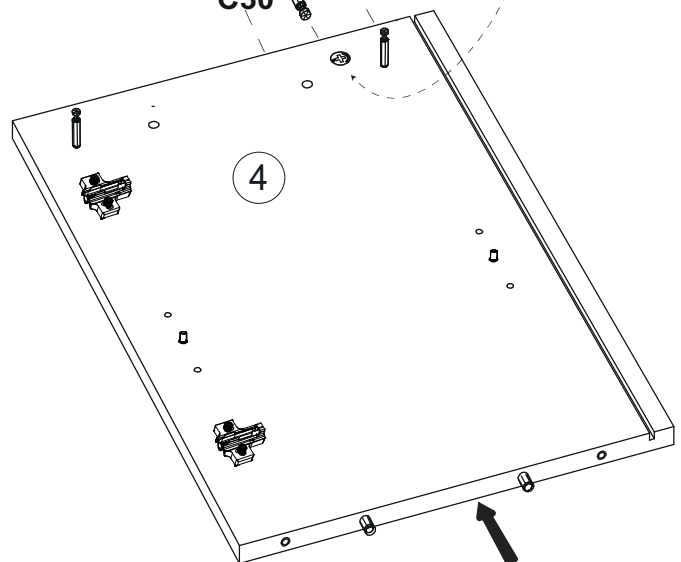
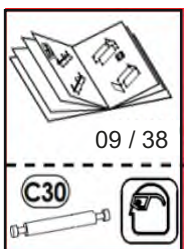
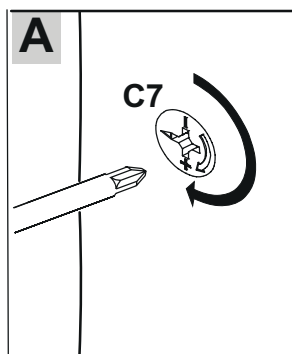
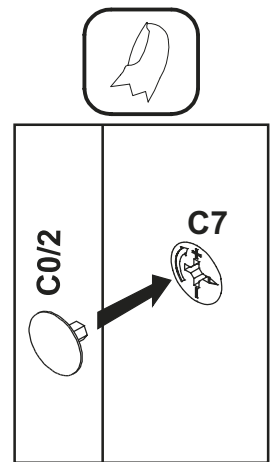
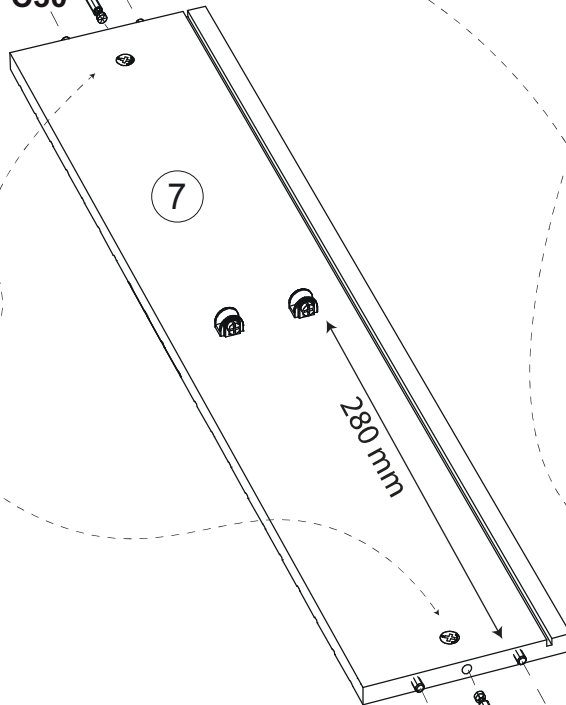
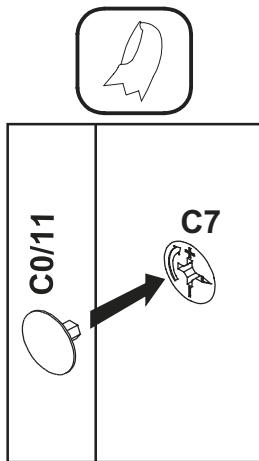
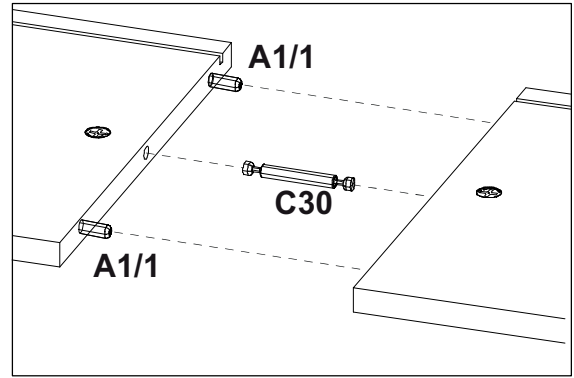
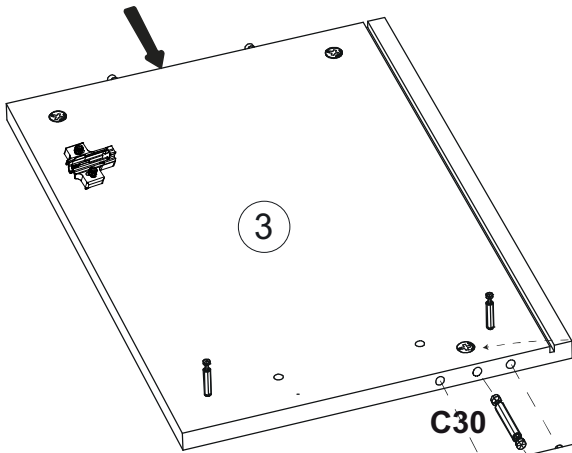

12

L-68 	anthracite / anthrazit  Ø20	oak / eiche  Ø20
C30 x2	C0/2 x2	C0/11 x2



13

		 3,5 x 16 mm	 3.5x16 mm
U1 x2	U5 x2	D36 x2	D5 x2

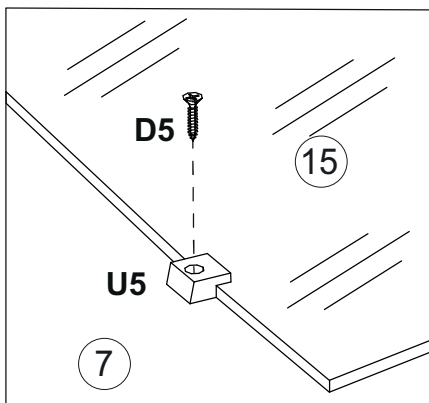
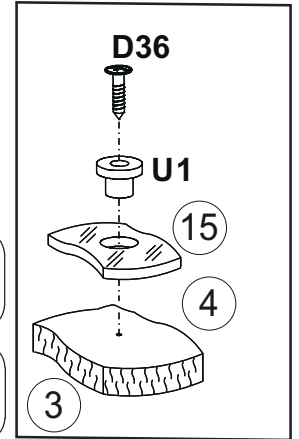
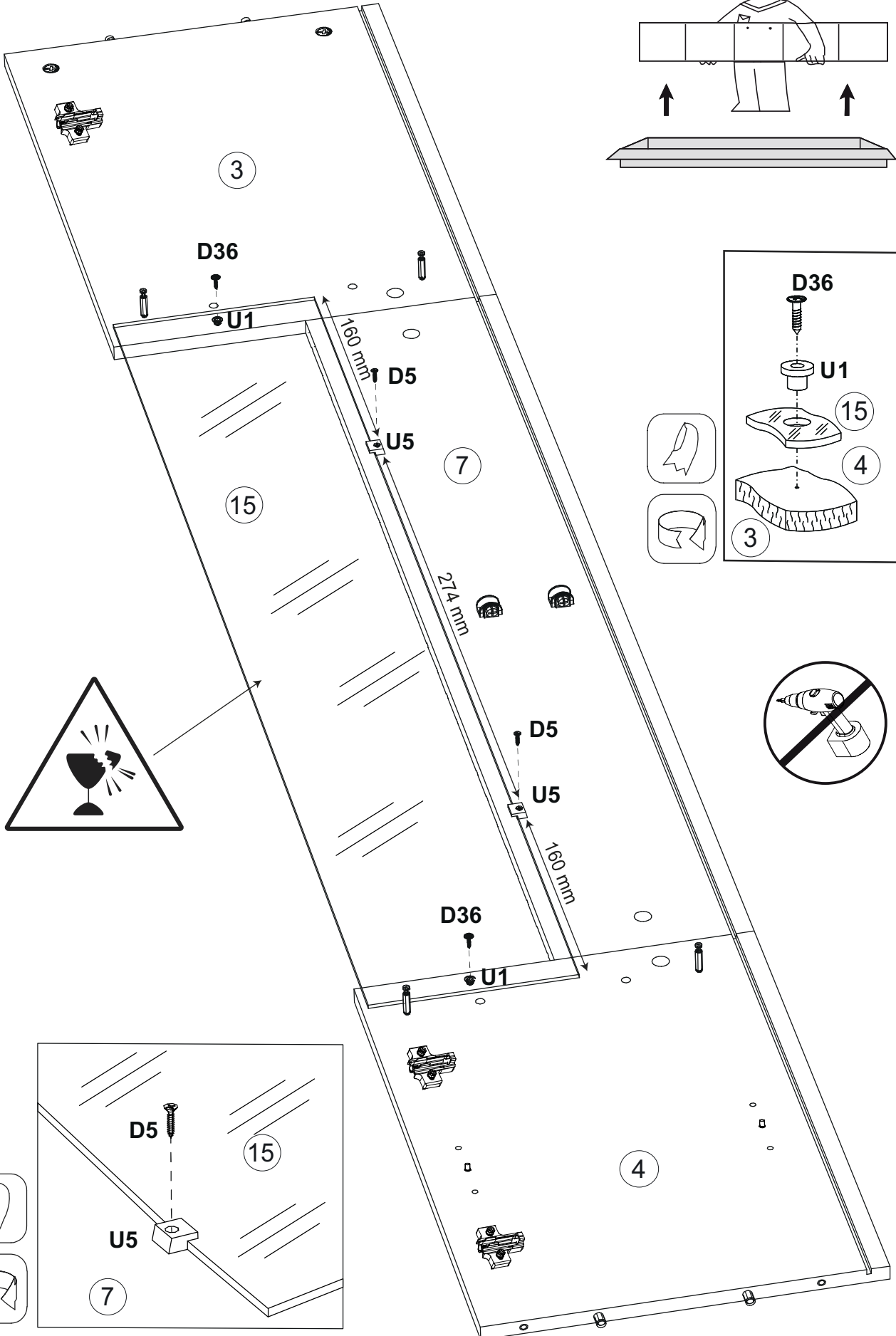
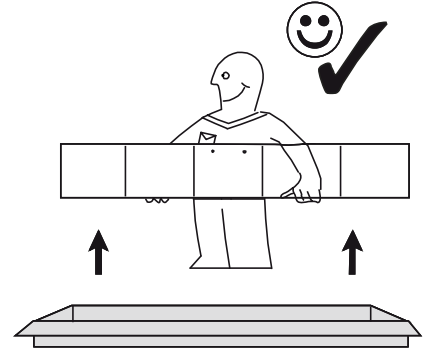



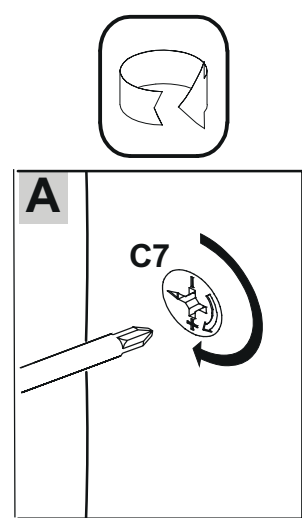
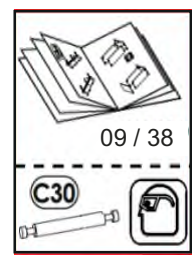
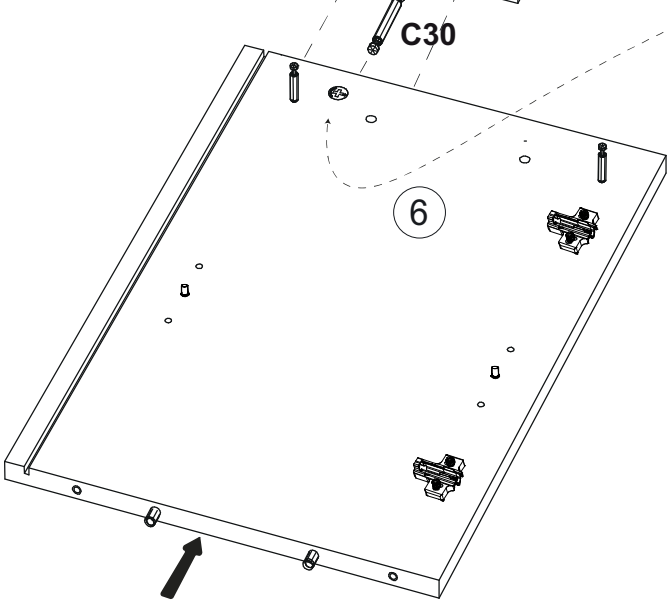
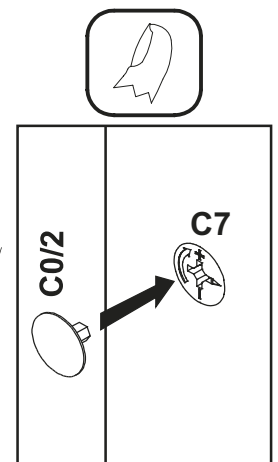
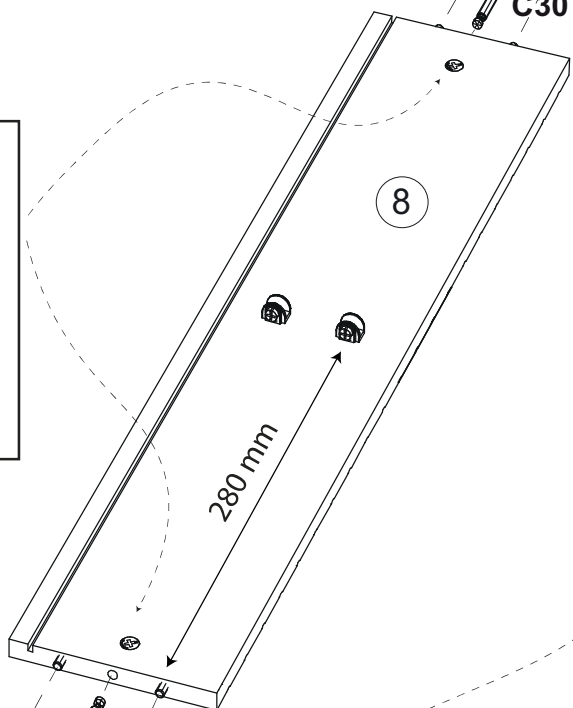
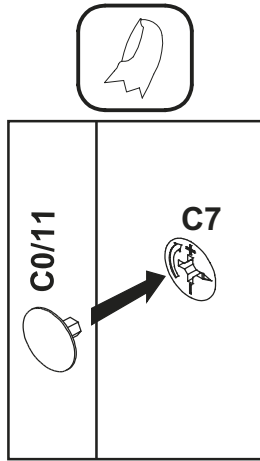
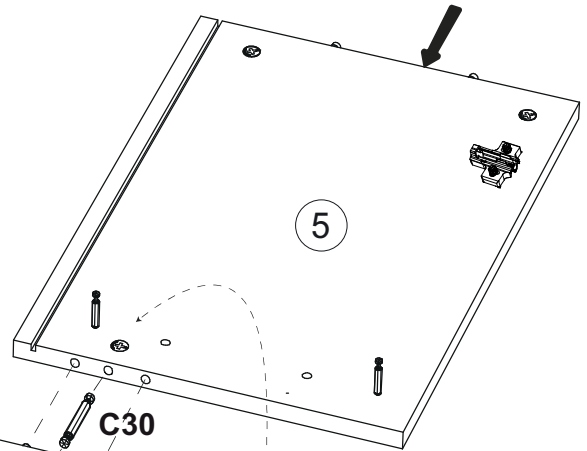
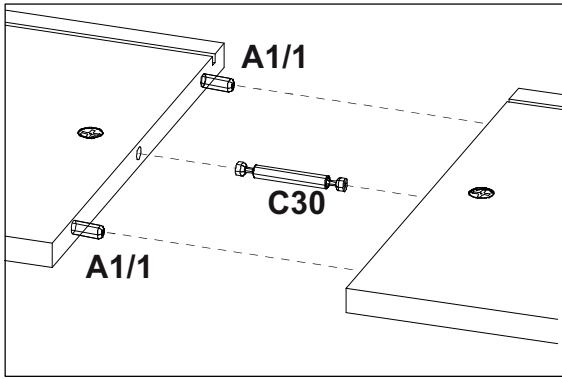

14

L-68 	anthracite / anthrazit  Ø20	oak / eiche  Ø20
C30 x2	C0/2 x2	C0/11 x2



15

		3,5 x 16 mm 	3.5x16 mm 				
U1	x2	U5	x2	D36	x2	D5	x2

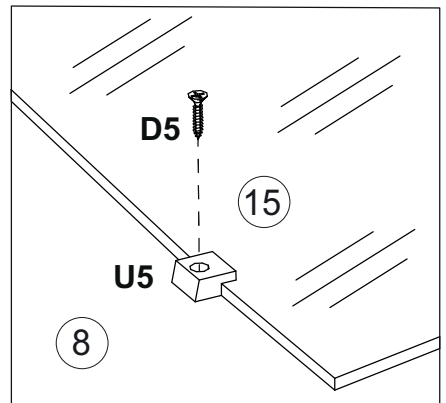
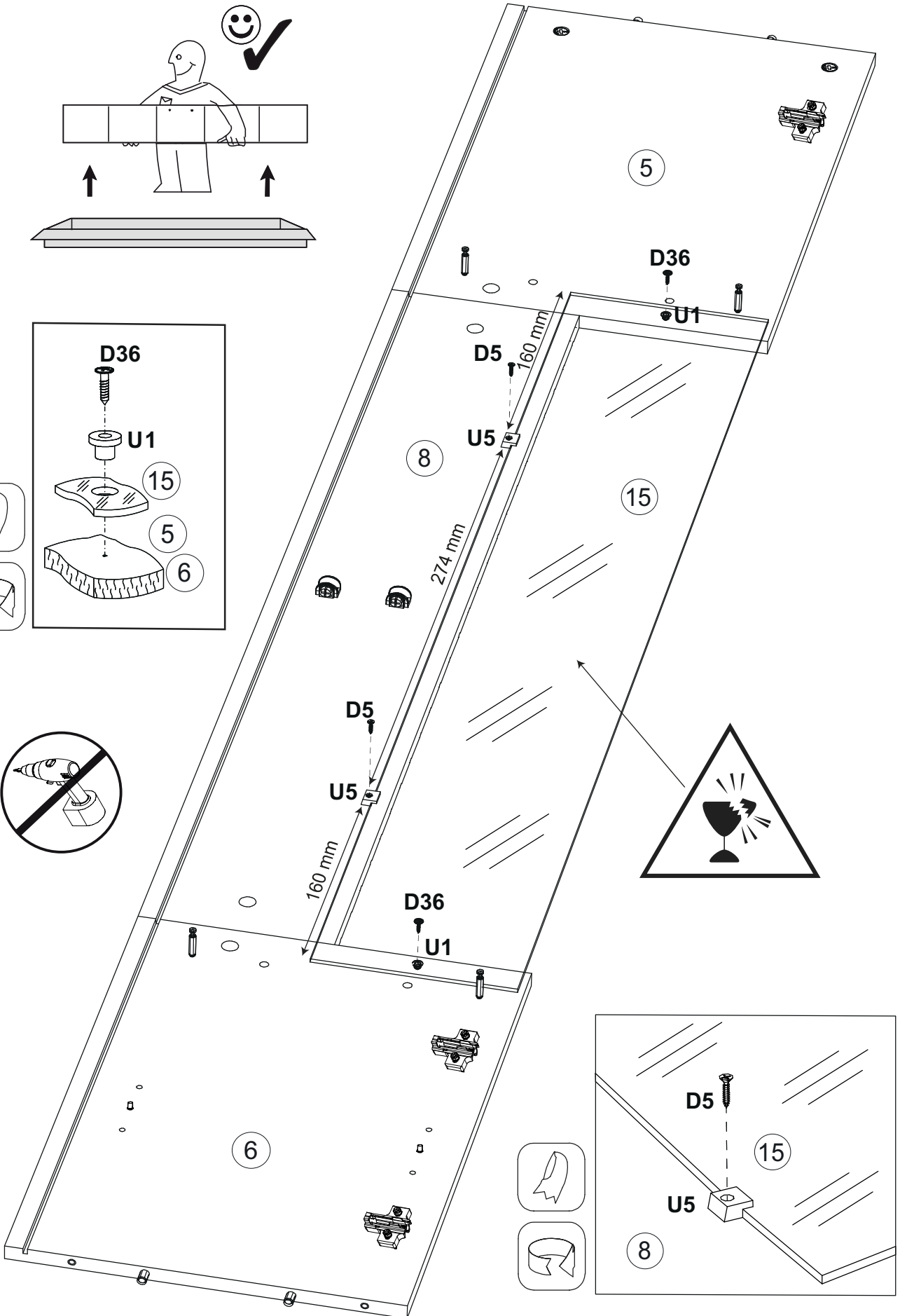
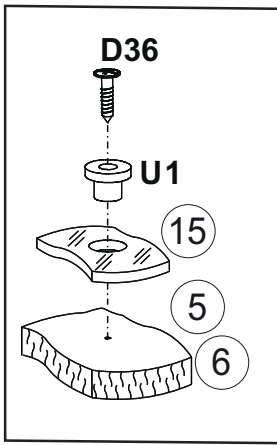
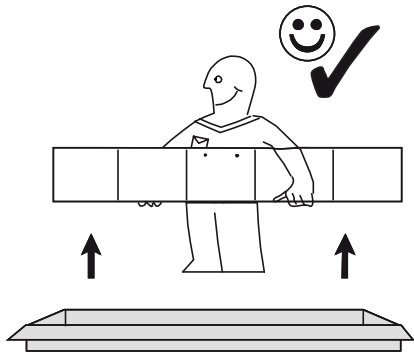

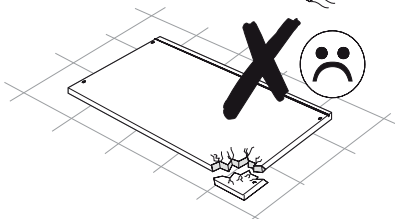
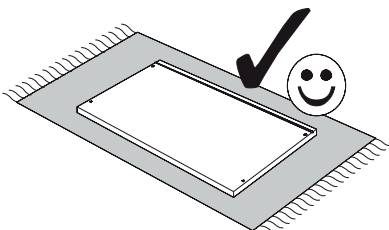
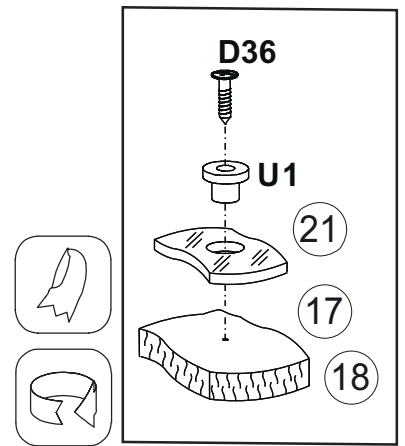
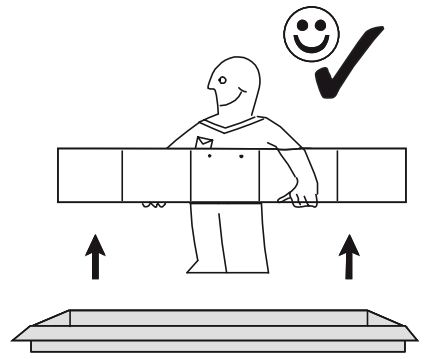
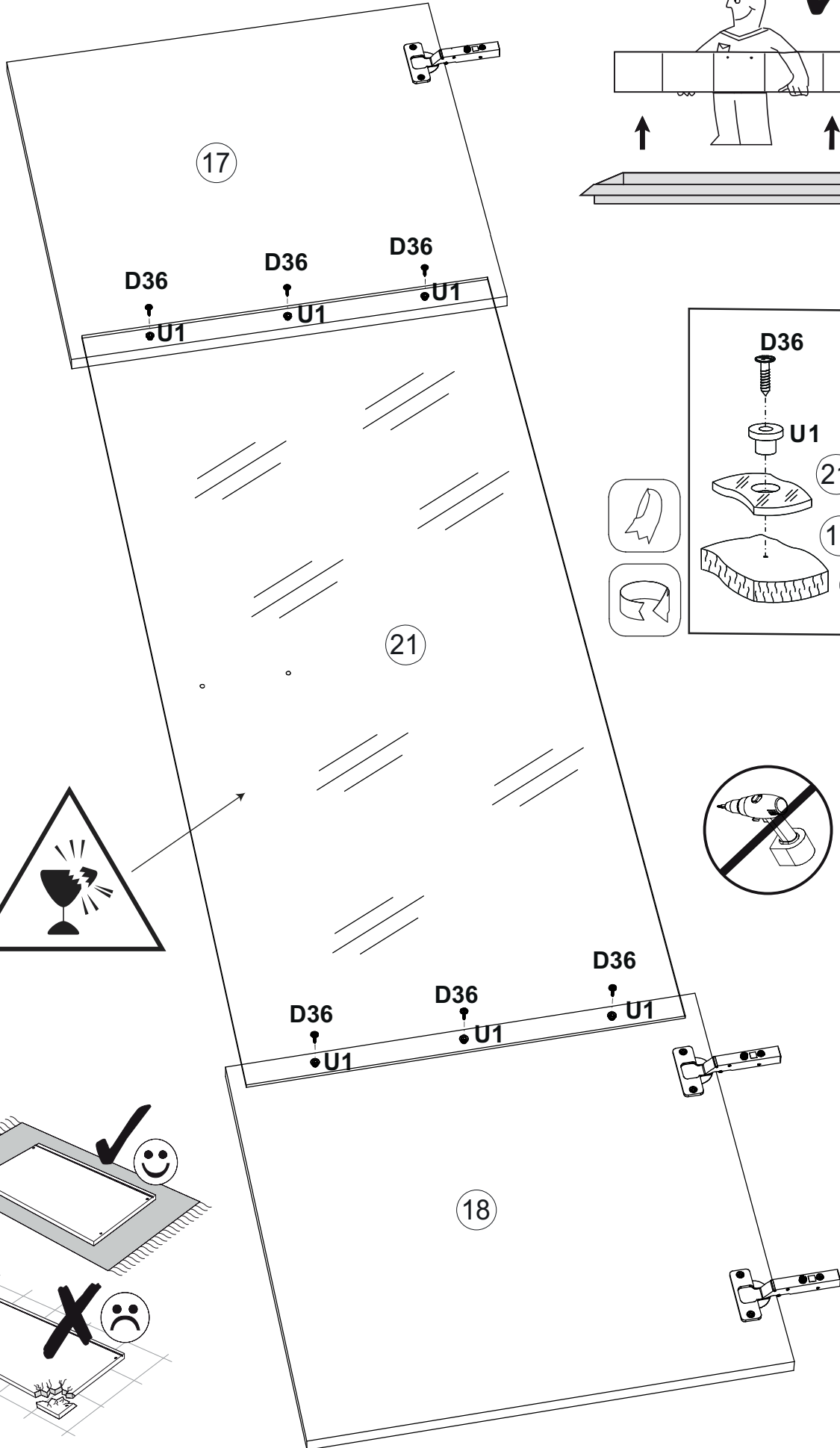

16

	3,5 x 16 mm
U1 x6	D36 x6



17

	3,5 x 16 mm
	
U1	x6
D36	x6

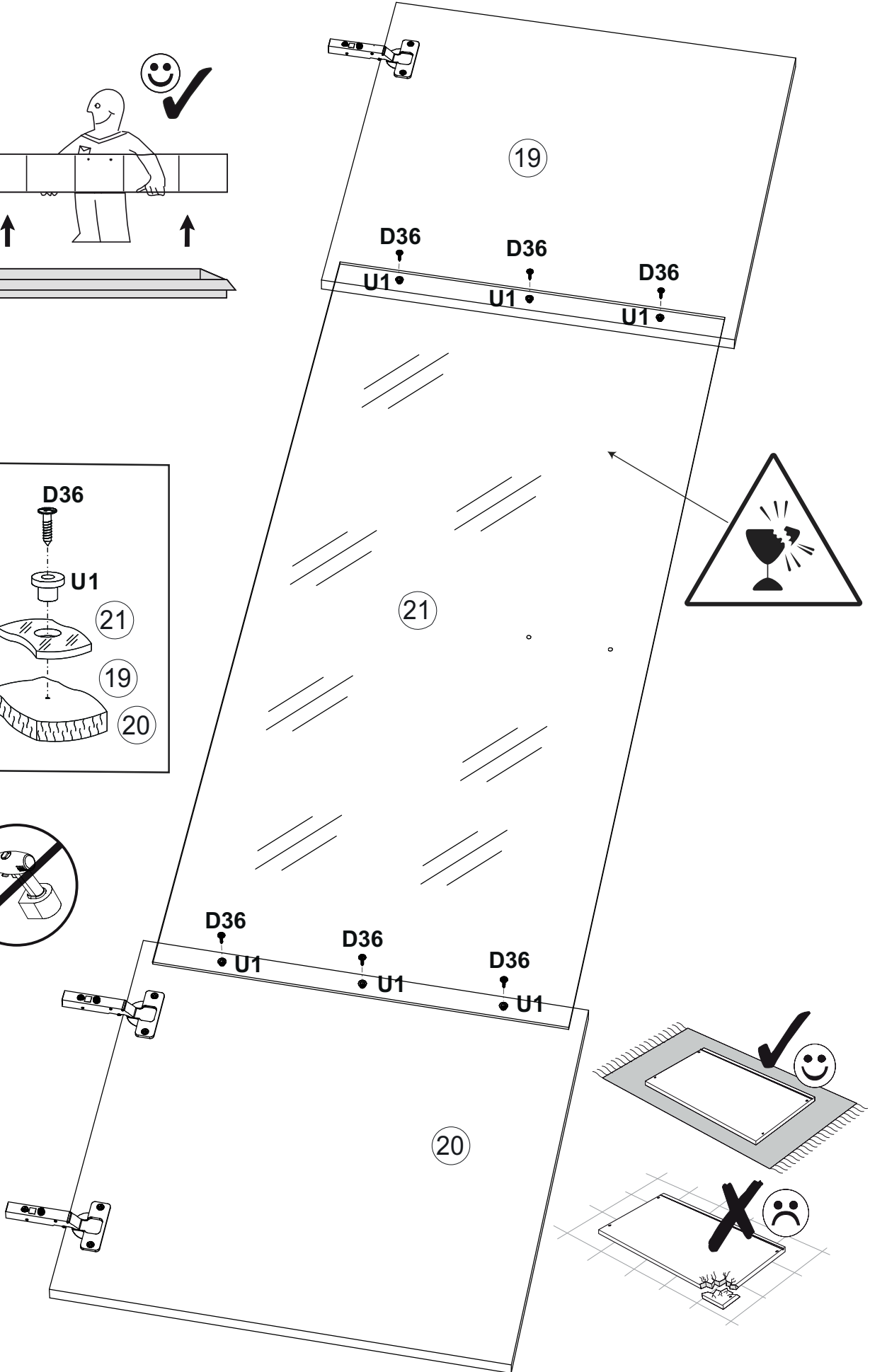
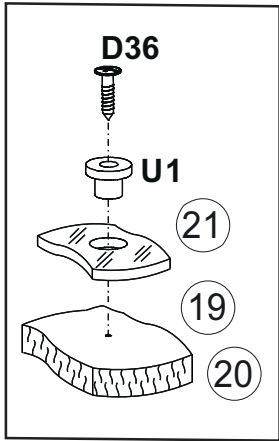
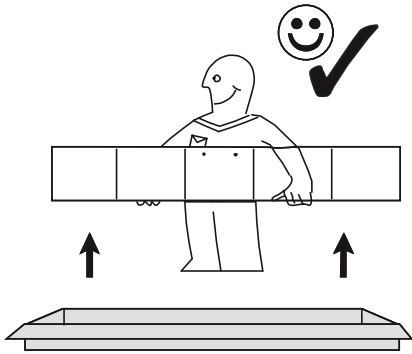

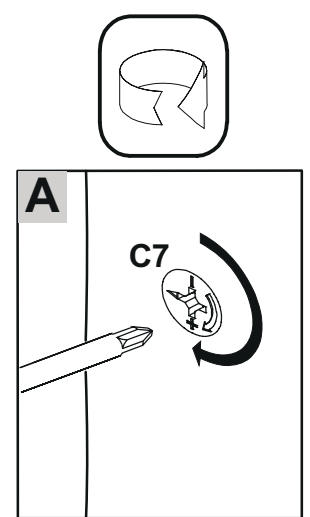
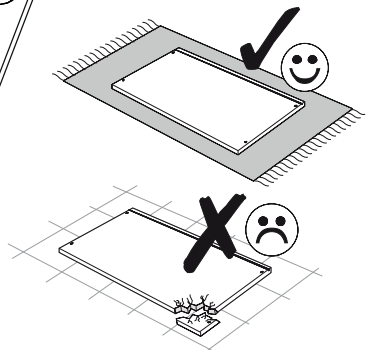
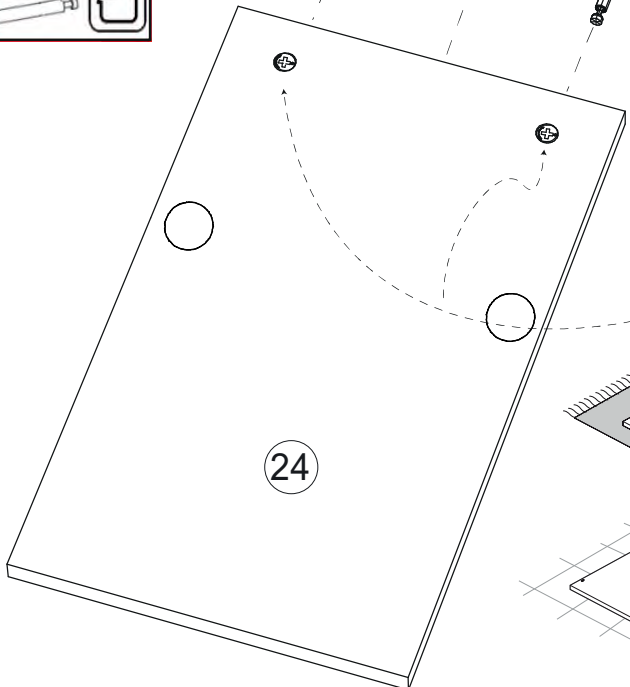
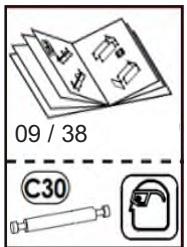
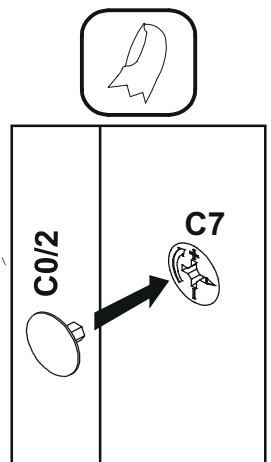
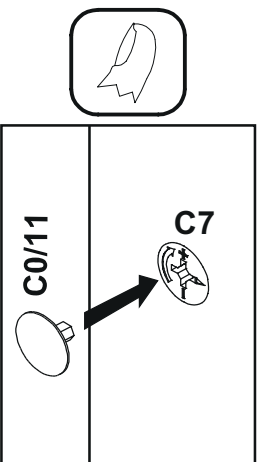
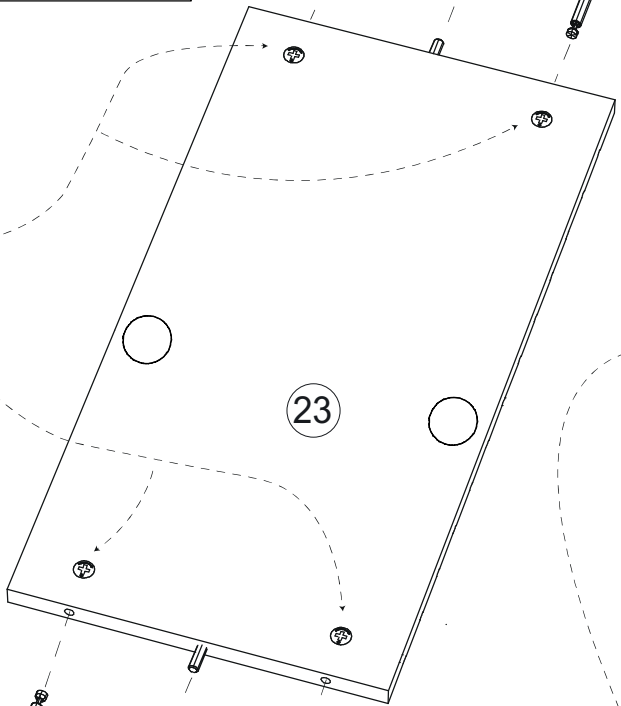
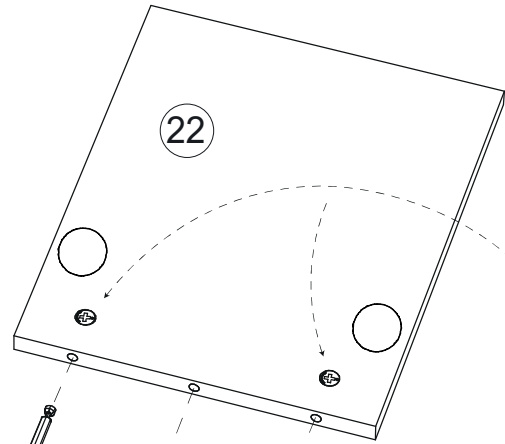
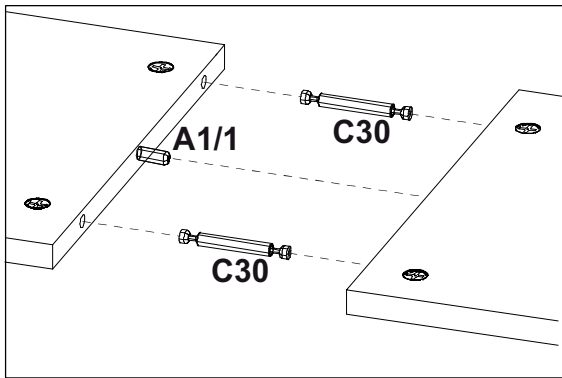

18

L-68	anthracite / anthrazit Ø20	oak / eiche Ø20
		
C30 x4	C0/2 x4	C0/11 x4

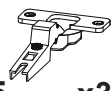

19

3.5x16 		anthracite / anthrazit Ø35 	oak / eiche Ø35 
D5 x6	J5 x3	J0/1 x2	J0/2 x1

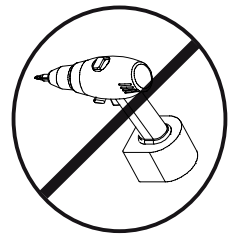

«R»

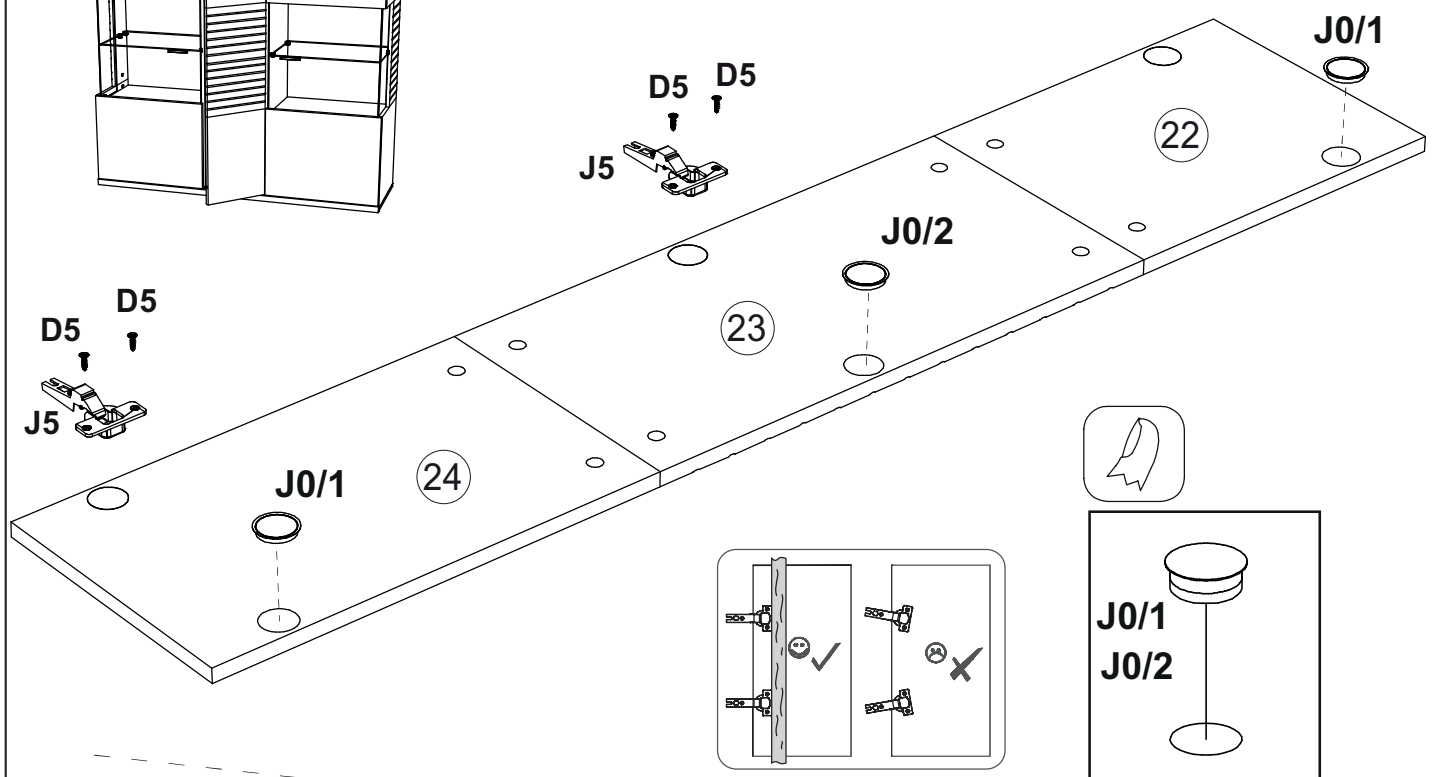
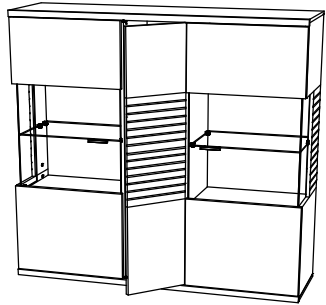

«L»

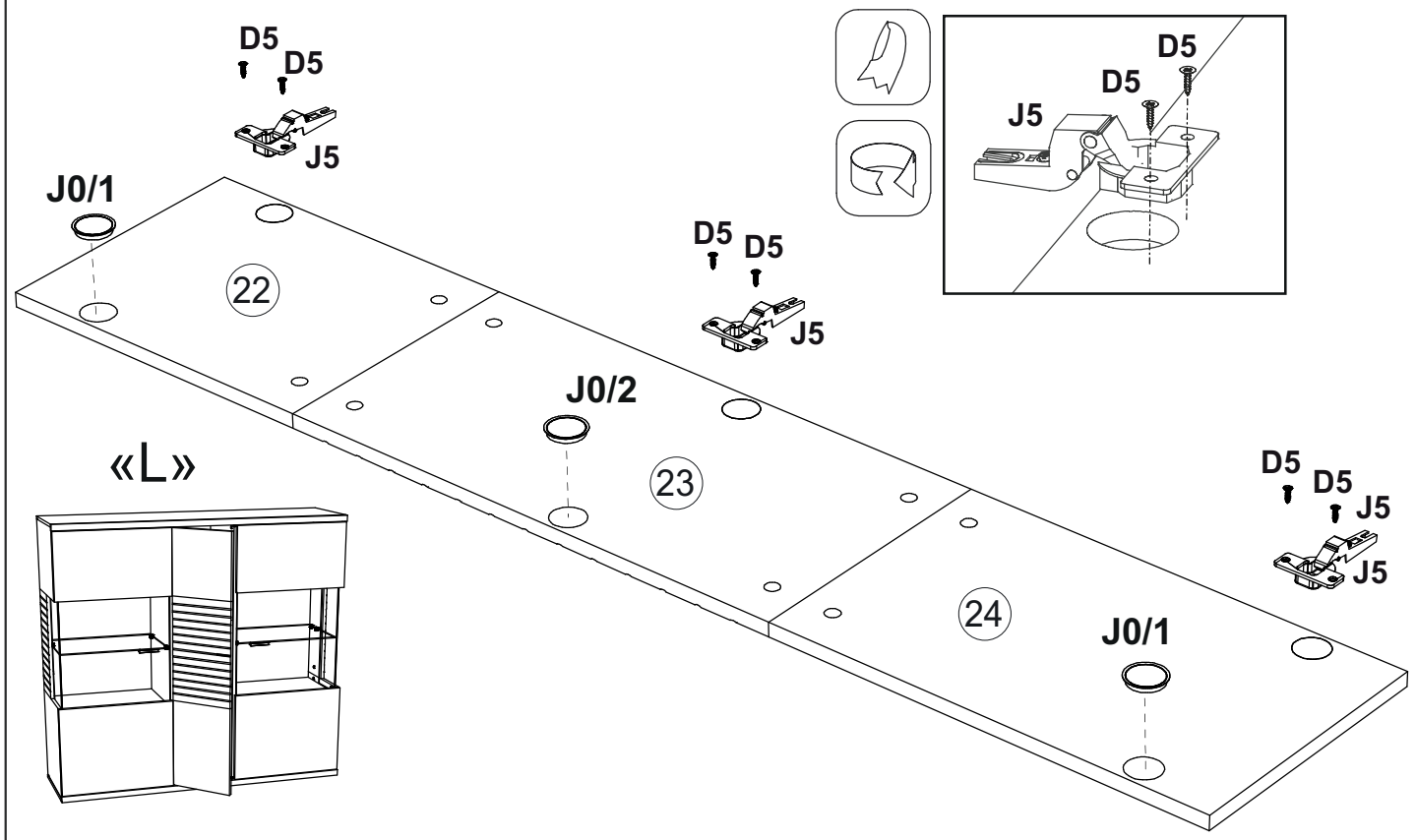
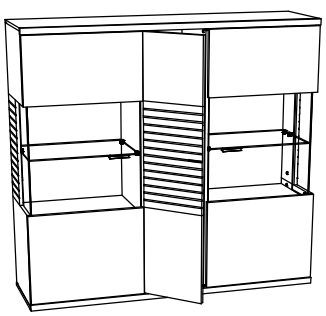

20

anthracite / anthrazit
Ø20
C0/2 x8

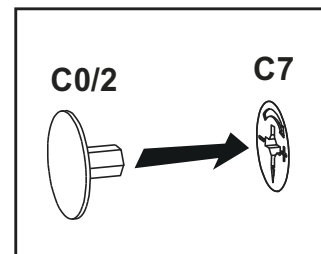
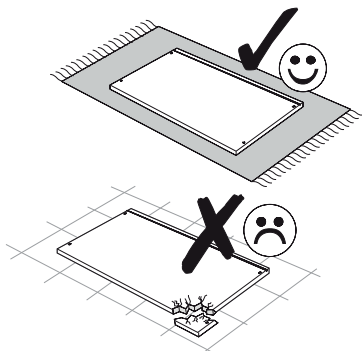
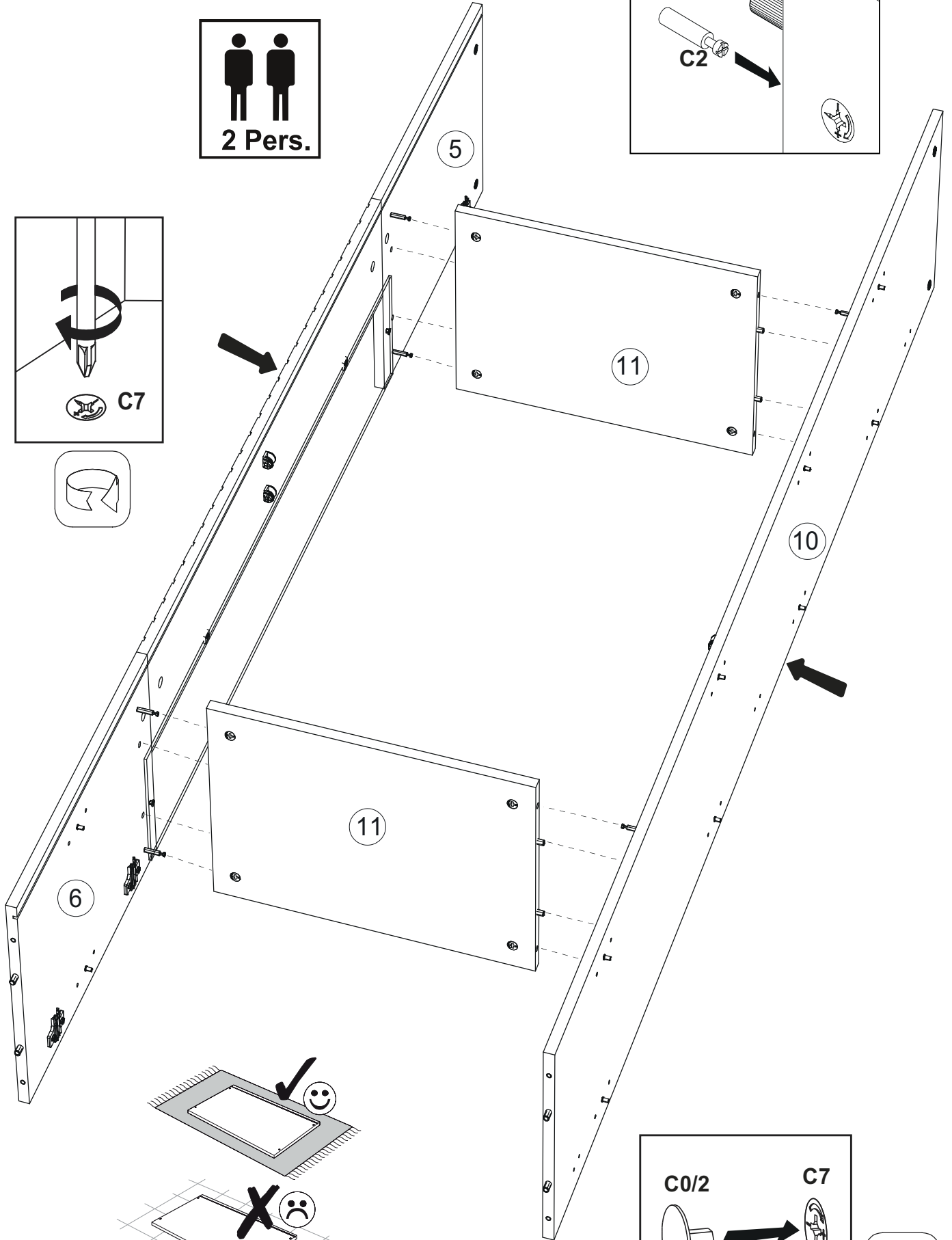
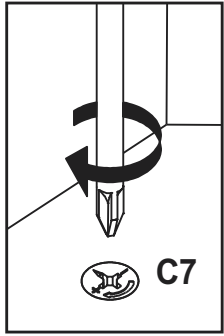
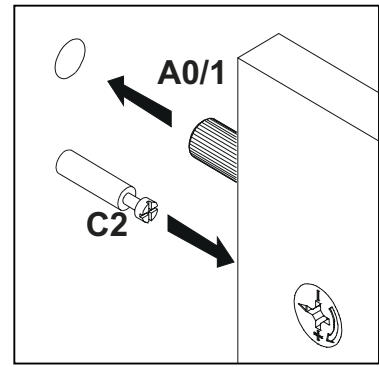
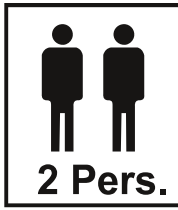

21

anthracite / anthrazit
Ø20
C0/2 x8

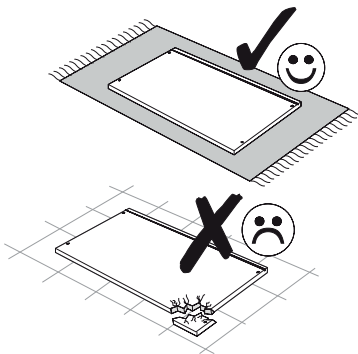
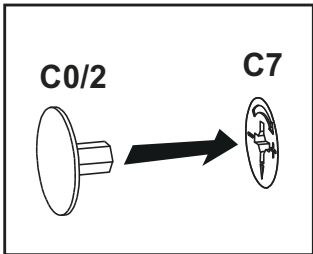
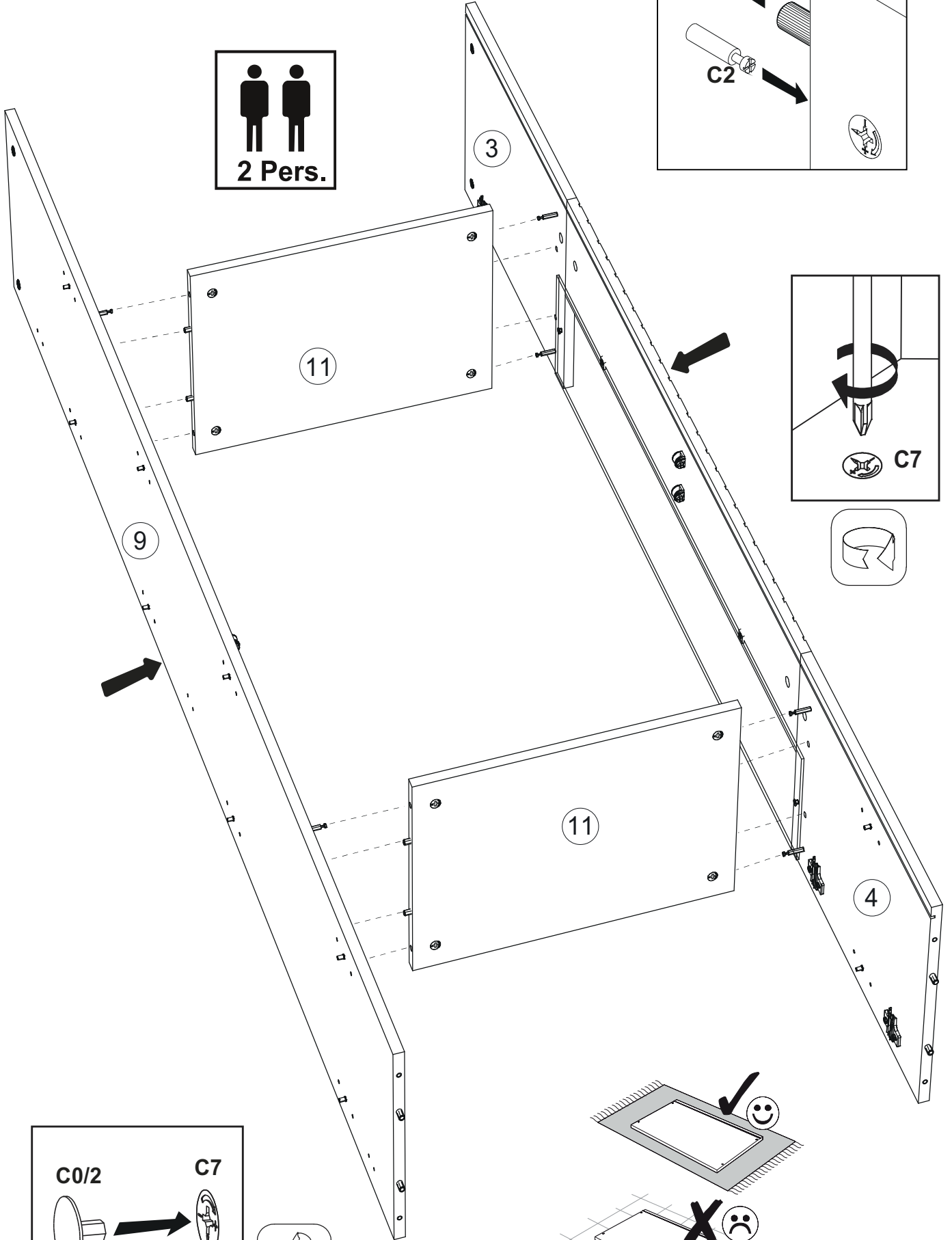
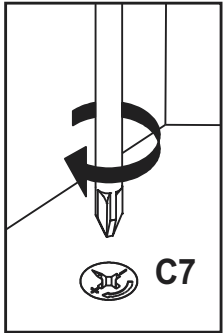
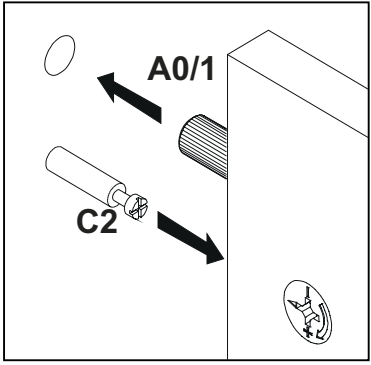

22

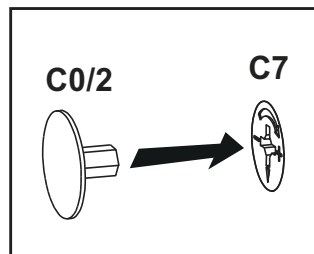
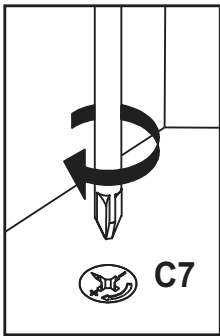
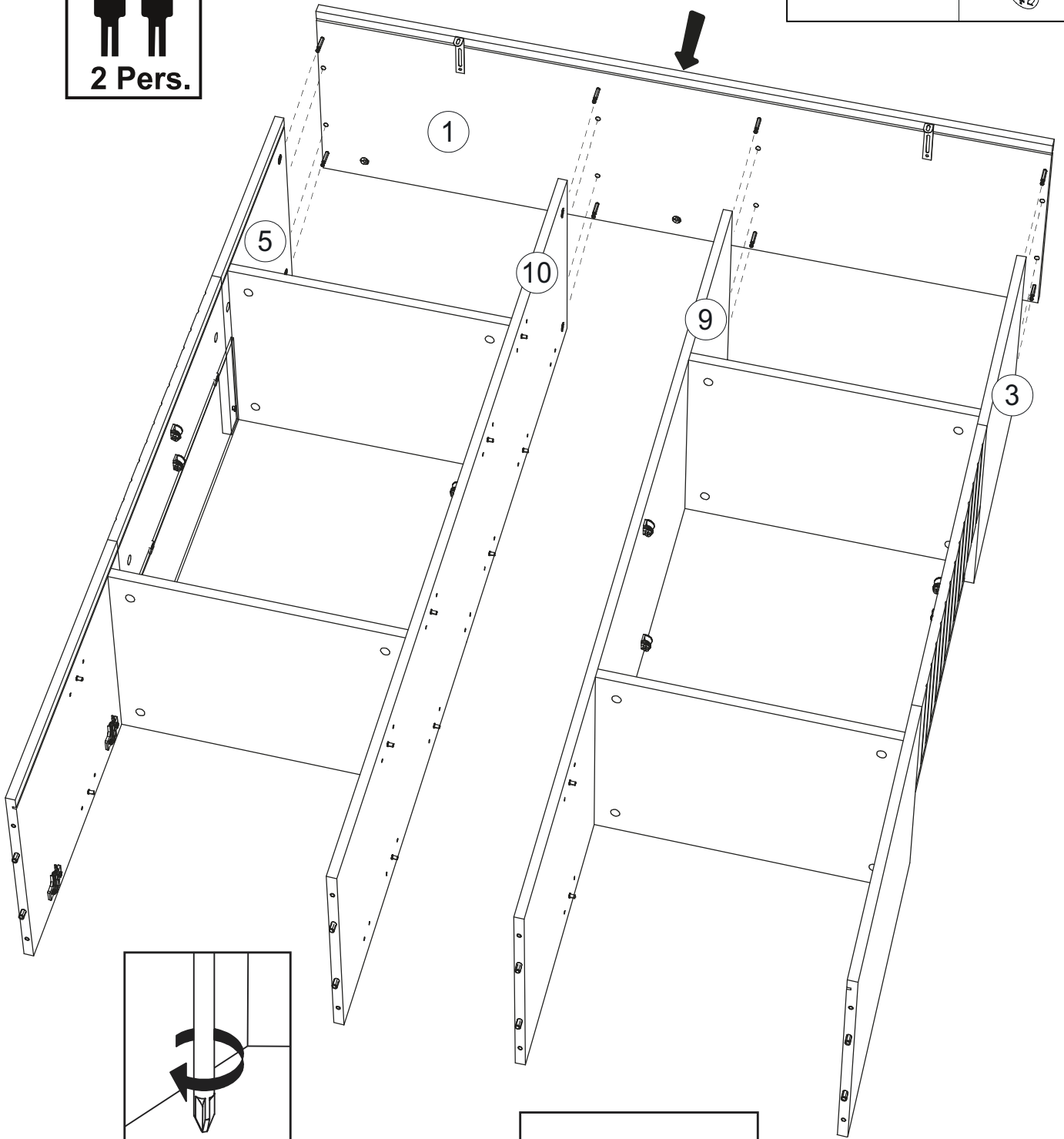
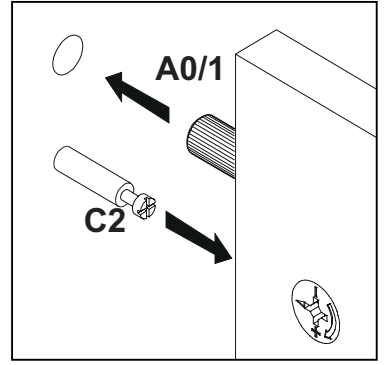

anthracite / anthrazit
Ø20
C0/2 x8

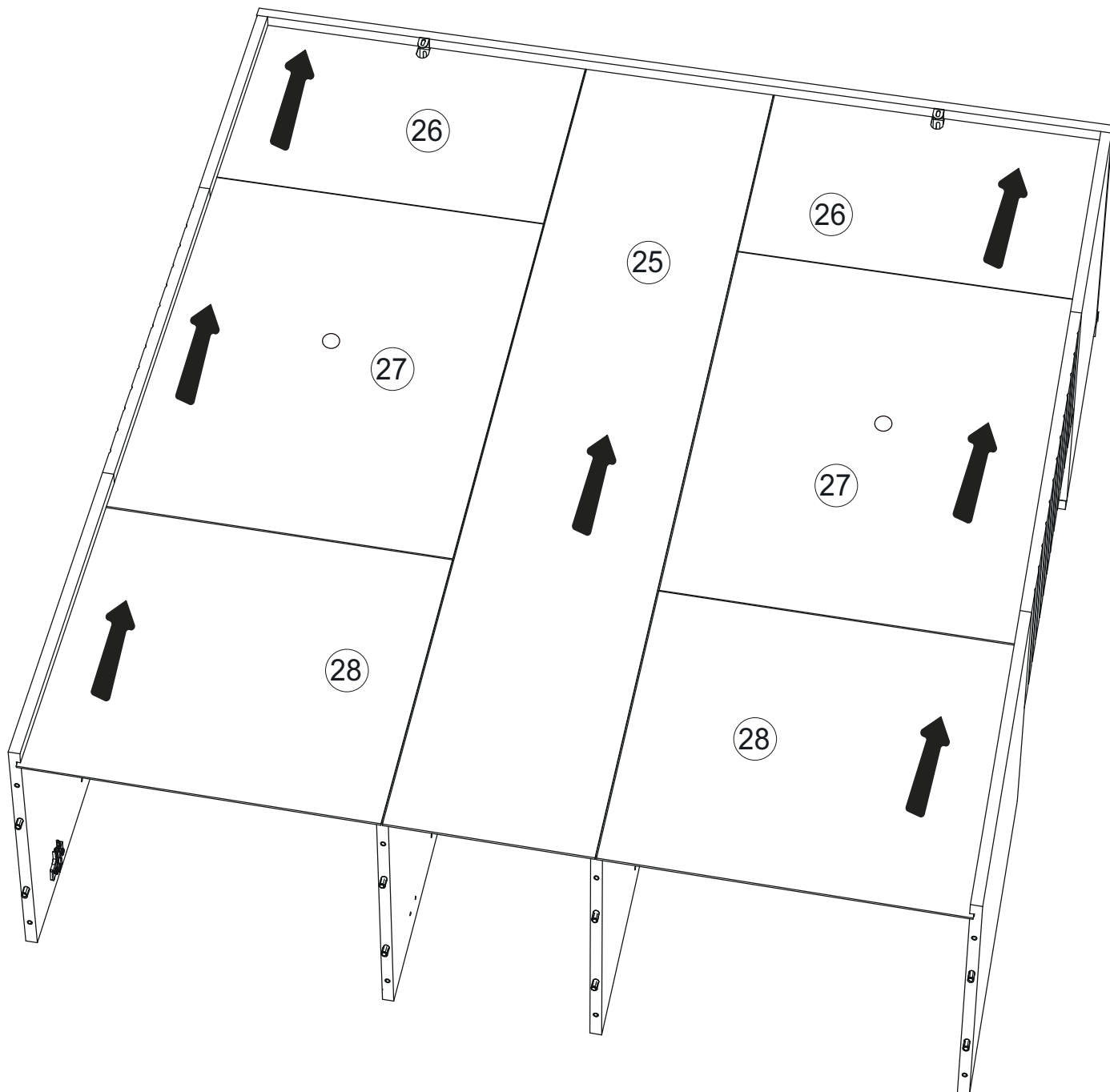
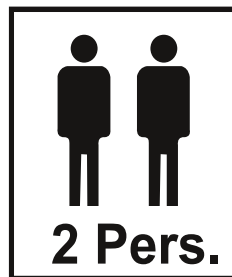

23



24

 B1	x8	 K	x1	 oak / eiche Ø13	B0/10	x8
---	----	--	----	---	-------	----

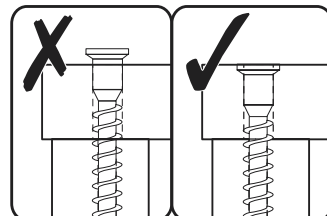
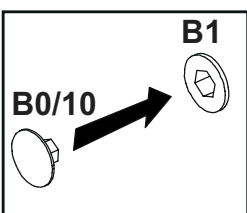
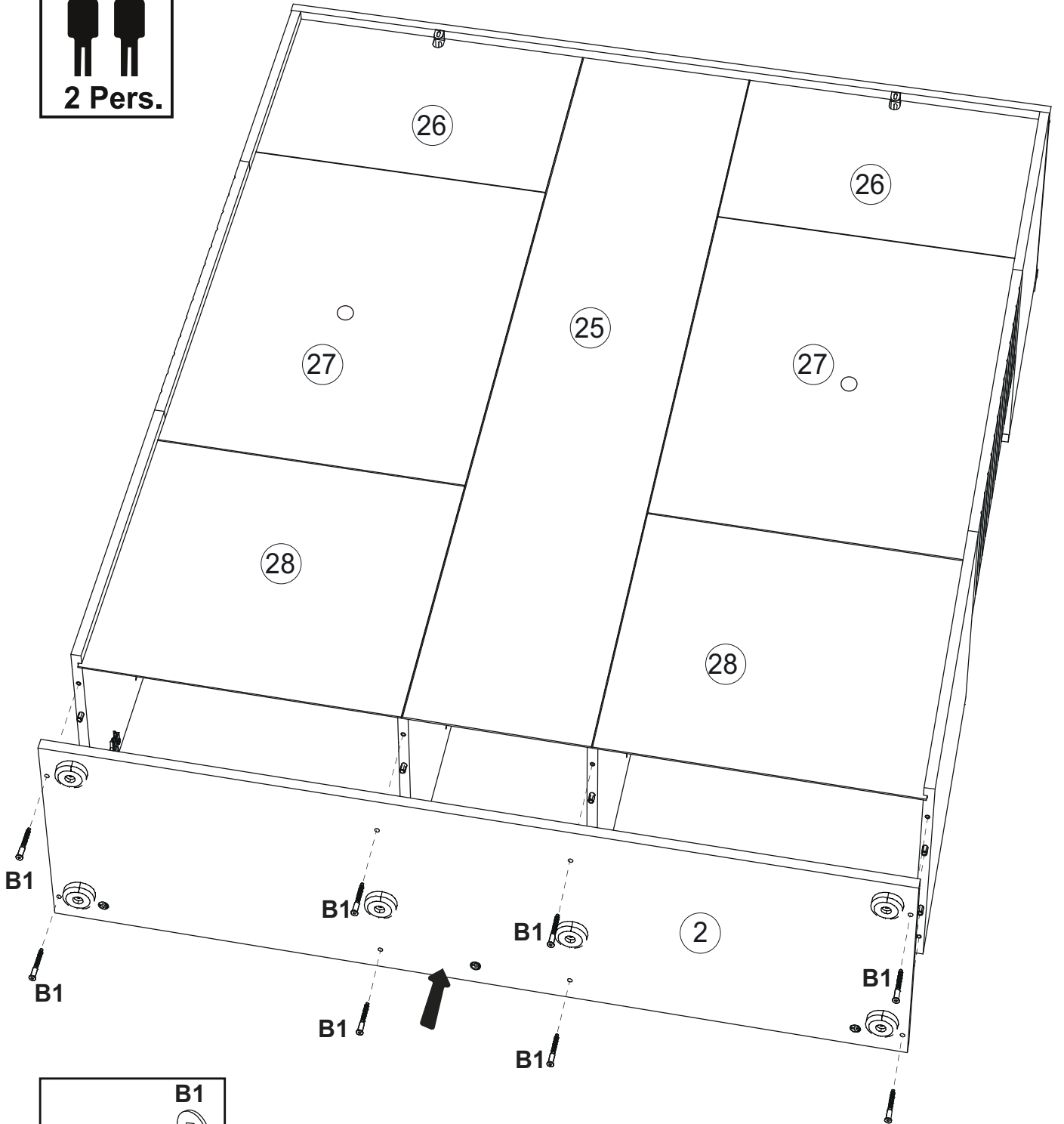
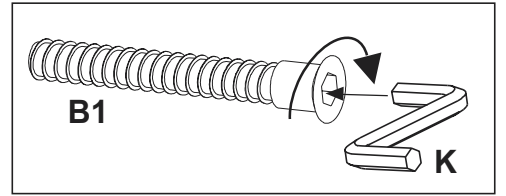

25

3.5x16



D5 x42



M1 x24



M3 x18

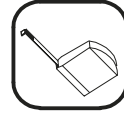
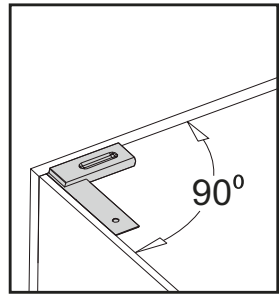

A=B

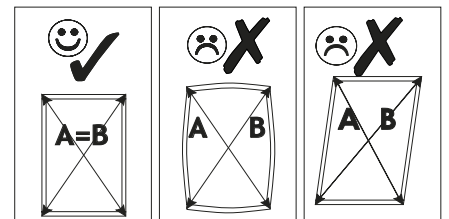
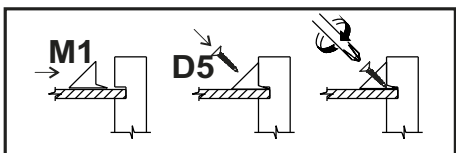
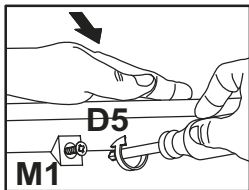
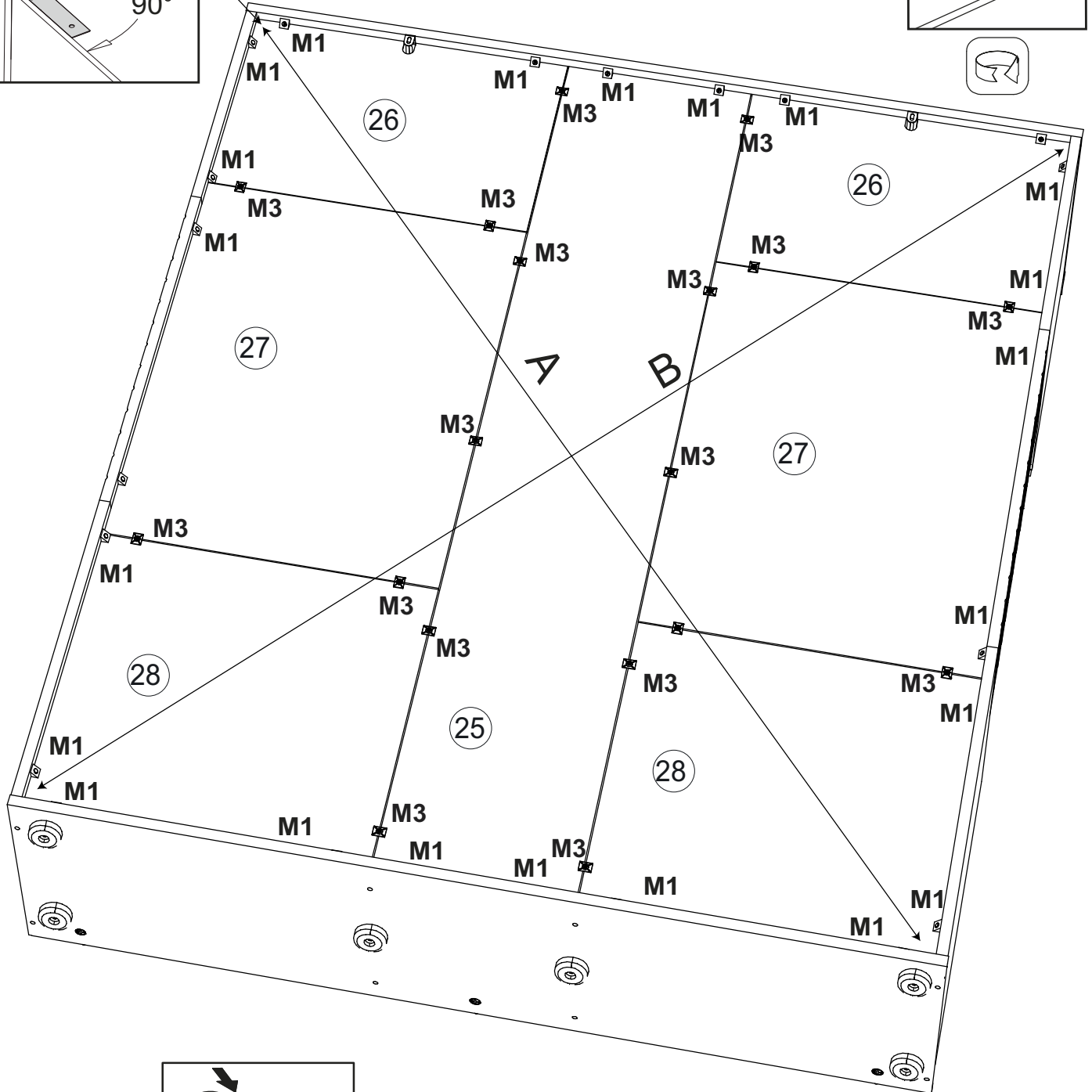
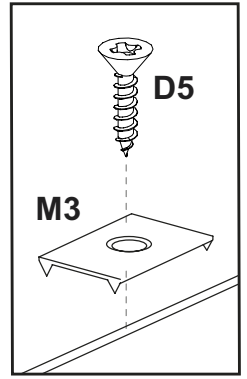

26

oak / eiche
Ø20
C0/11 x6

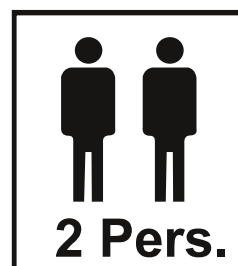
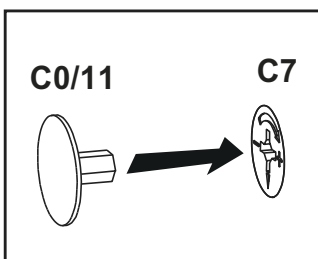
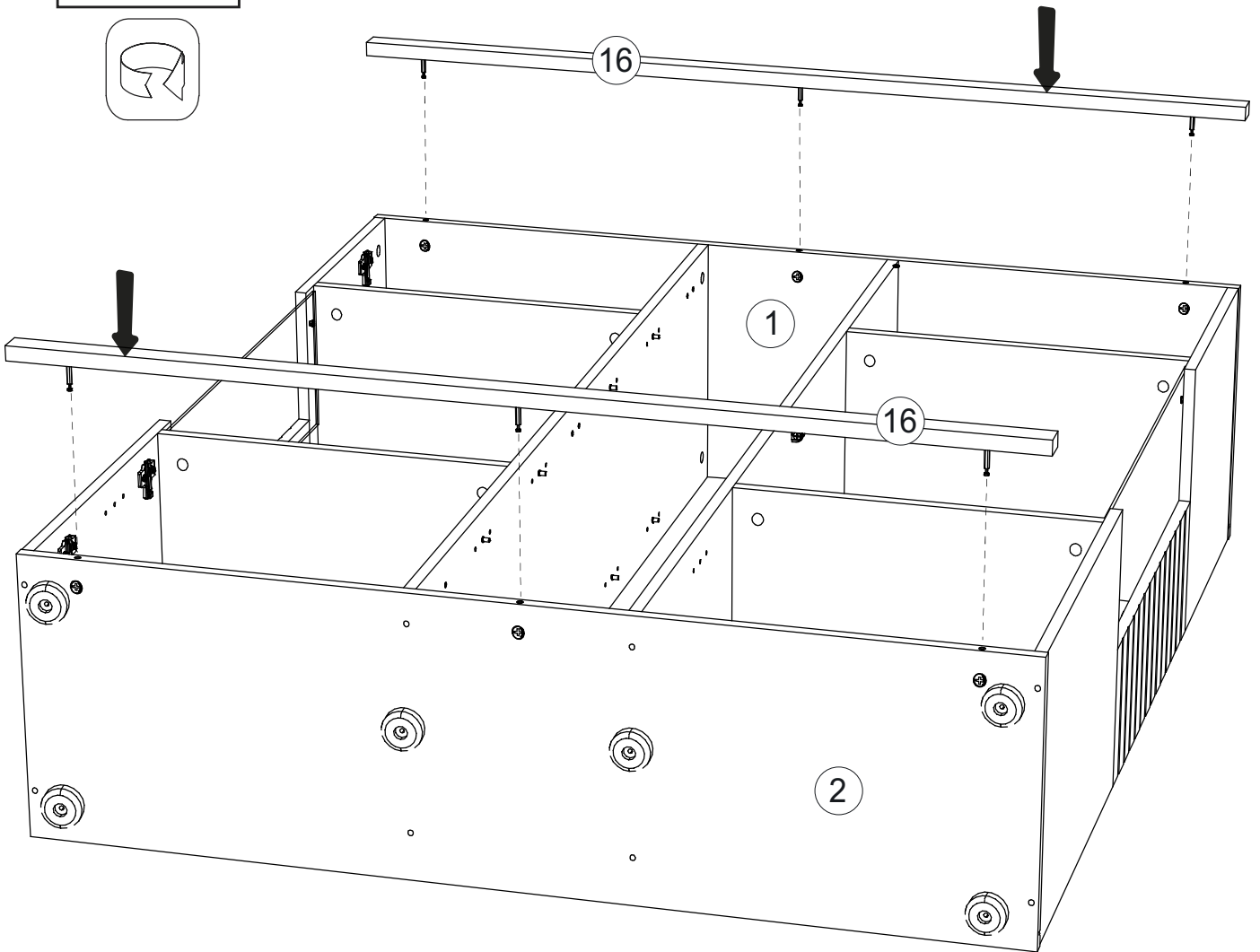
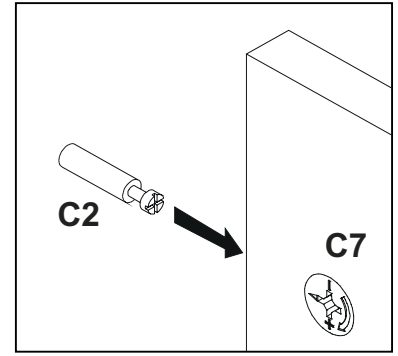
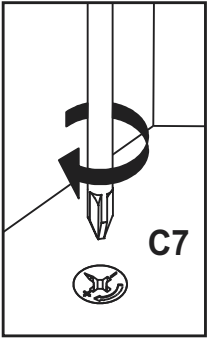

27

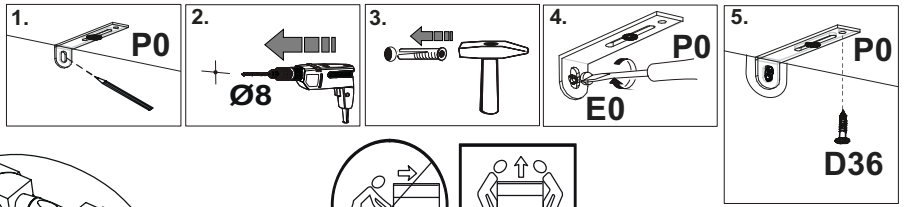
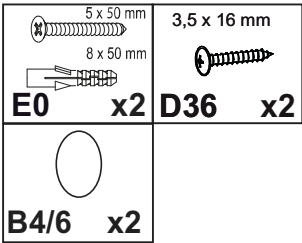

261 mm

788 mm

261 mm

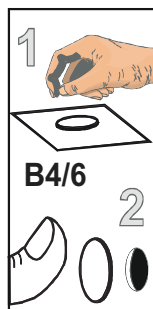
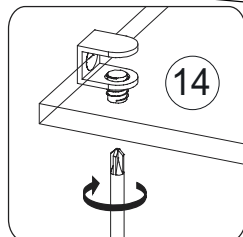
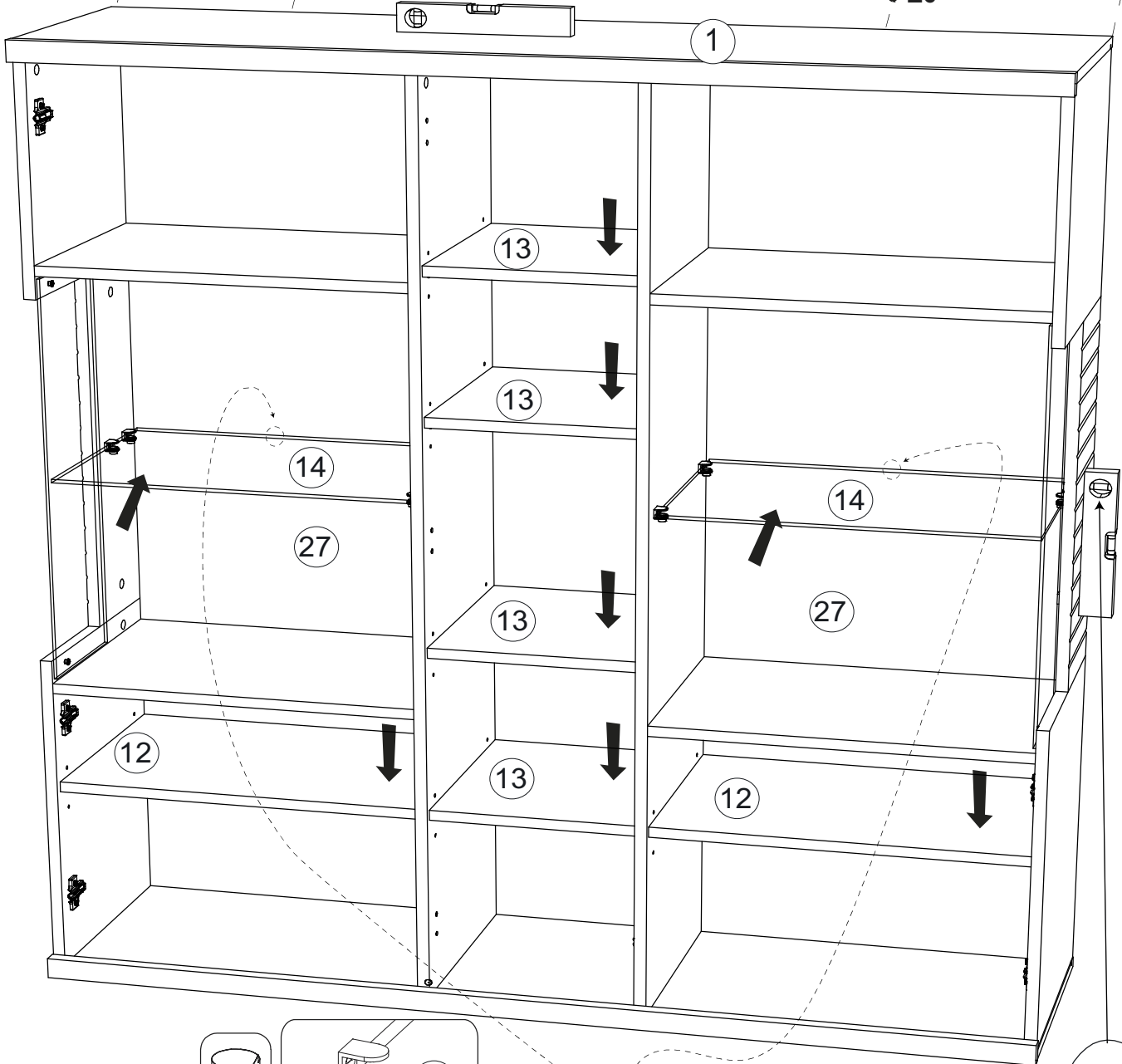

**Optional !
LED**

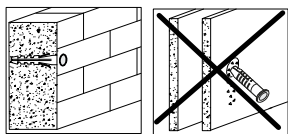
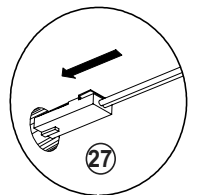
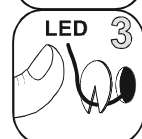

28

anthracite / anthrazit
Ø5
C22/7 x6 J6 x3

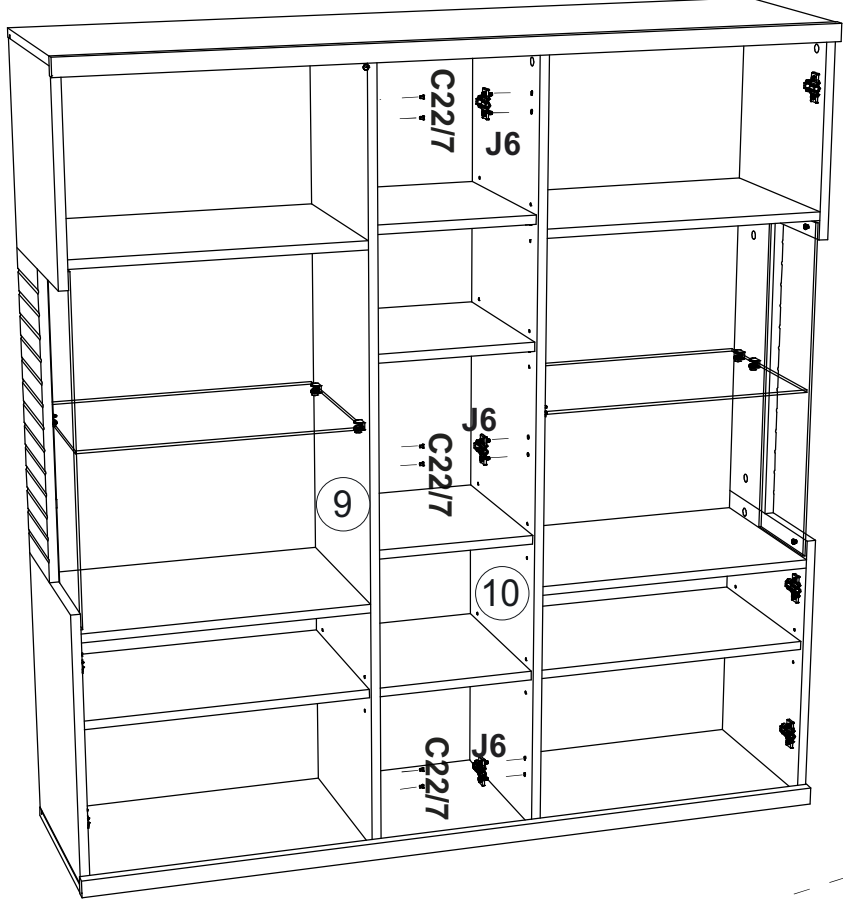
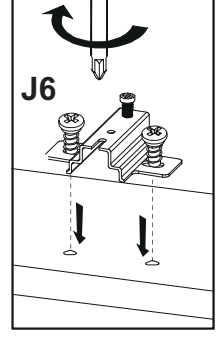

«R»

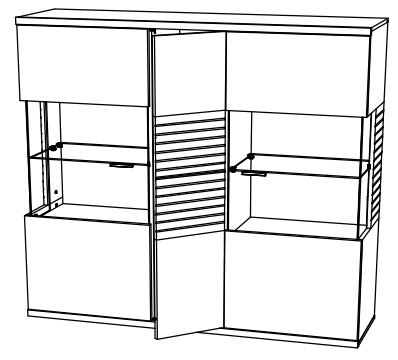

«L»

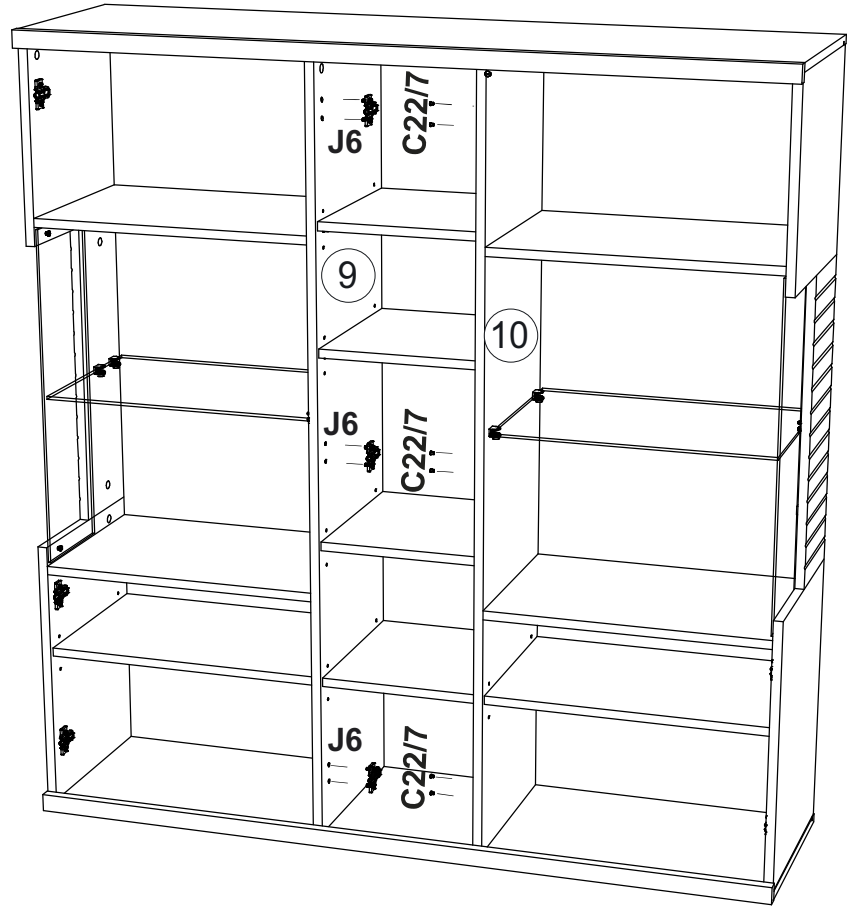
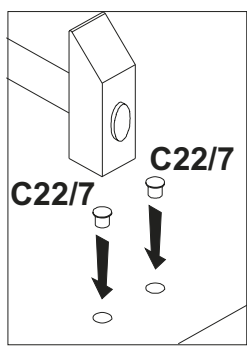
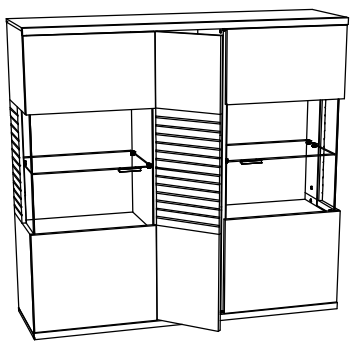

29

3.5x16

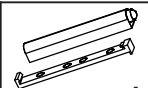
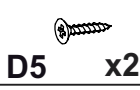

D5 x2

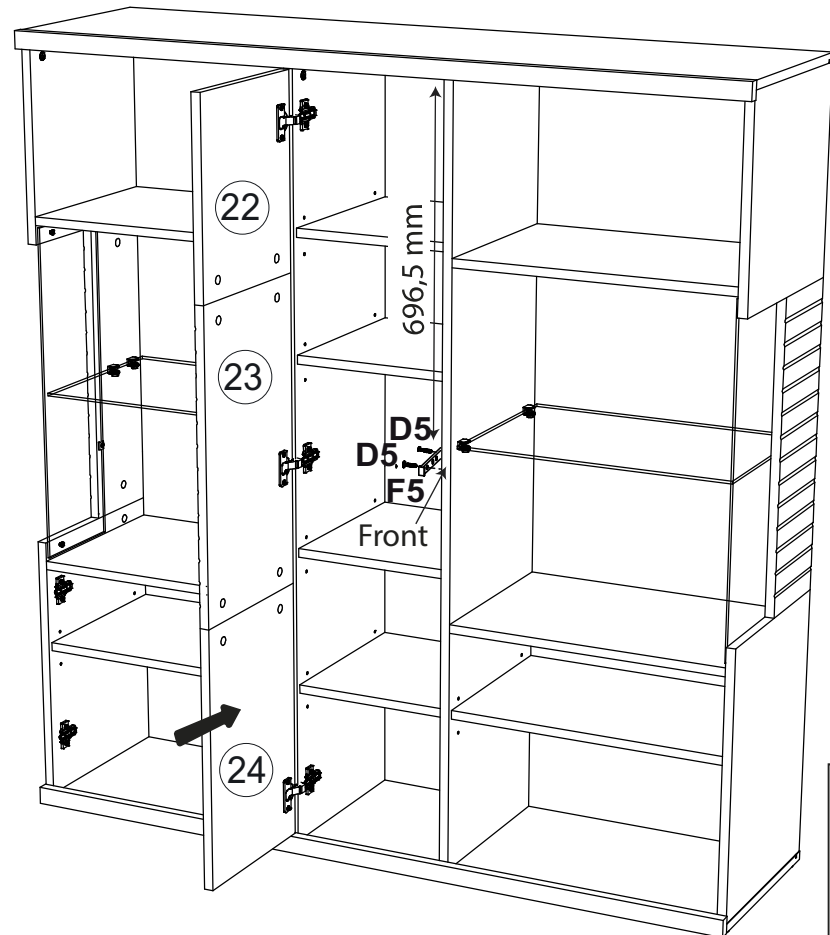
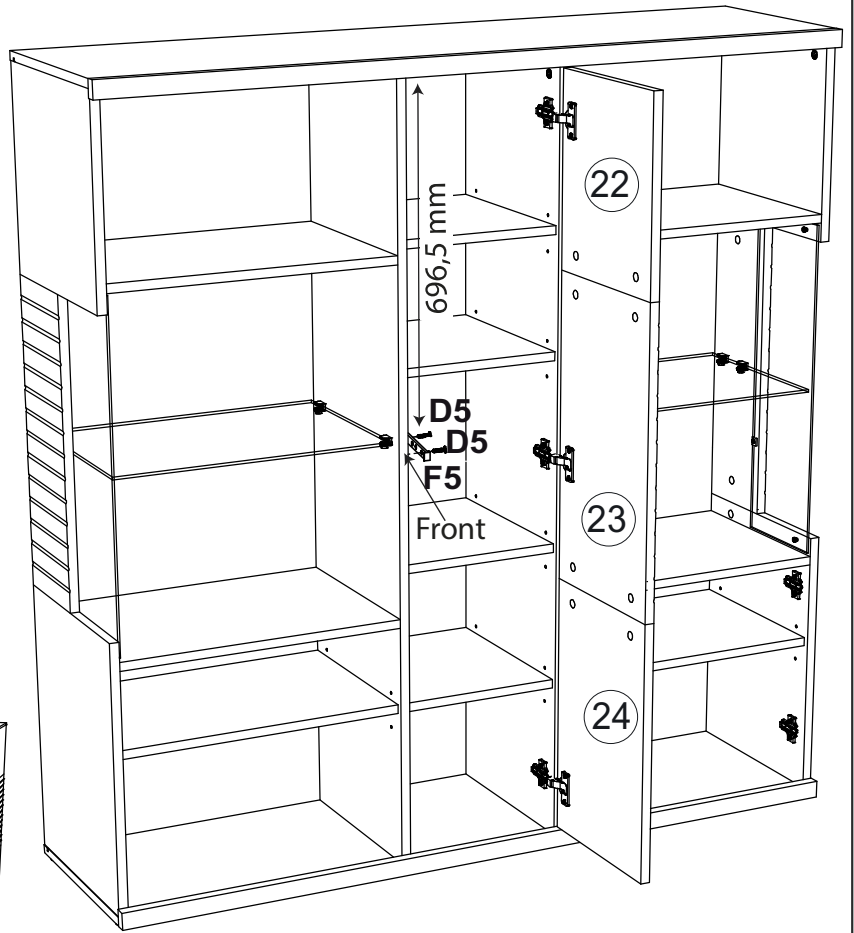
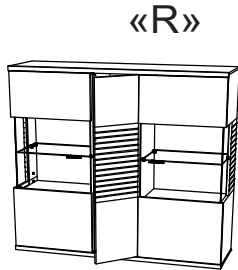
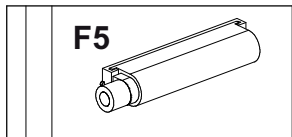
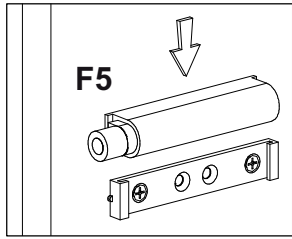
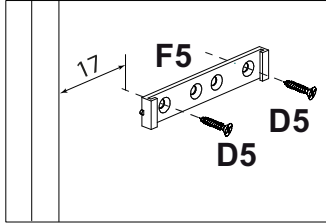
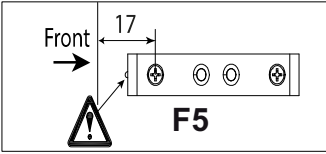

F5 x1

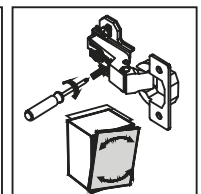
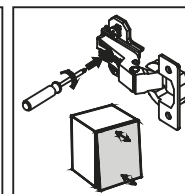
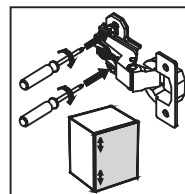
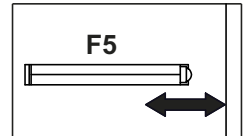
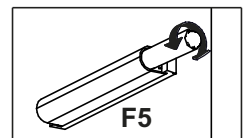
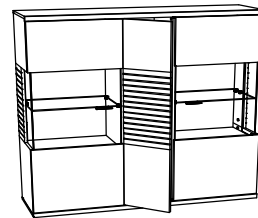

«L»

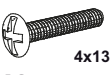

30

-  U1 x4
-  L166 x2
-  H8 4x13 x4

