

EARL
8112/2500/8142
8141/2500/8312

- | | | | |
|-----------|--|-----------|---|
| D | MONTAGEANLEITUNG
BEDIENUNGSANLEITUNG | GB | ASSEMBLY INSTRUCTIONS
INSTRUCTION MANUAL |
| NL | HANDLEIDING VOOR DE MONTAGE
GEBRUIKSAANWIJZING | PL | INSTRUKCJA MONTAŻU
INSTRUKCJA OBSŁUGI |
| TR | MONTAJ TALIMATI
KULLANIM KLAVUZU | RU | ИНСТРУКЦИЯ ПО МОНТАЖУ
ИНСТРУКЦИЯ ПО ЭКСПЛУАТАЦИИ |
| RO | INSTRUCȚIUNI DE INSTALARE
INSTRUCȚIUNI DE UTILIZARE | IT | ISTRUZIONI DI MONTAGGIO
MANUALE DI ISTRUZIONI |
| FR | NOTICE DE MONTAGE
MANUEL INSTRUCTIONS | SK | MONTÁŽNY NÁVOD
NÁVOD NA POUŽITIE |
| HU | KÖZGYŰLÉS UTASÍTÁSOK
KEZELÉSI UTASÍTÁS | CZ | MONTÁŽNÍ NÁVOD
NÁVOD K POUŽITÍ |
| SI | NAVODILA ZA MONTAŽO
NAVODILA ZA UPORABO | PT | INSTRUÇÕES DE MONTAGEM
MANUAL DO USUÁRIO |
| ES | INSTRUCCIONES DE MONTAJE
MANUAL DEL USUARIO | HR | UPUTE ZA MONTAŽU
UPUTE ZA UPOTREBU |

F/B

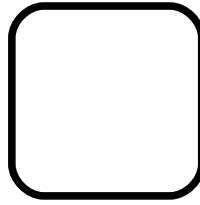
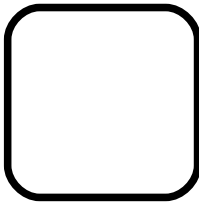

0019

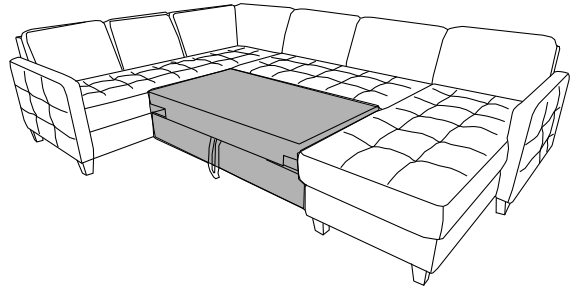
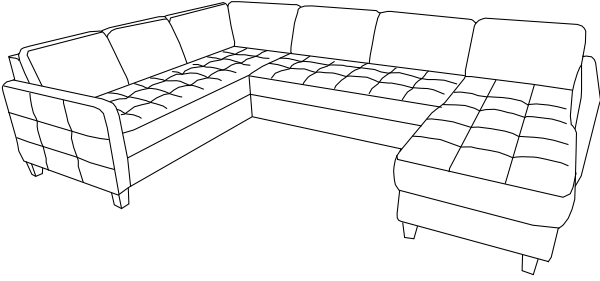

0019

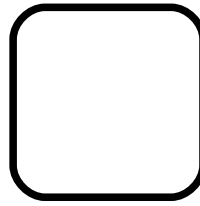
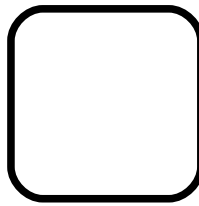

0089

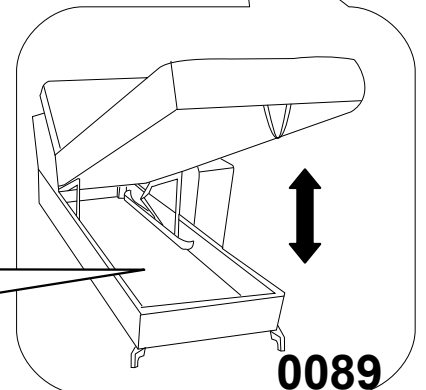
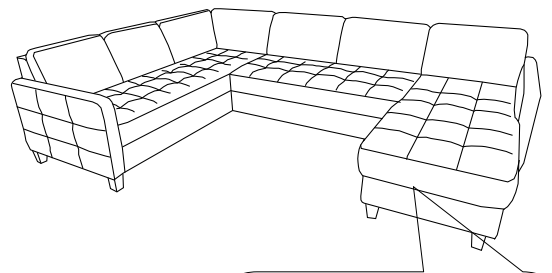
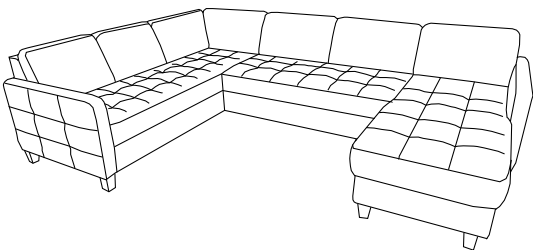
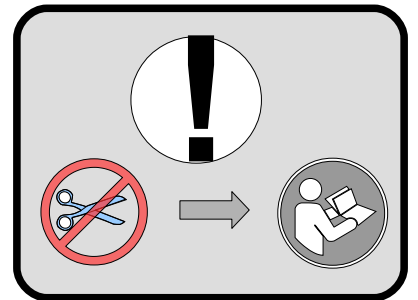







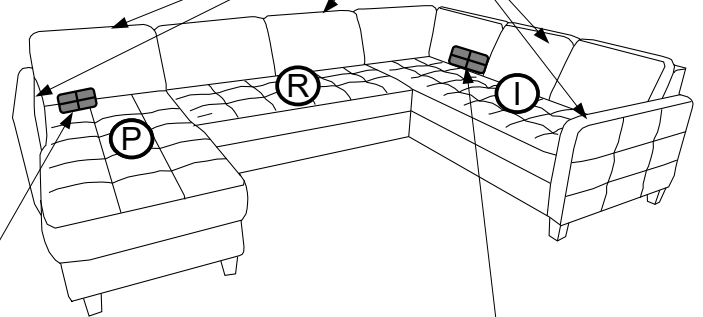
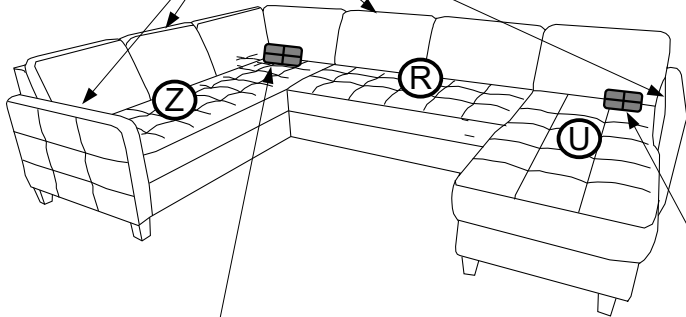
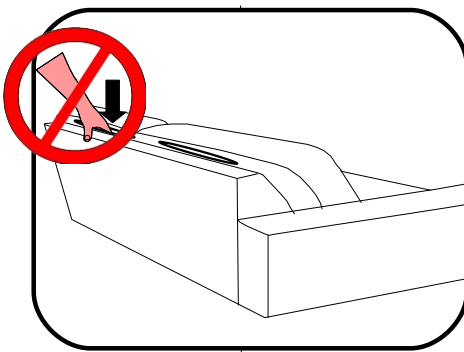



0089





L

R



g H- 100  X2	f H- 100  X5	X Fi- 35  X5	V M8*80  X5	i L- 5 [mm]  X1
--	--	--	---	---

g H- 100  X2	f H- 100  X4	X Fi- 35  X4	V M8*80  X4	i L- 5  X1
---	--	--	---	--



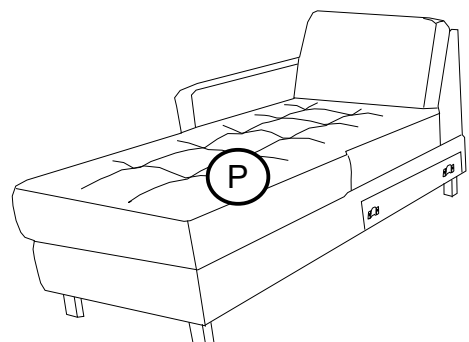
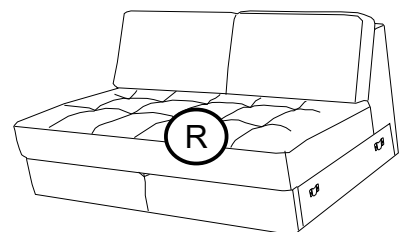
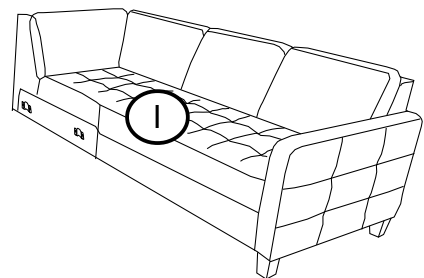
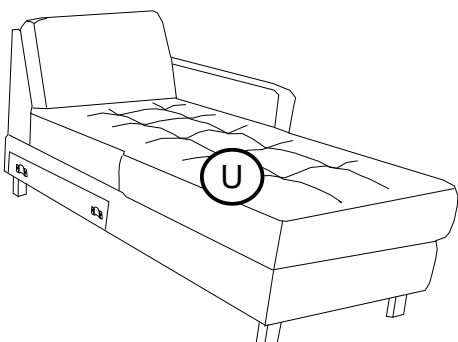
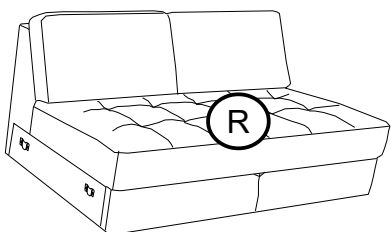
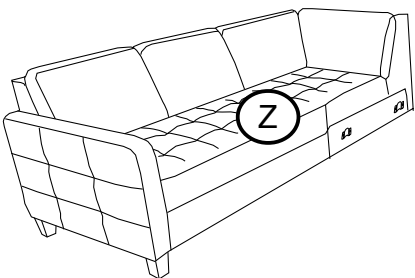

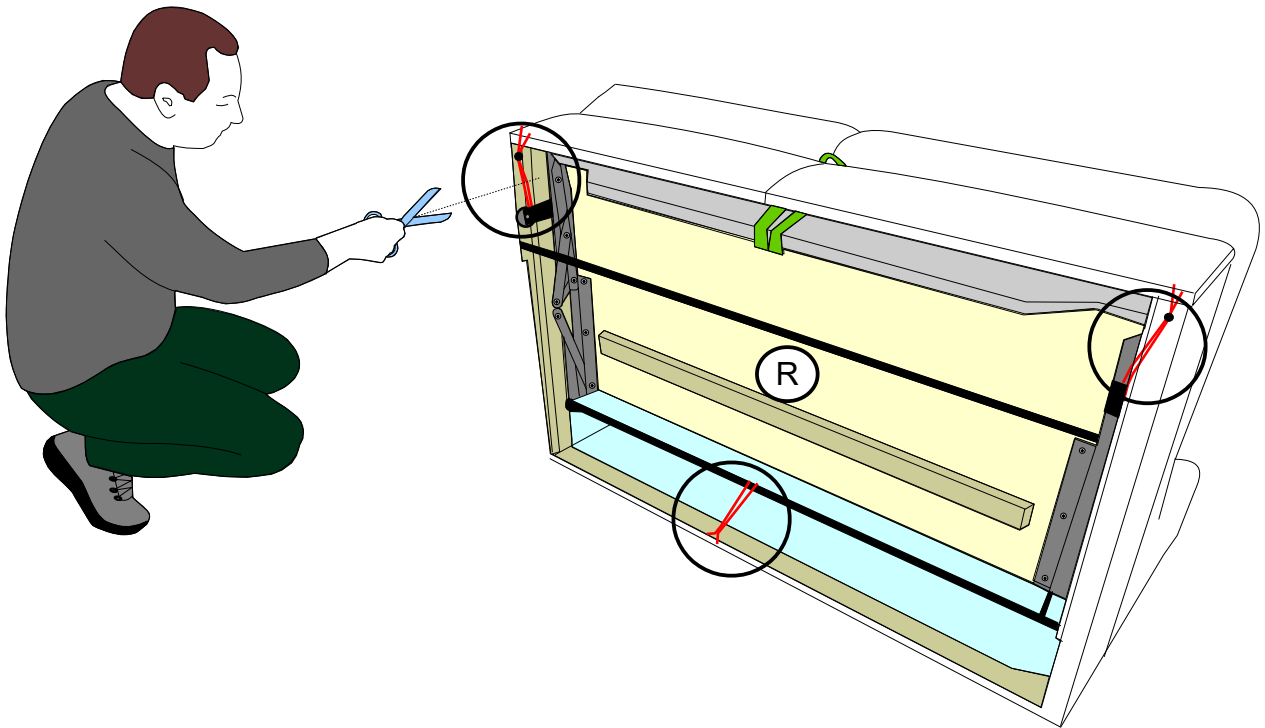
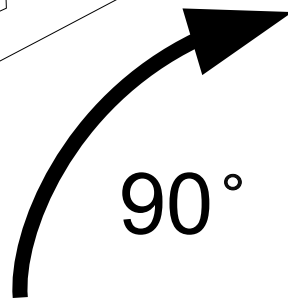
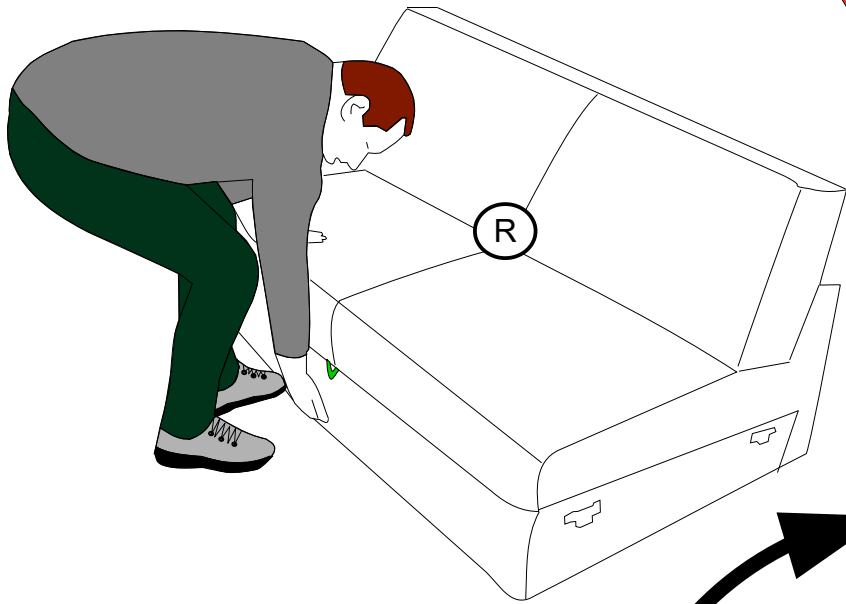
g H- 100  X2	f H- 100  X4	X Fi- 35  X4	V M8*80  X4	i L- 5  X1
--	--	--	---	--



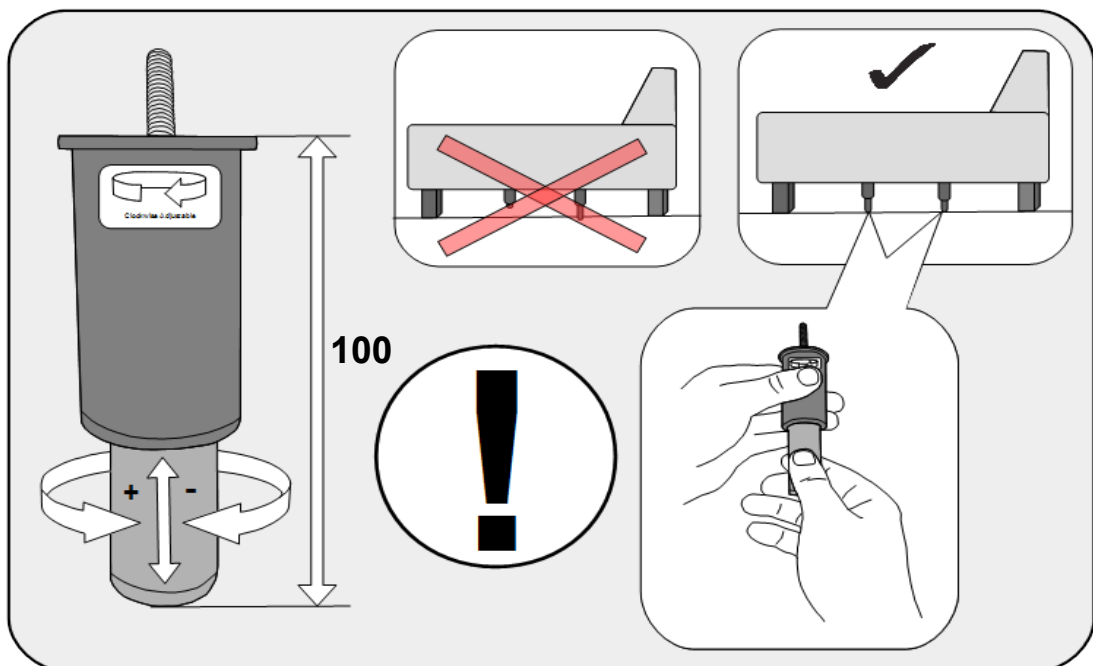
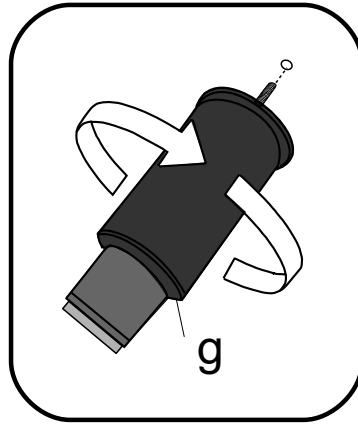
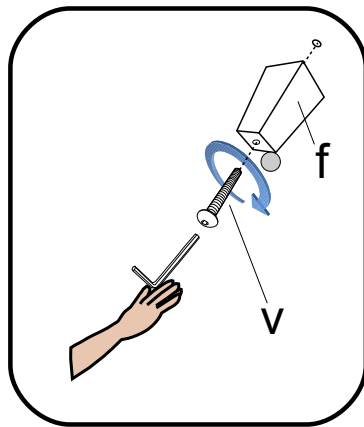
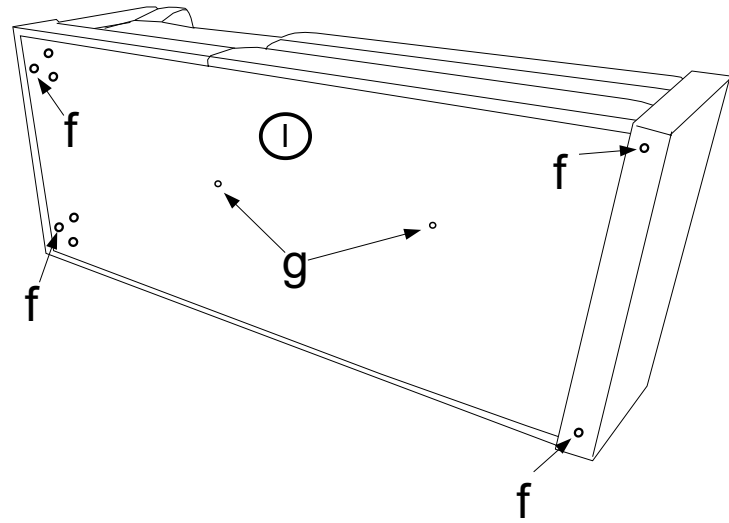
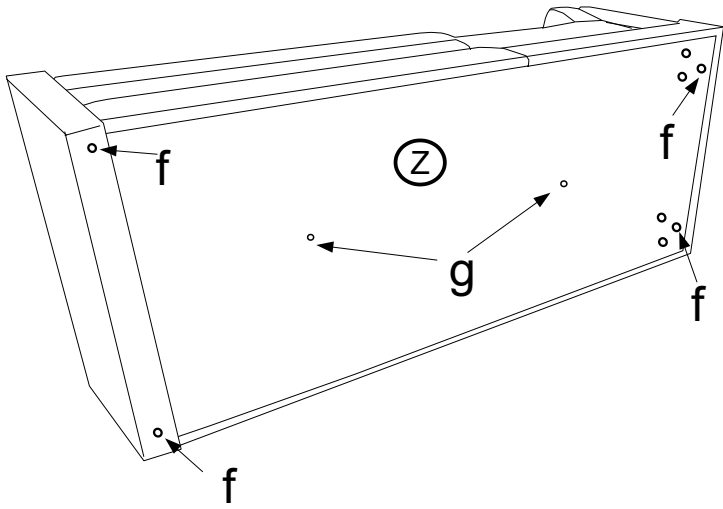
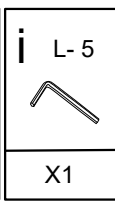
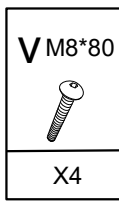
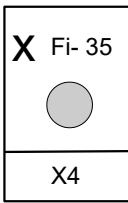
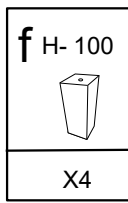
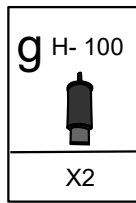

0019



g H- 100 	f H- 100 	X Fi- 35 	V M8*80 	i L- 5 
X2	X5	X5	X5	X1

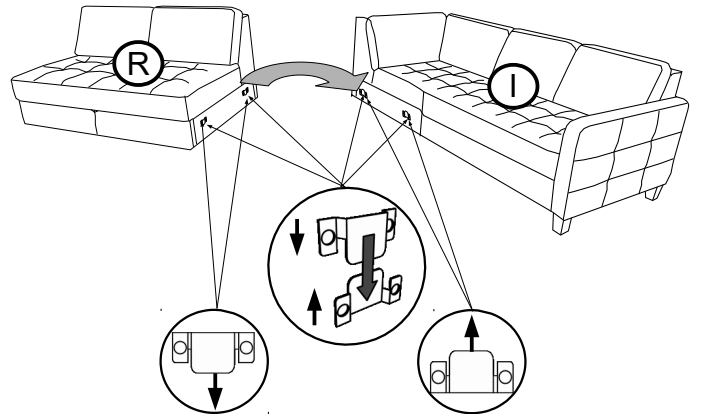
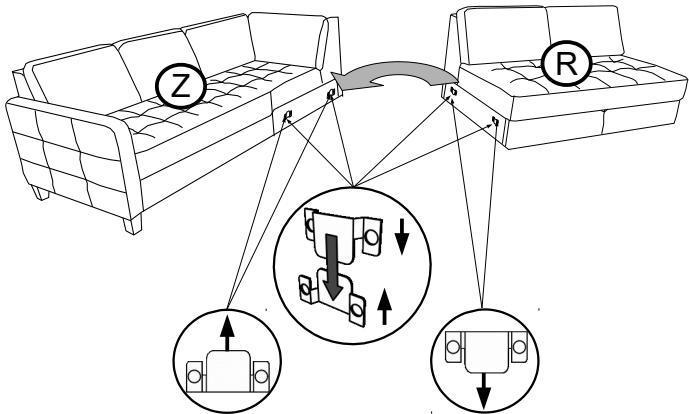
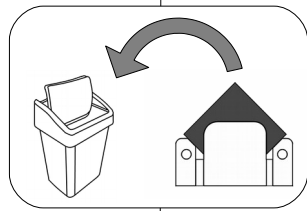
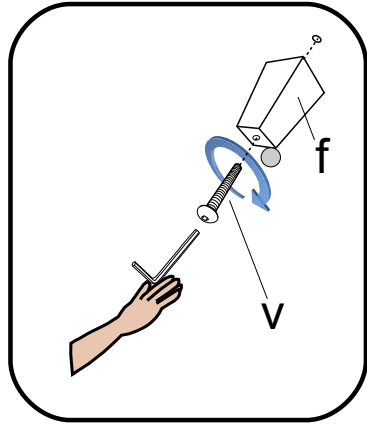
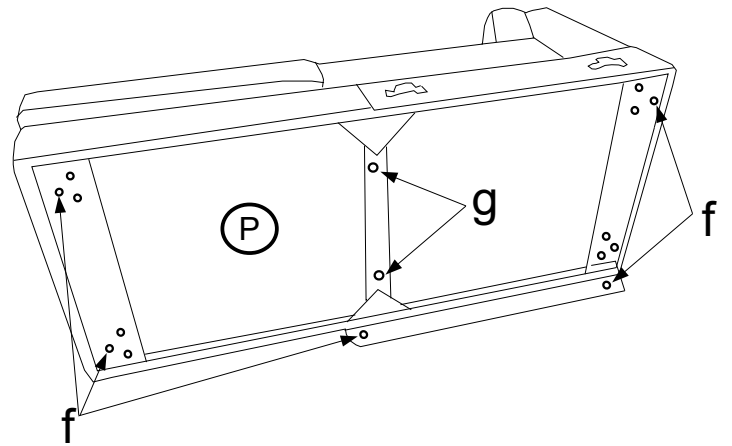
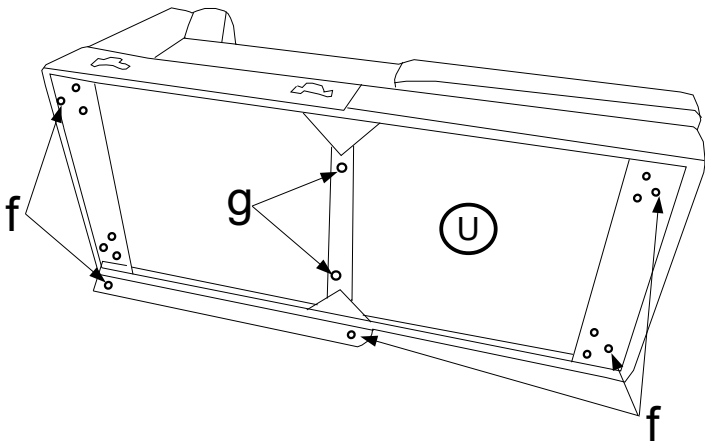

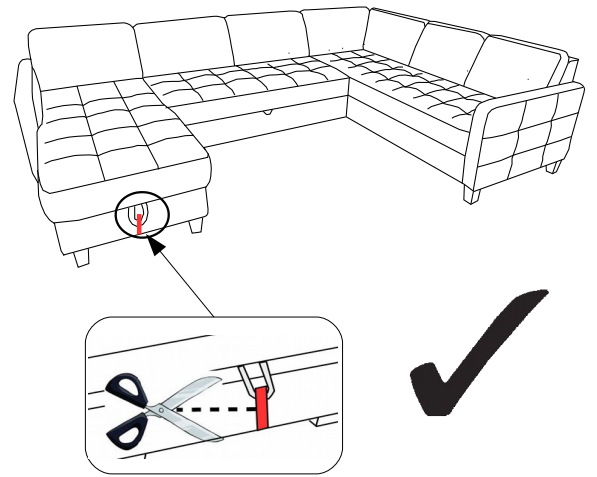
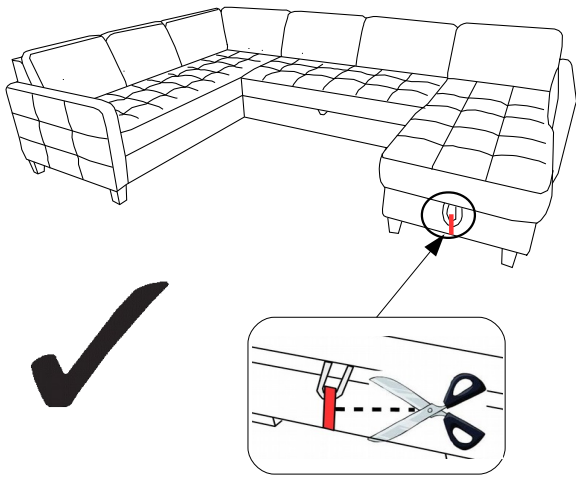
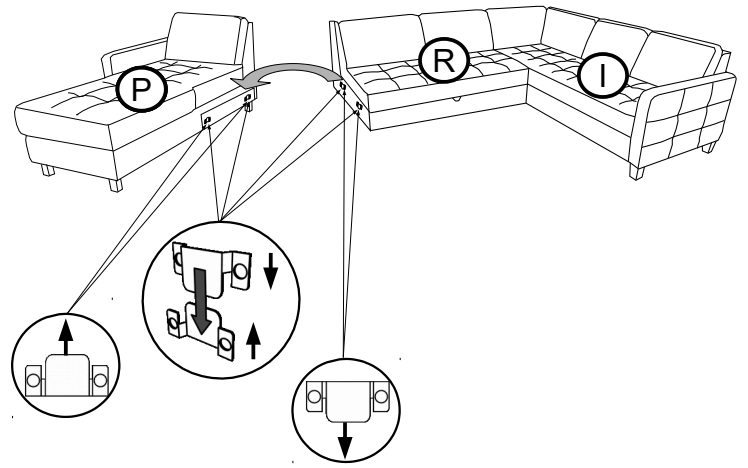
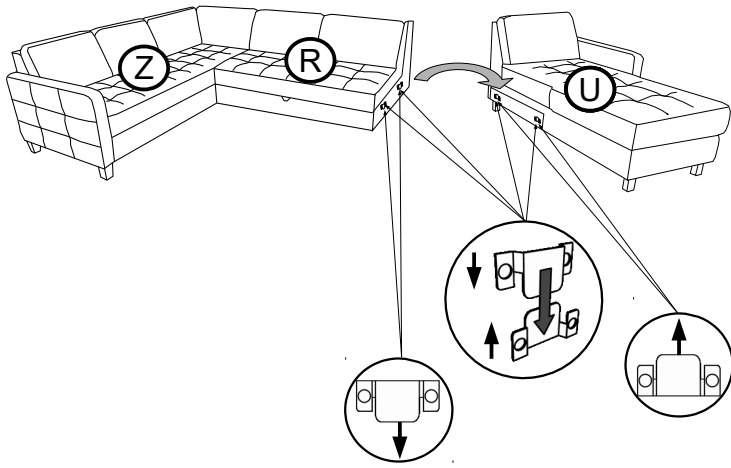

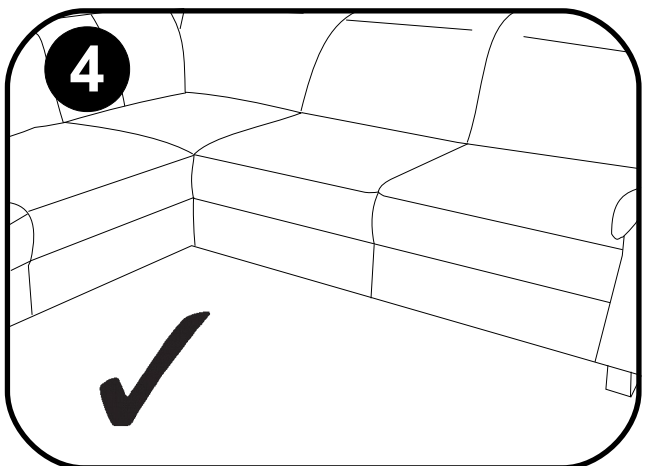
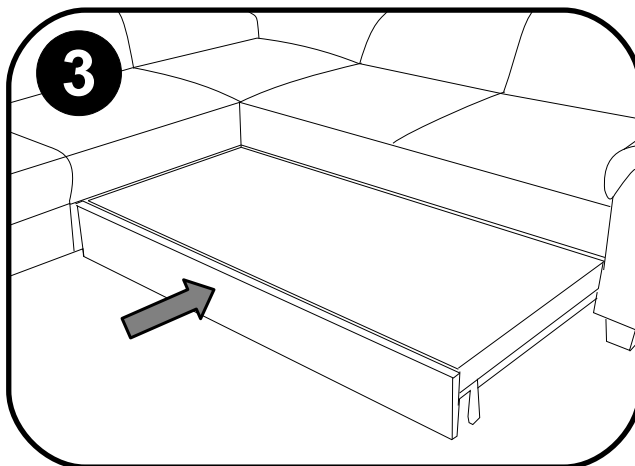
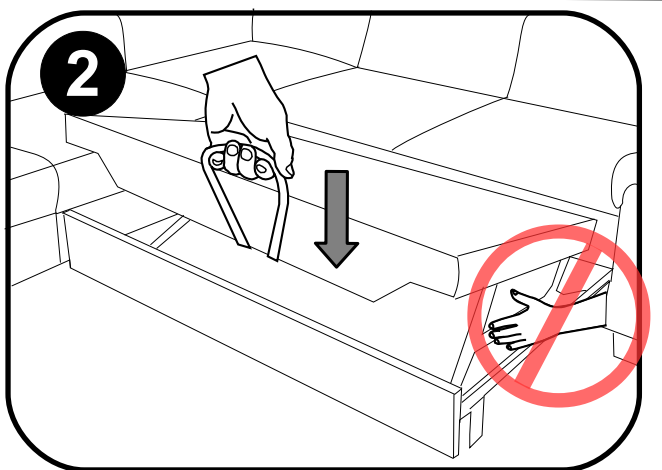
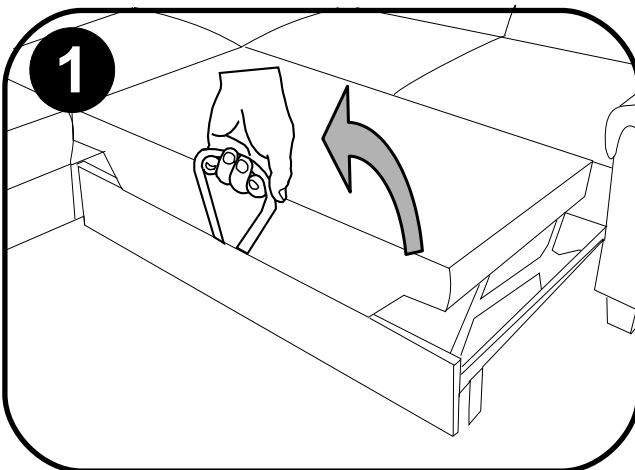
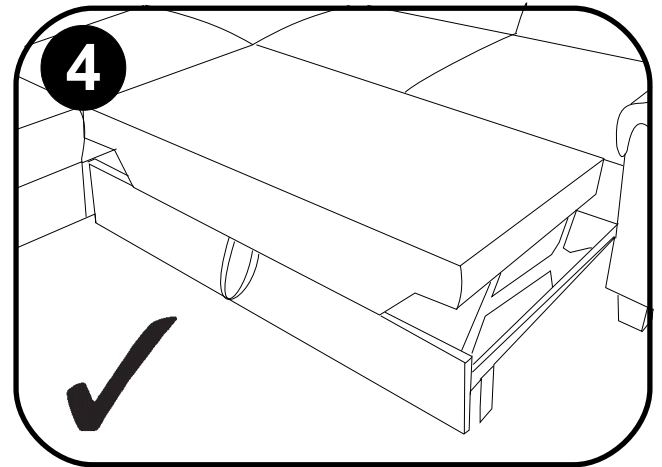
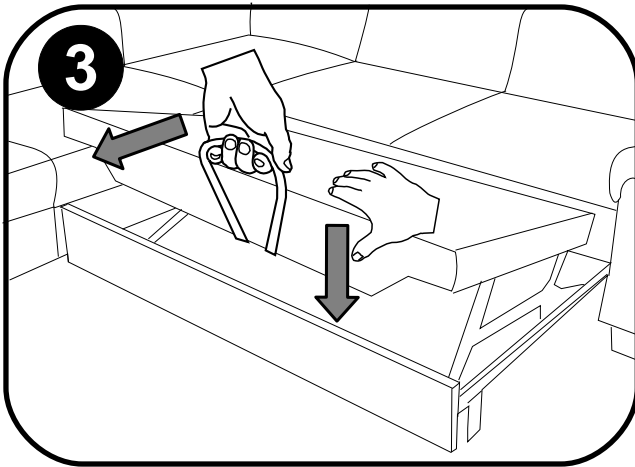
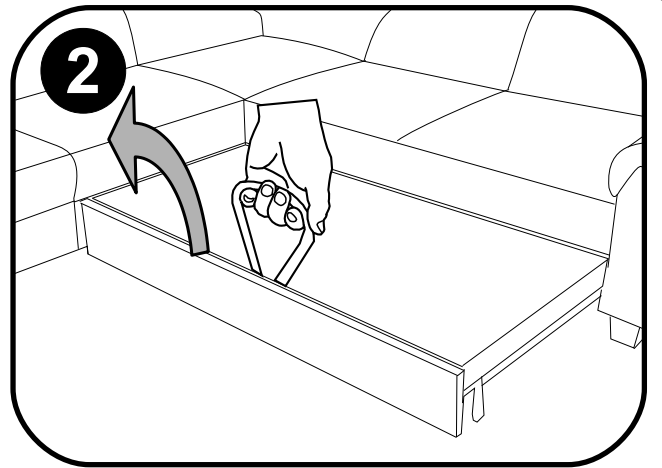
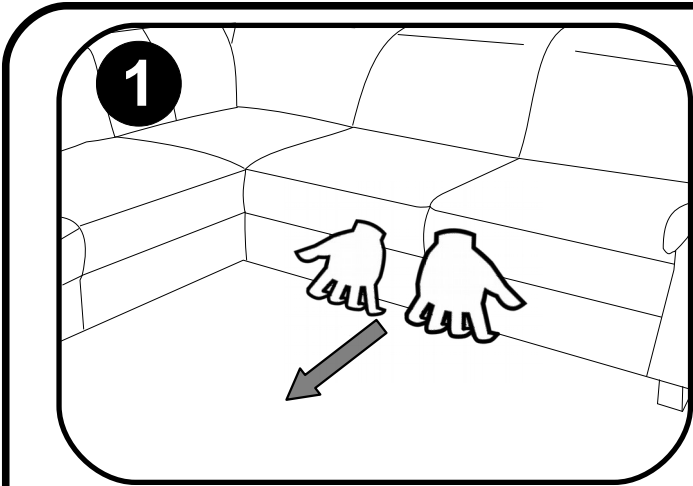
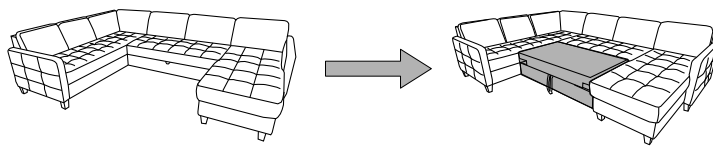



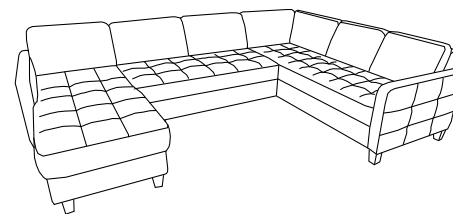
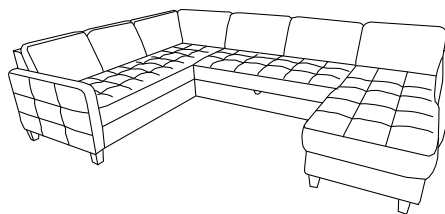
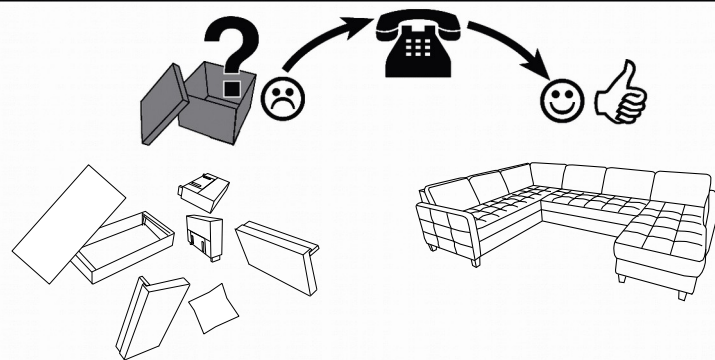
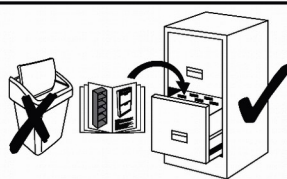

Name · Naam · Nazwa · Ísim · Название · Nume · Nome · Názov · Názov ·
 Název · Neve

EARL

Typ · Type · Tip · Тип · Tipo · Típus



g H- 100 	f H- 100 	X Fi- 35 	V M8*80 [mm] 
--	--	--	---

