

pelipal

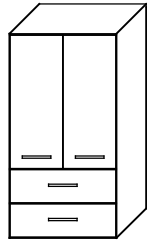

MOT-NZ0238S1 A4
Datum 02/09/19

3__-015056

9__-015056

T1

Bitte unbedingt ausfüllen!

Name -----
Strasse -----
PLZ ----- Ort -----
Tel. -----

T2

Sehr geehrte Kunden,
wir freuen uns, dass Sie sich für ein Produkt aus dem Hause Pelipal entschieden haben. Sollte es trotz aller Bemühungen unsererseits, Ihnen ein qualitativ hochwertiges Möbelstück zu liefern, zu Fehlteilen kommen, schicken Sie bitte dieses ausgefüllte Blatt an

Fax.: +49 3443/434350

E-Mail: ersatzteile@pelipal.de

Bitte beachten Sie, dass Bauteile über 800mm Länge und 350mm Breite direkt bei Ihrem Möbelhändler zu beanstanden sind. Zur Reklamationsbearbeitung ist es unbedingt erforderlich **die Artikelnummer des Schrankes**, welche auf dem Etikett ersichtlich ist und den Markt, wo das Möbel erworben wurde anzugeben. Außerdem tragen Sie unten bitte die benötigte Stückzahl ein. Viel Spaß mit Ihrem neuen Badmöbel!

Ihr Pelipal Team

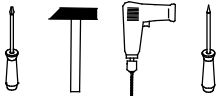

T3







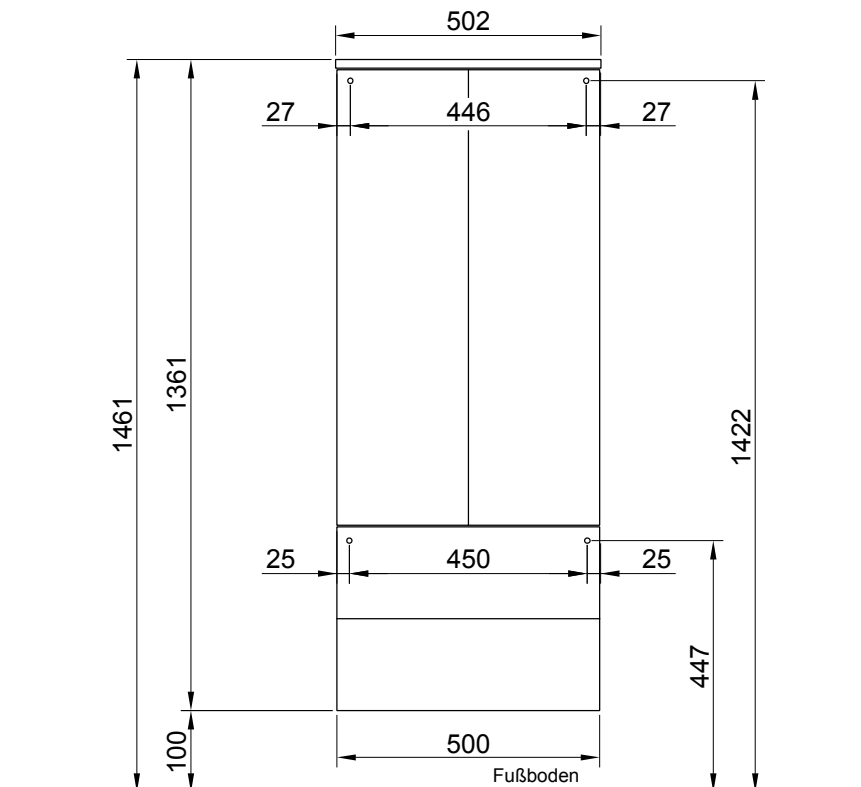



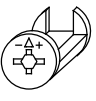
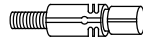

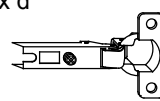
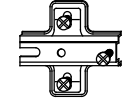

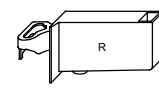
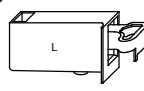

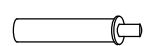

Für den Zusammenbau sind 2 Personen erforderlich.

T4

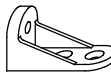
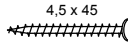
Montage-Richtzeit 3 Stunden

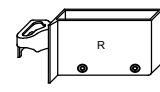
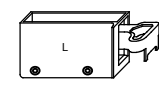
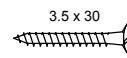
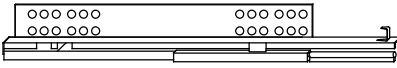
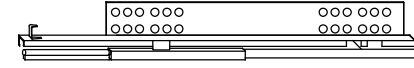

Die Maßangabe der Höhe ist nicht bindend!

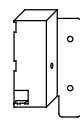
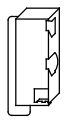
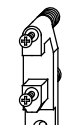
12 x a  EXZENTER-000015	Stück	12 x b  DUEB-SMD-000005	Stück	8 x c  TRAE-001-000020	Stück	6 x d  TBD-35-115X00	Stück	6 x e  ZPL-003X004	Stück
16 x f  SCH-KA-063X011	Stück	20 x g  SCH-SPA-035X015	Stück	1 x h  AUF-001-000080	Stück	1 x j  AUF-001-000090	Stück	4 x k  AUF-001-000020	Stück
6 x l  NAGEL-025X001	Stück	2 x m  TUER-DAEM-000010	Stück	2 x n  TUER-ADA-000010	Stück	4 x o  Griff	Stück	8 x p  SCH-RDK-045X045	Stück
4 x q  ADK-AL1-005X008	Stück	4 x r  RWD-KEI-000060	Stück	1 x s  VBD-000020	Stück	1 x t  SCH-RDK-045X045	Stück	1 x u  SCH-RDK-040X015	Stück
1 x v  AUF-001-000085	Stück	1 x w  AUF-001-000095	Stück	4 x x  SCH-SPA-035X030	Stück		Stück		Stück
2 x IT01  KA-260-LI			Stück	2 x IT02  KA-260-RE			Stück		Stück
2 x IT03  ZAR-260-LI			Stück	2 x IT04  ZAR-260-RE			Stück	4 x IT05  ADK-ZAR-ALU	Stück
24 x IT06  SCH-RDK-040X015	Stück	2 x IT07  VBD-ZAR-LI-70	Stück	2 x IT08  VBD-ZAR-RE-70	Stück	4 x IT09  VBD-ZAR-FRO	Stück		Stück

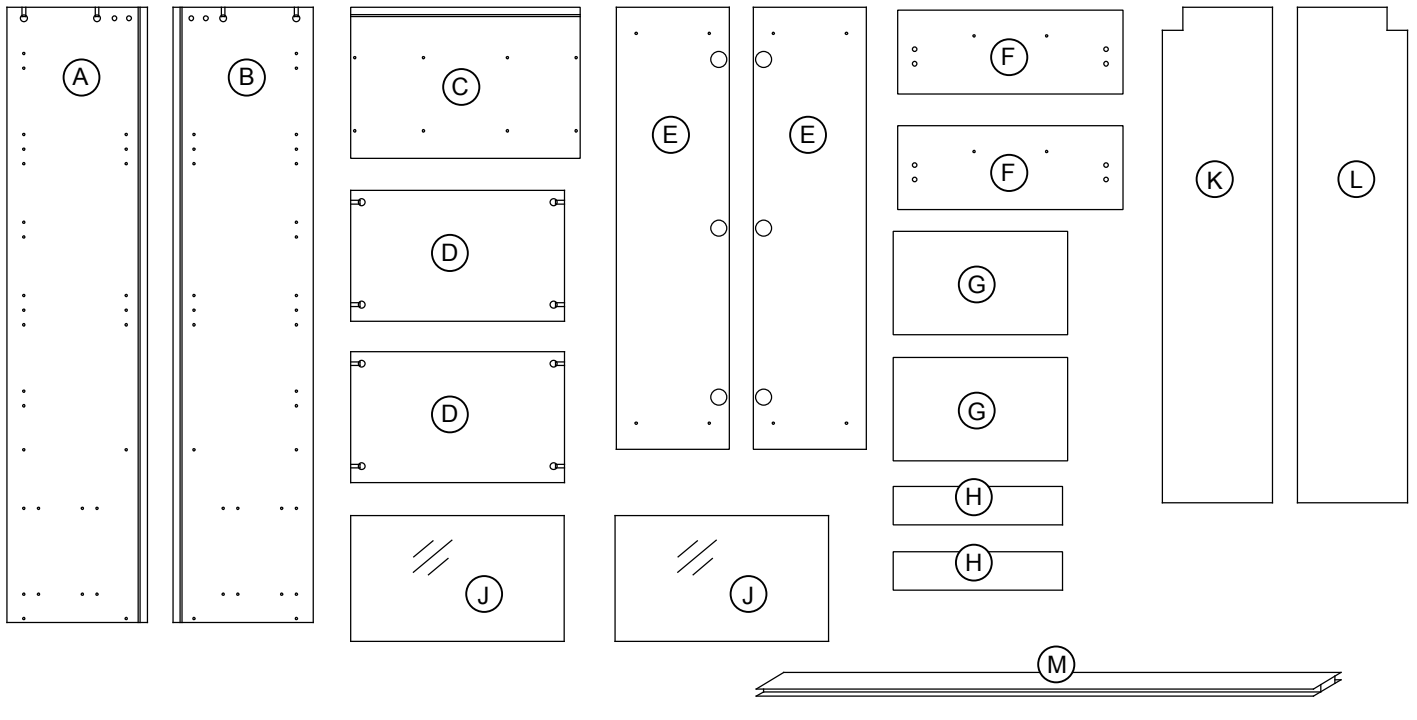

1.

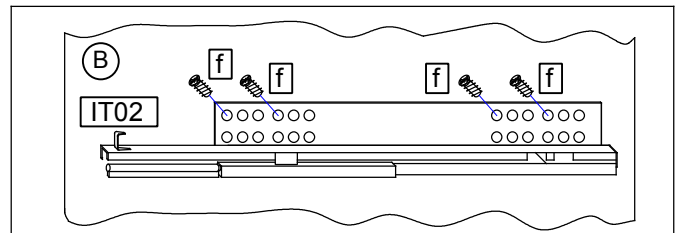
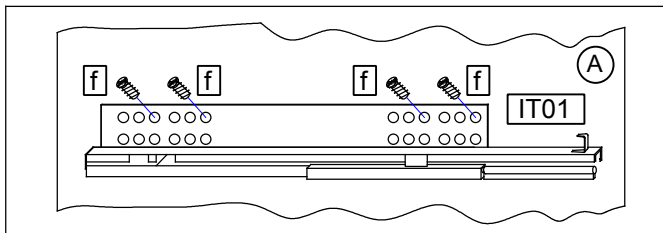
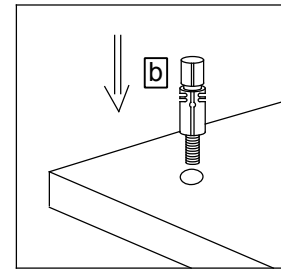
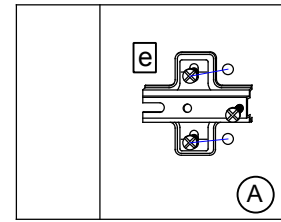
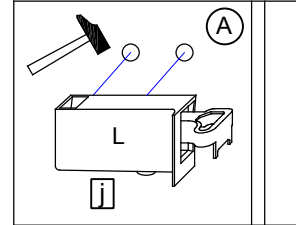
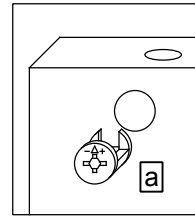
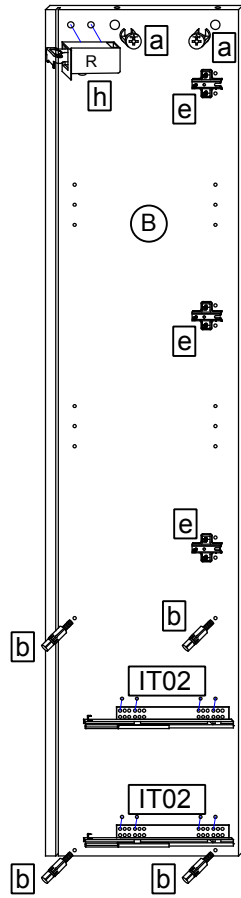
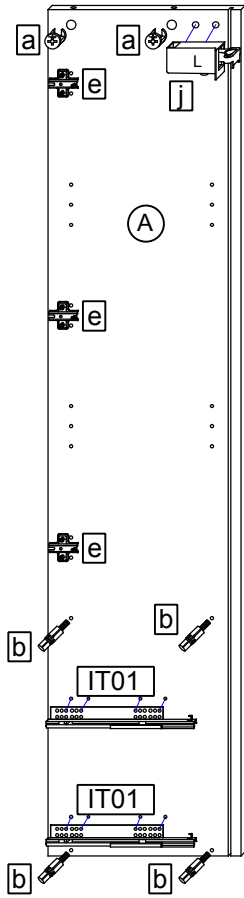
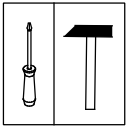

2.

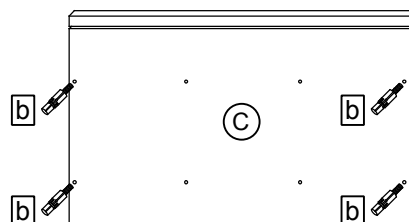
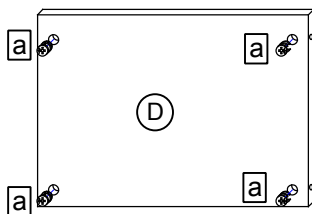
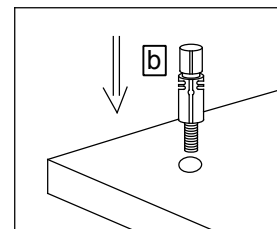
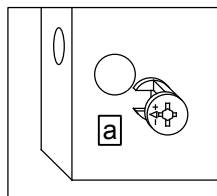
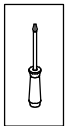

3.

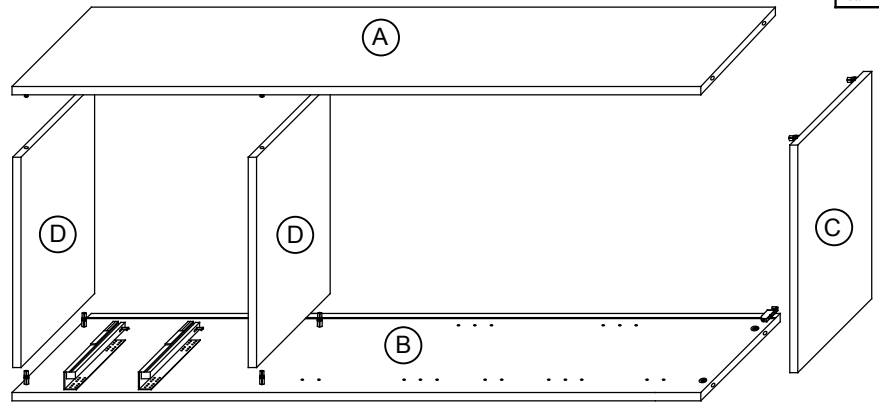
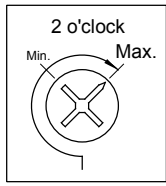
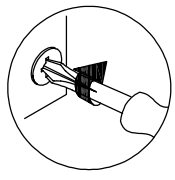
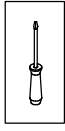

4.

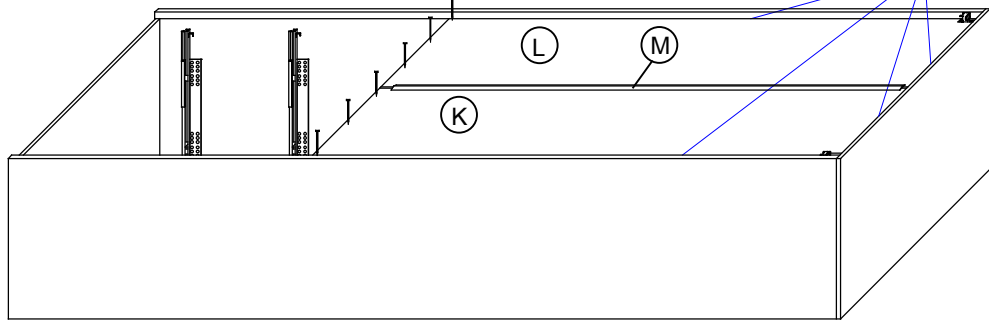
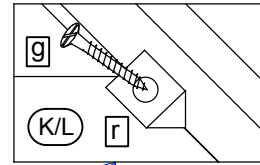
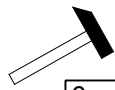
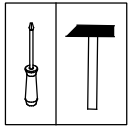

5.

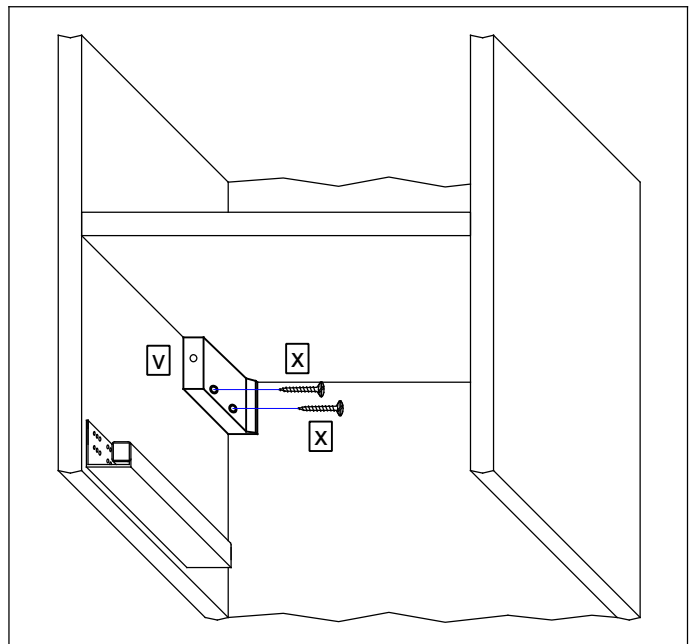
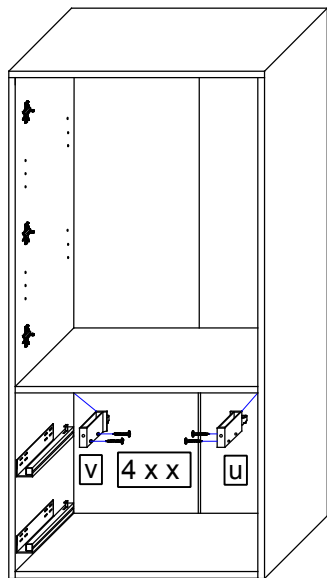
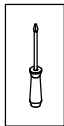

6.

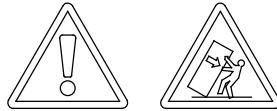
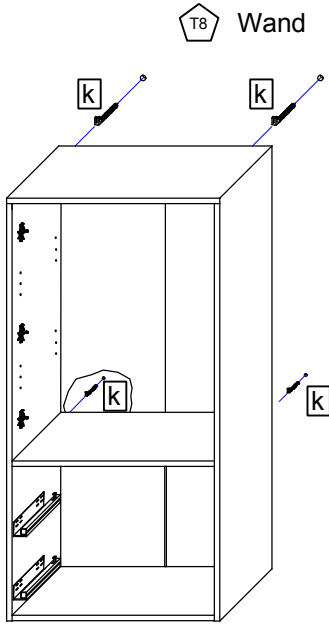
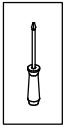

T9 Lassen Sie den Schrank nur durch fachkundige Personen mit für die Wand geeignetem Montagematerialien montieren.

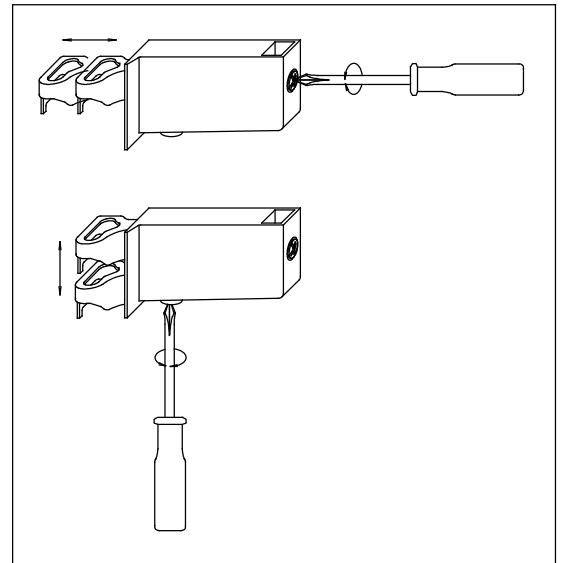
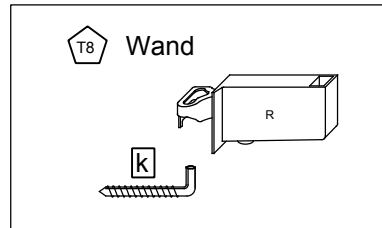

7.

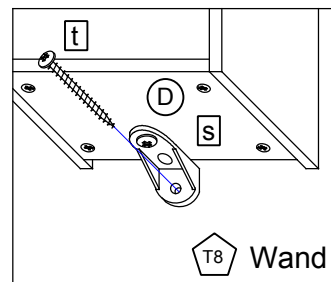
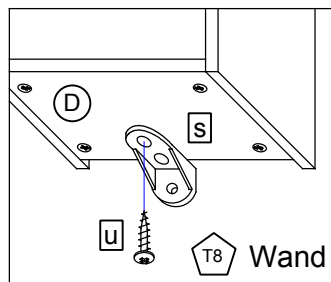
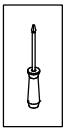

8.

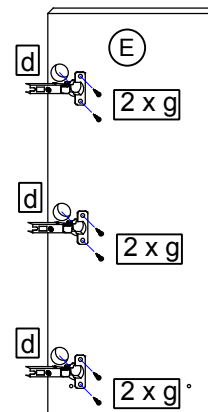
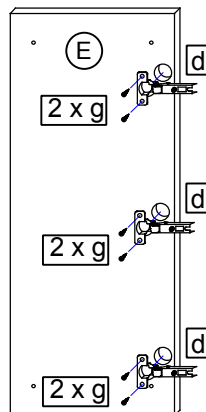
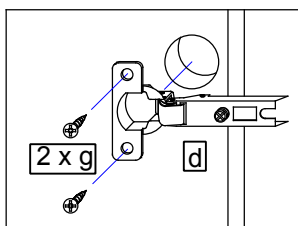
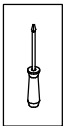

9.

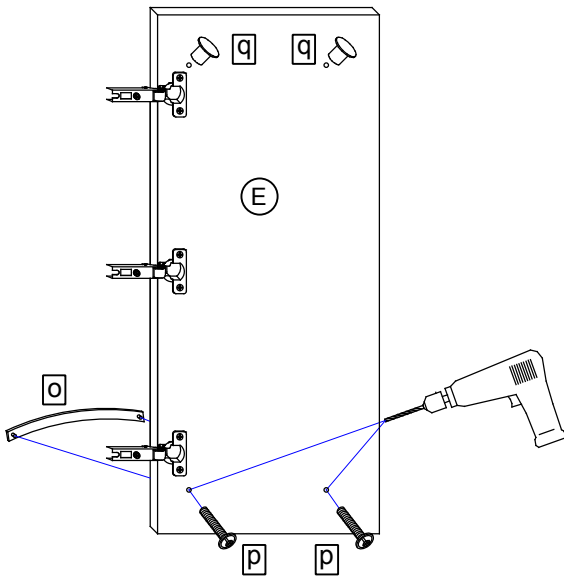
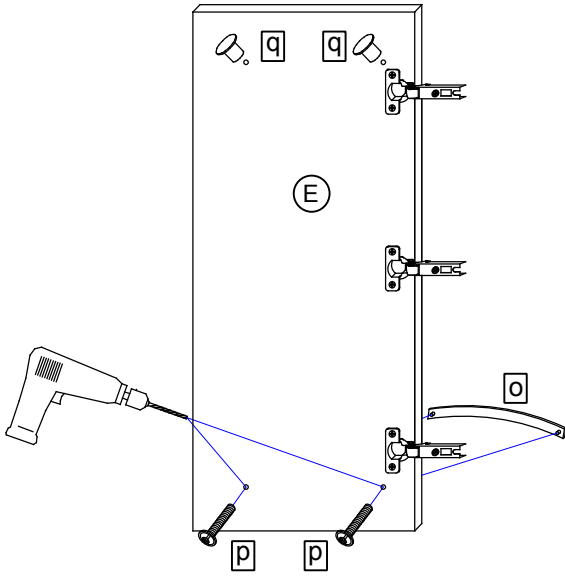
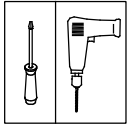

9.1

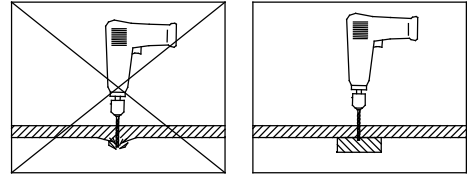

9.2

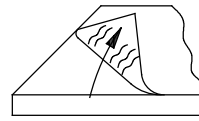

Bei Hochglanz-Fronten bitte erst die Schutzfolie entfernen und dann den Griff montieren!

9.3

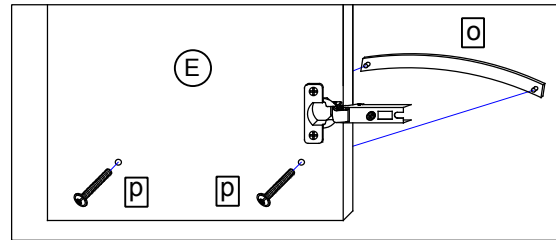

10.

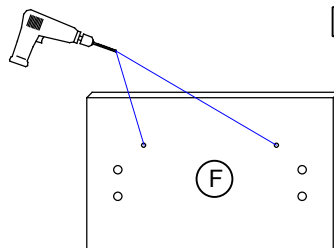
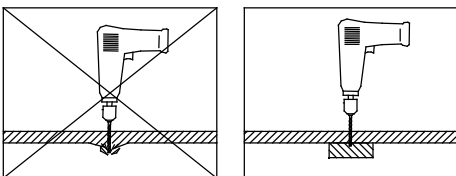
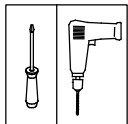

IT09

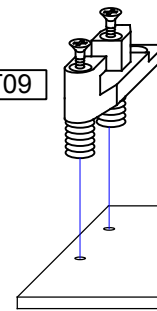

IT09

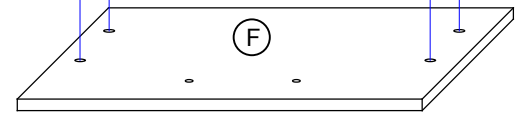

11.

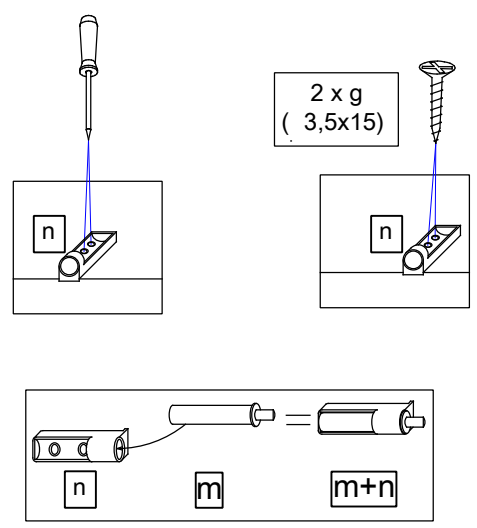
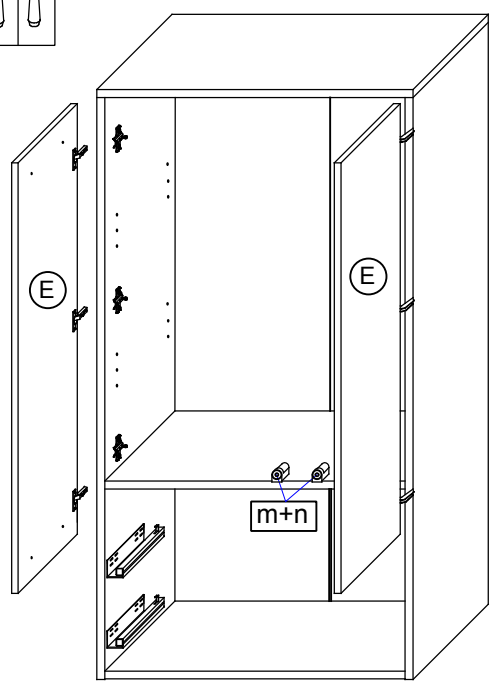
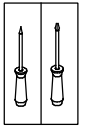

Bei Türmontage das Scharnier einhängen, bis Anschlag öffnen und anschließend festschrauben.

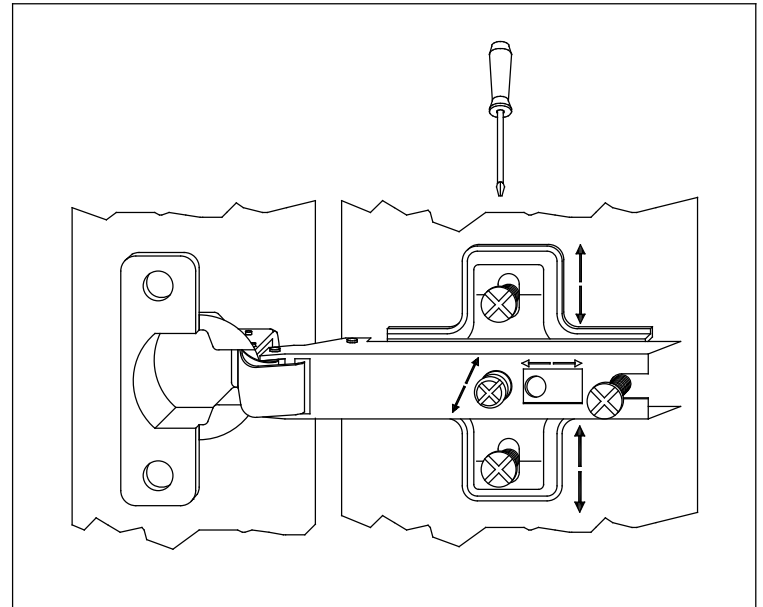
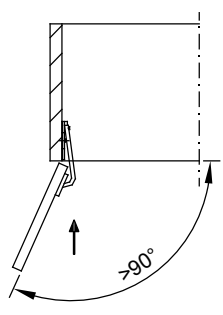

12.

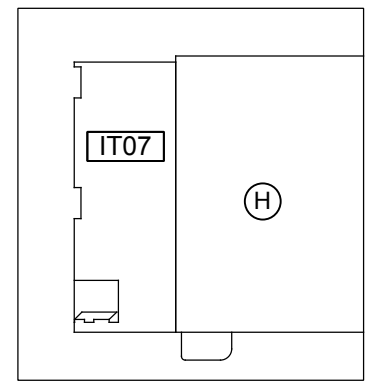
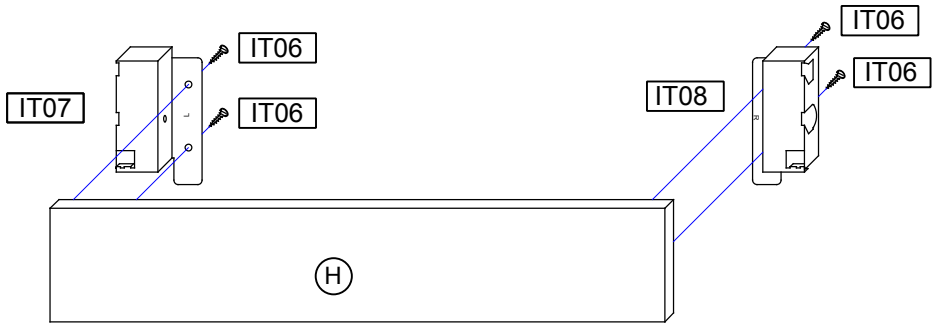
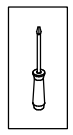

13.

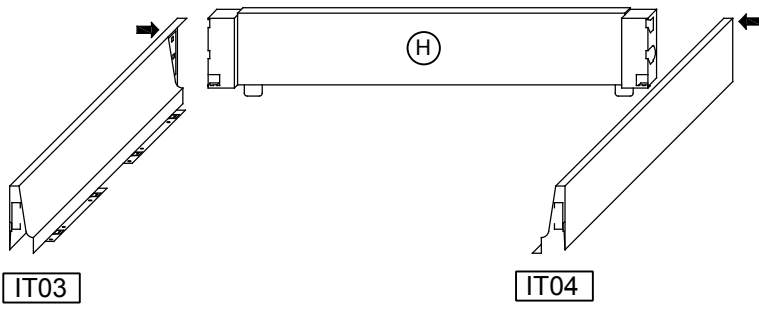

14.

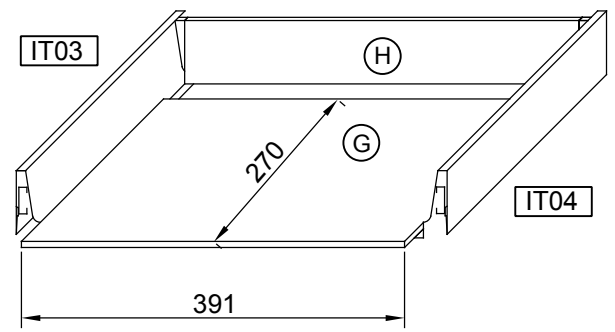

15.

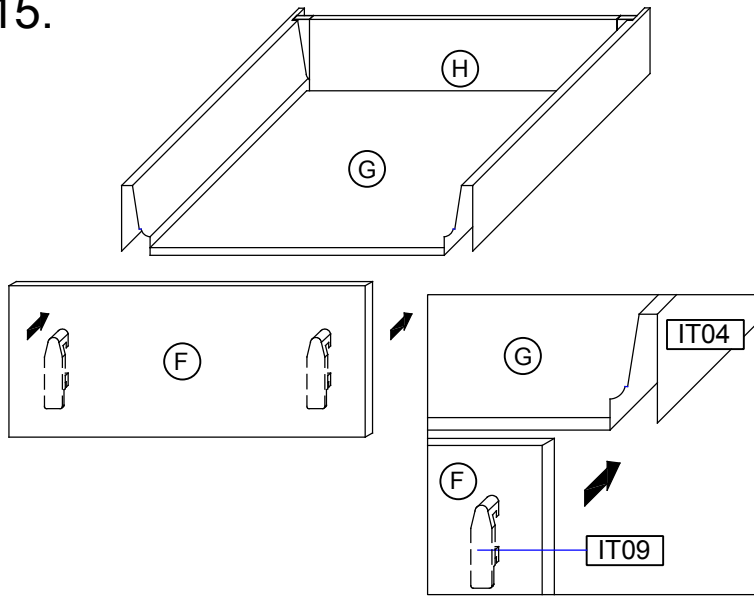

16.

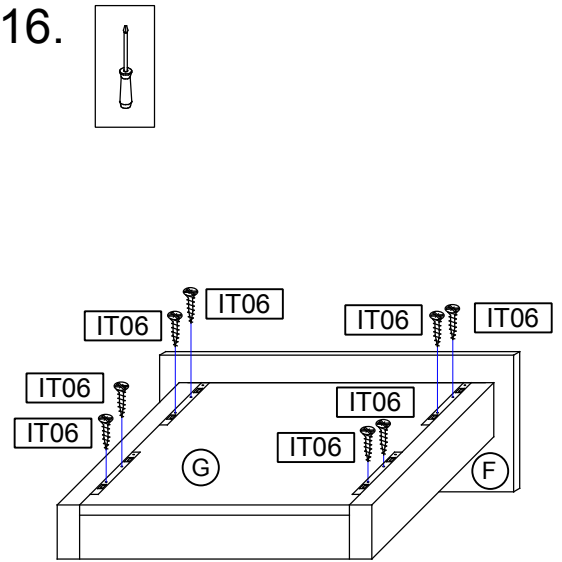

17

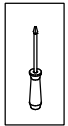

T10

Bei Hochglanz-Fronten bitte erst die Schutzfolie entfernen und dann den Griff montieren!

17.1

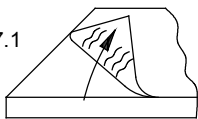

17.2

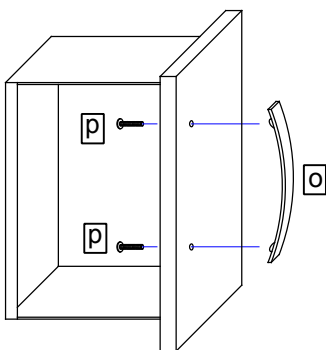

18.

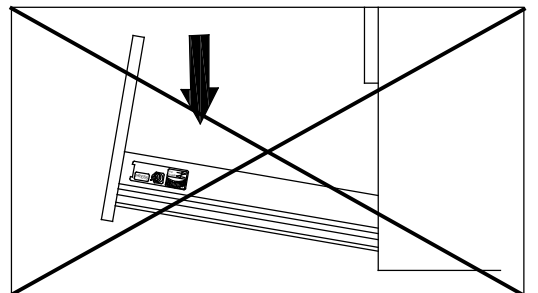
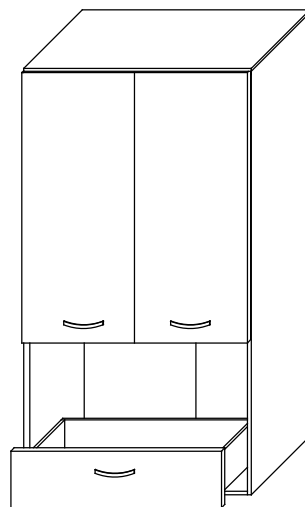

18.1

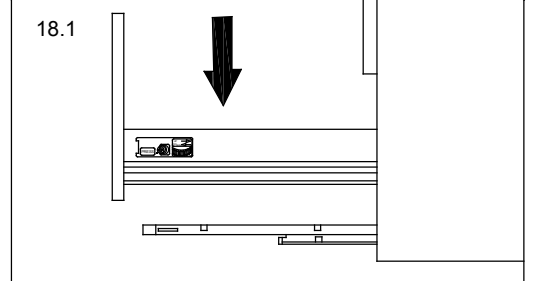

18.2

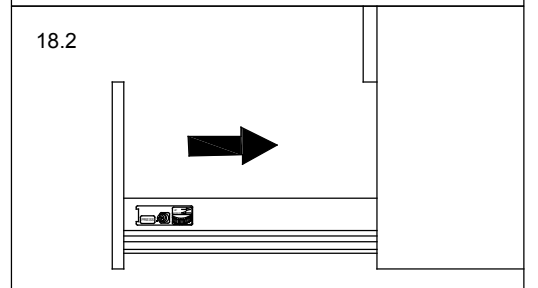

19.

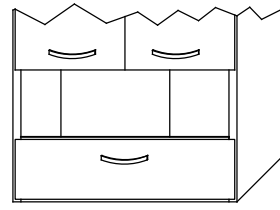
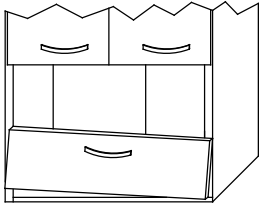
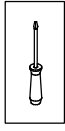

19.1

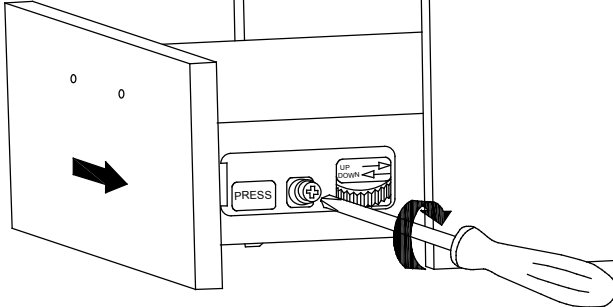

19.2

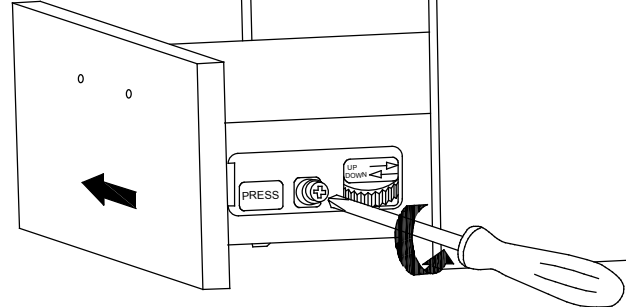

19.3

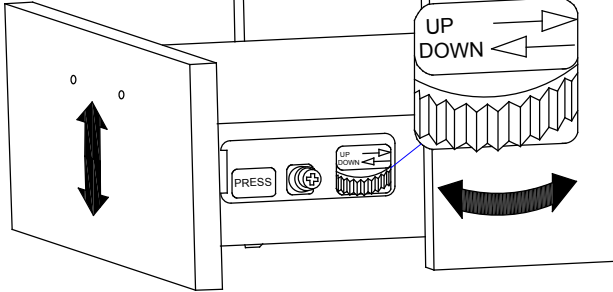

19.4

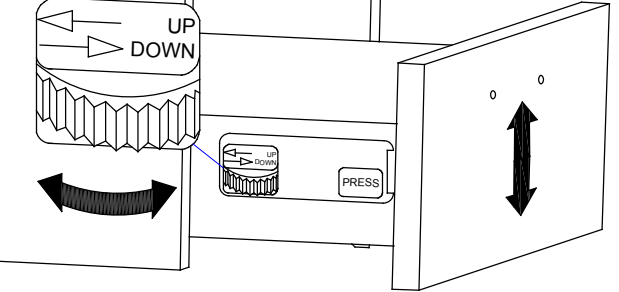

19.5

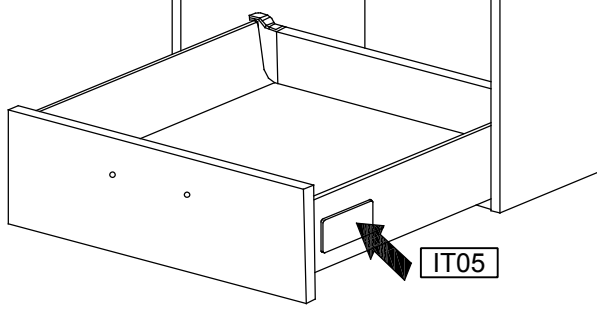

19.6

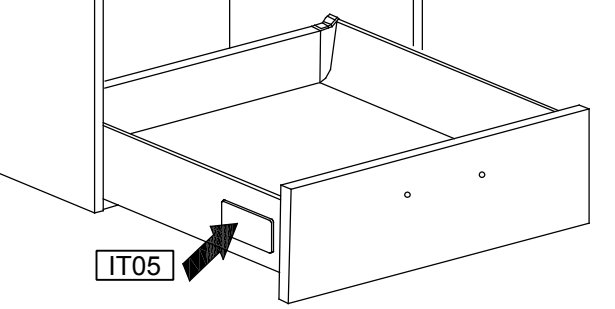

20.

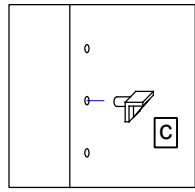
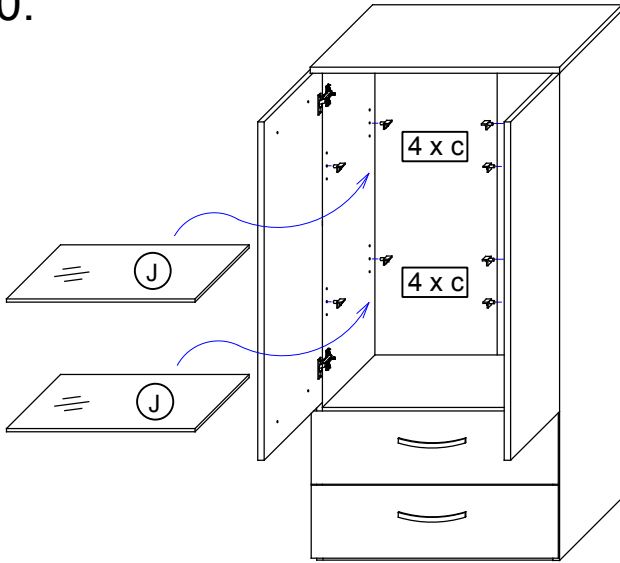

Das Möbel bitte nur mit einem feuchten Tuch reinigen.