

Modellname:
Nazwa modelu:

Nature Plus

Modellreihe:
Numer modelu: **1205FF22**

Type: **22**
Typ: **22**

Blatt Nr 1 von: 8
Strona z: 8

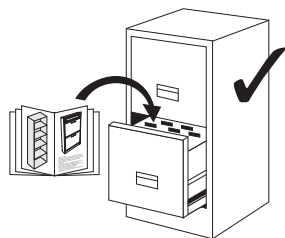

- D** Montageanleitung
- NL** Handleiding voor de montage
- TR** Montaj talimati
- GB** Assembly instructions
- PL** Instrukcja montażu
- RU** Инструкция по монтажу

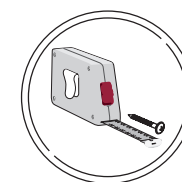
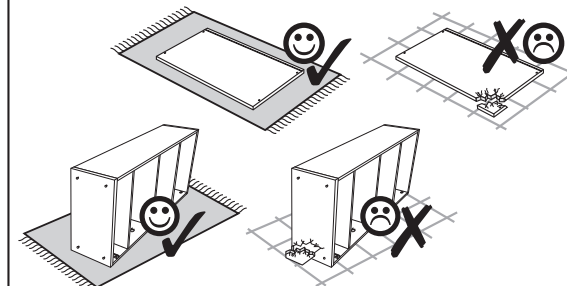
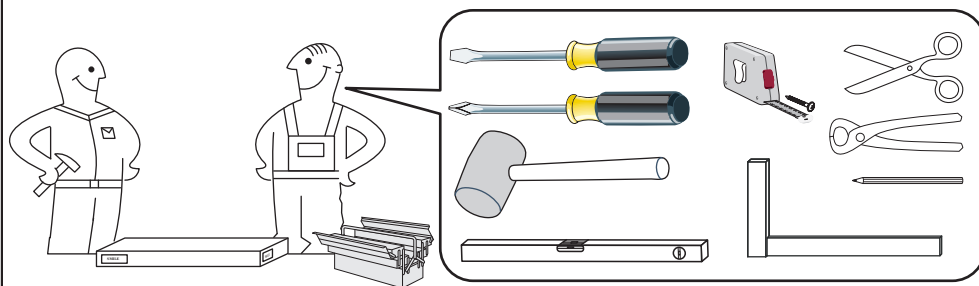
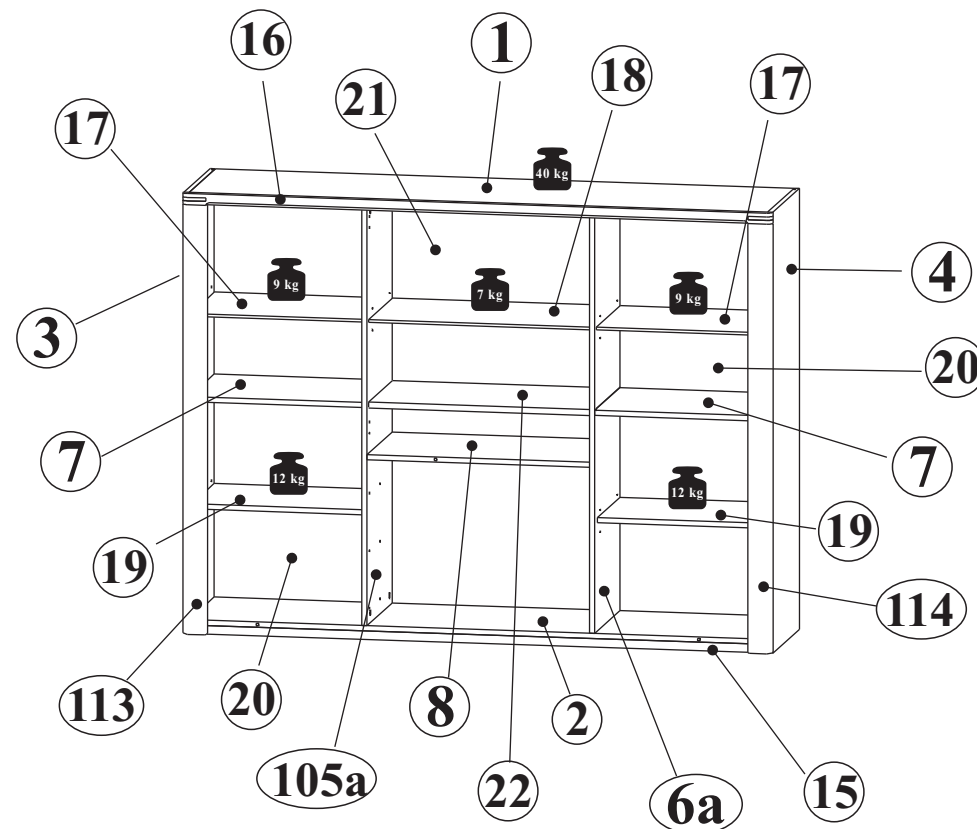
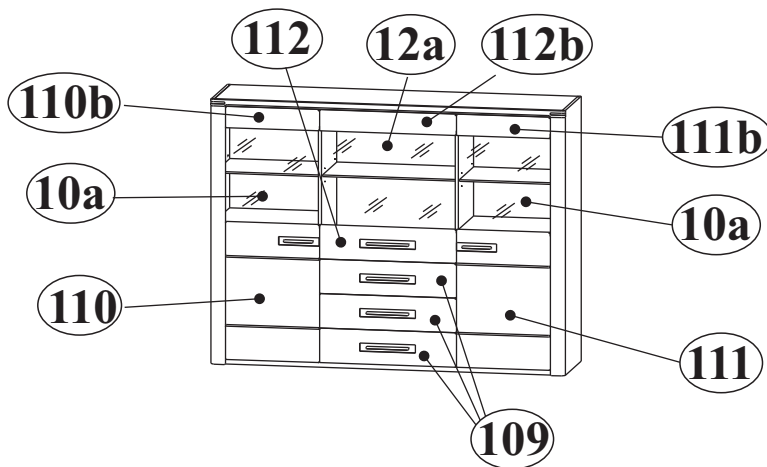

Modellname: **Nature Plus**
Nazwa modelu:

Modellreihe: **1205FF22**
Numer modelu:

Type: **22**
Typ:

Blatt Nr **2** von: **8**
Strona z:

D	Bitte nur mit einem Staubtuch oder leicht feuchtem Lappen reinigen. Keine scheuernden Putzmittel verwenden.
GB	Please only clean with a duster or a damp cloth. Do not use any abrasive cleaners.
NL	Reinig alleen met een stofdoek of een lichtjes vochtige doek. Gebruik geen schurende poetsmiddelen.
PL	Czyszczenie należy wykonać wyłącznie za pomocą ściereczki lub lekko nawilżonego ręcznika. Nie stosować środków czyszczących do szorowania.
TR	Lütfen sadece bir toz bezilye veya hafif nemli yumuşak bir bezle siliniz. Aşındırıcı temizlik malzemeleri kullanmayınız.
RU	Очищайте от пыли тряпкой или слегка влажной ветошью. Не допускается применение чистящих средств, не предназначенных для ухода за мебелью.

D	Stoßen Sie nicht mit harten Gegenständen an die Glasflächen oder -kanten.
GB	Do not bump glass surfaces or edges with hard objects.
NL	Stoot niet met harde voorwerpen tegen de glazen oppervlakken of randen.
PL	Nie uderzać twardymi przedmiotami w szklane powierzchnie i krawędzie.
TR	Cam yüzeylere veya cam kenarlara sert cisimlerle temas etmemeye dikkat ediniz.
RU	Не допускайте ударов твердыми предметами по стеклянным поверхностям или по их краям.

D	Ziehen Sie alle Schrauben sowie tragende Verbindungsteile nach ca. 5 Wochen nach, um eine dauerhafte Standsicherheit zu gewährleisten.
GB	After approx. 5 weeks, tighten all screws and load-bearing connecting parts to ensure permanent stability.
NL	Draai alle schroeven en ook dragende verbindingstukken na ca. 5 weken nog eens vast, zodat een continue stabiliteit wordt gegarandeerd.
PL	Aby zagwarantować trwałą stabilność mocowania należy po ok. 5 tygodniach dokręcić wszystkie śruby oraz elementy łączeniowe.
TR	Tüm vida ve taşıyıcı bağlantı parçalarını kalıcı bir duruş güvenliğini sağlamak için yaklaşık 5 hafta sonra tekrar sıkınız.
RU	Подкрутите все болты, а также несущие соединительные детали прикл. через 5 недель для обеспечения устойчивости в течение длительного времени.

D	Schützen Sie Ihre Möbel generell vor Wasser (z.B. beim Wischen oder Blumen gießen). Die Feuchtigkeit kann in das Möbelstück eindringen und es beschädigen.
GB	In general, keep water away from your furniture (e. g. when mopping or watering plants). The moisture may penetrate the furniture and damage it.
NL	Bescherm uw meubelen doorgaans tegen water (bijv. bij het dweilen of als u de bloemen water geeft). De vochtigheid kan in het meubelstuk dringen en het beschadigen.
PL	Mebel należy chronić przed wodą (np. podczas czyszczenia lub podlewania kwiatków). Wilgoć może wnikać w mebel i uszkodzić go.
TR	Genelde mobilyalannızı sudan koruyunuz (ömeğin, yerleri paspaslarken veya çiçekleri sularken). Nem, mobilya parçasına nüfuz edebilir ve zarar verebilir.
RU	Предохраняйте мебель от попадания воды (например, при вытирании или поливке цветов). Не допускайте попадания влаги на мебель, чтобы предотвратить ее повреждение.

D	Das beigefügte Wandbefestigungsmaterial (Dübel und Schrauben) eignet sich nur für festes Mauerwerk (z.B. Beton- oder Ziegelwände). Für andere Wandaufbauten sind eventuell Spezialdübel und andere Schrauben notwendig. Ziehen Sie gegebenenfalls eine Fachkraft zurate.
GB	The enclosed wall mounting materials (dowels and screws) are only suitable for solid masonry (e. g. concrete or brick walls). Special dowels and other screws may be necessary for other wall constructions. If necessary, please consult a qualified professional.
NL	Het bijgeleverde bevestigingsmateriaal (pluggen en schroeven) is geschikt voor vaste muren (bijv. betonnen of bakstenen muren). Voor andere muurconstructies zijn eventueel speciale pluggen en andere schroeven noodzakelijk. Consulteer eventueel een vakman.
PL	Załączony materiał mocowania w ścianach (kołki oraz śruby) nadaje się wyłącznie do zastosowania w stabilnym murze (np. ściany betonowe lub ceglane). Do montażu ściennych innego rodzaju konieczne są specjalne kołki i inne śruby. W przypadku wątpliwości prosimy zasięgnąć porady fachowca.
TR	Teslimat kapsamındaki duvar tipi sabitleme materyali (dübel ve vidalar) sadece beton ve tuğla duvarlar gibi sağlam duvar yapıları için uygundur. Başka duvar yapıları için özel dübeller veya başka vidalar gerekli olabilir. Gerekirse bir uzmandan yardım alınız.
RU	Входящий в комплект поставки материал для крепления на стене (дюбели и болты) предназначен только для прочных каменных стен (например, бетонных или кирпичных). Для других типов стен используйте по мере необходимости специальные дюбели и другие болты. По мере необходимости обратитесь за помощью к специалистам.

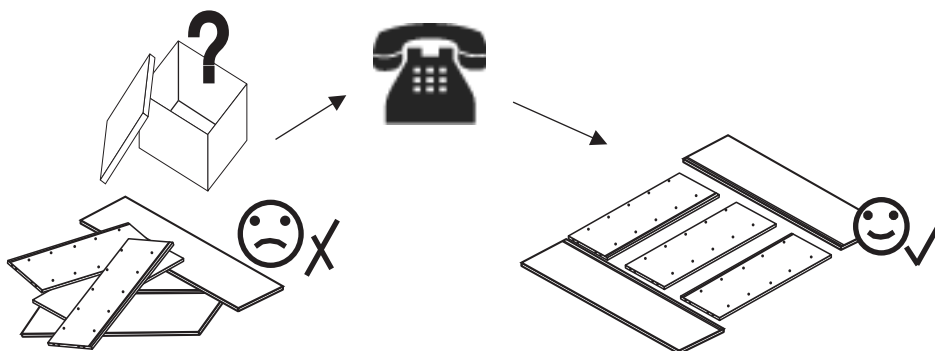

Modellname:
Nazwa modelu:

Nature Plus

Modellreihe:
Numer modelu:

1205FF22

Type:
Typ:

22

Blatt Nr
Strona

3

von:
z:

8

Nr1

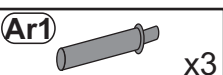
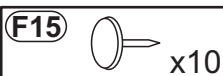
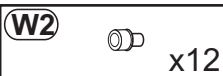
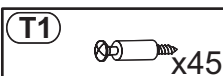
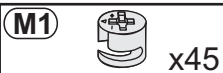

Nr2

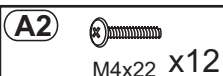
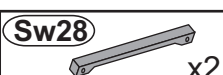
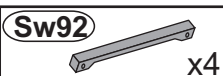

Nr3

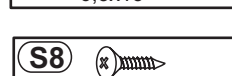
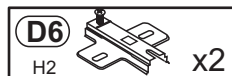
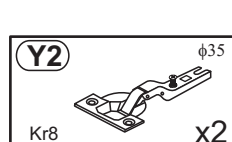

Nr4

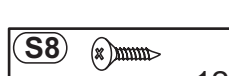
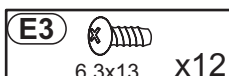
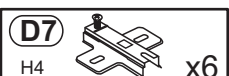
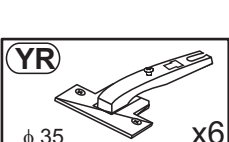

Nr5

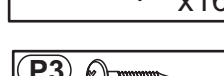
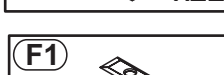

Nr6

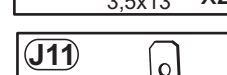
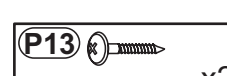

Nr7

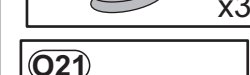

Nr8

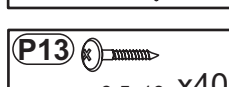
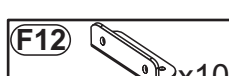

Nr9

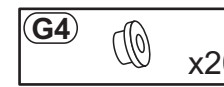
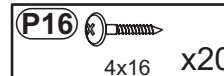

NR 10

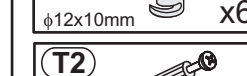
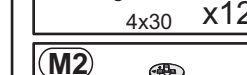
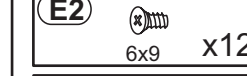

NR 11

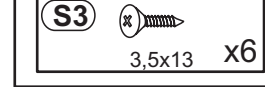
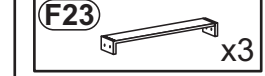

<http://www.innostyle-mvg.de>



BG	Bulgarisch	български
CS	Tschechisch	čeština
DA	Dänisch	Dansk
DE	Deutsch	Deutsch
ET	Estnisch	Eesti
EL	Griechisch	ελληνικά
EN	Englisch	English
ES	Spanisch	español
FR	Französisch	Français
FI	Finnisch	suomalainen
HR	Kroatisch	hrvatski
HU	Ungarisch	magyar
IT	Italienisch	Italiano
LV	Lettisch	Latvijas
LT	Litauisch	Lietuvos
NL	Niederländisch	Nederlands
PL	Polnisch	Polski
PT	Portugiesisch	português
RO	Rumänisch	român
SK	Slowakisch	slovenský
SL	Slowenisch	slovensčina
SV	Schwedisch	Svenska

innostyle
comfort edition

Möbelvertriebsgesellschaft mbH & Co. KG



874/2012



1

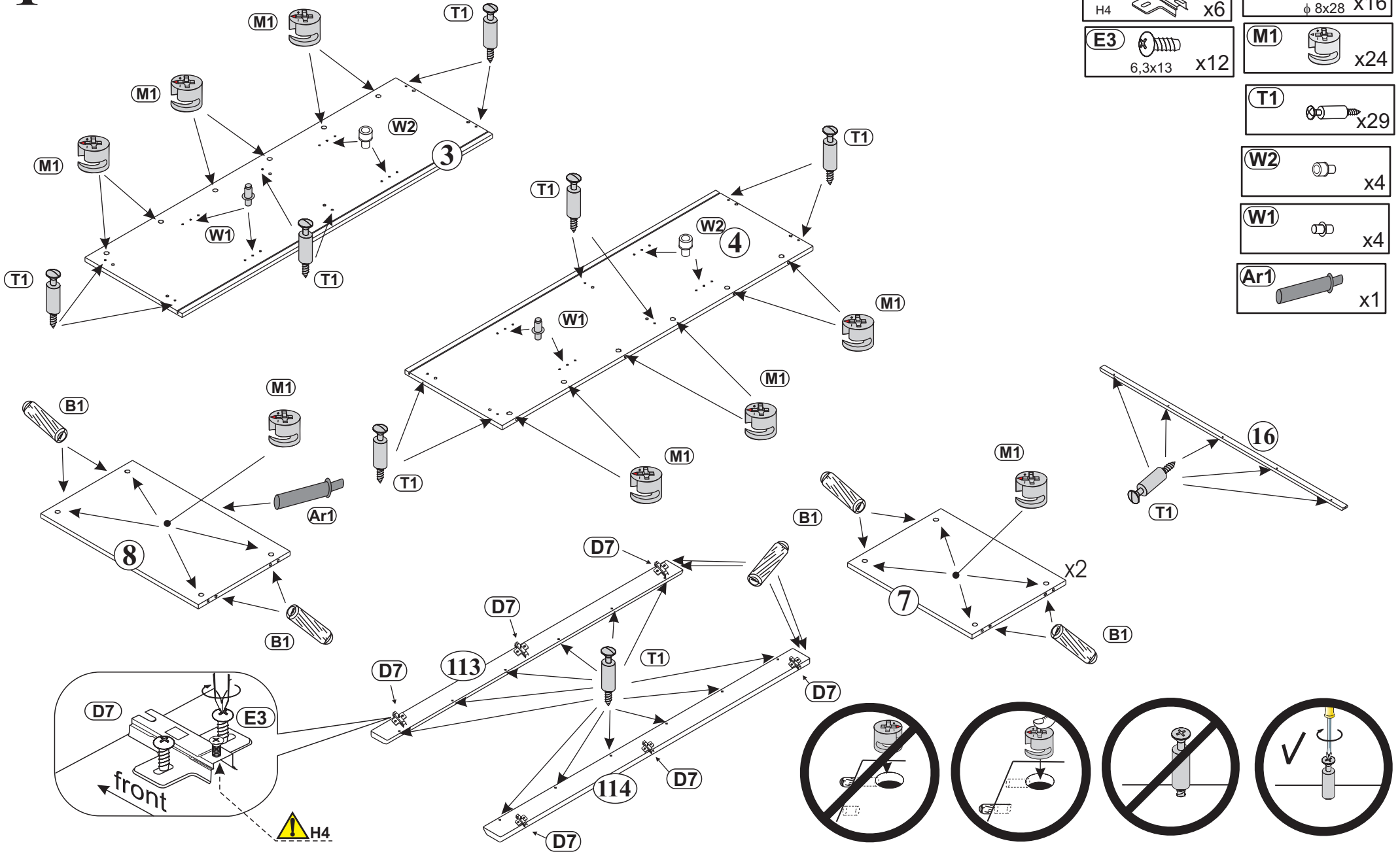

D7
H4  x6

B1
 ϕ 8x28 x16

E3
6,3x13 x12

M1
 x24

T1
 x29

W2
 x4

W1
 x4

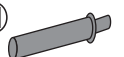
Ar1
 x1

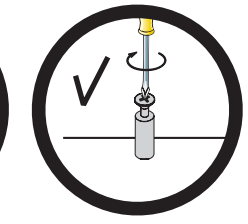
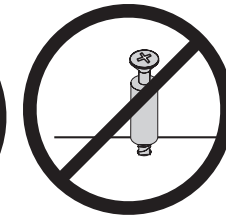
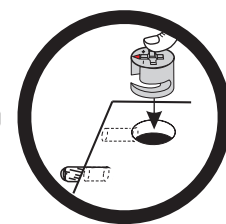
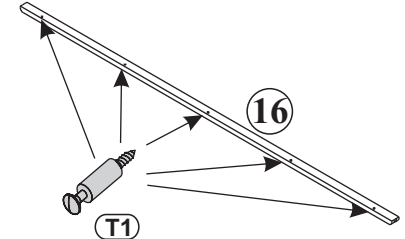

2

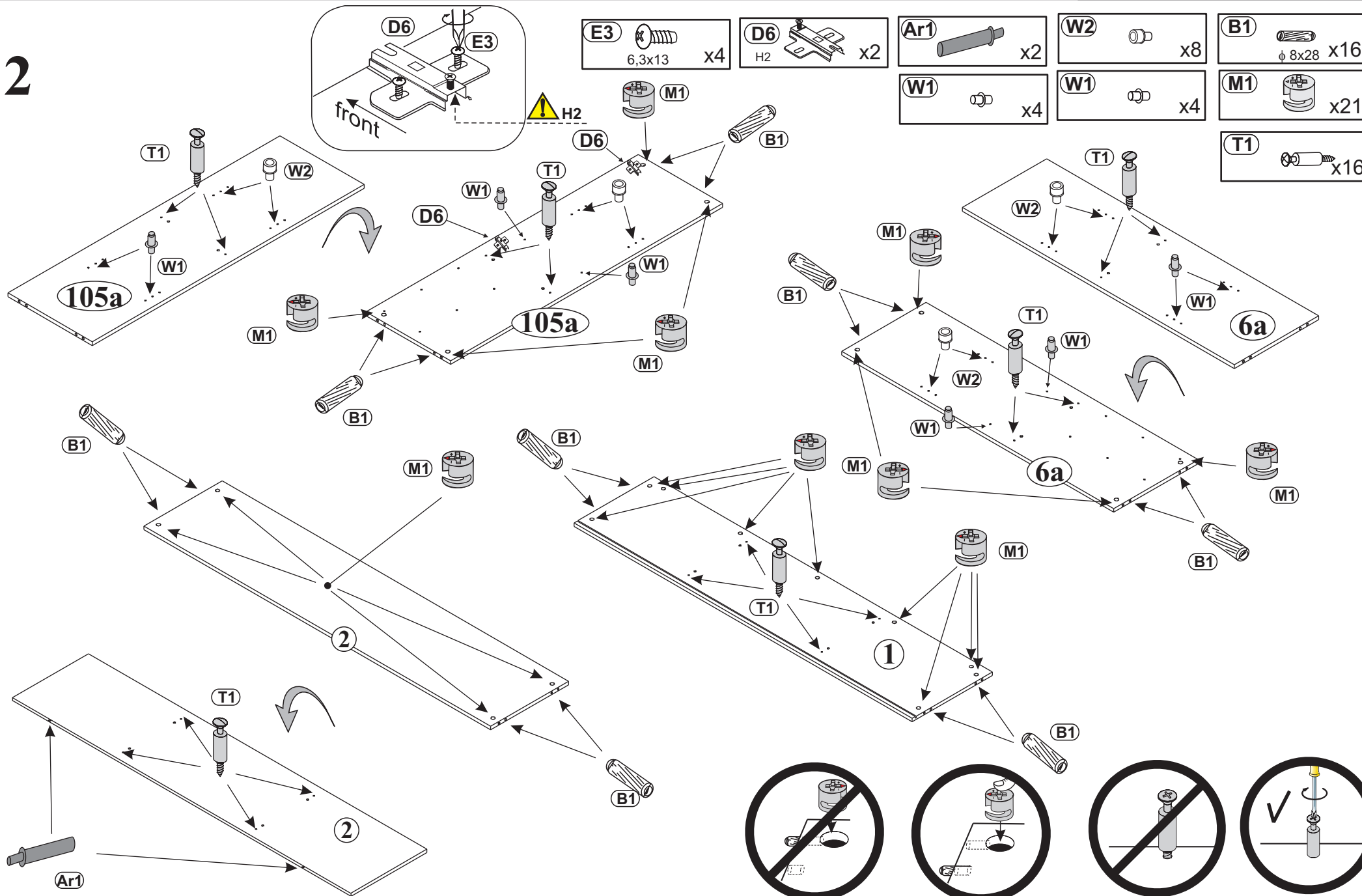

Modellname:
Nazwa modelu:

Nature Plus

Modellreihe:
Numer modelu:

1205FF22

Type:
Typ:

22

Blatt Nr
Strona

6

von:
z:

8

3

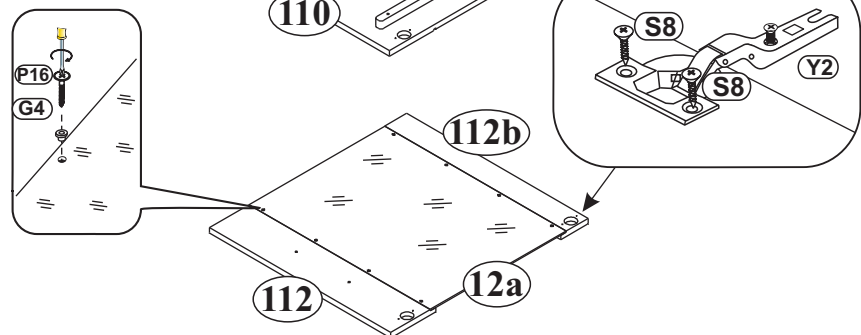
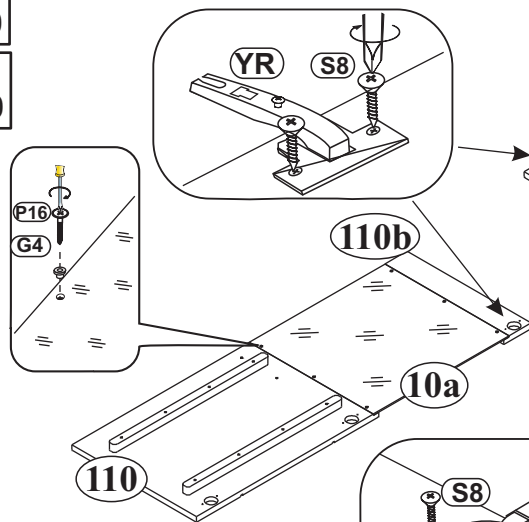
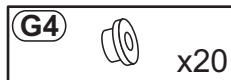
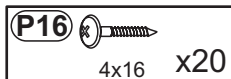
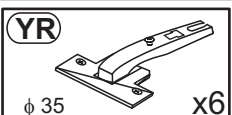
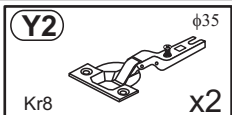
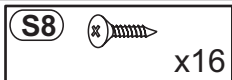

4

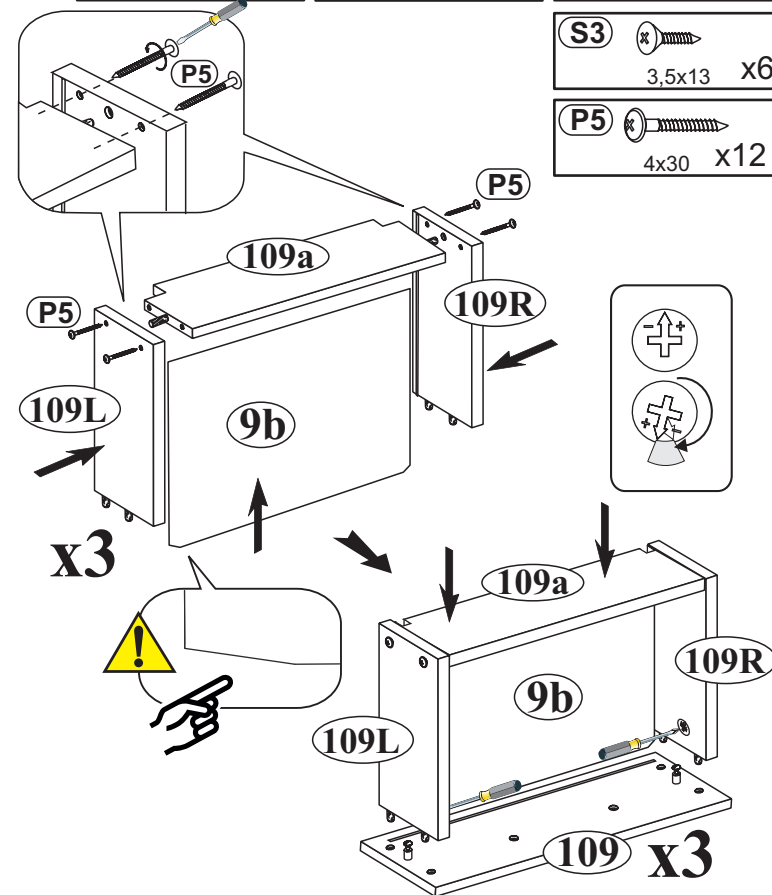
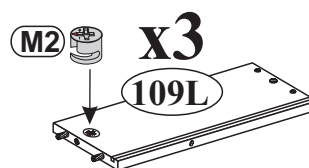
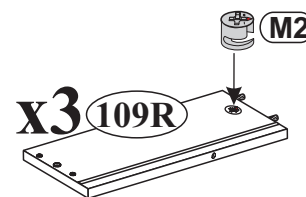
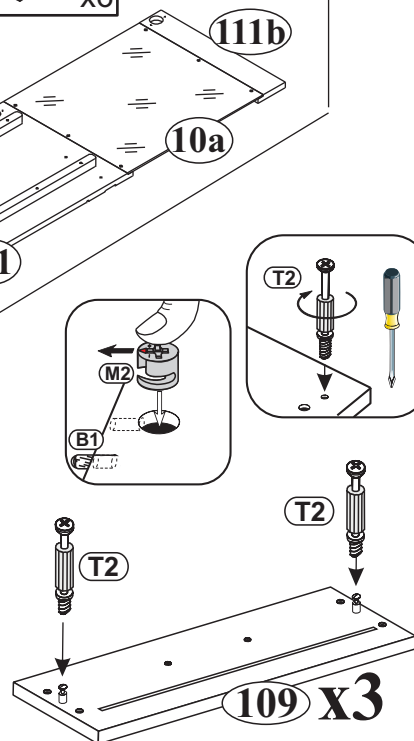
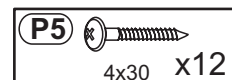
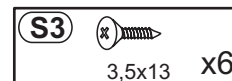
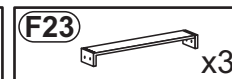
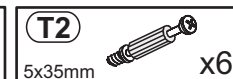
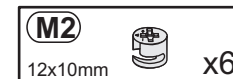

5

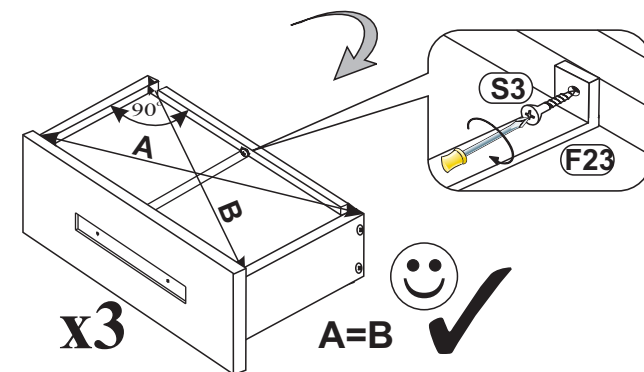
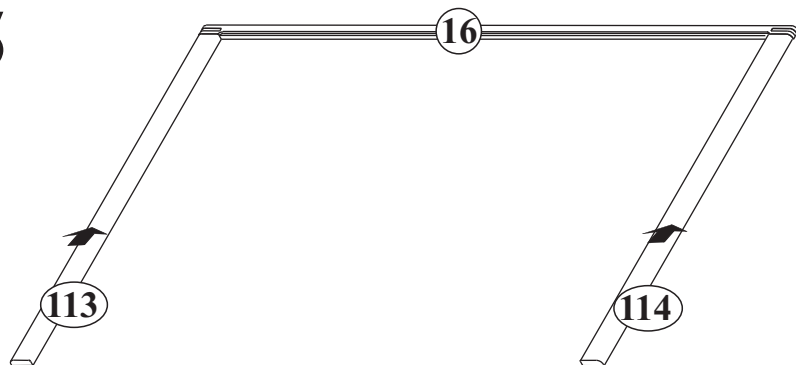

6

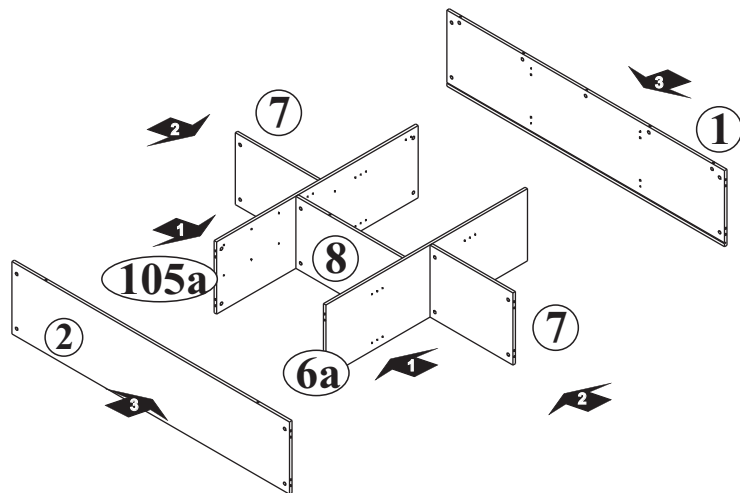

7

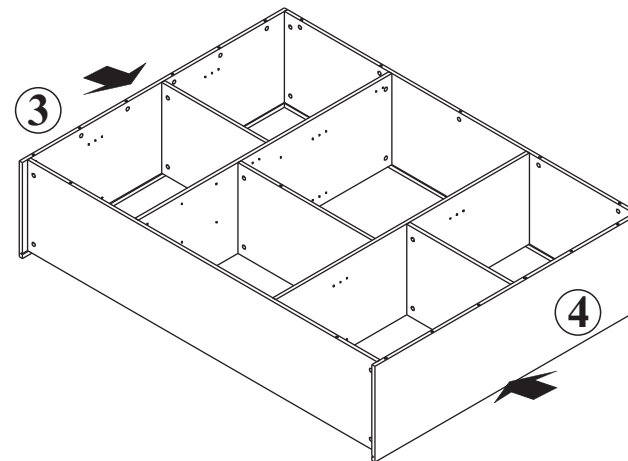

8

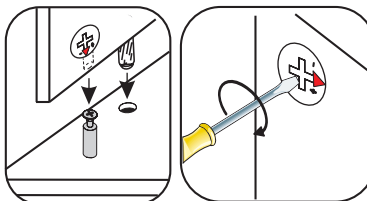
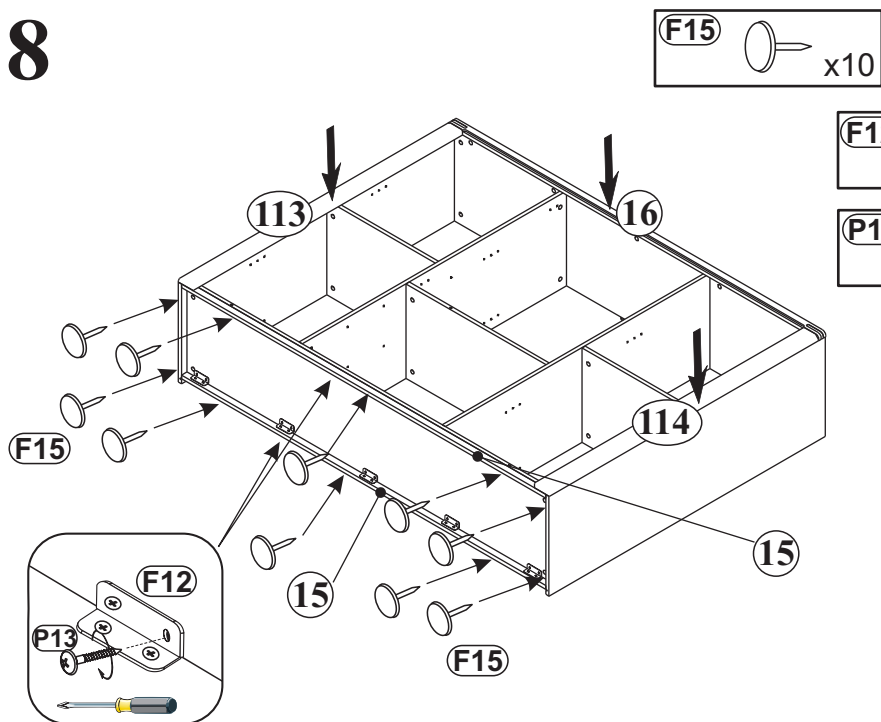

9

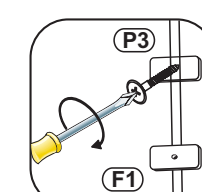
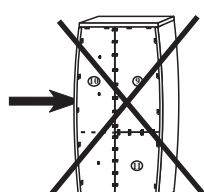
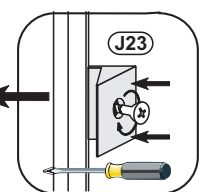
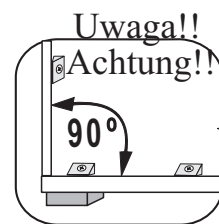
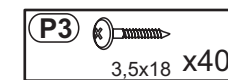
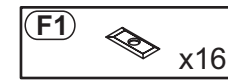
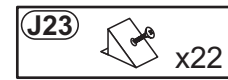
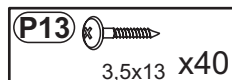
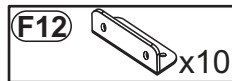
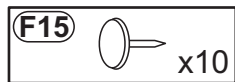
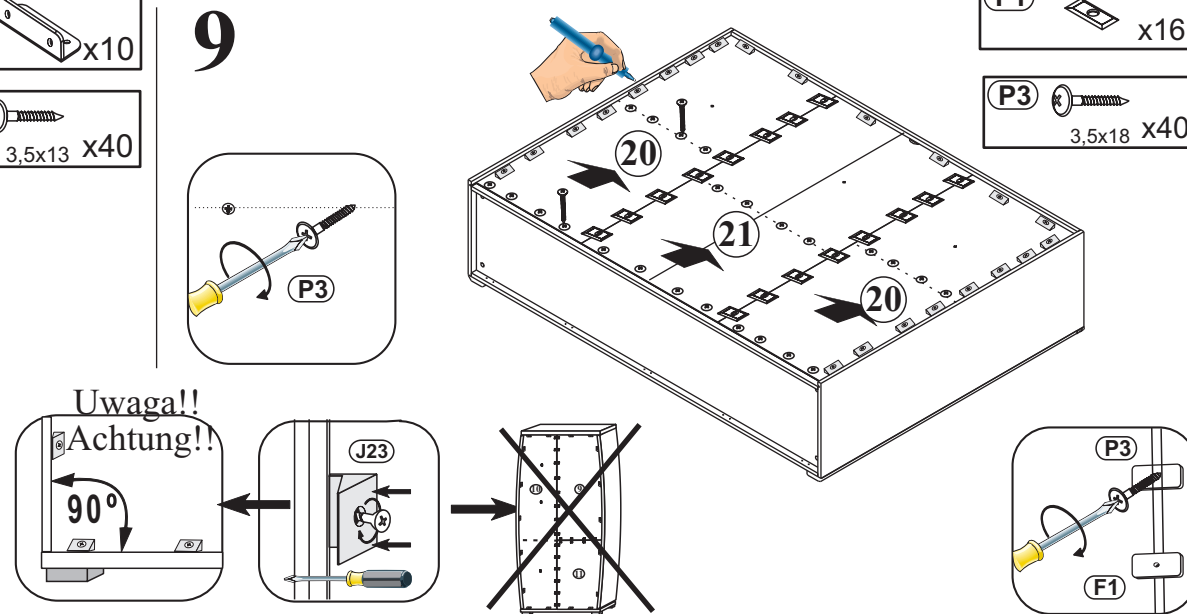

10

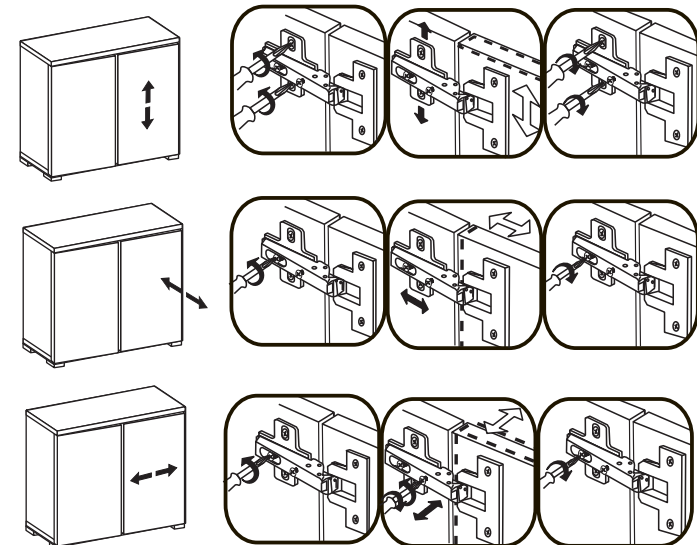
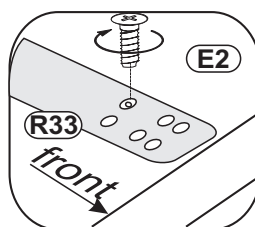
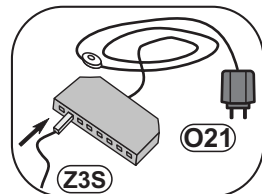
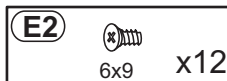
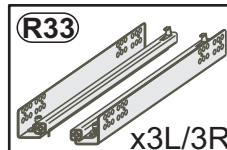
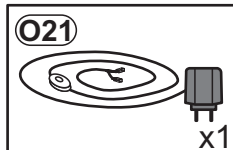
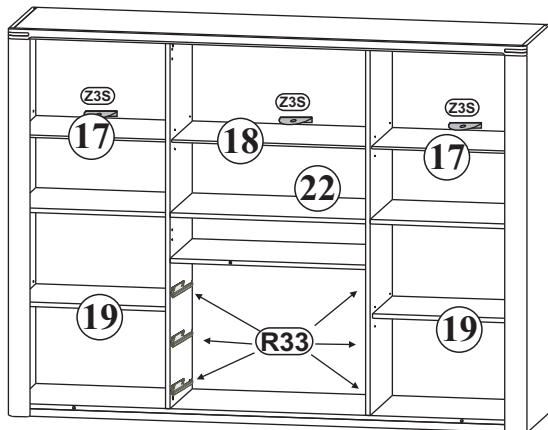

11

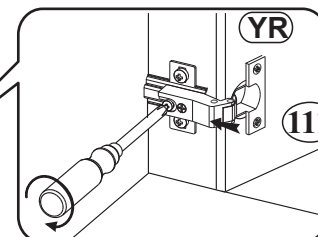
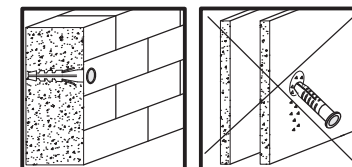
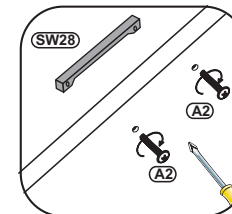
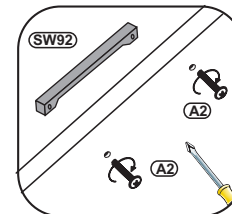
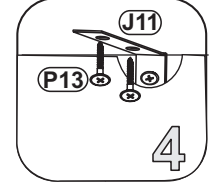
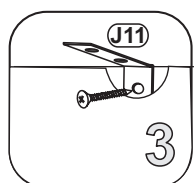
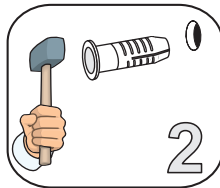
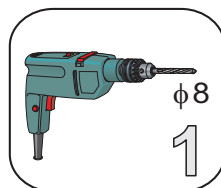
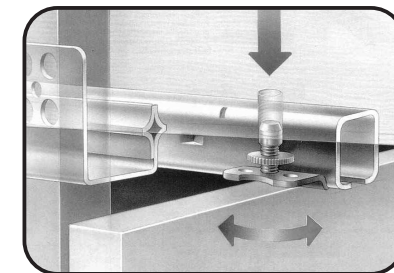
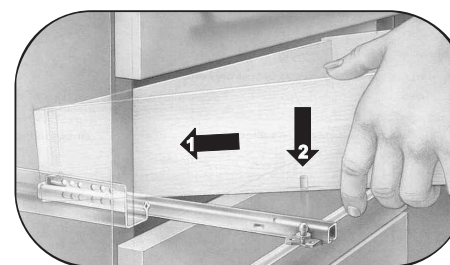
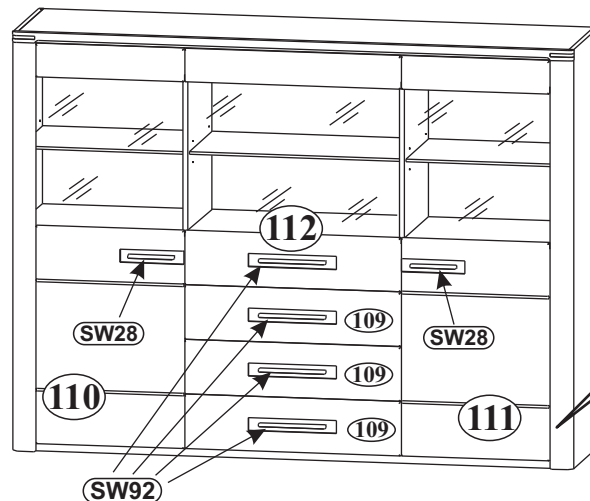
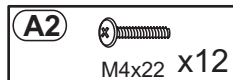
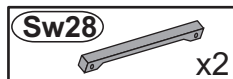
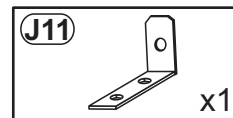
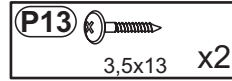
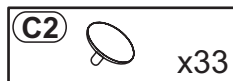
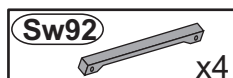
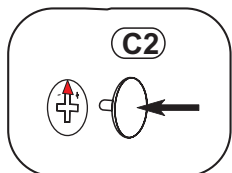

D CH AT LI LU Kleinstele und Verpackungsfolien bei der Möbelmontage von Kindern fernhalten!
GB US Keep small parts and plastic film out of the reach of children!
FR BE NC Tenir les petites pièces et les films plastiques hors de la portée des enfants!
NL Hou de kleine onderdelen en de plastic folie uit de buurt van kinderen!
IT Tenere i componenti di piccole dimensioni e le pellicole di plastica fuori dalla portata dei bambini!
SI Malhni delov i foliju za pakovanje priklom montaži pohištna priane izven dosega otrok!
XS HR BA Mahe dijelove i foliju za pakovanje priklom montaže namještaja držite dalje od djece
HU Bútorészeket közbden a kis alkatrészek és a csomagoló fóliák gyerekekkel távol tartandók!
BG Дребни детайли и опаковъчни фолия да се държат далеч от деца при монтажа на мебелите!
CZ SK Vid montáži nábytku uchovávejte drobné díly a obalové fólie z dosahu dětí!
SE Vid möbelföringen ska smådelar och förpackningsfolien hållas oåtkomliga för barn!
RO Țineți departe de copil piesele mici și folia de ambalat la montarea mobiliei!
ES ¡Durante el montaje, mantenga alejados de los niños las piezas pequeñas y el material plástico de embalaje!

D CH AT LI LU Möbelmontage muss auf ebennem Untergrund erfolgen. Bei Wandmontagen immer geeignetes Befestigungsmaterial verwenden.
GB US Furniture must be assembled on a flat surface. For assembly to the wall only use suitable fixing materials.
FR BE NC Le meuble doit être monté sur une surface plane. Pour le montage mural, utilisez des accessoires de fixation adaptés au type de mur.
NL De meubels dienen op een vlakke ondergrond te worden gemonteerd. Voor wandmontage moeten geschikte bevestigingsmaterialen worden gebruikt.
IT Il montaggio dei mobili deve avvenire su un fondo piano. Per il montaggio si prega di utilizzare solo materiali adatti.
SI Pohištvo je treba montirati na ravni podlagi. Pri stenski montaži vedno uporabite pritrilveni material.
XS HR BA Namještaj se mora montirati na ravnoj podlozi. Kod montaže na zid uvijek koristite prikladan materijal za pričvršćivanje.
HU A bútorcszerelési silk felületen kell végezni. Falra szereléshez mindig megfelelő rögzítianyagot kell használni.
BG Материалът на мебелите да се извършва на равна основа. При стенен монтаж винаги да се използва подходящ крепежен материал.
CZ SK Montáž nábytku provádějte na rovném podkladu. Při montáži na stěnu používejte vždy vhodný příslušovací materiál.
SE Monteringen av möbeln måste göras på jämnt underlag. Vid väggmontering ska lämpligt uppfästingsmaterial användas.
RO Montarea mobiliei trebuie să se realizeze pe o pardoseală dreaptă. La montarea la perete utilizați întotdeauna material de fixare adecvat.
ES El montaje debe efectuarse sobre una superficie uniforme. En el montaje mural emplee siempre el material de fijación adecuado.

D CH AT LI LU Bitte beachten Sie die Montageanleitung. Halten Sie immer die angegebene Wattzahl ein. Verhindern Sie einen Hitzestau.
GB US Please observe the assembly instructions. Do not exceed the max. given wattage. Ensure that the heat is not allowed to build up.
FR BE NC Veuillez respecter la notice de montage. Respectez impérativement le nombre des watts maximal. Veillez à éviter toute accumulation de chaleur.
NL Lees a.u.b. de montagehandleiding door. Hou de beslist aan het max. opgegeven wattage. Zorg ervoor dat geen hittehuwling onstaat.
IT Attenersi alle istruzioni di montaggio. Rispettarsi rigorosamente il numero di watt max. indicato. Assicurarsi che non si verifichi un accumolo di calore.
SI Upoštevajte navodila za montažo. Vedno upoštevajte navedeno število vatov. Preprečite zastoj vročine.
XS HR BA Obratite pažnju! Vas pozor na uputu za montažu. Uvijek se pridržavajte navedenog broja vat. Izbjegavajte zastoj vrućine.
HU Vegye figyelembe a szerelési útmutatót. Mindig tartsa be a megadott wattszámot. Akadályozza meg a hőelődést.
BG Моля, вземете под внимание ръководството за монтаж. Спазвайте винаги посочените ватове. Избягвайте акумулиране на топлина.
CZ SK Dodržujte prosím návod k montáži. Vždy dodržujte uvedenou hodnotu výkonu (watt). Zabráňte tak přehřívání.
SE Följ monteringsanvisningen. Följ alltid angivet wattal. Undvik att hetta uppstår.
RO Respectați instrucțiunile de montaj. Respectați întotdeauna numărul de watt impus. Evitați acumularea de căldură.
ES Le rogamos que tenga presente las instrucciones de montaje. Respete siempre el número indicado de vatios. Evite la acumulación de calor.

D CH AT LI LU Halten Sie die max. zulässigen Belastungswerte der Möbelteile ein. Details siehe Montageanleitung
GB US Comply with the max. permissible loads. For details, please refer to the assembly instructions
FR BE NC Respectez les valeurs de charge max. admissibles des parties de meubles. Pour plus de détails, cf. la notice de
NL Hou de maximaal geoorloofde belastingswaarden van de meubeldelen aan. Voor details verwijzen wij naar de montagehandleiding
IT Rispettare la portata max. permessa degli elementi del mobile. Per dettagli si vedano le istruzioni di montaggio e si vada
SI Upoštevajte največjo dovoljeno obremenitev delov pohištna. Podrobnosti najdete v navodilih za montažo in na
XS HR BA Tartsa be a bútorelemek max. megengedett terhelési értékét. A részleteket lásd a szerelési útmutatóban
HU Snaazajite makc. dopustimite stroynosti na natovaravne na mebelite. Za podrobnosti vizj ръководството за монтаж
BG Додръжте max. prípustnê hodnoty zátizení nábykových dílů. Podrobnosti viz návod k montáži
CZ SK Dodržujte max. přípustnê hodnoty zátizení nábykových dílů. Podrobnosti viz návod k montáži
SE Följ max. tillåten belastning av möbeldelarna. Mer information finns i monteringsanvisningen
RO Respectați valorile de solicitare max. admise pentru corpurile de mobilier. Pentru detalii consultați instrucțiunile de montaj
ES Respete los valores máximos de carga admisibles para las piezas de los muebles. Consulte los detalles en las instrucciones

D CH AT LI LU Zur Möbelfeinigung ein mit Wasser befeuchtetes, fusselfreies Baumwolltuch verwenden. Geeignigte Flächen immer trockenreiben!
GB US To clean the furniture only use a water dampened lint-free cotton cloth. Once cleaned, always wipe the surfaces dry.
FR BE NC Utilisez un chiffon en coton non pelucheux humidifié avec de l'eau pour nettoyer les meubles. Séchez systématiquement les surfaces
NL nettooyes en les froltant!
IT Gebrauk een met water bevochtigde, pluusvrije katoenen doek om de meubels te reinigen. Wrijf gereinigde oppervlakken altijd droog!
SI Per pulire il mobile utilizzare un panno di cotone inumidito d'acqua e che non perde pelucchi. Asciugare sempre le superfici che si sono
XS HR BA kromi!
HU Za čišćenje pohištva uporabljajte vlažno bombažno krpó, ki ne pušča vlaken. Očišćenje površine vedno obrišite do suhnega!
BG Za čišćenje namještaja koristite sa vodom navlaženu pamučnu krpú koja ne ispušta vlakna. Očišćenje površine uvijek obrišite suhom
CZ SK K čištění nábytku používejte bavlněný hadr neuvolňující vlákna, navlhčený ve vodě. Učištění plochy vždy utřete do sucha!
SE För möbelföring används en luddfri bomullsduk fuktad med vatten. Rengörda ytor ska alltid torkas torra!
RO Pentru curățarea mobiliei utilizați o lavetă din bumbac fără scame umezită cu apă. Suprafețele curățate se șterg întotdeauna până se usucă!
ES Emplee un paño de algodón humedecido con agua y libre de pelusa para la limpieza de los muebles. ¡Seque siempre las superficies que ha limpiado!