

# ZANDVOORT/TEXEL

160\_180

20160204

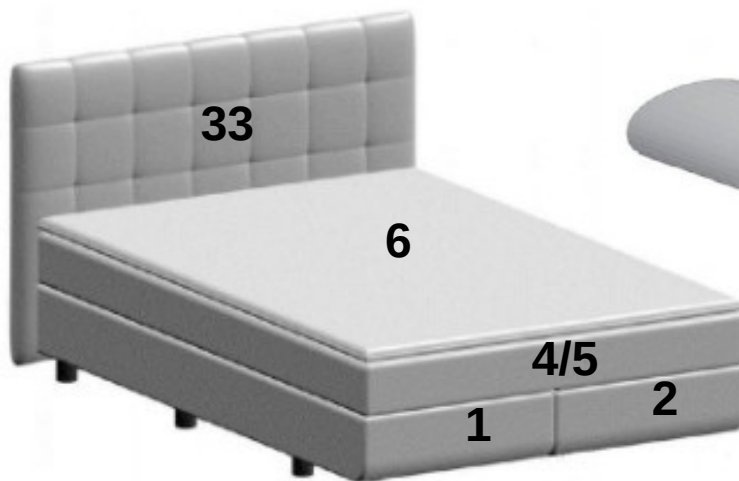
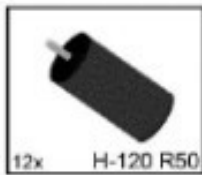
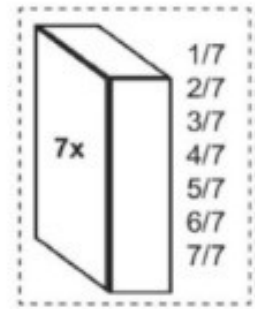

1/4

20190204

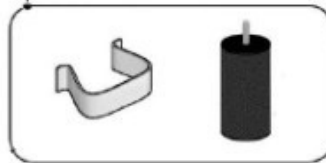
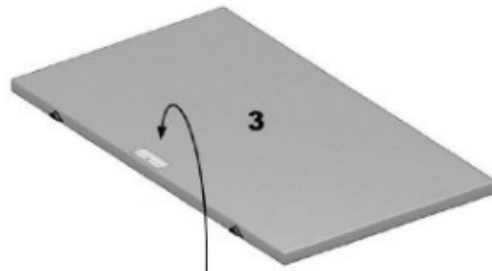

**1**

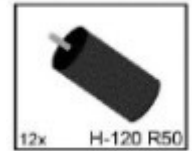
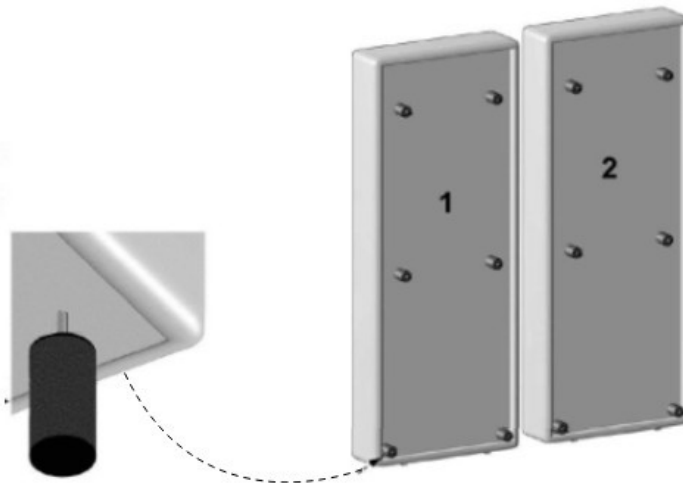

**2**

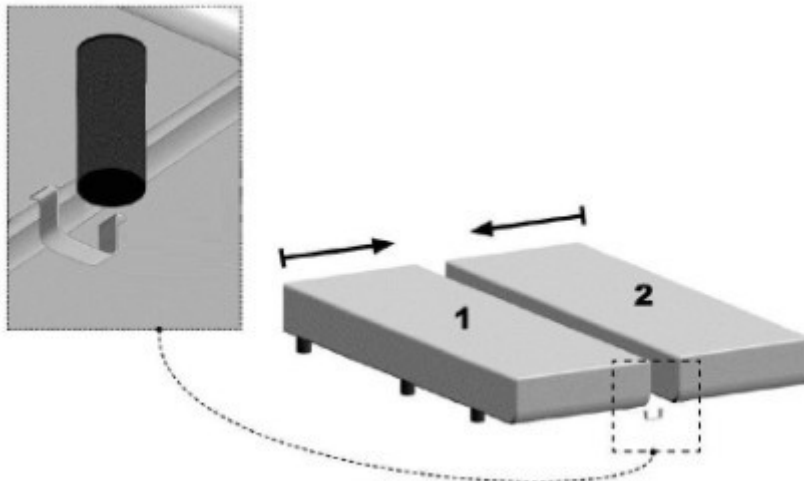

20190204

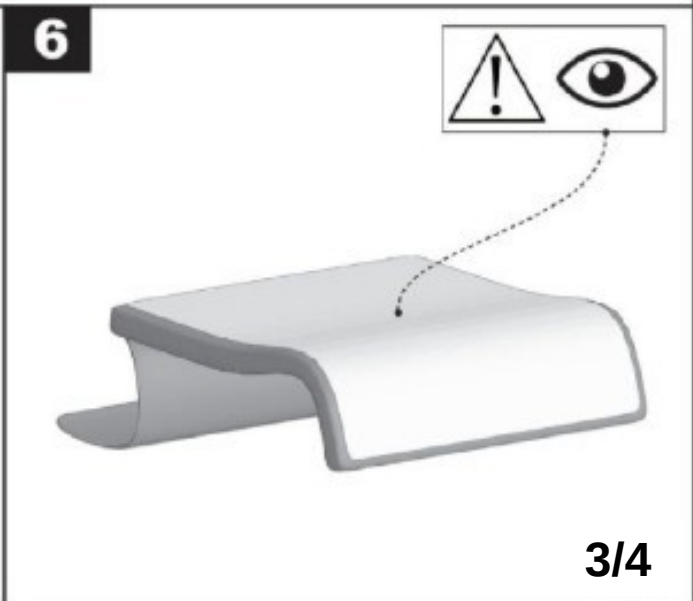
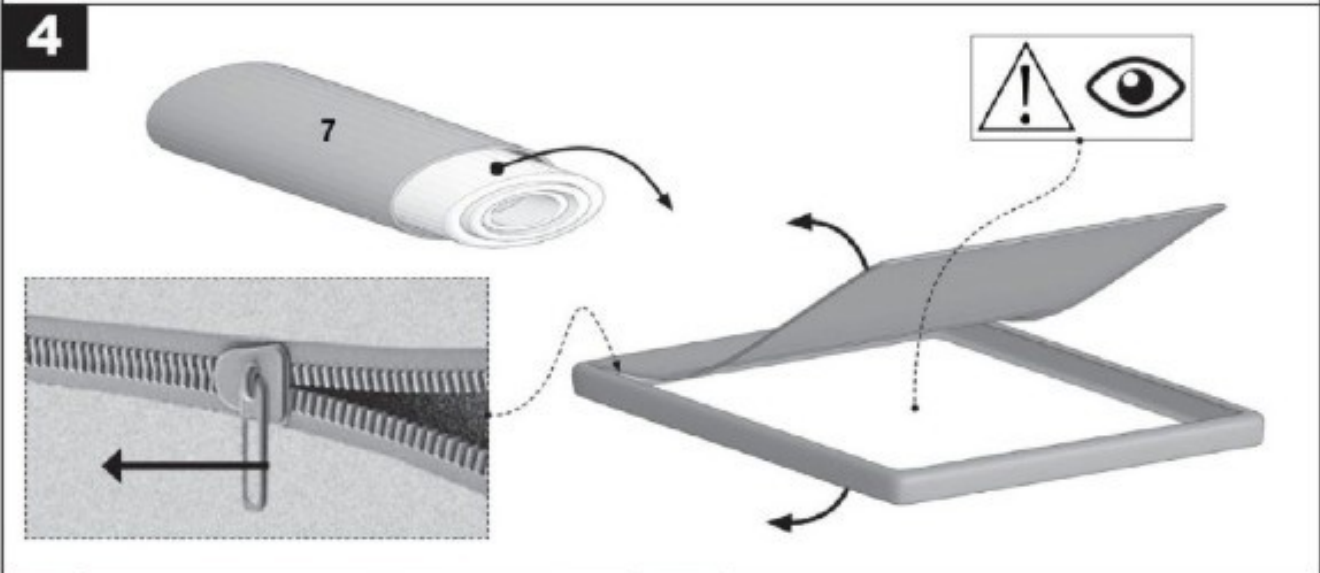
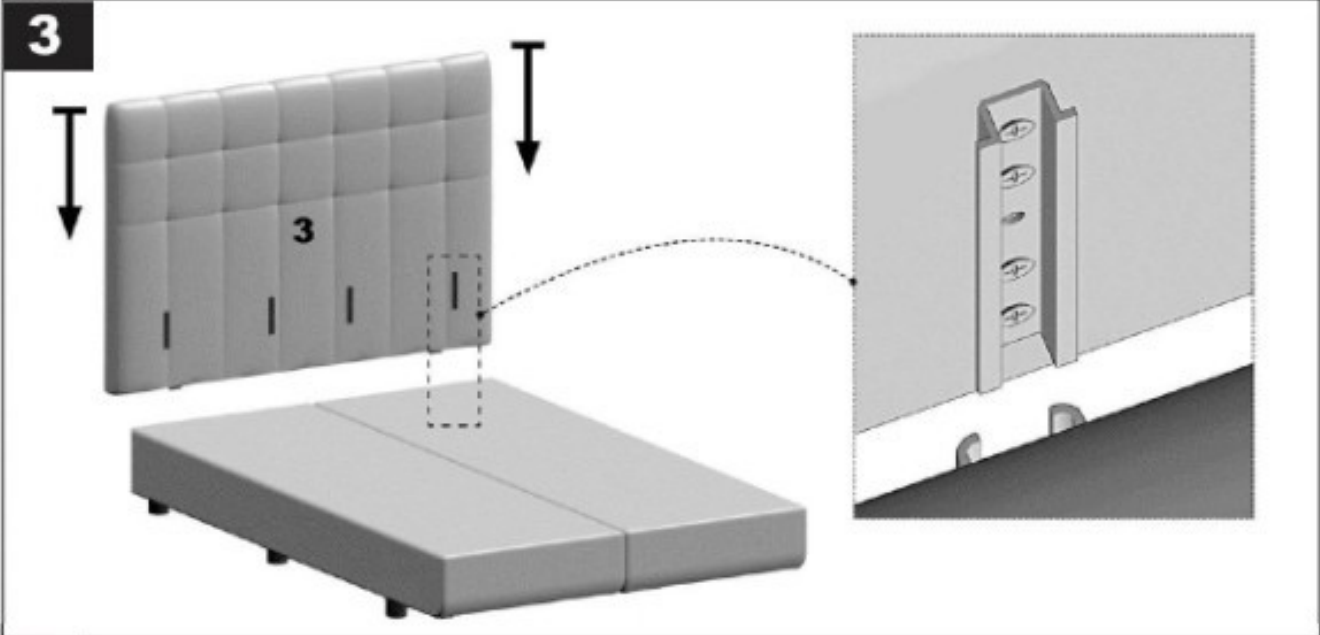

20201010

**7**



**8**

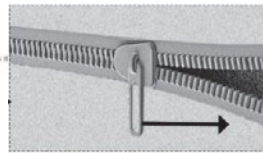
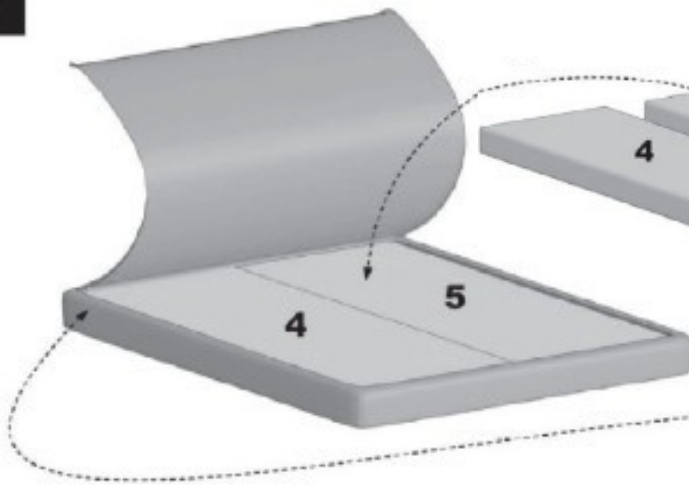

**9**



**10**

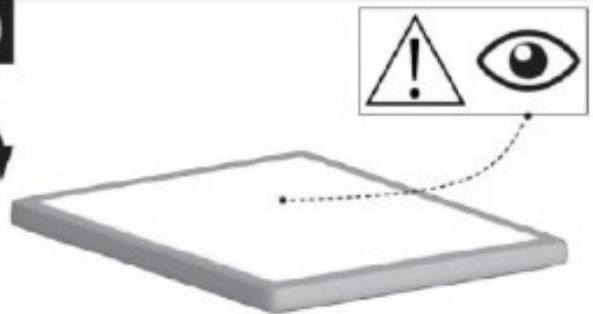

**11**



**12**

