

T1

Bitte unbedingt ausfüllen!

Name

Strasse

Plz

Ort

Tel.

T2

Sehr geehrte Kunden,
wir freuen uns, dass Sie sich für ein Produkt aus dem Hause Pelipal entschieden haben. Sollte es trotz aller Bemühungen unsererseits, Ihnen ein qualitativ hochwertiges Möbelstück zu liefern, zu Fehlteilen kommen, schicken Sie bitte dieses ausgefüllte Blatt an

Fax.: **+49 3443/434354**

E-Mail: **weisenfels.ersatzteile@pelipal.de**

Bitte beachten Sie, dass Bauteile über 800mm Länge und 350mm Breite direkt bei Ihrem Möbeldändler zu beanstanden sind. Zur Reklamationsbearbeitung ist es unbedingt erforderlich **die Artikelnummer des Schrankes**, welche auf dem Etikett ersichtlich ist und den Markt, wo das Möbel erworben wurde anzugeben. Außerdem tragen Sie unten bitte die benötigte Stückzahl ein. Viel Spaß mit Ihrem neuen Badmöbel! Ihr Pelipal Team

_____ - _____

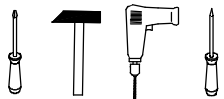









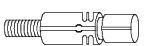

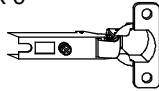

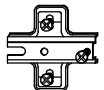

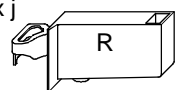
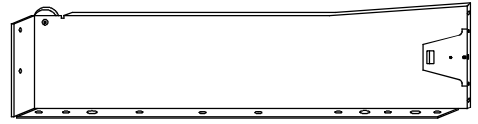
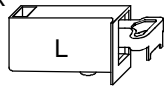

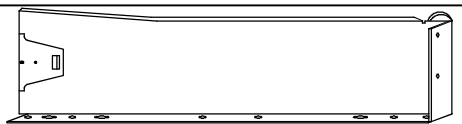



T3

Für den Zusammenbau sind 2 Personen erforderlich.

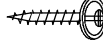
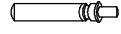
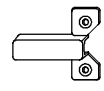
T4

Montage-Richtzeit 3 Stunden

16 x a  DUEB-SMD-000005	Stück	16 x b  EXZENTER-000015	Stück	4 x c  TBD-35-115X00	Stück	2 x f  2 x g 			
4 x d  ZPL-003X004	Stück	4 x e  TRAE-001-000020	Stück	1 x j  AUF-001-000080	Stück	2 x h 			
1 x k  AUF-001-000090	Stück	20 x l  SCH-SPA-035X015	Stück	4 x m  SCH-KA-063X011	Stück	2 x i  KA-SZ-270X085	Stück		
4 x n  SCH-KA-063X016	Stück	4 x o  ADK-AL1-005X008	Stück	4 x p  GRI-160-353010	Stück	8 x q  SCH-KNO-M04X020	Stück	20 x r  SCH-RDK-035X015	Stück
2 x s  AUF-001-000020	Stück	3 x t  DTS-15X2X4,9	Stück	3 x u  SCH-RWD-030X025	Stück	2 x v  TUER-DAEM-000010	Stück	2 x w  TUER-ADA-000010	Stück
4 x x  FSS-EF-CRG100E-311	Stück	16 x y  SCH-SPA-035X020	Stück	8 x z  DTS-20X4X6,5	Stück	16 x phi  NAGEL-025X001	Stück		Stück

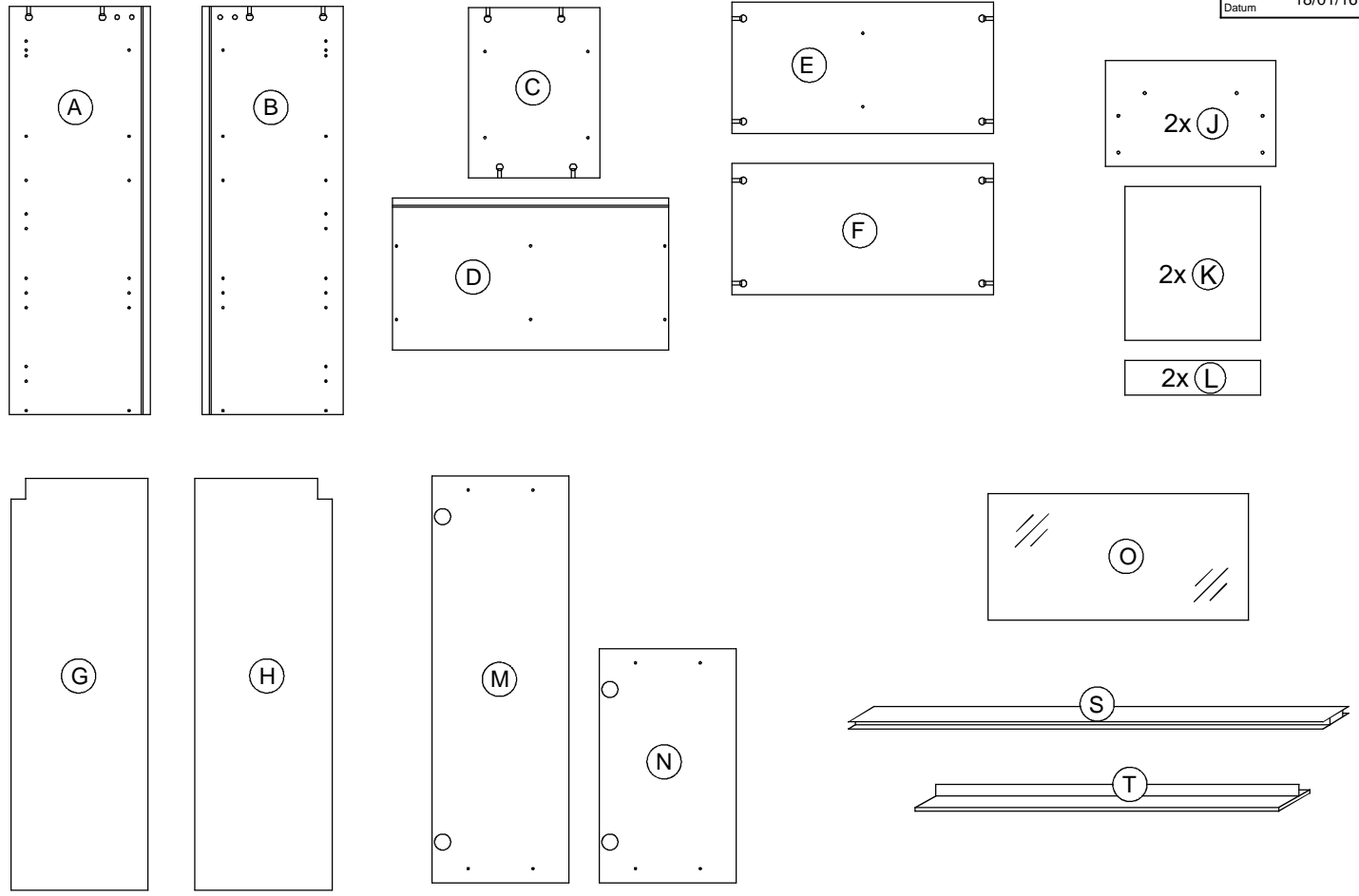

1.

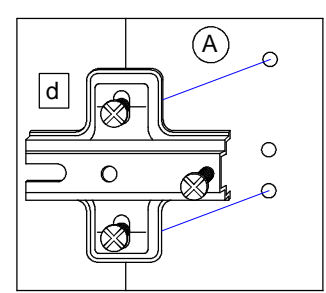
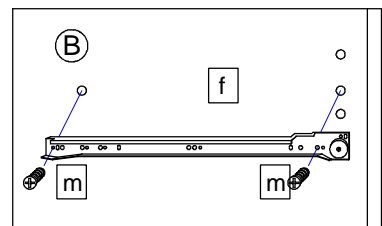
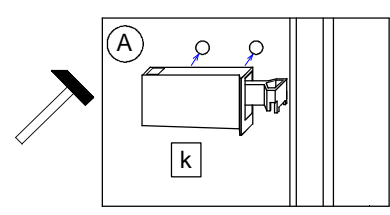
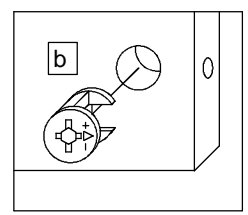
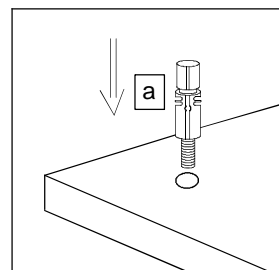
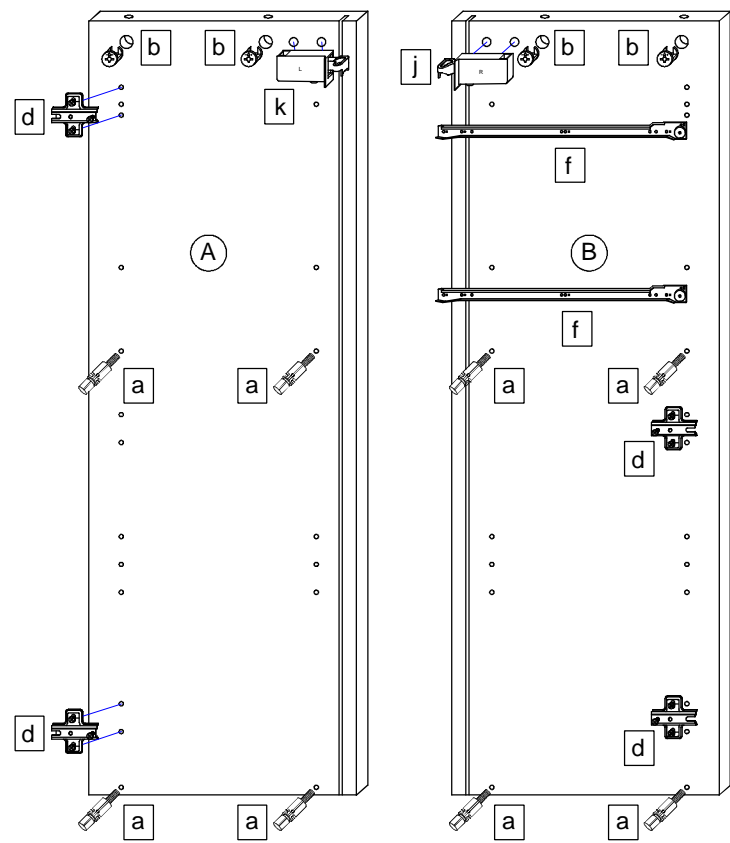
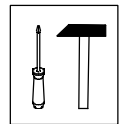

2.

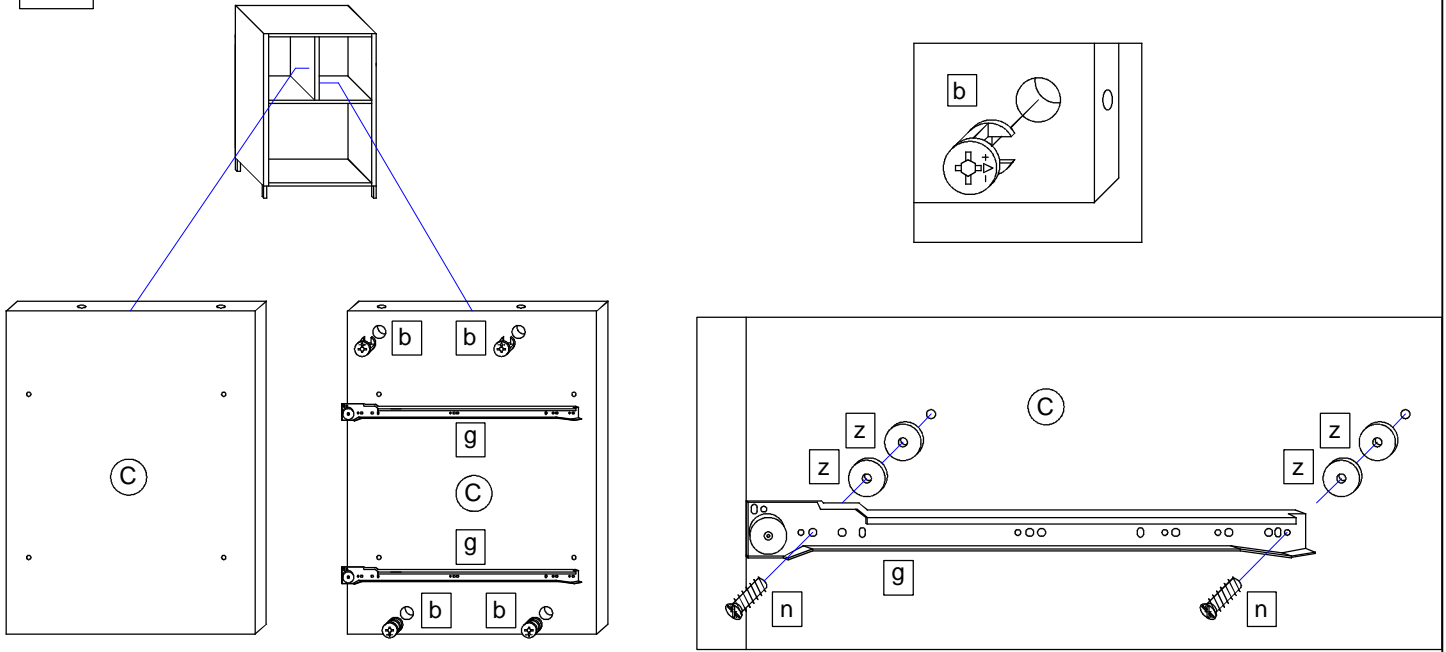
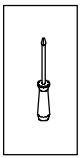

3.

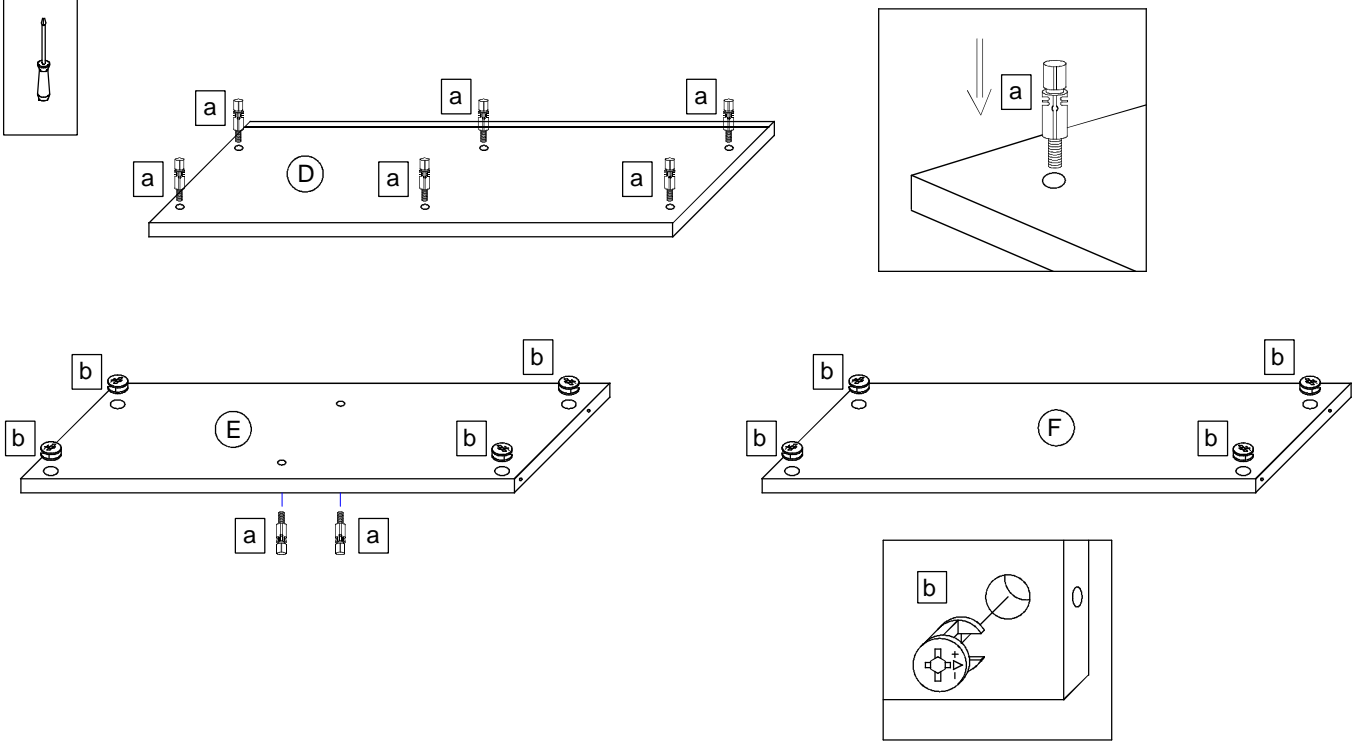
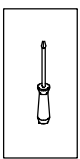

Das Etikett, welches sich unten rechts befindet bitte ausschneiden und auf der Rückwand mit Klebeband (nicht beiliegend) befestigen.



PELIPAL GmbH
 Hans-Wilhelm-Peters-Straße 2

33189 Schlangen
 Germany

4.

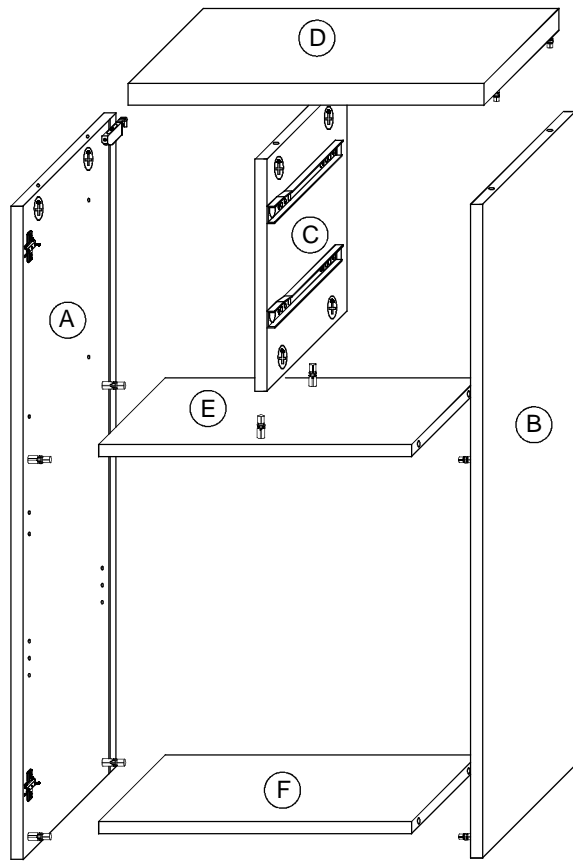
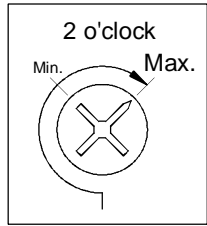
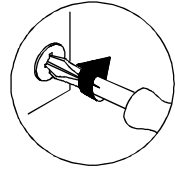
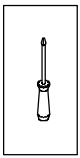

5.

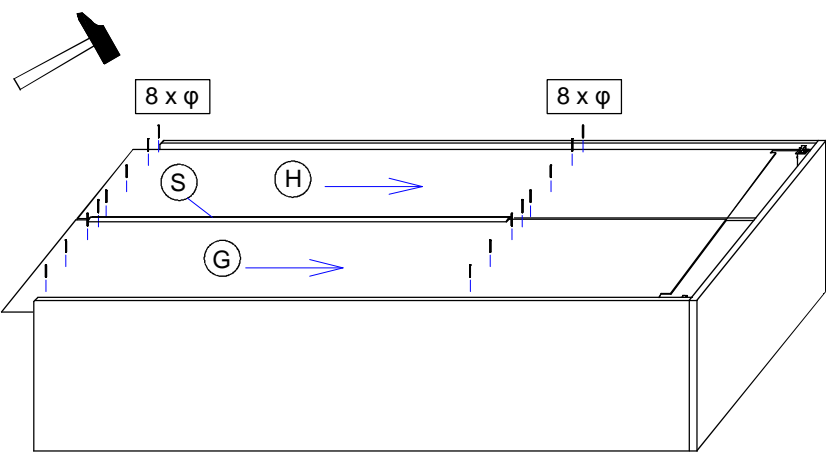
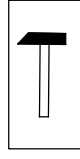

6.

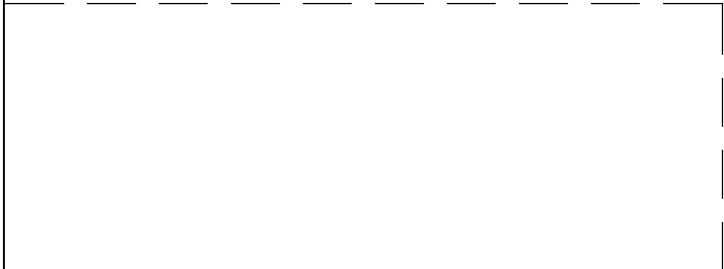
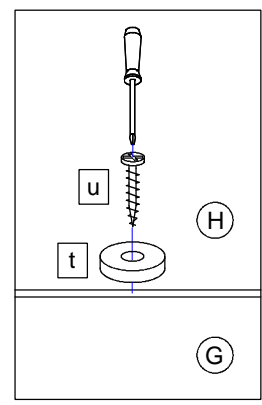
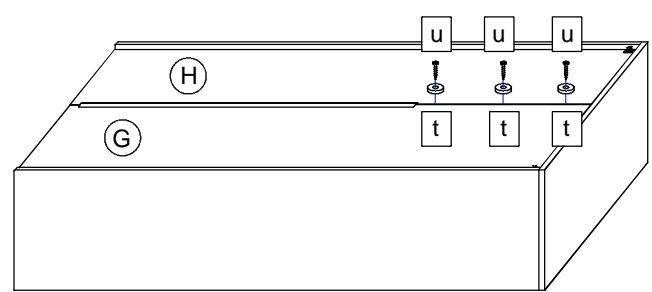
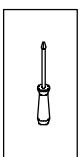

7.

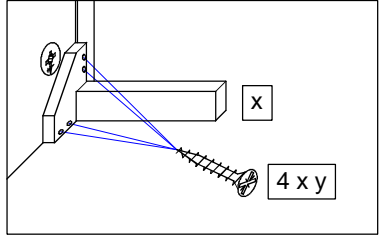
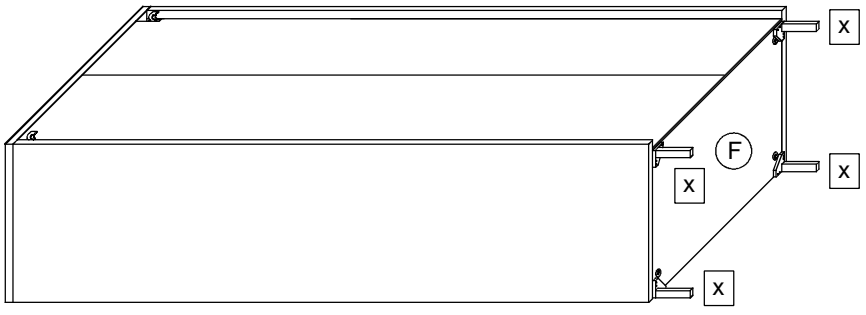
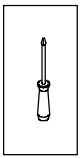

8.

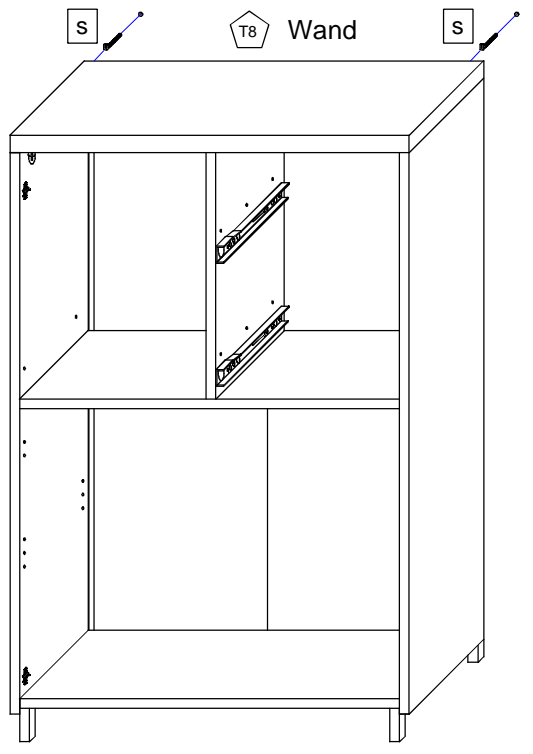
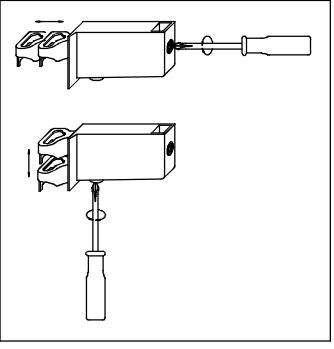
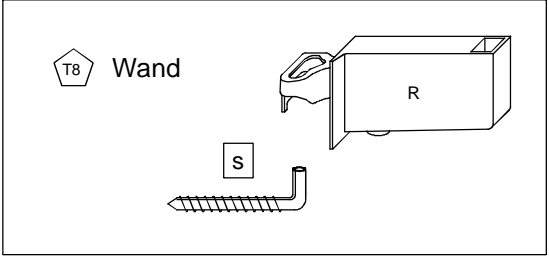
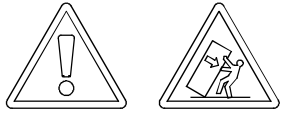
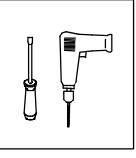

T9

Lassen Sie den Schrank nur durch fachkundige Personen mit für die Wand geeignetem Montagematerialien montieren.

T6

Die Schrankaufhänger dienen zur Kippsicherung des Schrankes und müssen grundsätzlich montiert werden.

9.

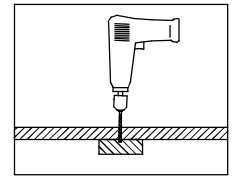
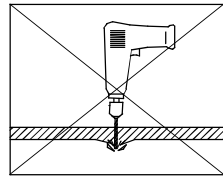
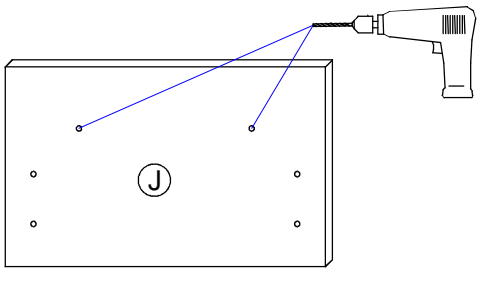
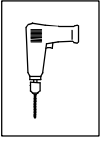

10.

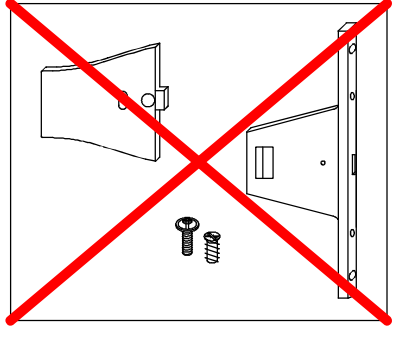
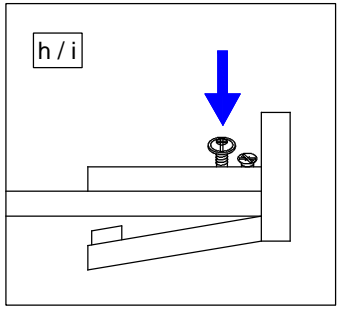
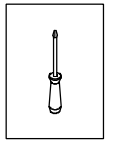

10.1

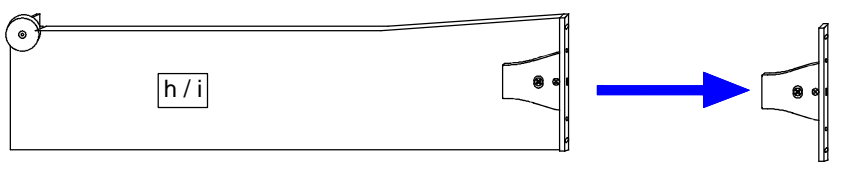

10.2

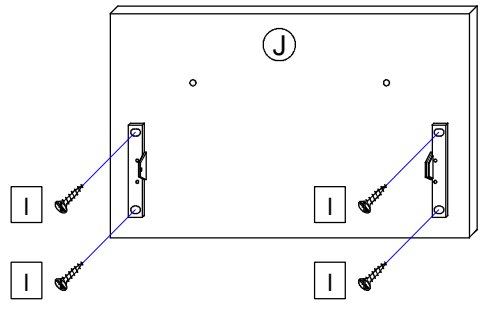

11.

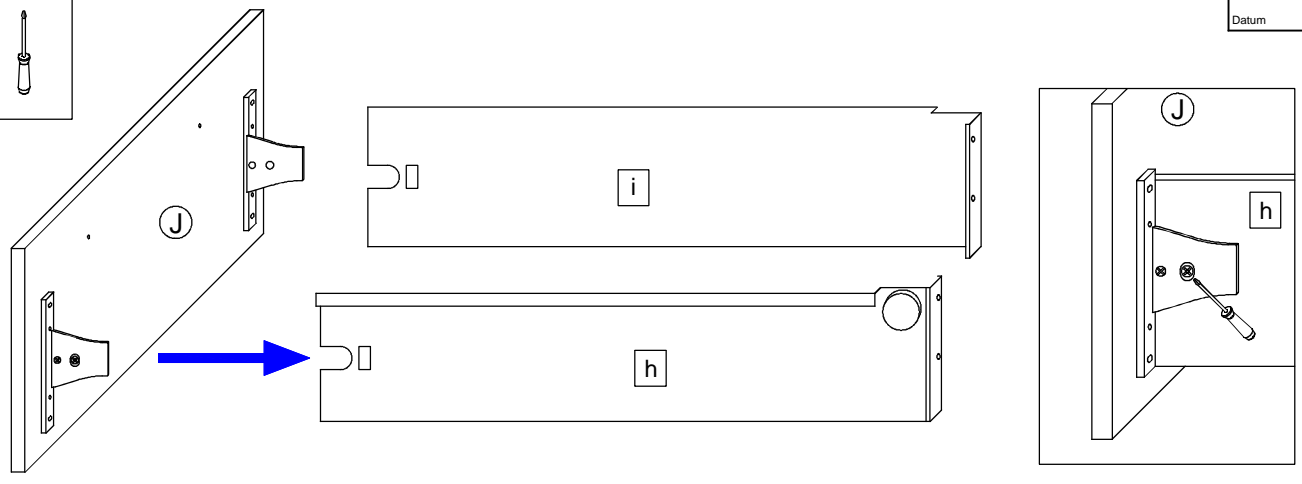
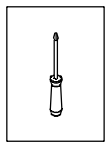

12.

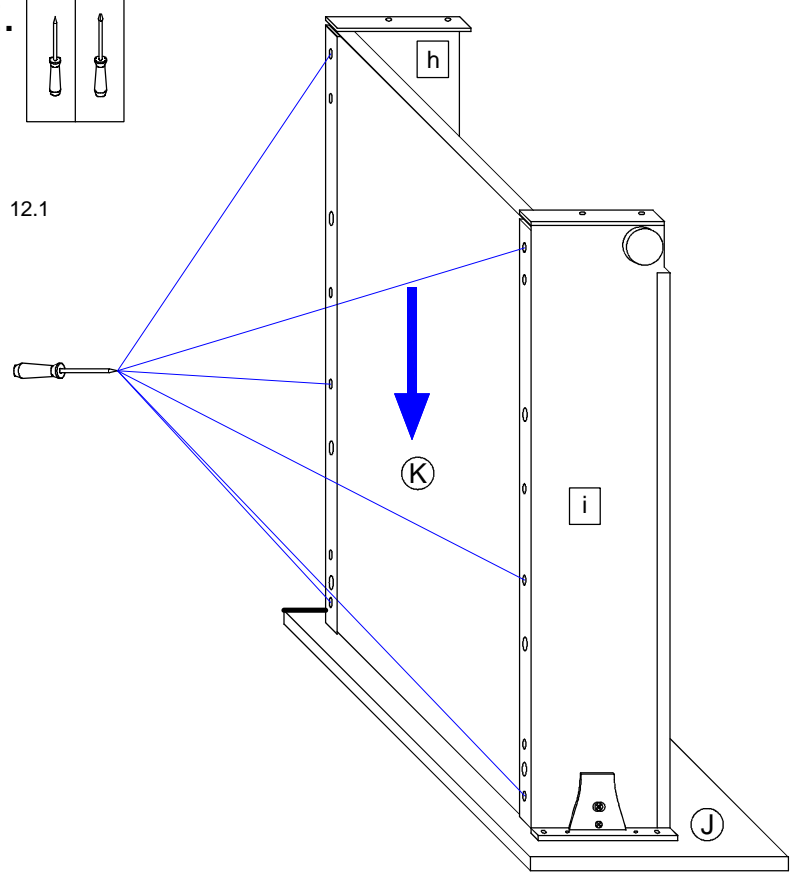
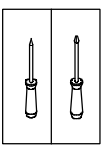

12.2

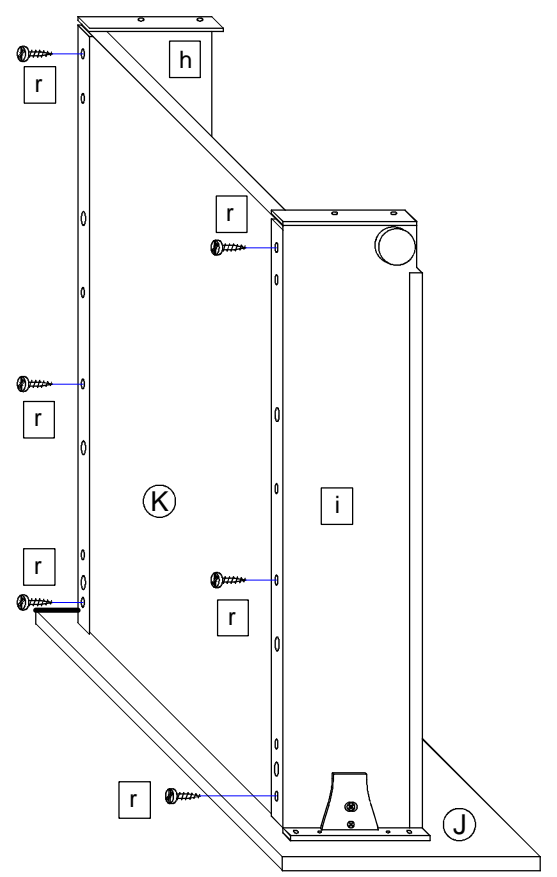

13.

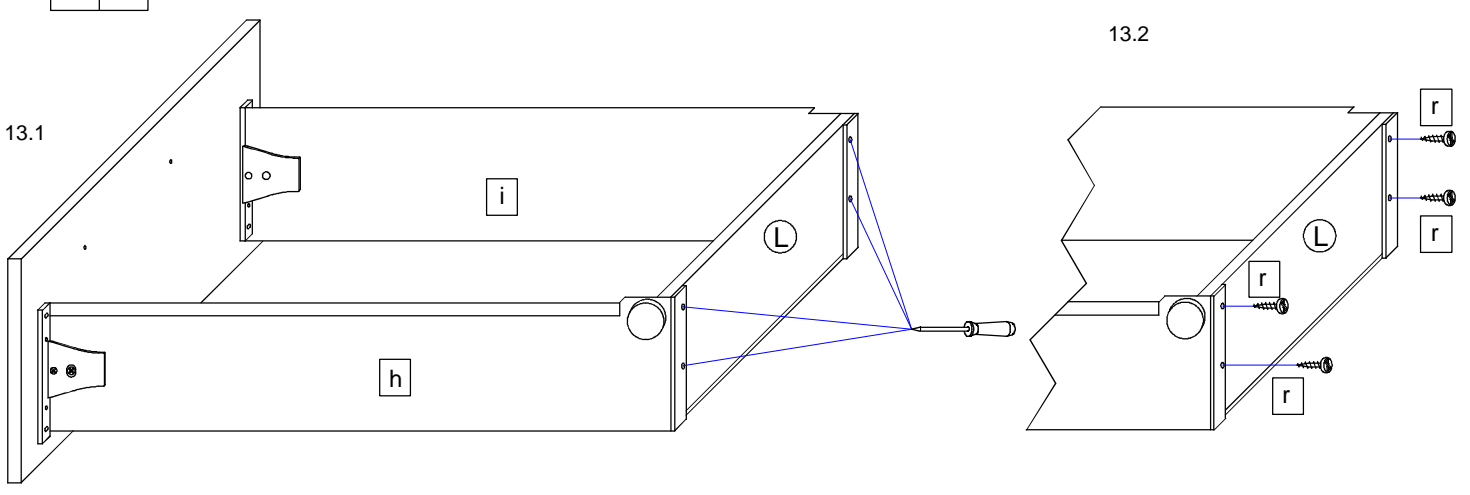
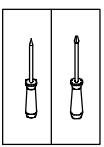

13.2

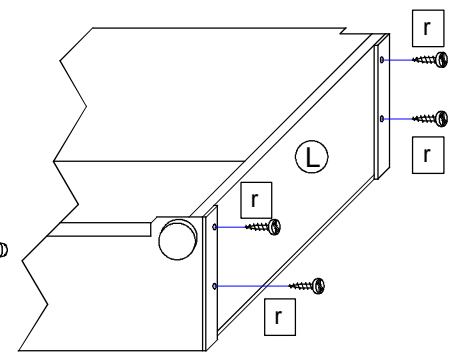

14.

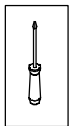

T10

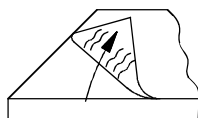

Bei Hochglanz-Fronten bitte erst die Schutzfolie entfernen und dann den Griff montieren!

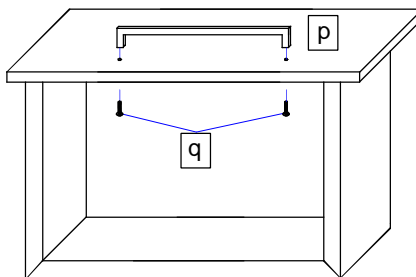

15.

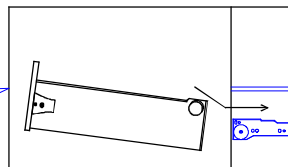
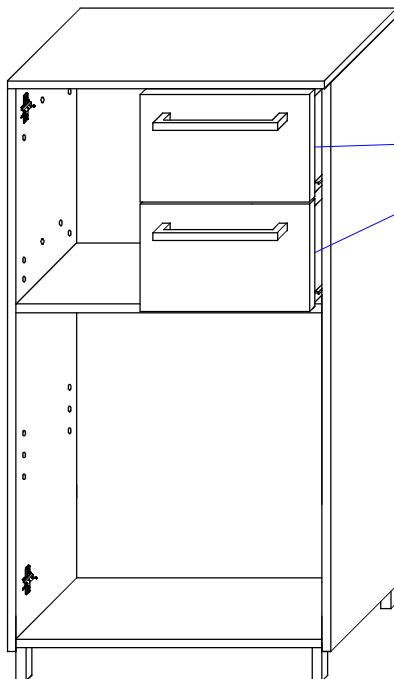

16.

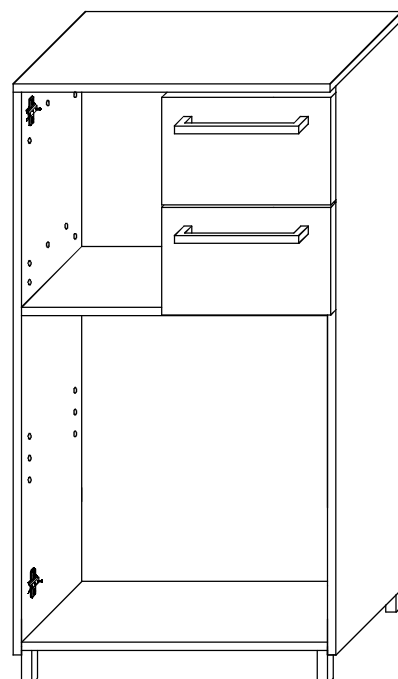
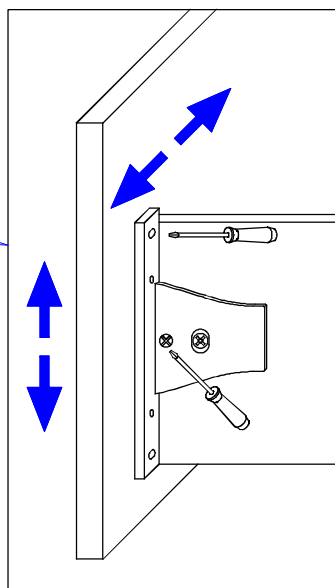
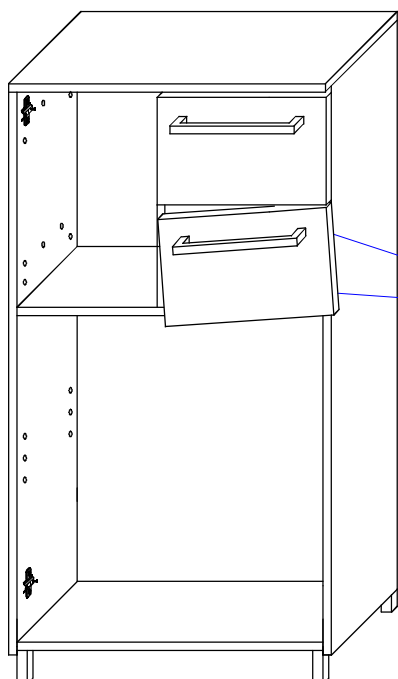
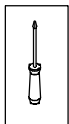

17.

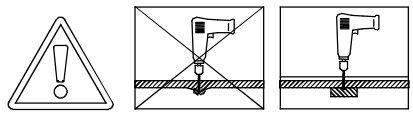
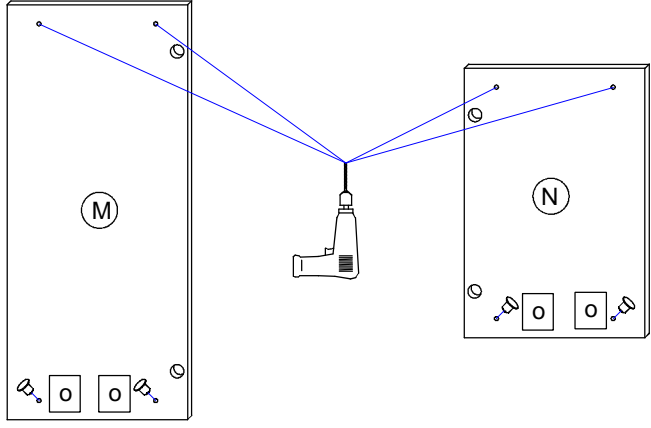

18.

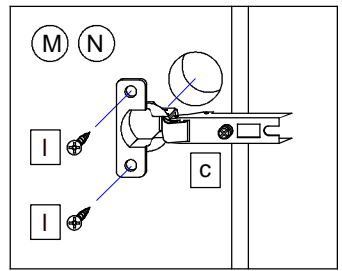
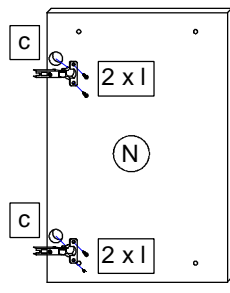
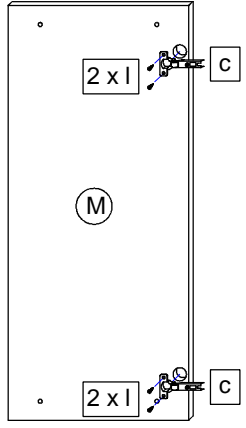
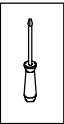

19.

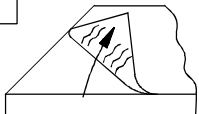
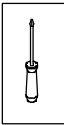

T10

Bei Hochglanz-Fronten bitte erst die Schutzfolie entfernen und dann den Griff montieren!

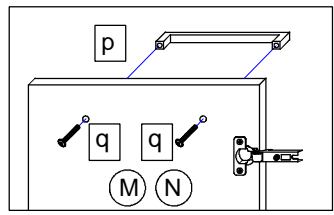

20.

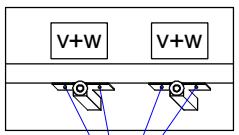
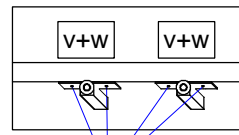
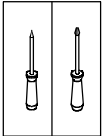

l
(3,5x15)

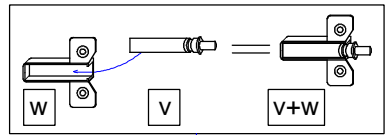

T11

Bei Türmontage das Scharnier einhängen, bis Anschlag öffnen und anschließend festschrauben.

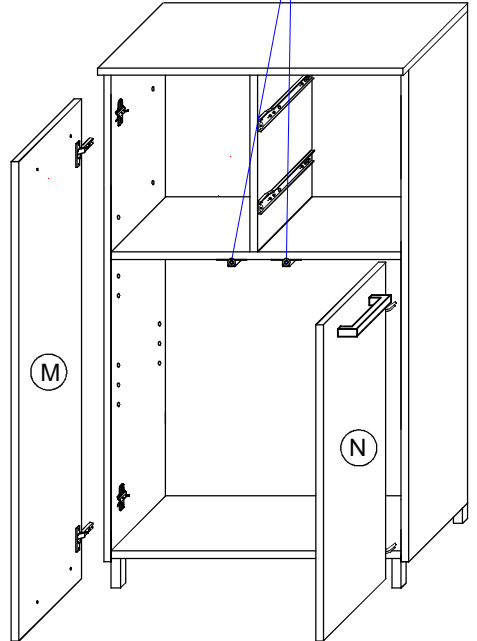
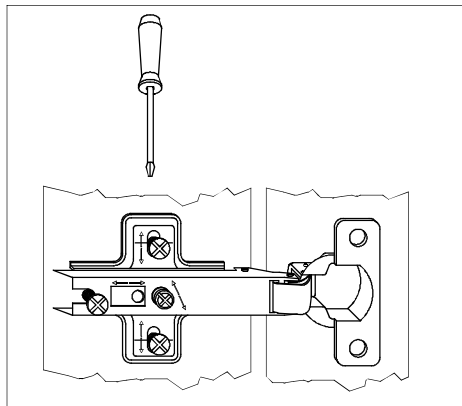
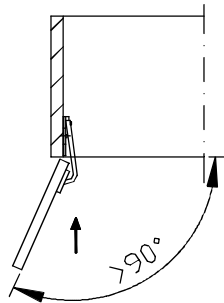

21.

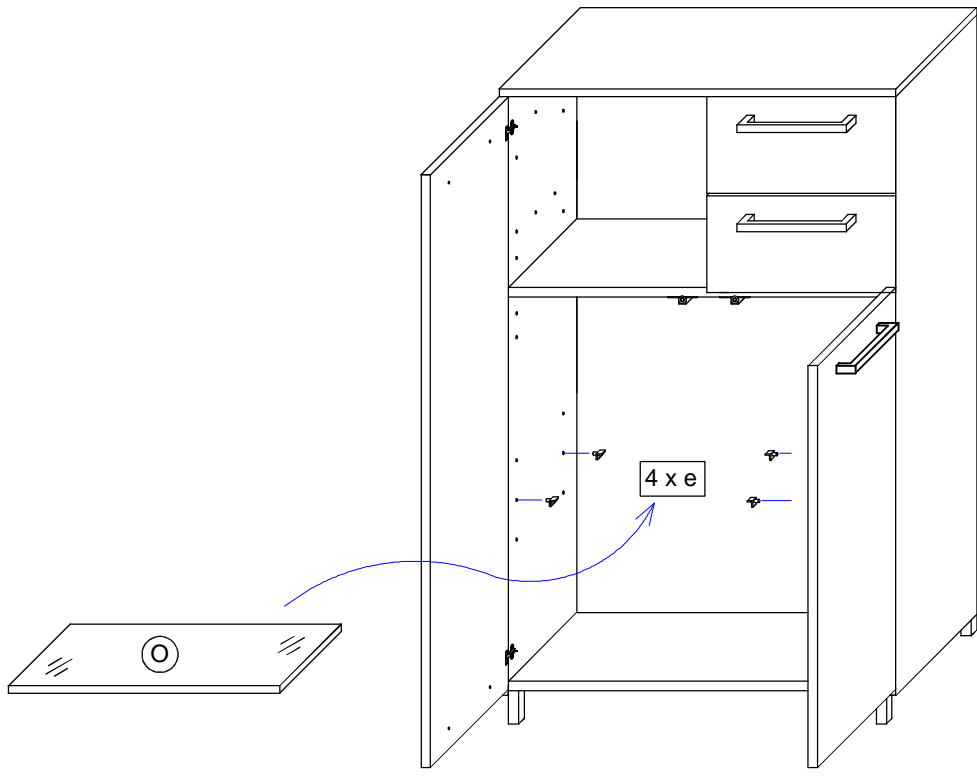

22.

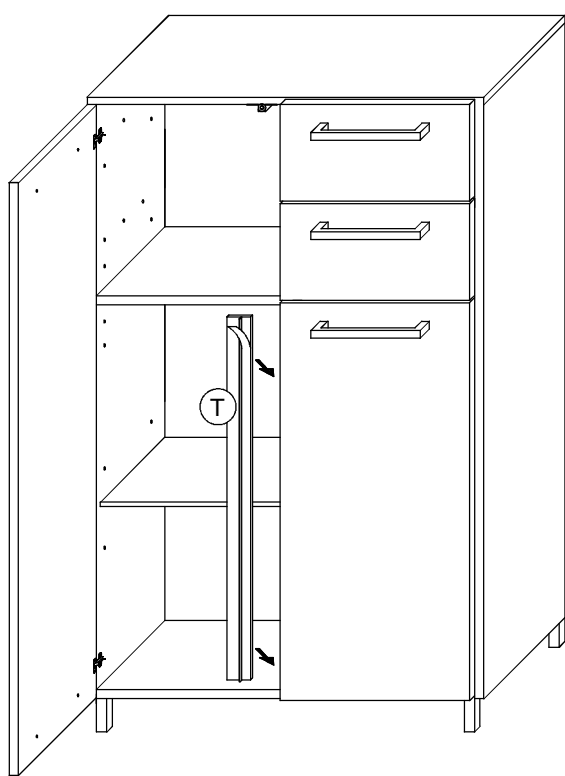

 Das Möbel bitte nur mit einem feuchten Tuch reinigen.