

*Nevis*  
*Art. Nr. 445193*  
*1/7*



5.02.2018

Art. Nr. 445193

Groundplan - Grundplan - Plan demasse -  
Planimetria - Plattegrond - Põhiplaan

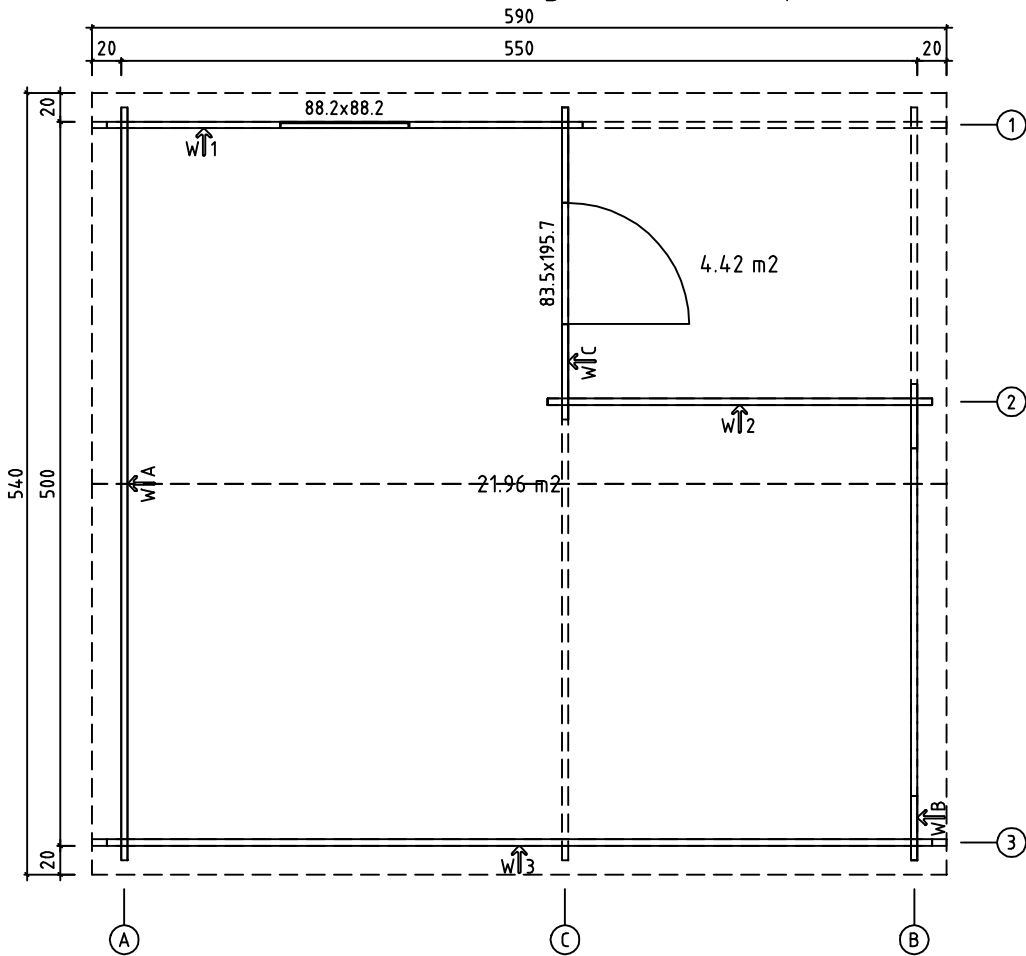

Foundation - Fundament - Fondation -  
Fondamenta - Fundering - Immutatud alusraam

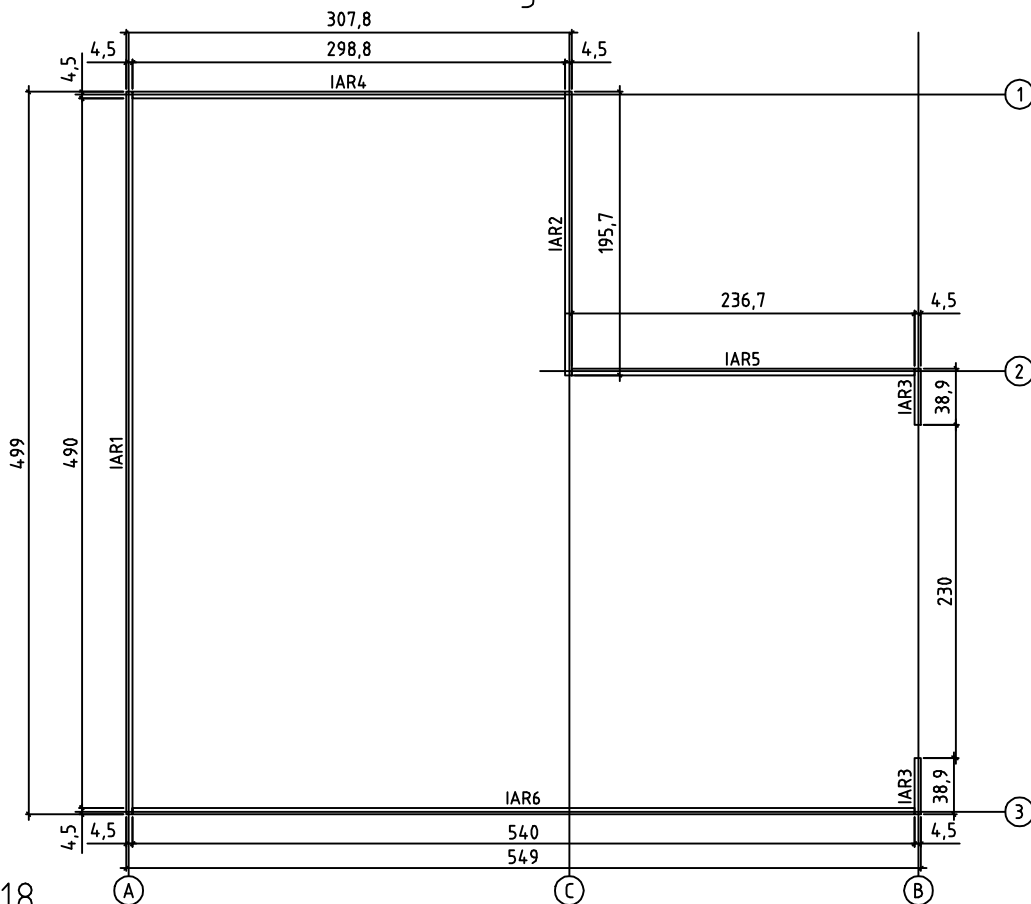

05.02.2018



2/7

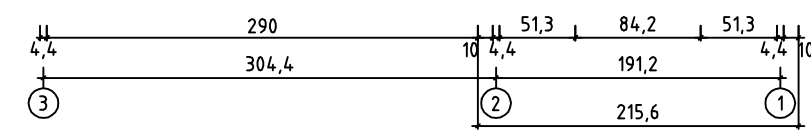
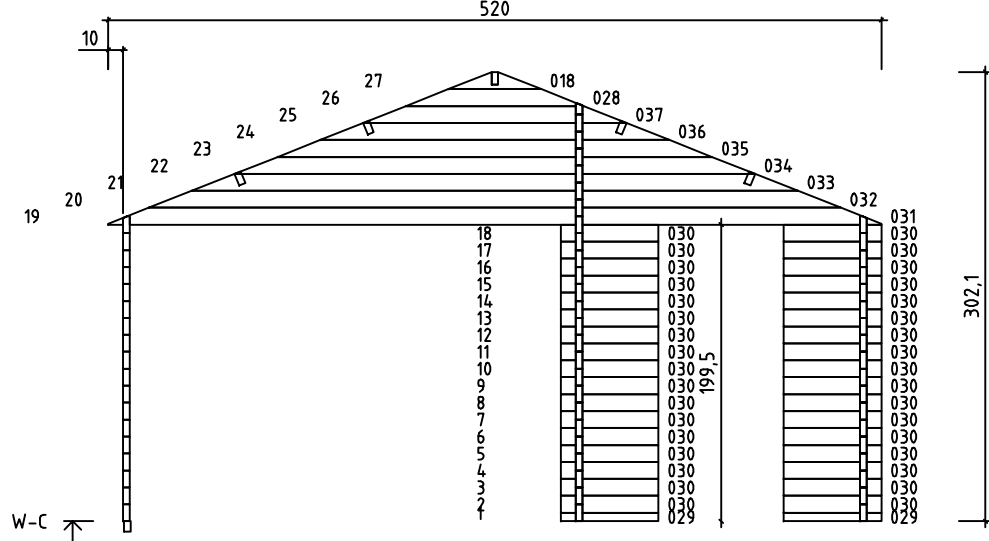
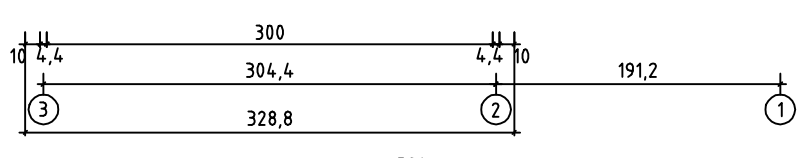
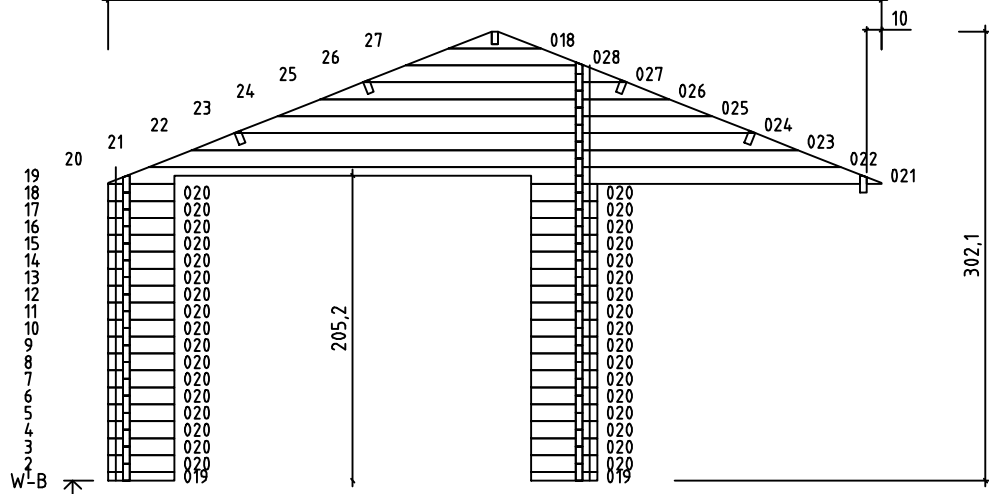
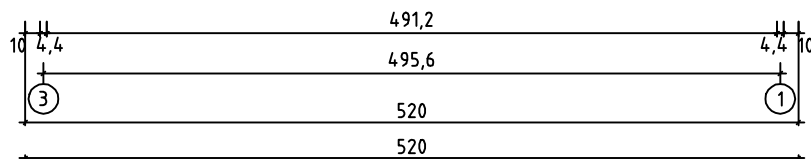
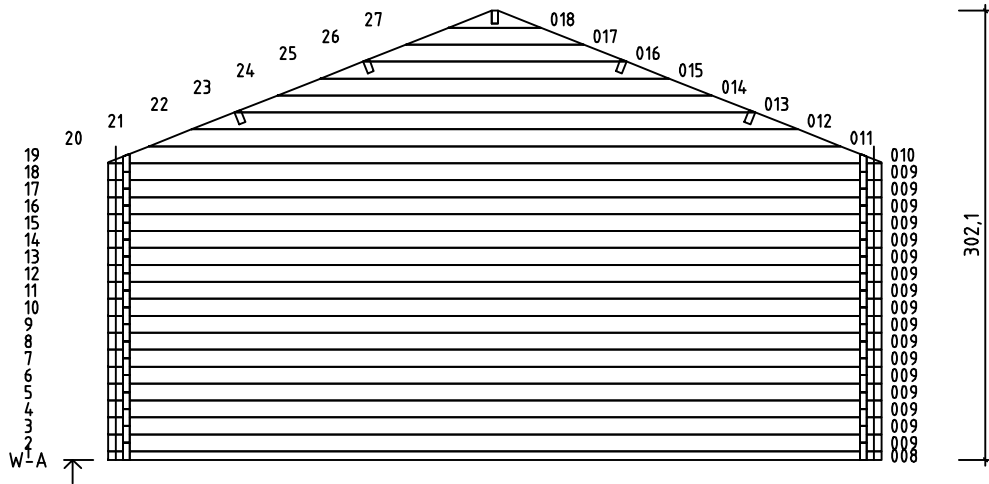



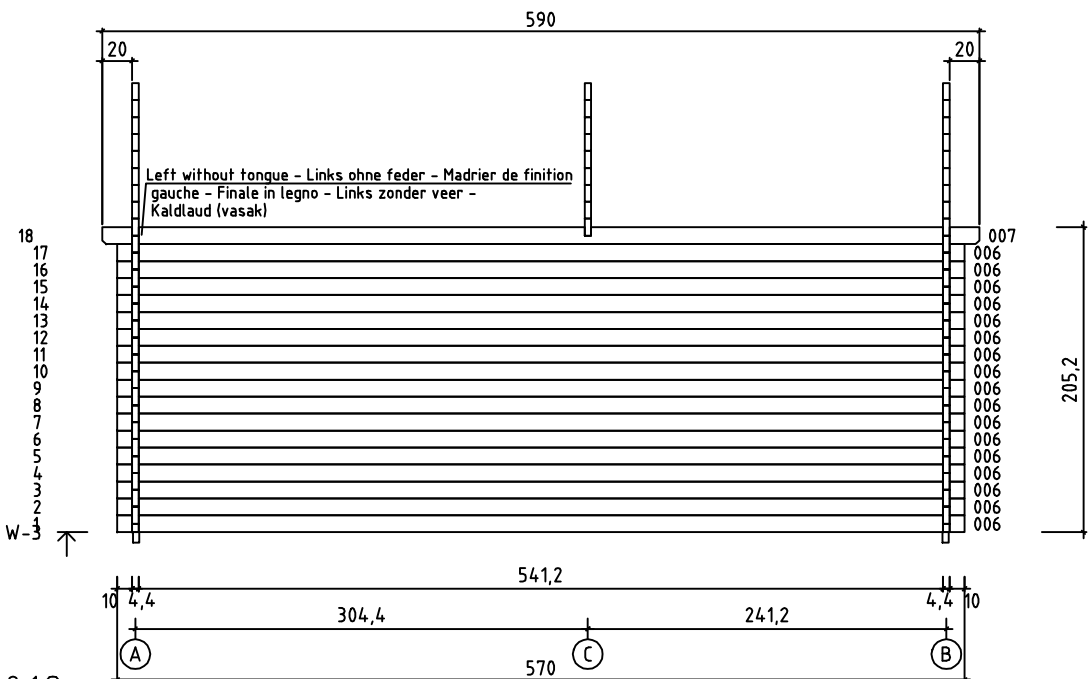
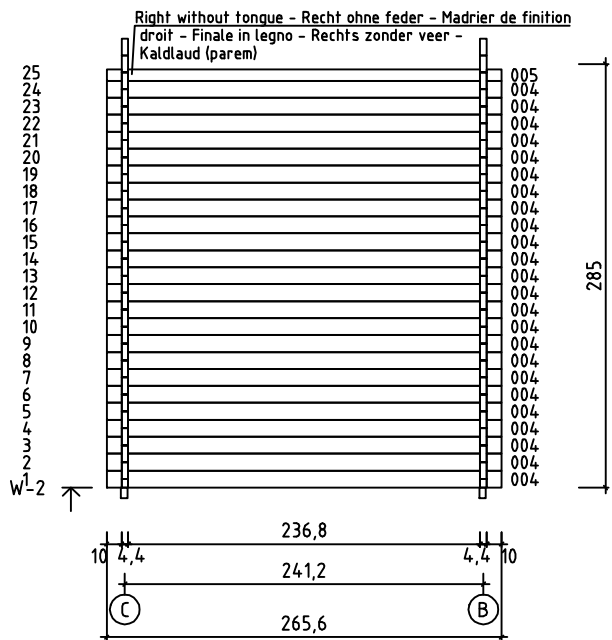
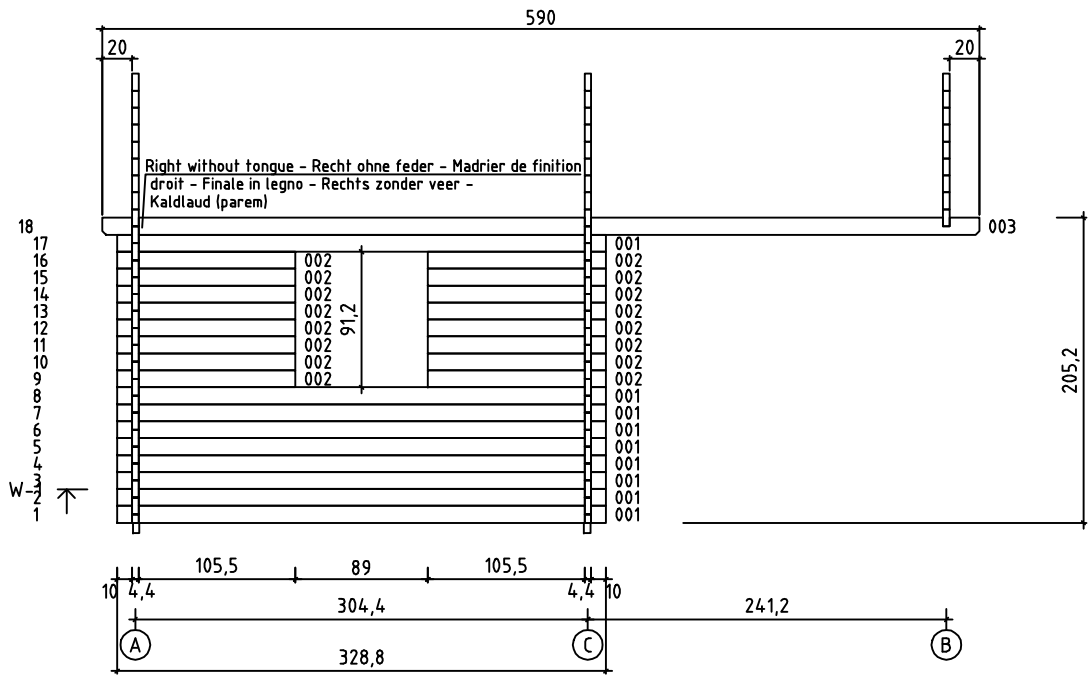

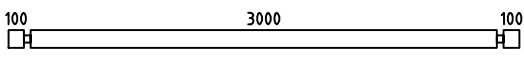
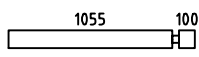
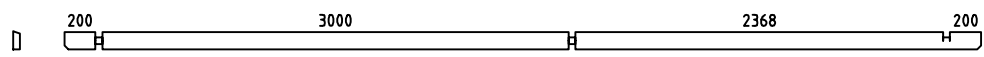
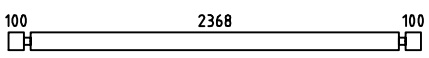
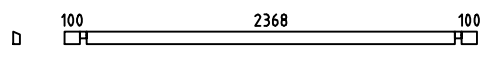
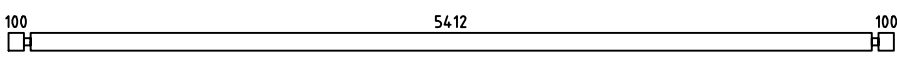
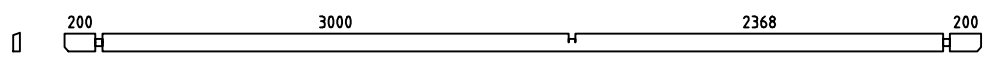
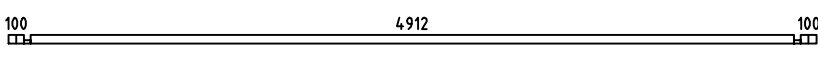
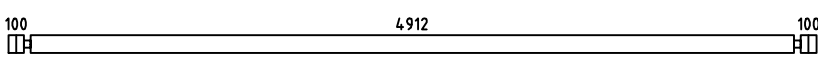

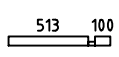
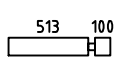
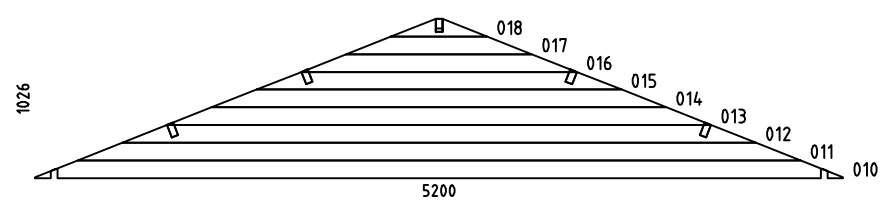
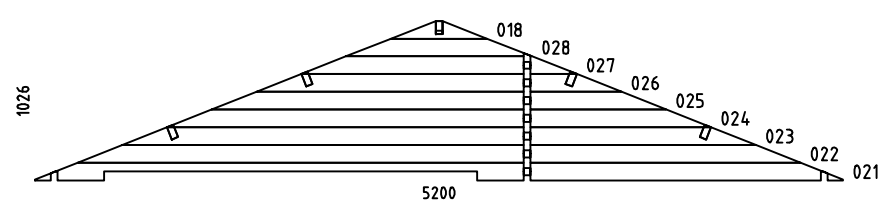
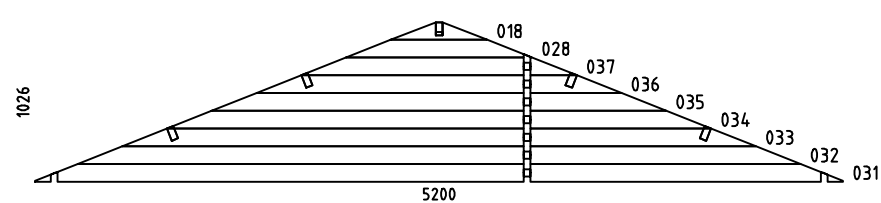
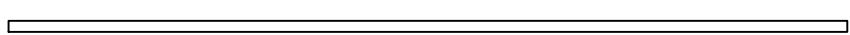

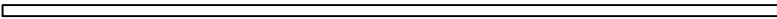
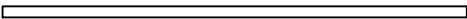
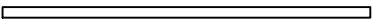
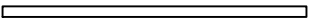

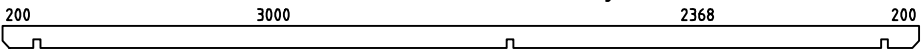

Art. Nr. 445193

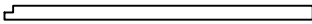
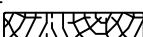

# Art. Nr. 445193

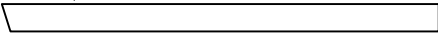

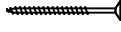
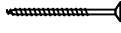
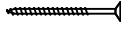
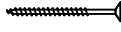
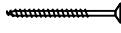
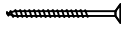

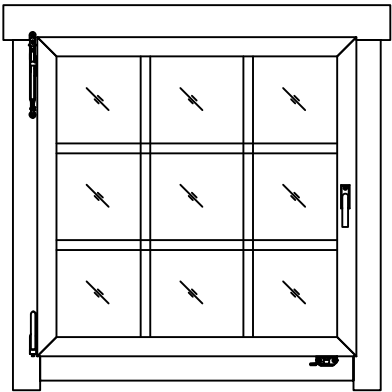
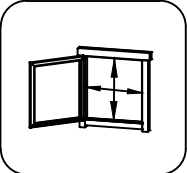
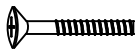
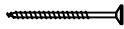

Pos	05.02.2018 Piece list - Stückliste - Liste des pièces - Elementi - Stuklijst - Tükitalabel Art. Nr. 445193 5/7	Q	P (mm)	L (mm)
001		9	44x114	3288
002		16	44x114	1199
003		1	44x120	5900
004		24	44x114	2656
005		1	44x78	2656
006		17	44x114	5700
007		1	44x120	5900
008		1	44x57	5200
009		17	44x114	5200
019		2	44x57	444
020		34	44x114	444
029		2	44x57	657
030		34	44x114	657
WA-1		1		
WB-1		1		
WC-1		1		
IAR6	Foundation - Fundament - Fondation - Fondamenta - Fundering - Immutatud alusraam 	1	45x70	5400

Pos	05.02.2018 Piece list - Stückliste - Liste des pièces - Elementi - Stuklijst - Tükitalbel Art. Nr. 445193 6/7	Q	P (mm)	L (mm)
IAR1	Foundation - Fundament - Fondation - Fondamenta - Fundering - Immutatud alusraam 	1	45x70	4990
IAR4	Foundation - Fundament - Fondation - Fondamenta - Fundering - Immutatud alusraam 	1	45x70	2988
IAR5	Foundation - Fundament - Fondation - Fondamenta - Fundering - Immutatud alusraam 	1	45x70	2367
IAR2	Foundation - Fundament - Fondation - Fondamenta - Fundering - Immutatud alusraam 	1	45x70	1957
IAR3	Foundation - Fundament - Fondation - Fondamenta - Fundering - Immutatud alusraam 	2	45x70	389
PR21	Roof beam - Dachbalken - Panne de toit - Perlina del tetto - Gordingen / dakbalk - Pärtin 	5	44x140	5900
	Roof boards - Dachbretter - Voliges - Perlina per tetto - Dakhout - Katuselaud 	132	90x18	2900
	Roofing felt fillet - Dachpappenleiste - Baguette de fixation du feutre bitumeux - Asse per fissaggio guaina bituminosa - Afdeklijst asfaltpapier - Katusepapiilist 	4	18x58	2950
	Treaded rod m10 - Gewindestange m10 - Tige filetée m10 - Barra filettata passo m10 - Draadstang 10m - Keermelatt 	3		50
	Treaded rod m10 - Gewindestange m10 - Tige filetée m10 - Barra filettata passo m10 - Draadstang 10m - Keermelatt 	1		800
	Treaded rod m10 - Gewindestange m10 - Tige filetée m10 - Barra filettata passo m10 - Draadstang 10m - Keermelatt 	4		2000
	Post - Pfosten - Poteau - Piede registrabile - Stijl - Post 	1	90x90	1915
TB-1	Fascia board - Traufbrett - Bandeau de toit - Finitura lati tetto - Gevellijst - Räästalaud 	4	18x90	2950
DRV-1	Roof edge reinforcement - Dachrandverstärkung - Corniere de renfort de bord de toit - Rinforzo x tetto - Dakrand versterking - Räästatugevdus 	4	28x34	2950
	Gable moulding - Giebelleiste - Planche de rive - Finitura per frontale e retro del tetto - Gevellijst - Viilulaud 	4	18x120	2950
	Lengthening bolt for treaded rod - Verlängerungsmutter für gewindestange - Manchon de raccordement de tige filetée - Bullone per barra filettata passo - Extensie moer voor draadstang - Keermelati jätkumutter 	4	D10	
HS8	Screw for gable segment - Schrauben für deckblatt - Vis pour fixation losange de finition - Viti x frontali tetto - Schroef voor gevelpunt segment - Krugi rombile 	4	3.5x35	
HS9	Screw for gable moulding - Schrauben für giebelleiste - Vis pour fixation planche de rive - Vite per fissare finiture davanti e dietro del tetto - Schroef voor gevellijst - Krugi viilulauale 	32	3.5x50	
HS14	Screw for post - Schrauben für pfosten - Vis de fixation des poteaux - Viti per inviare - Schroef voor stijlen - Krugi postile 	2	4.5x80	
HS12	Screw for fascia boards - Schrauben für traufbretter - Vis pour fixation bandeau de toit - Viti x striscia del tetto - Schroef voor gevellijst - Krugi räästalauale 	28	4x40	
HS12	Screw for roof edge reinforcement - Schrauben für dachrandverstärkung - Vis pour fixation corniere renfort de bord de toit - Viti x rinforzo bordo tetto - Schroef voor dakrand versterking - Krugi räästatugevdusele 	28	4x40	
HS18	Screw for roof beams - Schrauben für dachbalken - Vis pour fixation pannes de toit - Viti per perline del tetto - Schroef voor gordingen / dakbalken - Krugi pärlinitele 	21	5x120	
HS18	Screw for gable - Schrauben für giebel - Vis pour fixation des pignons - Viti per timpano - Schroef voor gevelpunt - Krugi viilude kinnitamiseks 	54	5x120	

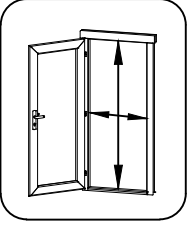
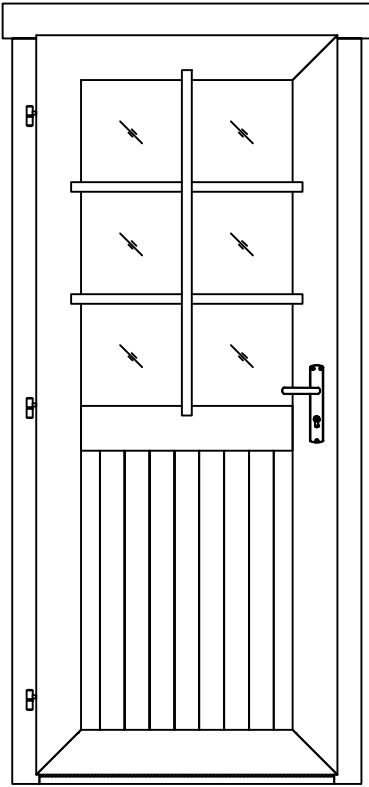

Pos	02.01.2018 Piece list - Stückliste - Liste des pièces - Elementi - Stuklijst - Tükítabel 882x882 AK.1.109.TSSV.b SGC	1/1	Q	P (mm)	L (mm)
	<p data-bbox="263 152 1284 183">Glass size - Glasgröße - Taille de la vitre - Misura del vetro - Glas afmeting - Klaasi mõõt: 738x738 mm</p> <div data-bbox="657 241 1050 631" style="text-align: center;">  </div> <div data-bbox="1337 152 1524 331" style="text-align: center;">  <p data-bbox="1369 347 1492 376">782x782 mm</p> </div>				
FS1	Window handle fittings - Fenstergriff - Poignée de fenetre - Maniglia c/ferramenta - Raamhendel -/grendel -/klink - Aknalink		1		
FSP	Bolt for window handle fittings - Bolzen für fenstergriff beschlag - Vis pour fixation poignée de fenetre - Bullone x apertura manuale finestra - Schroef voor raamhendel - Akna käepideme polt		2		
HS1	Screw for georgian bars - Schraube für sprossen - Vis pour croisillons - Viti per unire la griglia georgiana della finestra - Schroeven voor raamverdeling - Kruvi akna petfeliistule		8	2.5x20	

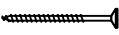
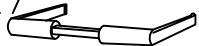

Pos	09.11.2017 Piece list - Stückliste - Liste des pièces - Elementi - Stuklijst - Tükítabel 835x1957 UK.2.056.TSVV.MM SGC	1/1	Q	P (mm)	L (mm)
Glass size - Glasgröße - Taille de la vitre - Misura del vetro - Glas afmeting - Klaasi mõõt: 561x855 mm				 735x1875 mm	
HS1	Screw for georgian bars - Schraube für sprossen - Vis pour croisillons - Viti per unire la griglia georgiana della finestra - Schroeven voor raamverdeling - Kruvi ukse petteliistule		6	2.5x20	
HS16	Screw for door jamb - Schraube für Türrahmen - Vis de fixation partie haute avec montants du cadre de porte - Viti x fissaggio montanti porte - Schroef voor deurkozijn - Kruvi ukse lengile		4	5x90	
HS25	Screw for doorstep - Schrauben für swelle - Vis pour fixation barre de seuil - Vite per soglia della porta - Schroef voor deurdorpel - Kruvi lävepakule		2	4.5x65	
TL4	Door handle fittings - Türgriff - Poignée de porte - Maniglie - Deurhendel / klink - Ukse käepide VU		1		
TL5	Set of door lock covers - Schlossblenden - Set de garnitures de porte - Copertura serrature - Slot sluitplaat set - Ukse lukuplaat		1		
	Cylinder lock - Zylinderschloss - Barillet de porte - Serratura - Cylinder slot - Ukse lukusüdamik		1	30x35	
	Male bolt hinge for door - Türband - Partie male de paumelle de porte - Cerniera anube x porta - Scharnier bout - Ukse polthing isane		3		

*Garaažiuks laudisega*  
*Art. Nr. 447720*  
*1/3*



21.06.2018

Pos	21.06.2018	Piece list - Stückliste - Liste des pièces - Elementi - Stuklijst - Tükítabel Art.Nr. 447720	2/3	Q	P (mm)	L (mm)
-----	------------	---	-----	---	-----------	-----------

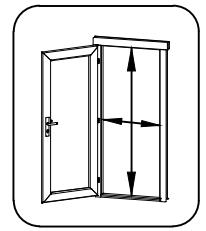

2290x1970 mm

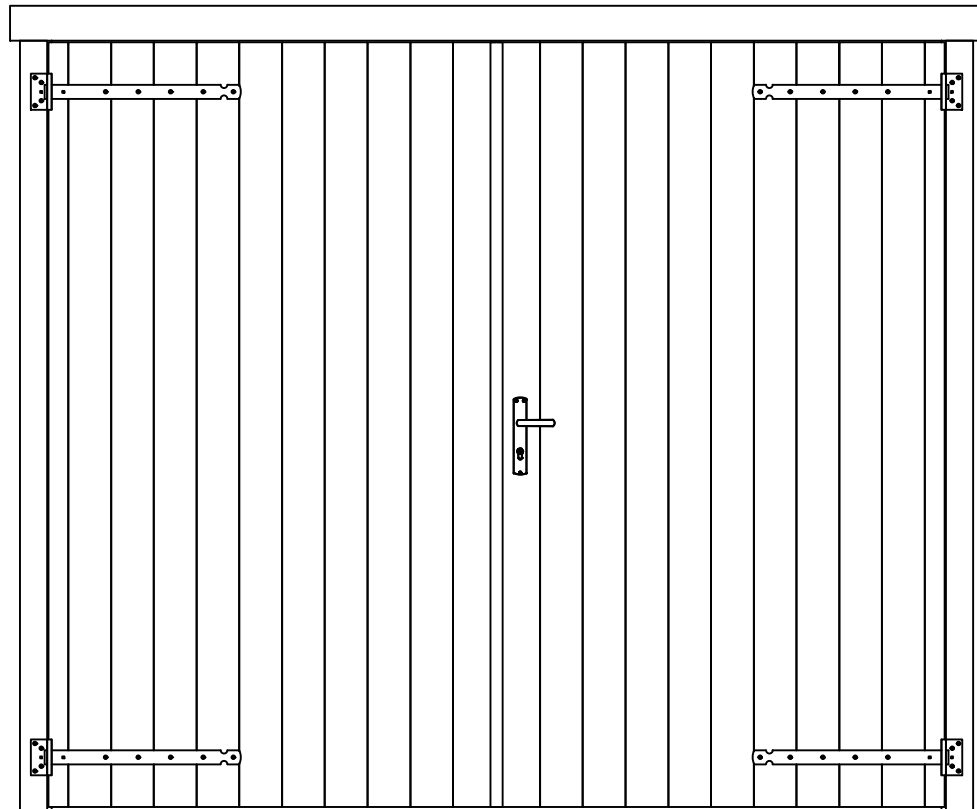

1	Upper door jamb - Türrahmen oben - Cadre de porte supérieur - Telaio superiore della porta - Bovendorpel - Ukse ülemine leng		1	82x102	2290
2	Left door jamb - Türrahmen links - Cadre de porte gauche - Telaio montante sinistro della porta - Linkerstijl deurframe - Ukse vasak leng		1	82x82	2020
3	Right door jamb - Türrahmen rechts - Cadre de porte droit - Telaio montante destro della porta - Rechterstijl deurframe - Ukse parem leng		1	82x82	2020
4	Connection strip - Deckleiste - Baguette de battement - Profilo verticale della porta - Stulplijst - kokkuvältsiliist		1	13x32	1968



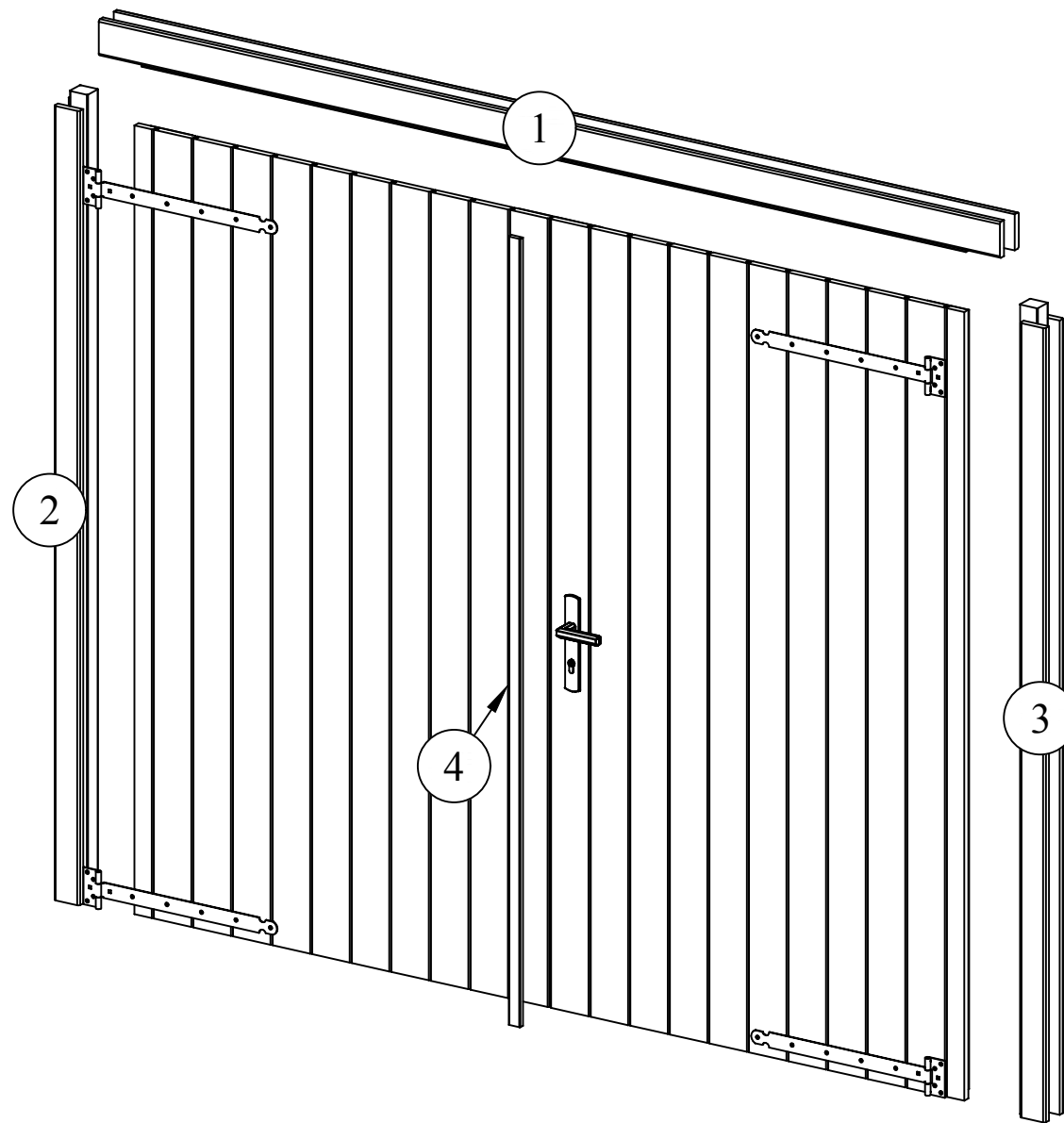

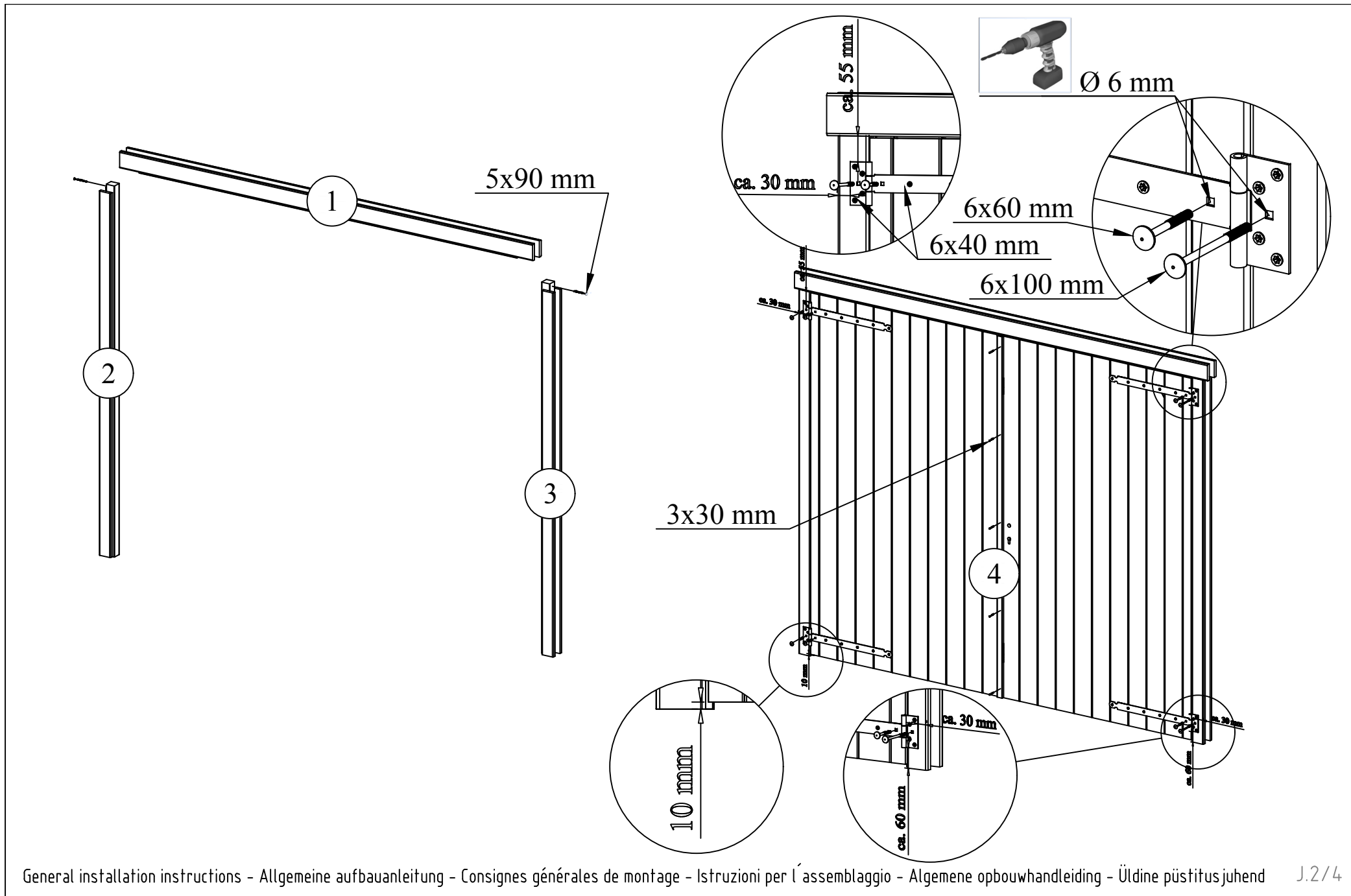

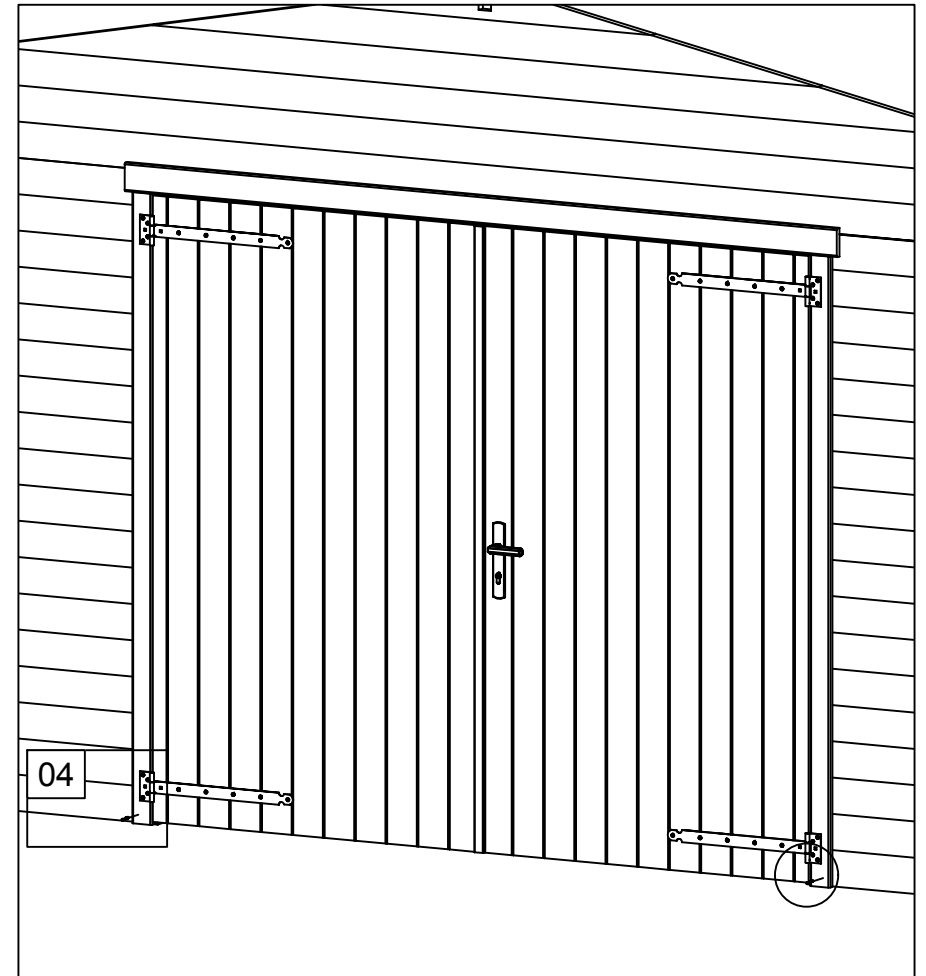
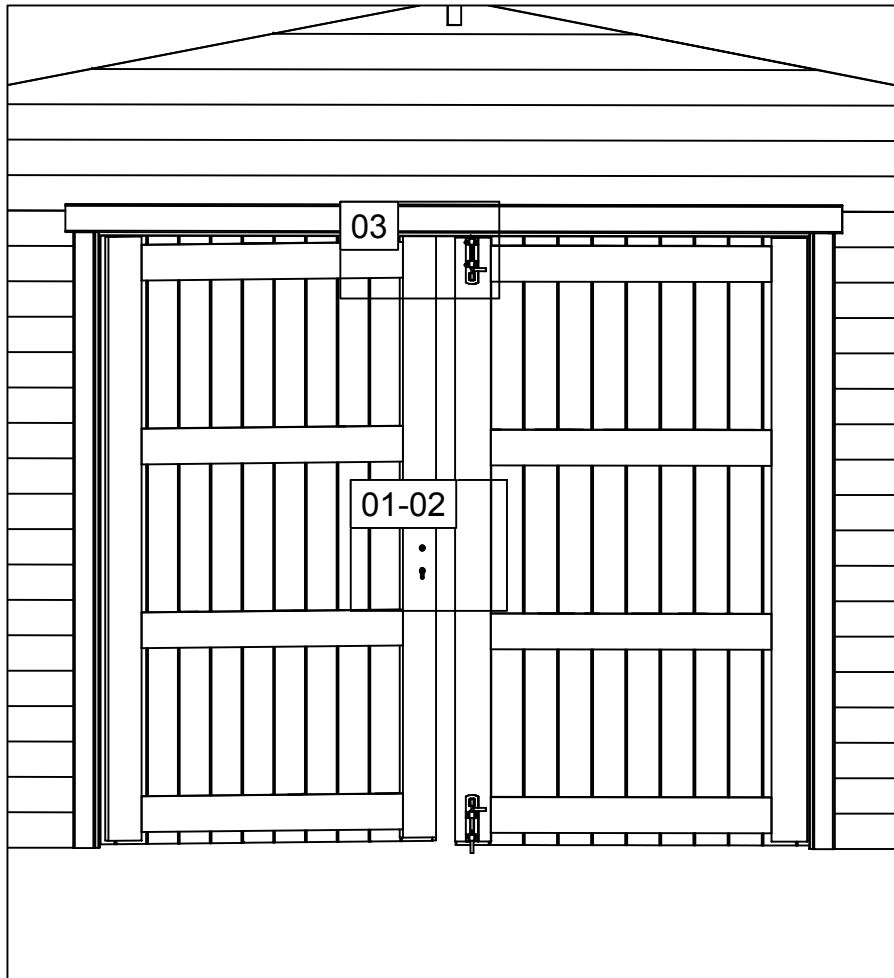

01

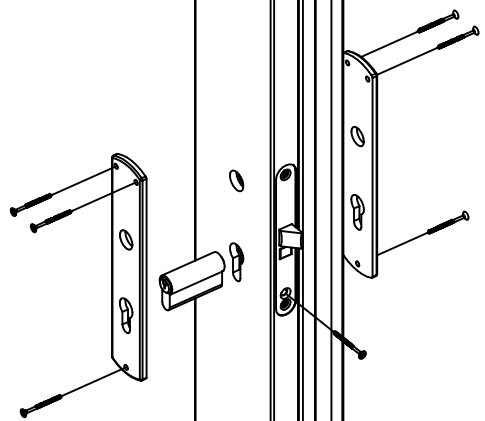

03



Ø 10 mm

4x25 mm

02

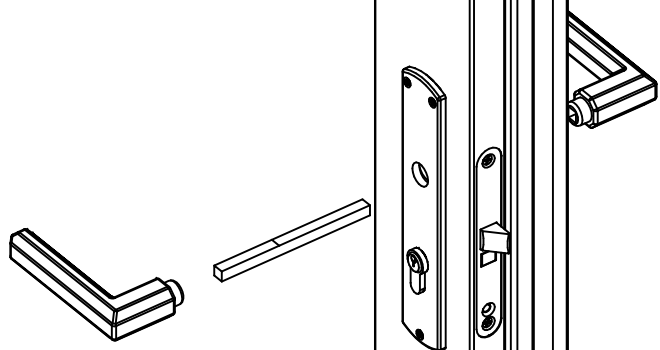

04

3.5x50 mm

