

# 60696...

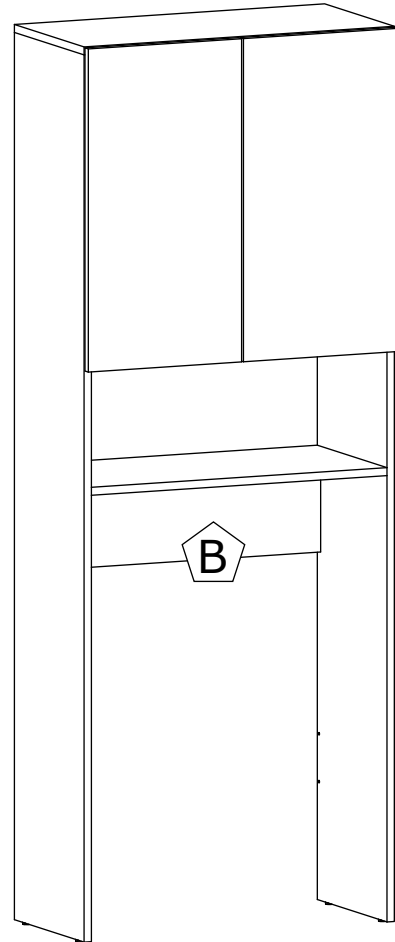
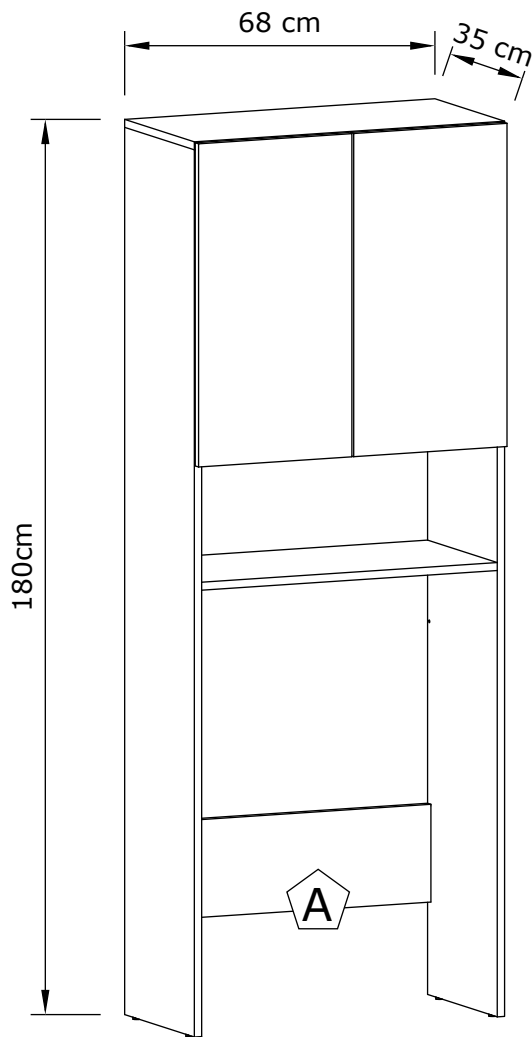
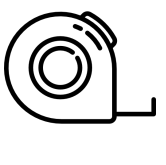
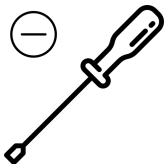
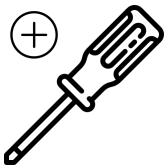
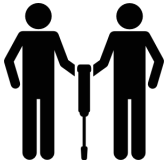
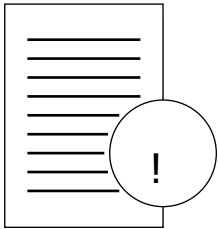

D *Montageanleitung*

NL *Handleiding voor de montage*

TR *Montaj talimat*

FR *Notice de montage*

CZ *Montážní návod*

HU *Szerelési útmutató*

GB *Assembly instructions*

PL *Instrukcja montażu*

RU *Инструкция по монтажу*

IT *Istruzioni di montaggio*

SK *Návod na montáž*

RO *Instrucțiuni de montaj*

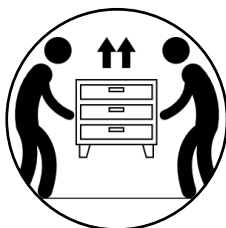



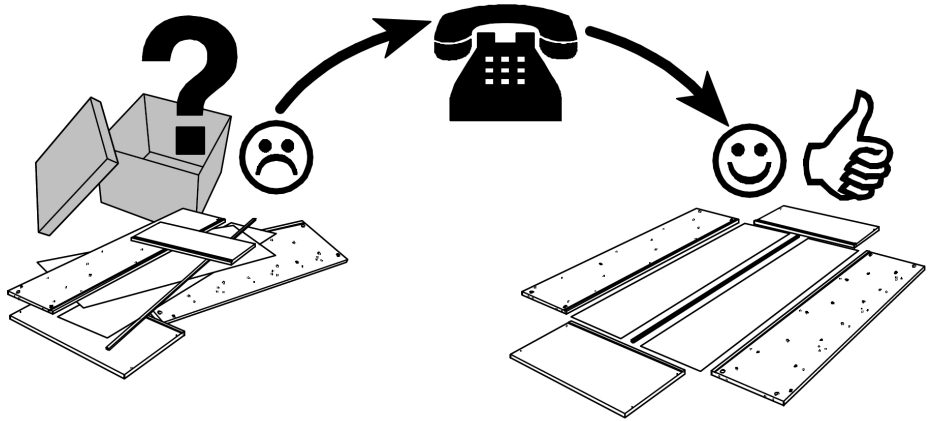
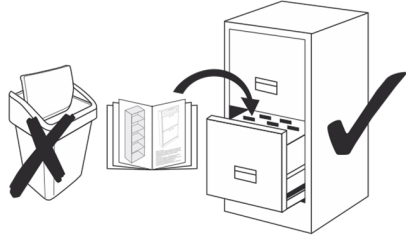

Name • Nom • Nome • Naam  
Nazwa • Jméno • Názov • Név  
Denumire • Ísim • Название

Nr. • No. • N° • Номер • Č • Sz

Typ • Type • Tip • Típus • Тип

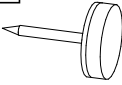
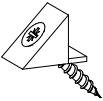
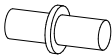
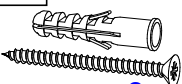

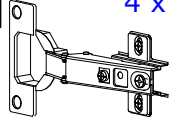
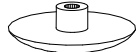
<b>A</b>	12 x	<b>M1</b>	20 x	<b>ML</b>	20 x	<b>SS</b>	4 x	<b>H</b>	6 x	<b>E</b>	4 x
											
	8 x 35										
<b>XL</b>	1 x	<b>X</b>	8 x	<b>ZN</b>	4 x	<b>MZ</b>	12 x				
											
	8 x 60		3,5 x 16								

Achtung | Attention | Attenzione | Opgelet | Uwaga | Pozor | Figyelem | Atenție |  
Dikkat | Внимание

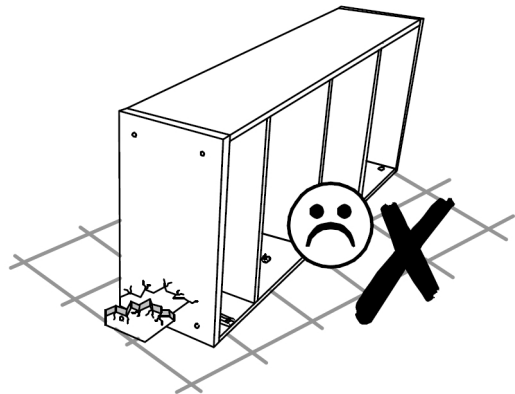
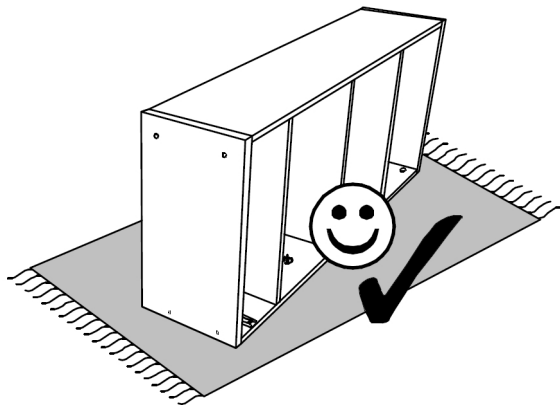



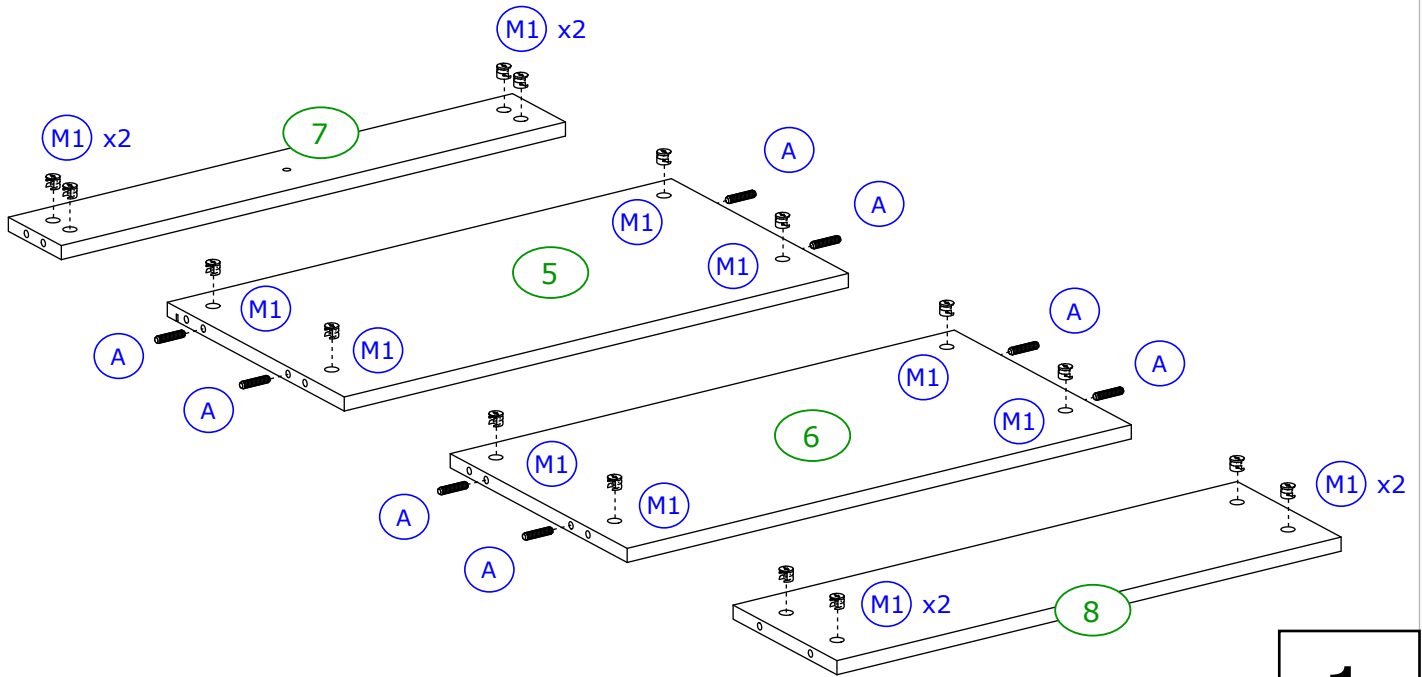
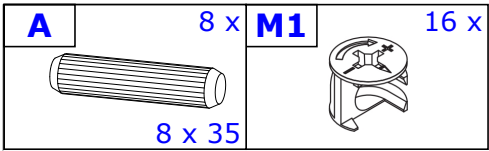

**1**

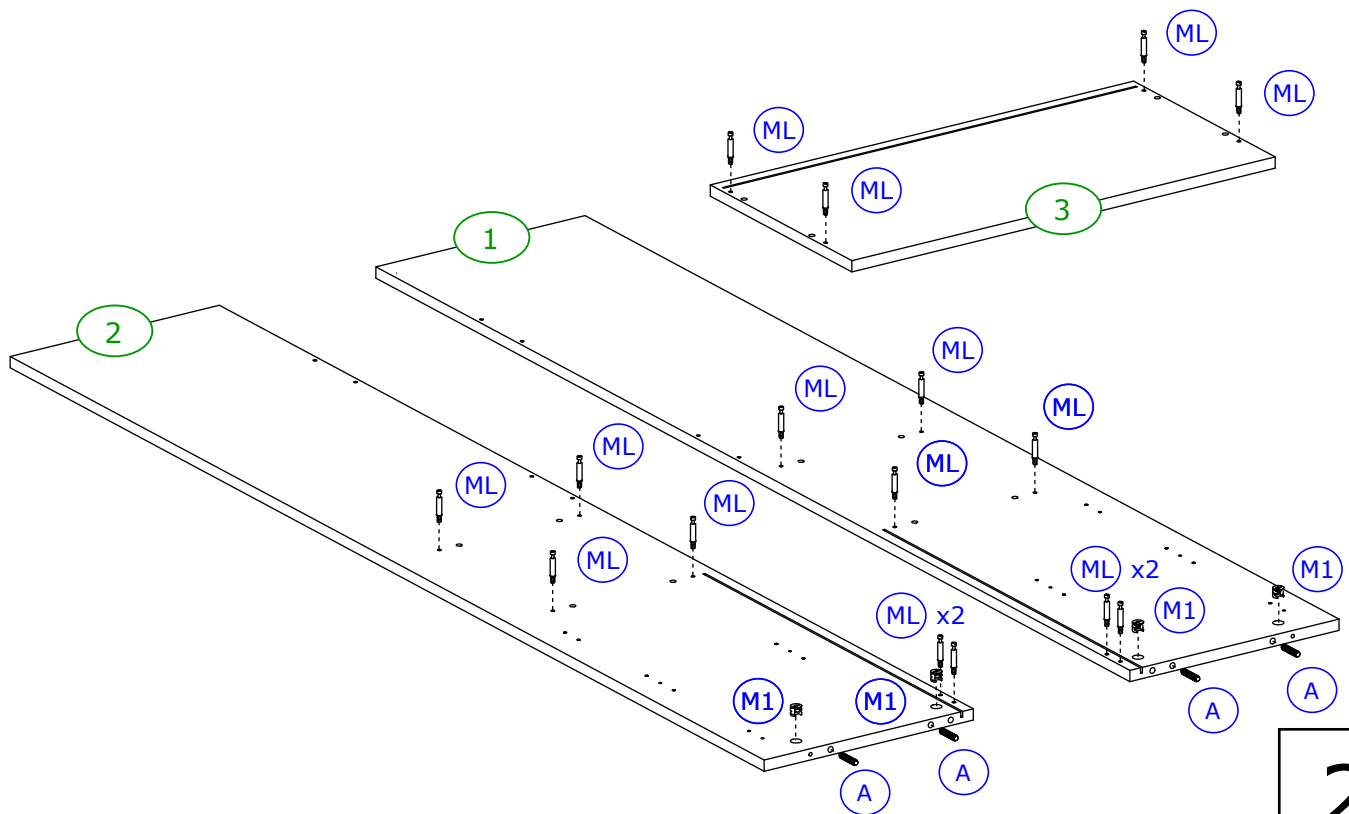
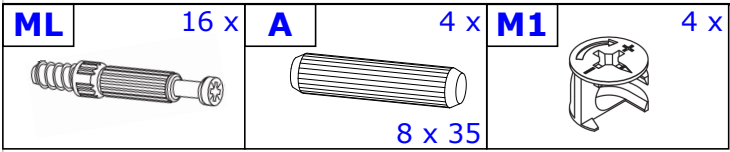

**2**

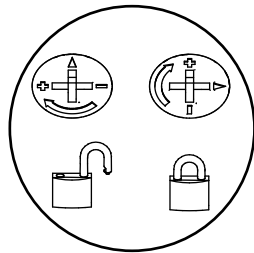
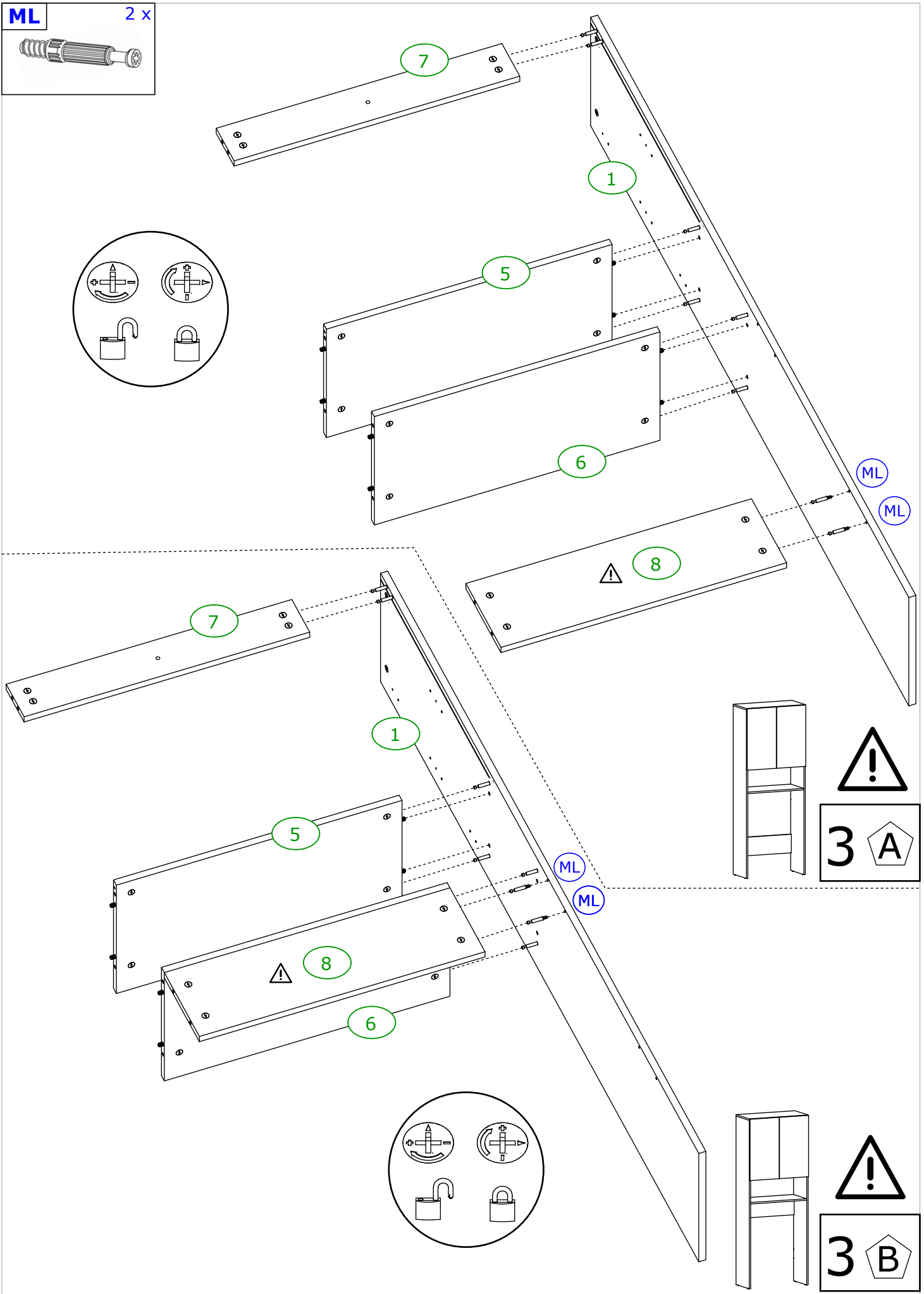
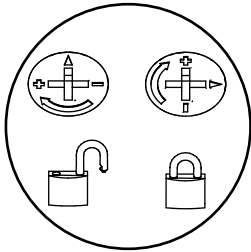
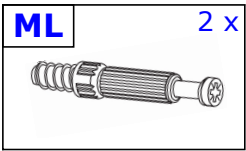

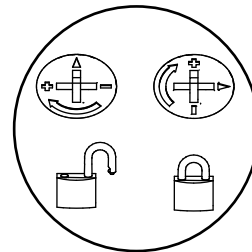
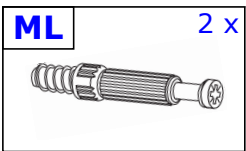

A

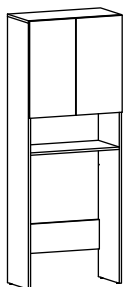

B

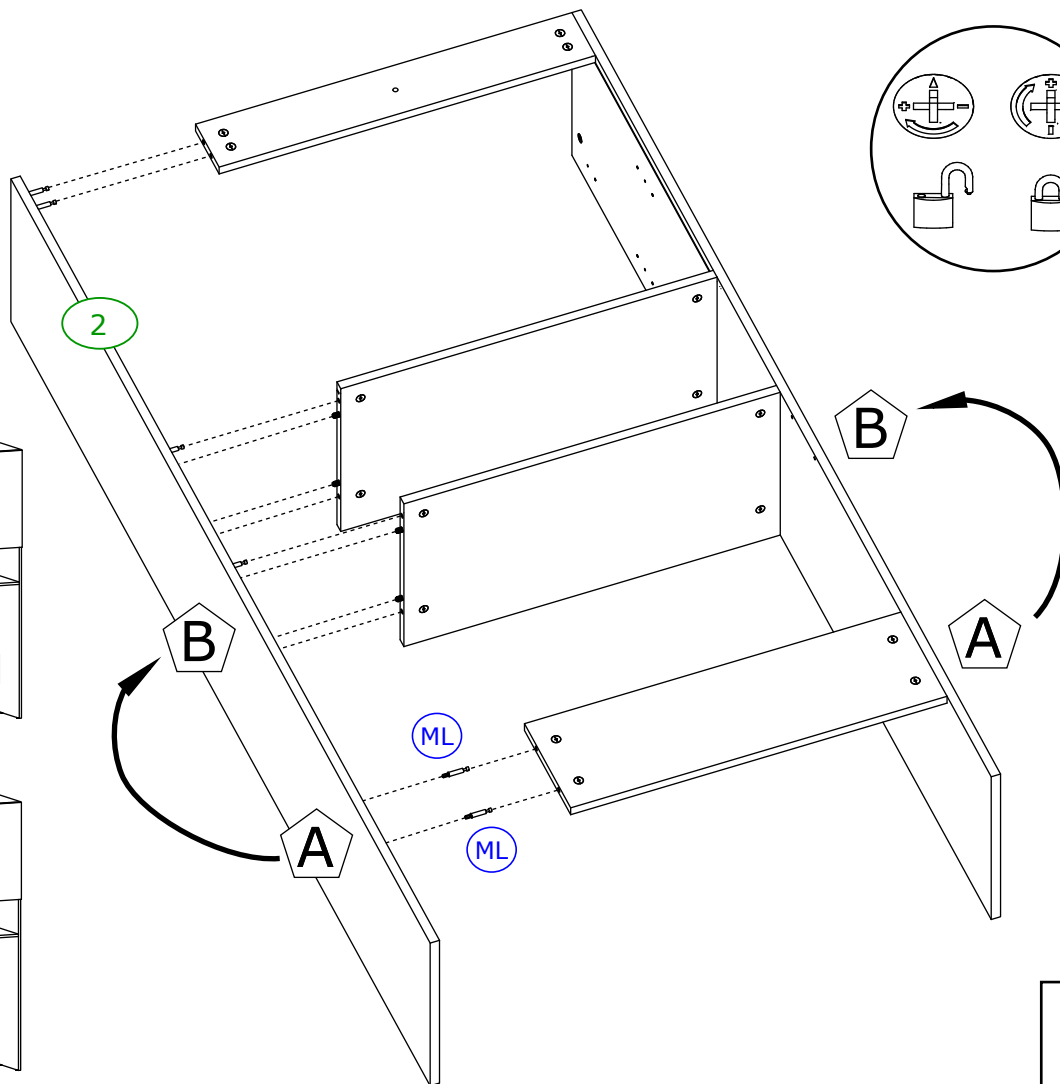
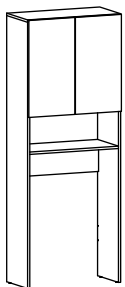

4

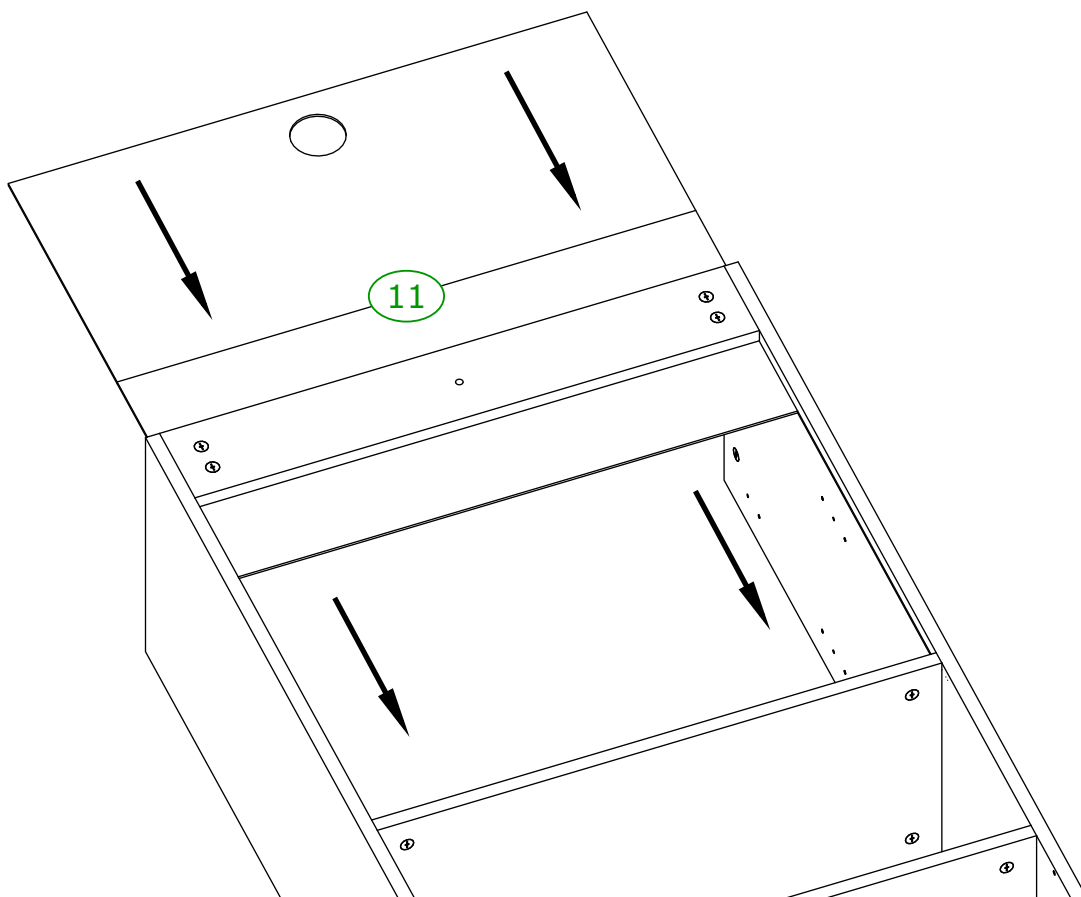

5

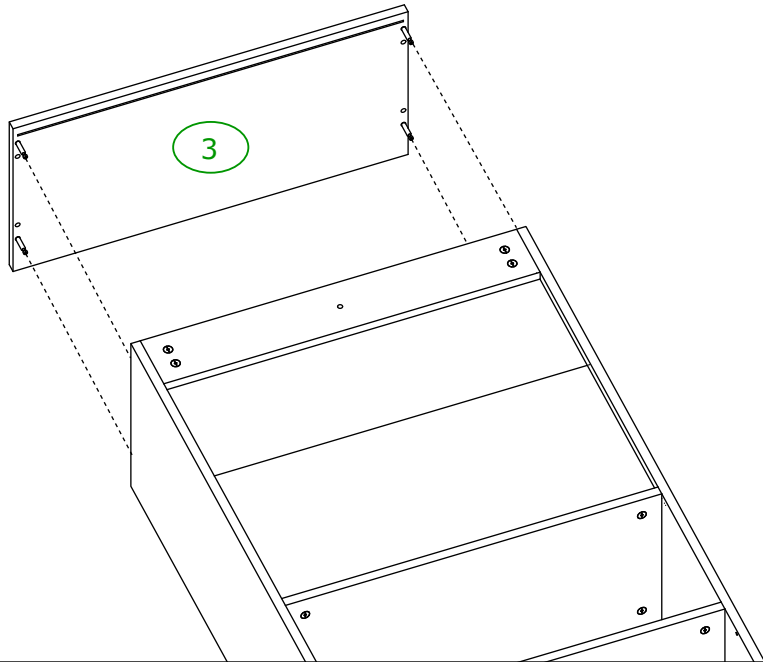
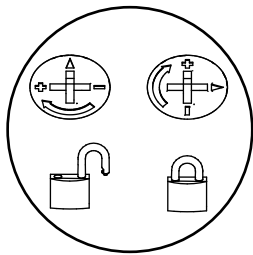

6

SS 4 x

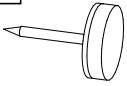

H 6 x

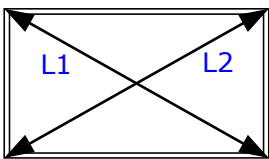
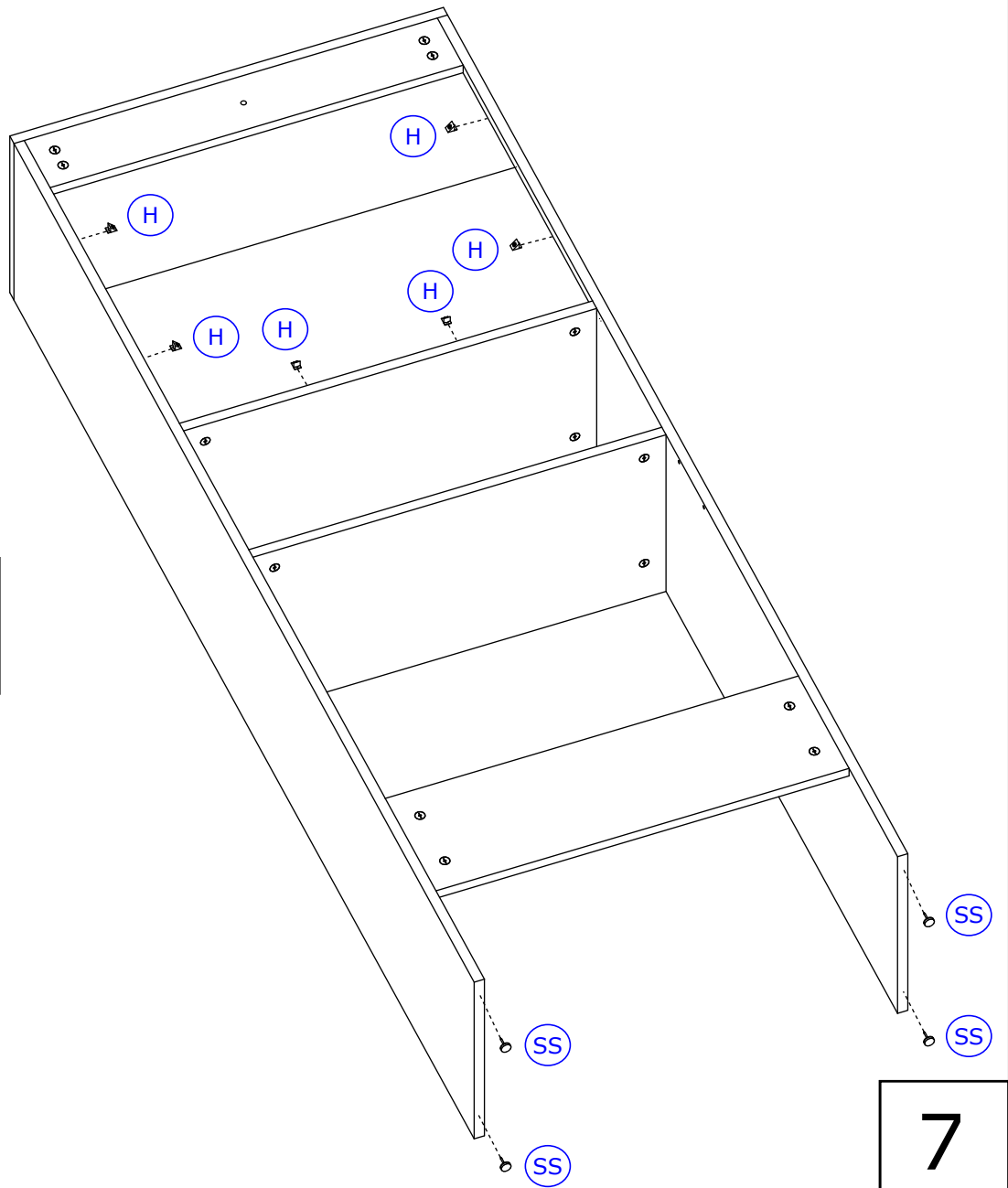
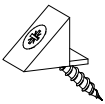

L1=L2

7

<b>(D)</b>	Wandbefestigung dient als Kippschutz – unbedingt anbringen! Bei einigen Wandtypen kann ein Spezialdübel erforderlich sein!
<b>(GB)</b>	The wall fastening serves to prevent tipping – be absolutely sure to mount it! For certain wall types, a special dowel may be necessary!
<b>(NL)</b>	Bevestiging aan de muur dient als kantelbescherming – zeker en vast bevestigen! Bij enkele muurtypen is een speciale plug misschien vereist!
<b>(PL)</b>	Mocowanie do ściany jest jednocześnie zabezpieczeniem przed przewróceniem – koniecznie zamontować! Do niektórych rodzajów ścian konieczne mogą być specjalne wkręty!
<b>(TR)</b>	Duvardaki sabitleme, devrilmeye karşı bir emniyet tedbiridir ve mutlaka monte edilmelidir! Bazı duvar tiplerinde bunun için özel bir dübel gerekli olabilir!
<b>(RU)</b>	Обязательно установите крепление на стене во избежание опрокидывания! Для некоторых типов стен может потребоваться специальный дюбель!
<b>(FR)</b>	La fixation murale sert de protection contre le basculement – à installer impérativement ! Pour certains types de murs il faut des chevilles spéciales !
<b>(IT)</b>	Il fissaggio alla parete serve da protezione anti-ribaltamento – attaccarla assolutamente! Per alcune strutture di parete può essere necessario un tassello speciale!
<b>(CZ)</b>	Montáž na stěnu slouží jako ochrana proti převrnutí – bezpodmínečně umístěte! U některých typů stěn může být zapotřebí speciální hmoždinka!
<b>(SK)</b>	Upevnenie na stenu slúži ako ochrana proti prevráteniu – bezpodmienečne použite! Pre niektoré druhy stien môže byť potrebná špeciálna hmoždinka!
<b>(HU)</b>	A termékét a falhoz kel rögzíteni, különben az felborulhat! Egyes faltípusoknál speciális tiplit kell használni!
<b>(RO)</b>	Sistemul de fixare la perete servește ca protecție la răsturnarede montat obligatoriu! Pentru unele tipuri de pereți este posibil să fie necesar un diblu special!

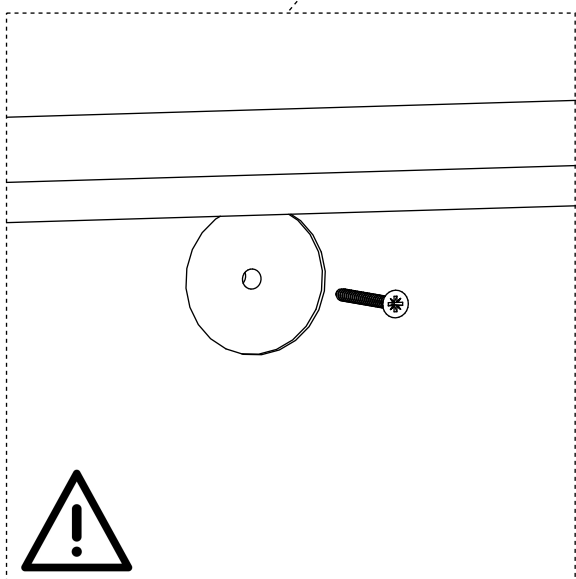
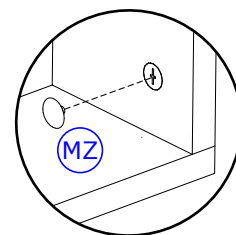
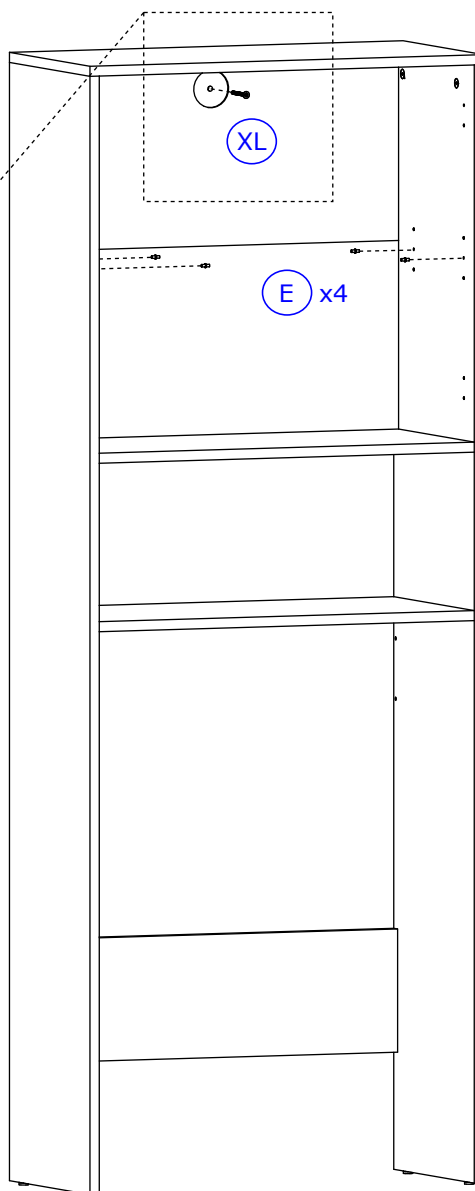
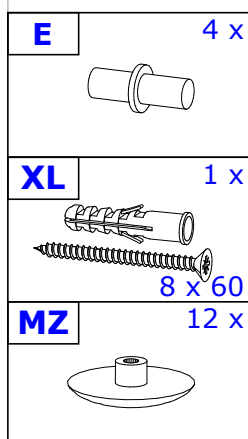



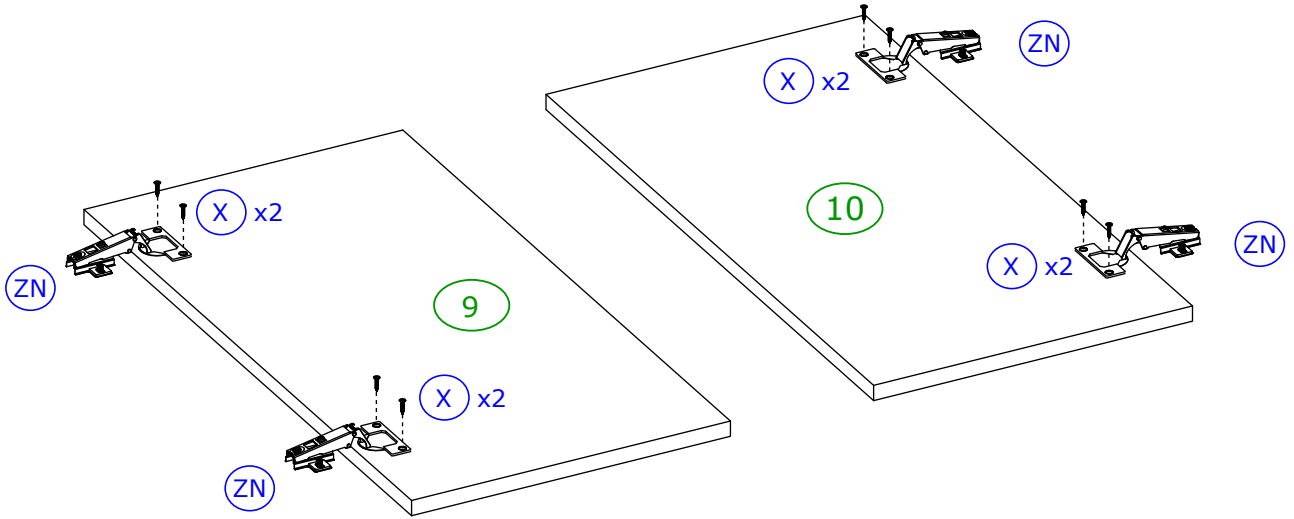
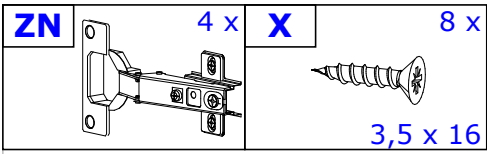

9

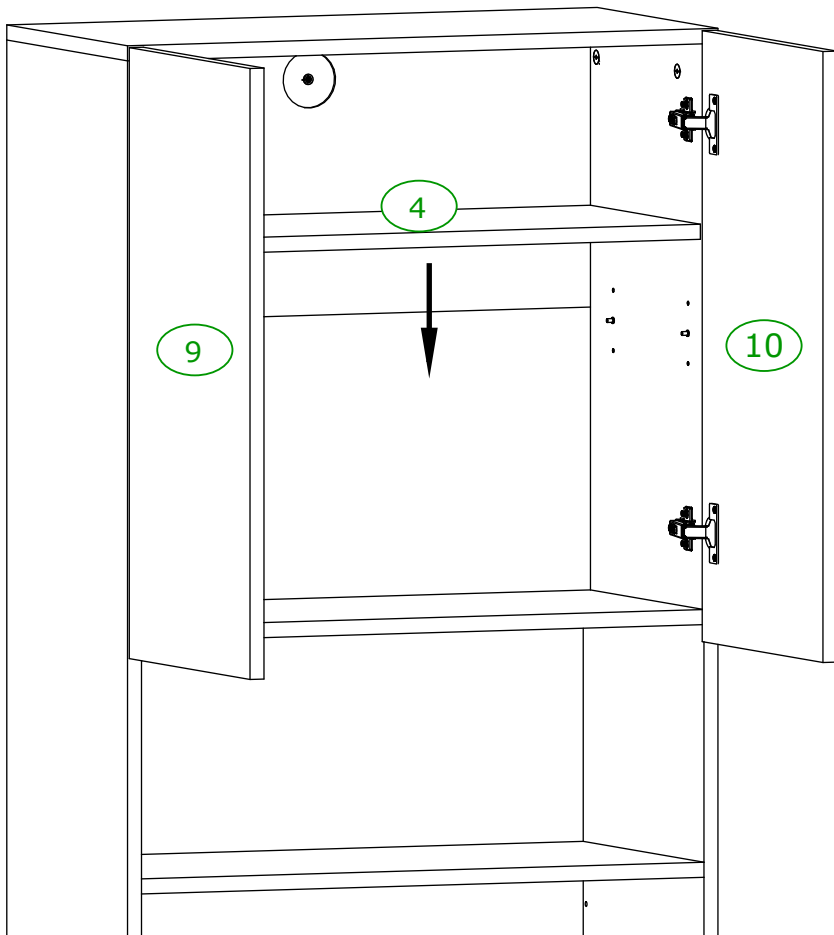

10

**D** Türen einstellen  
(Scharniere justieren)

**NL** Deuren instellen  
(scharnieren afstellen)

**TR** Kap. lar. n ayarlanmas.  
(menteşelerin seviye ayar.)

**FR** Régler les portes  
(ajuster les charnières)

**CZ** Vyrovnajte dvířka  
(seřídte závěsy)

**HU** Állítsa be az ajtókat  
(állítsa be a zsanérokat)

**GB** Adjusting the doors  
(adjusting the hinges)

**PL** Nastawić drzwi  
(wyrównać zawiasy)

**RU** Регулировка дверей  
(регулировка шарнира)

**IT** Sistemare le porte  
(regolare le cerniere)

**SK** Nastavenie dverí  
(nastavenie závesov)

**RO** Reglare ușii  
(ajustare balamale)

