

INDEX 19

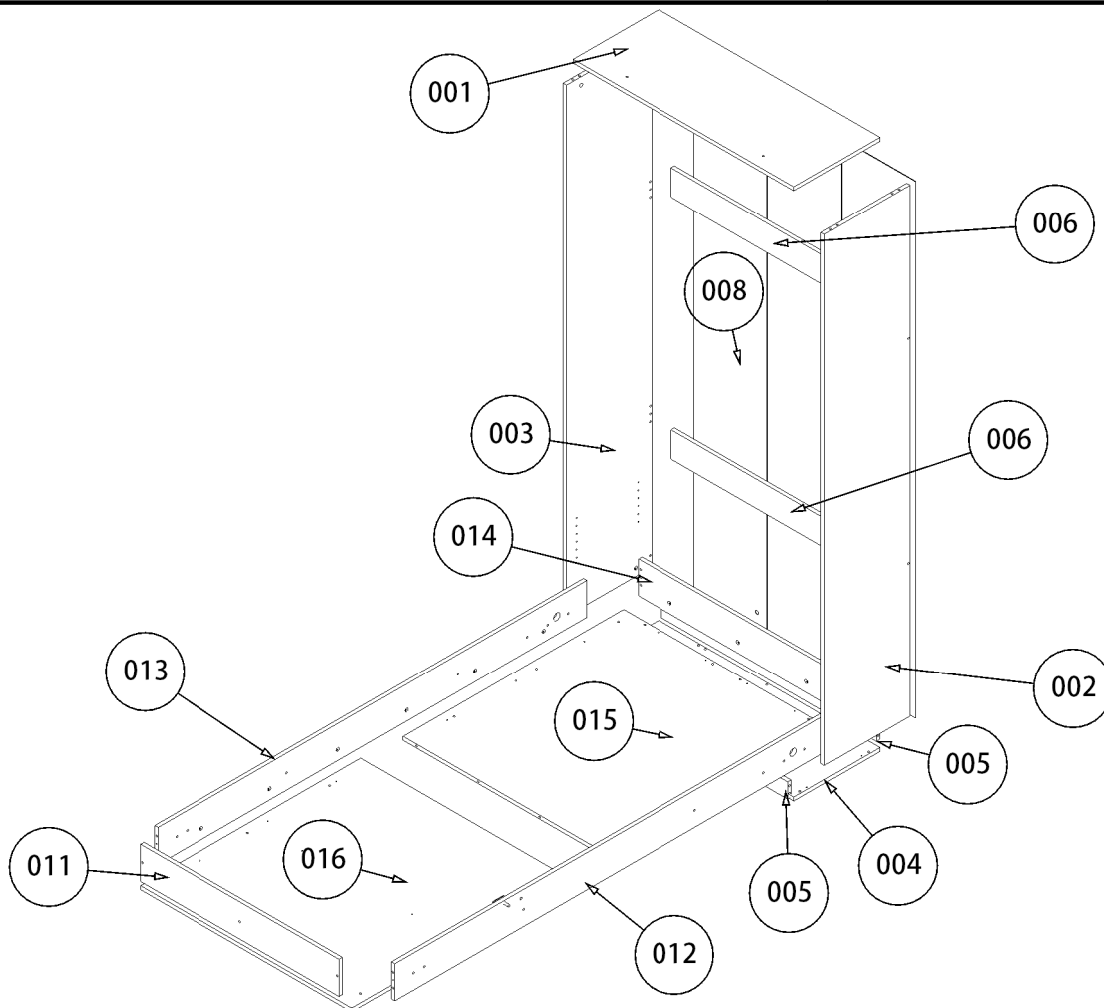

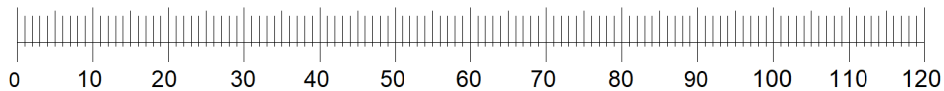

01

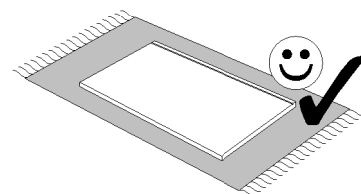
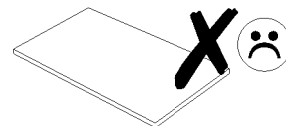
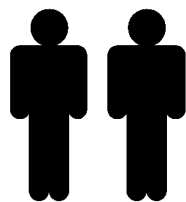
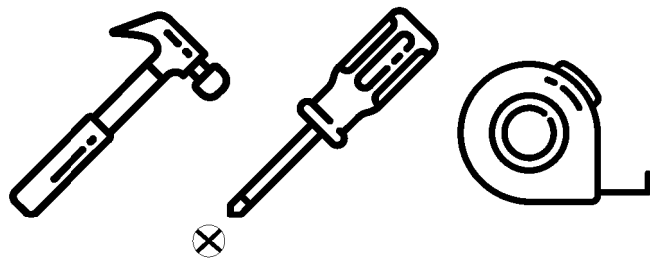
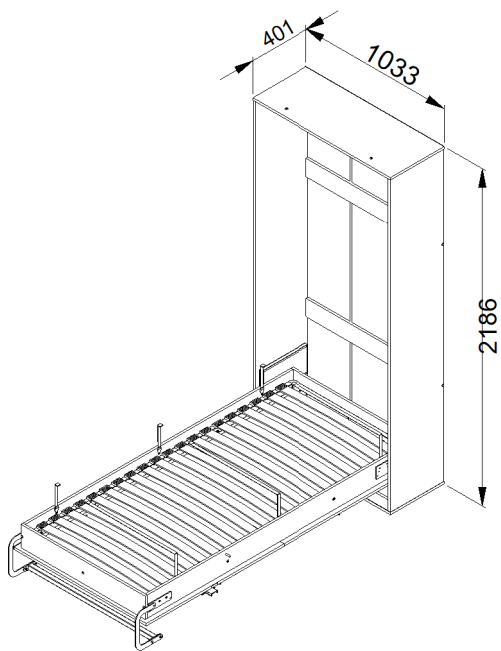
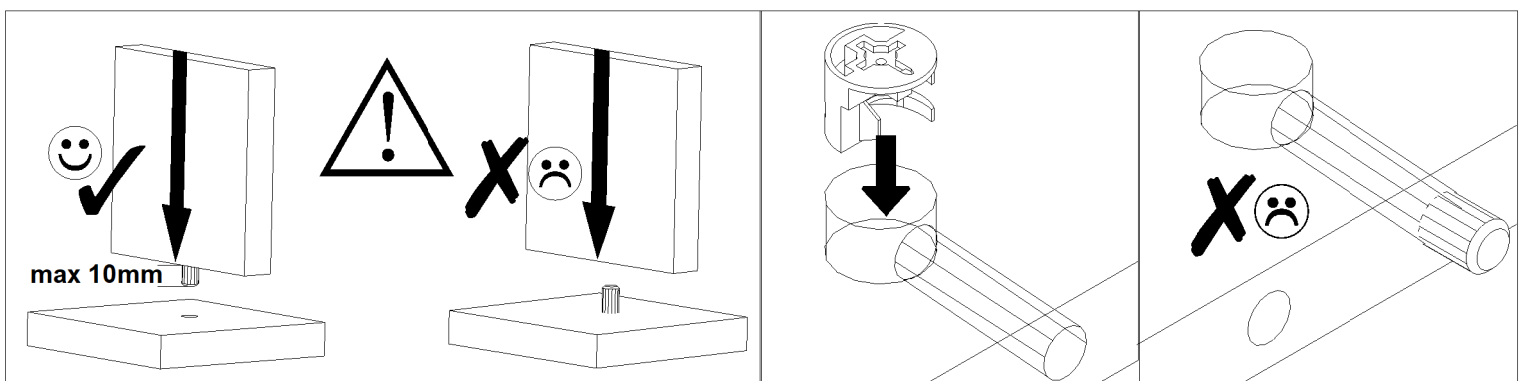
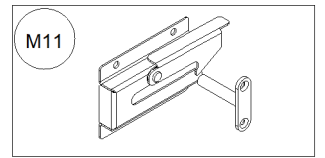
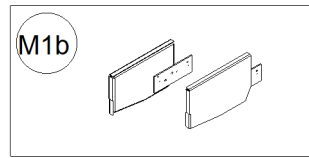
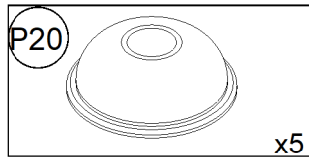
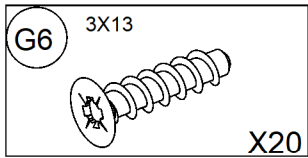
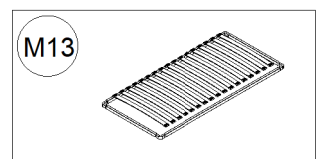
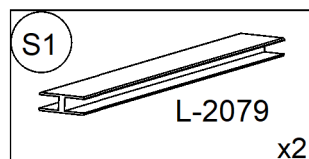
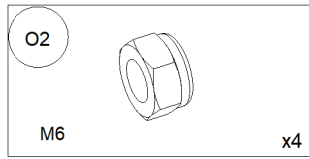
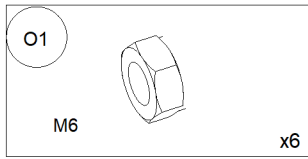
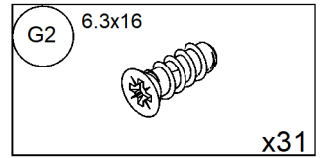
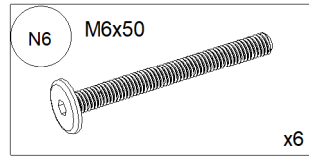
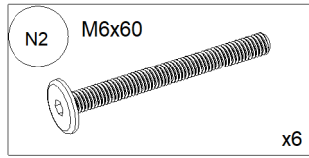
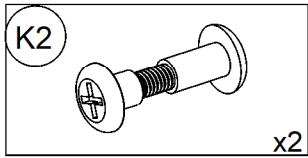
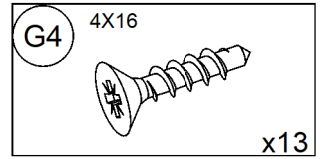
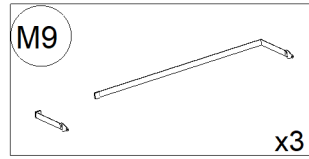
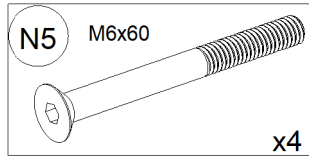
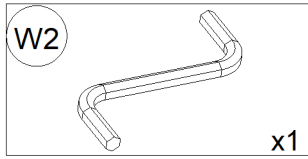
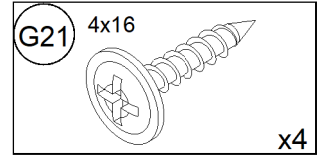
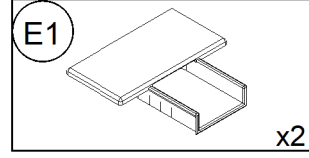
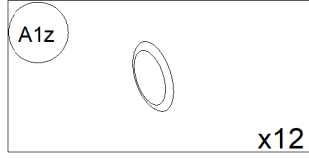
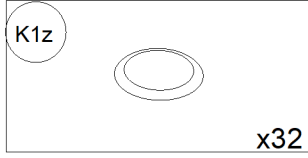
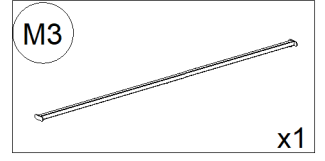
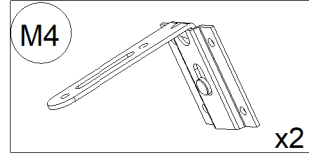
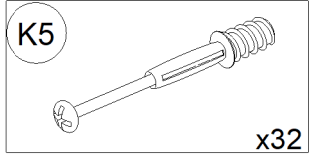
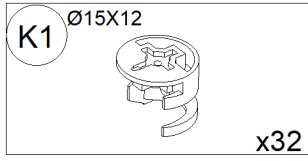
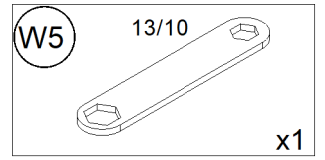
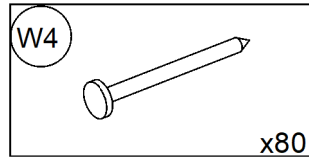
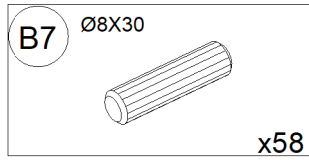
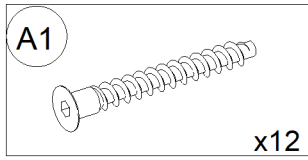
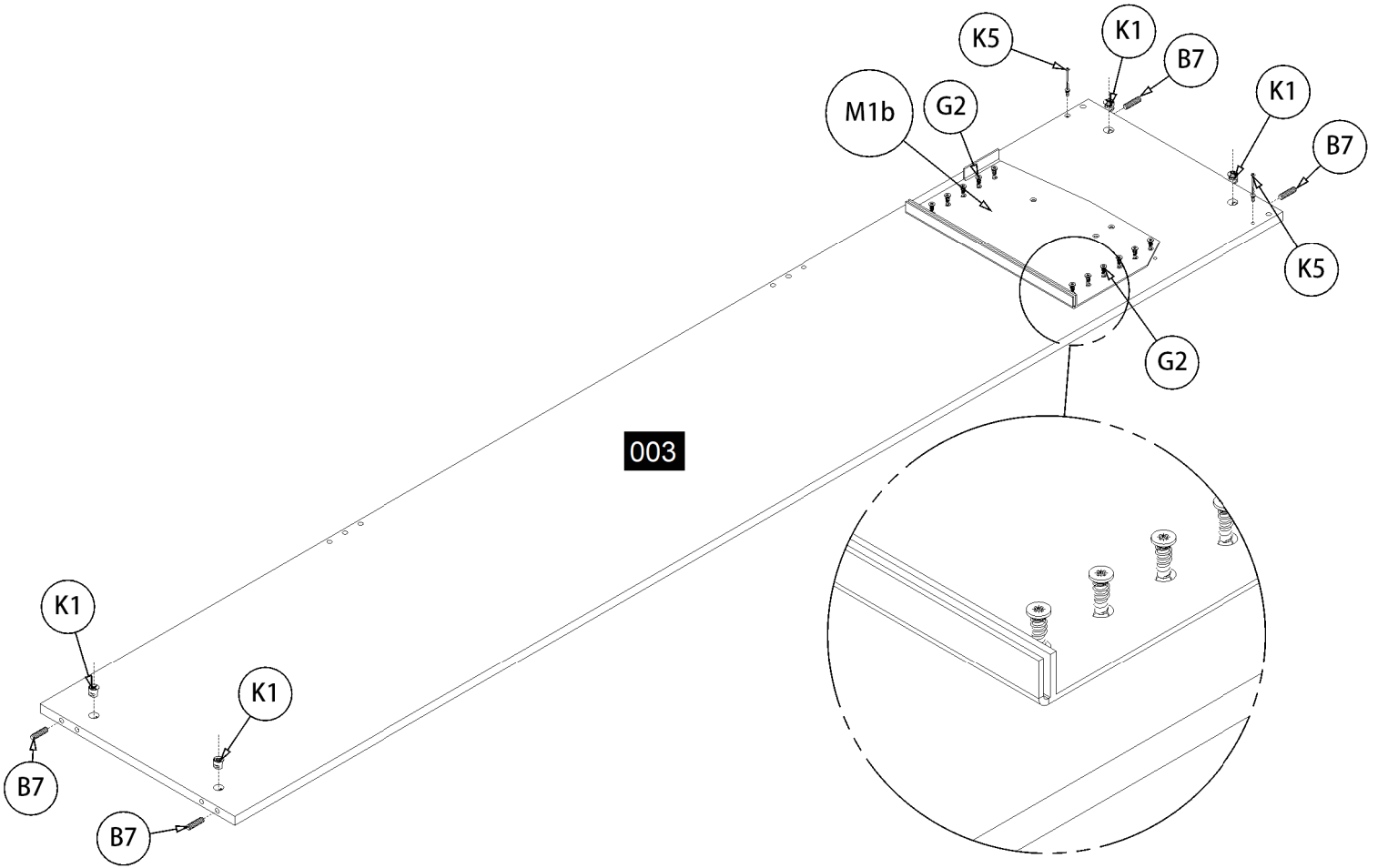
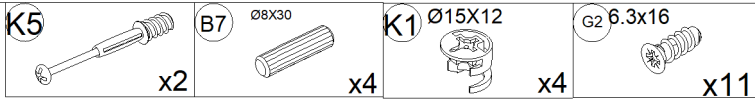

02

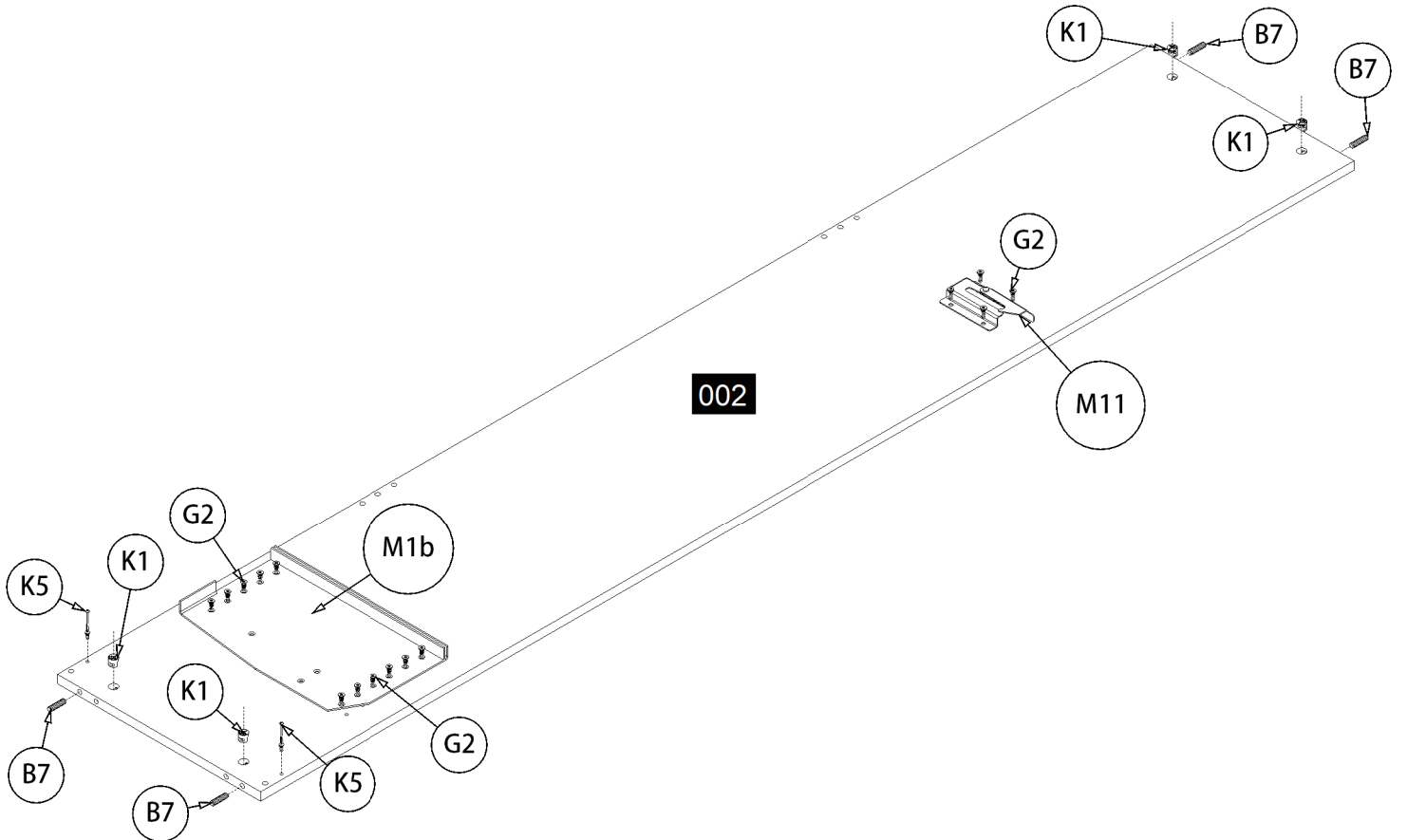
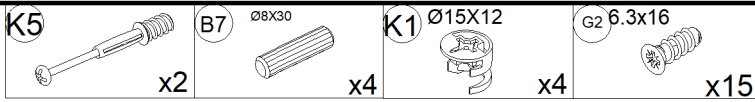

03

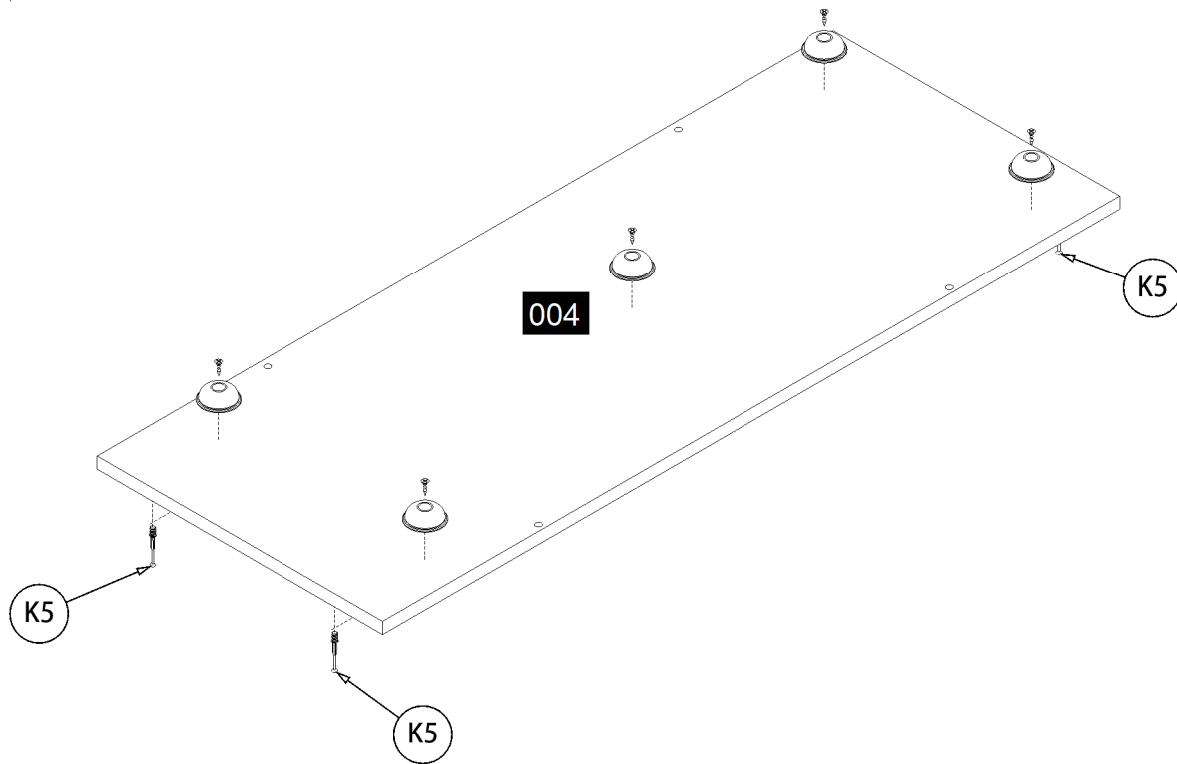
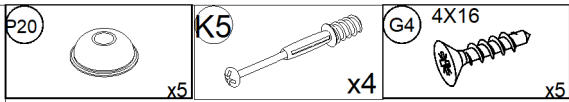

04

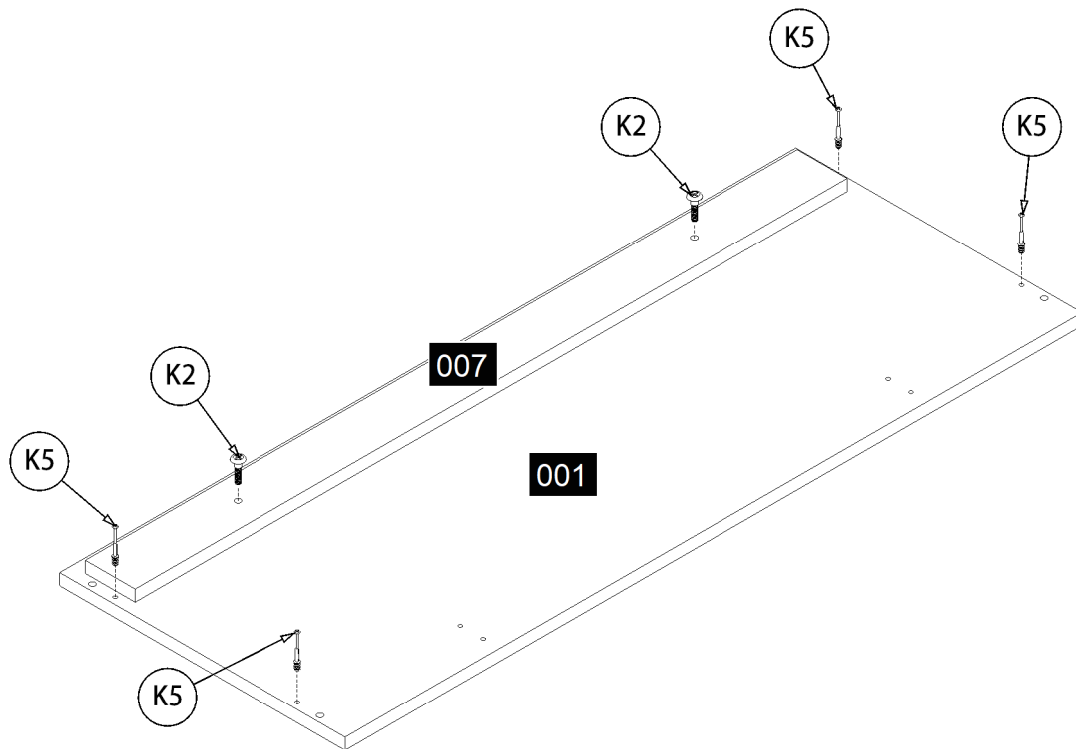
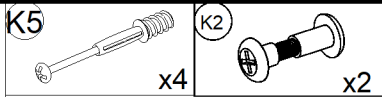

05

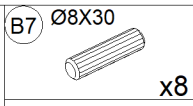

x2

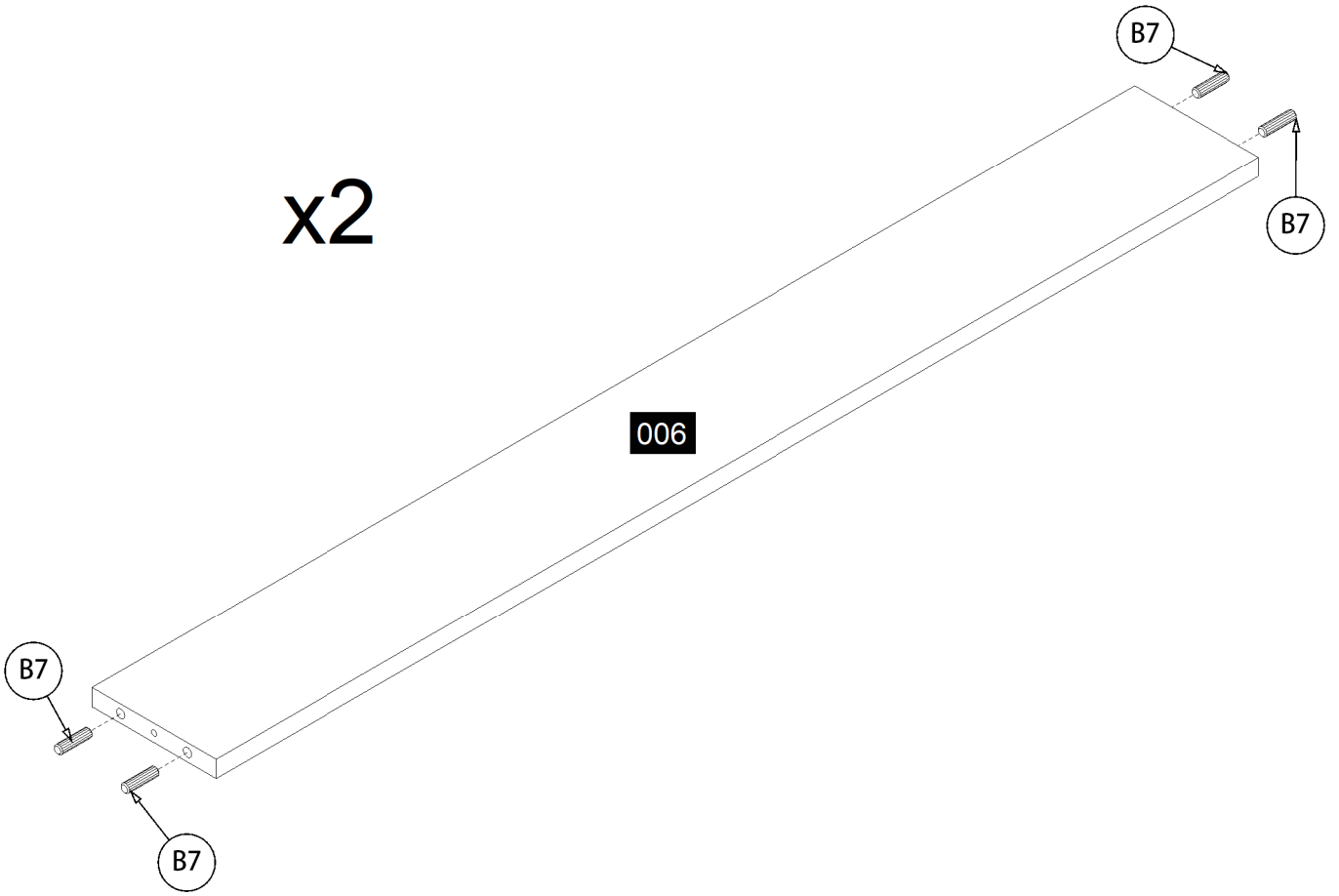

06

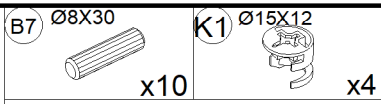

x2

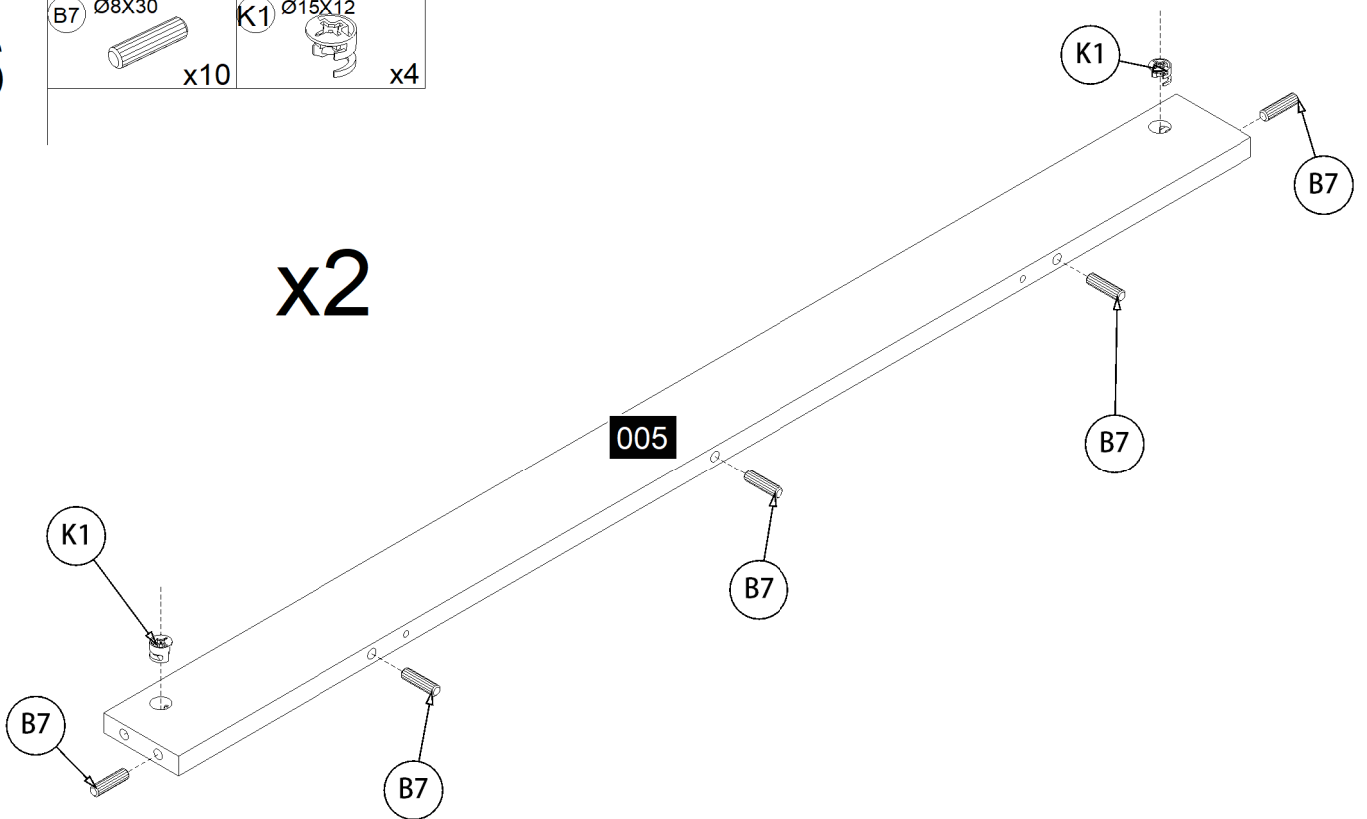

07

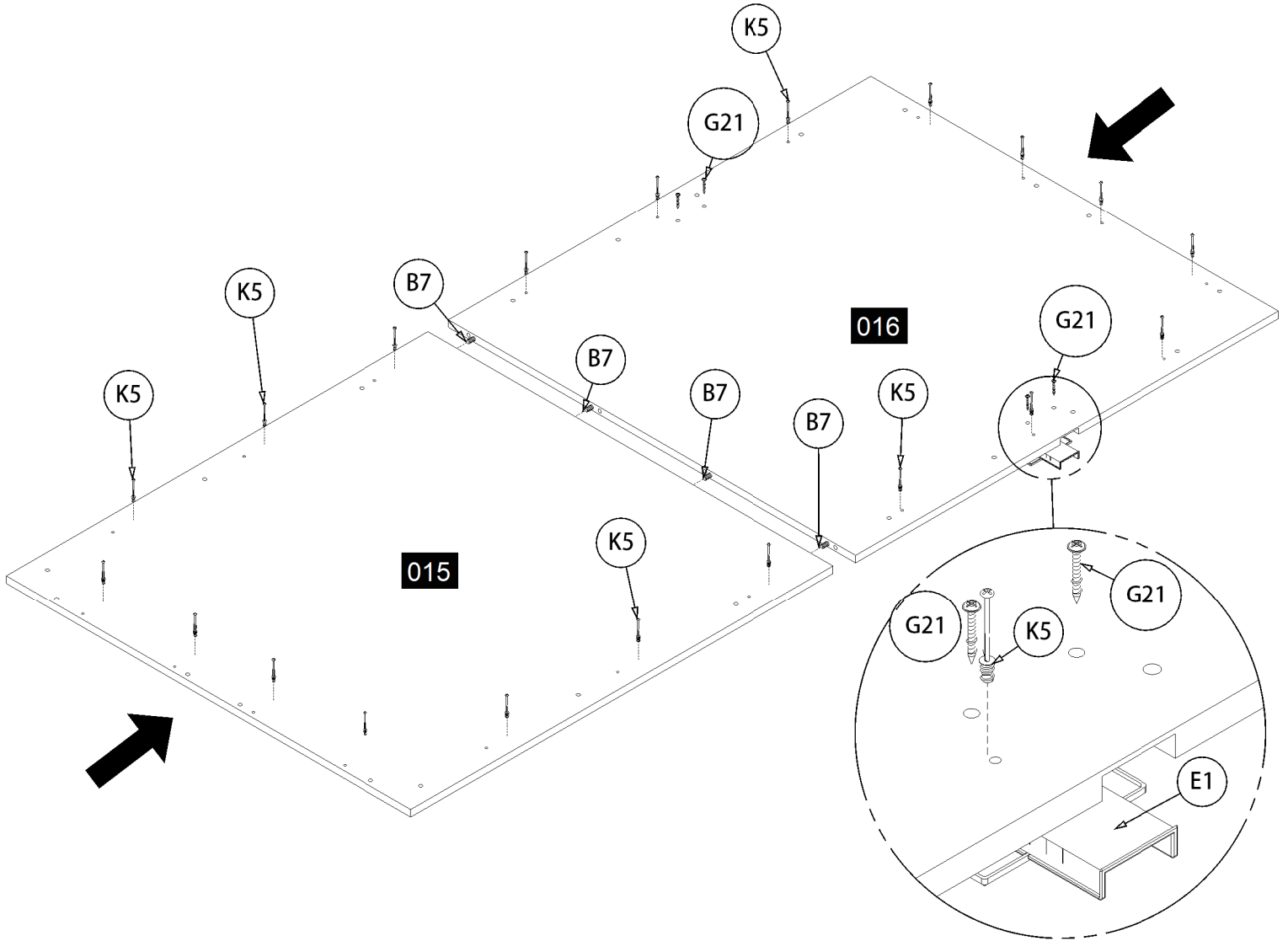
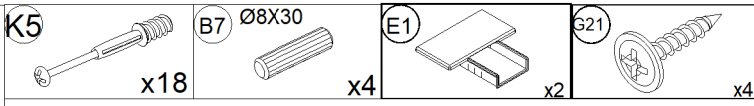

08

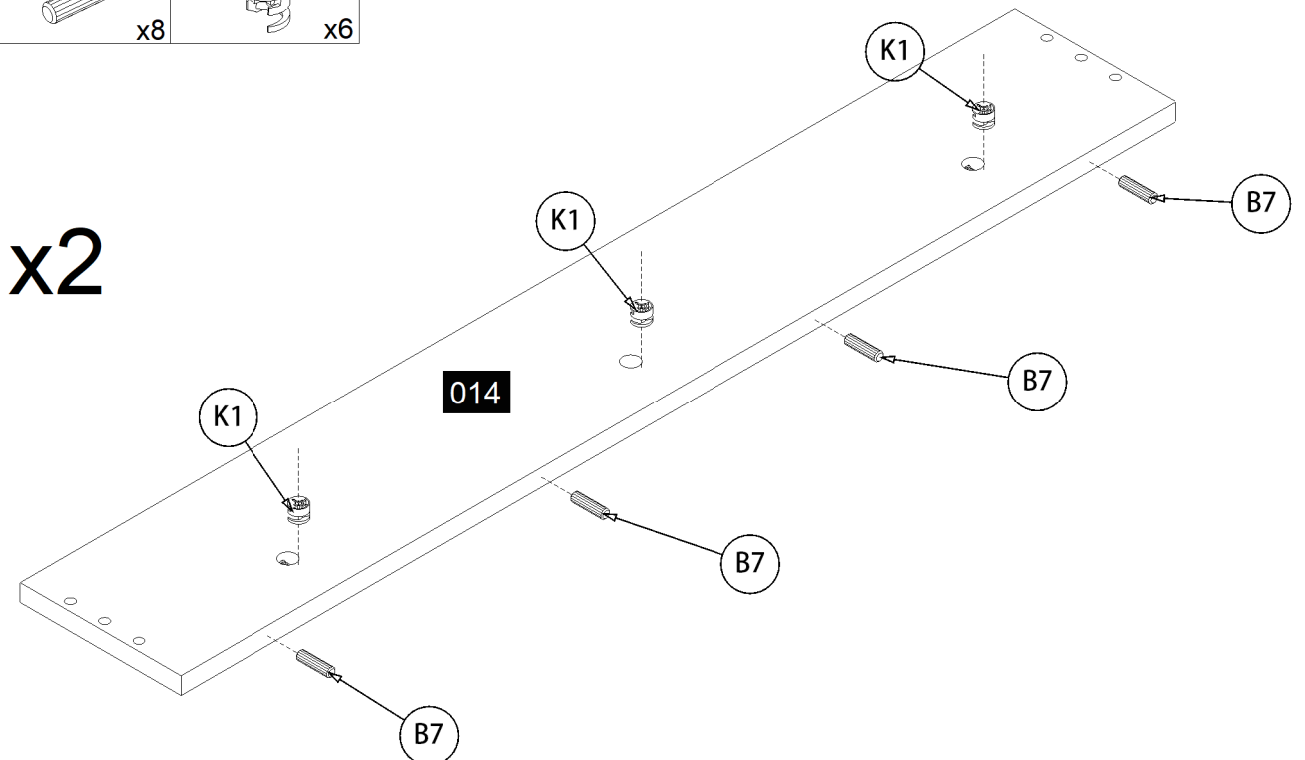
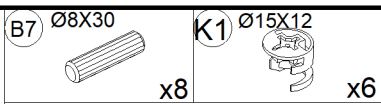

09

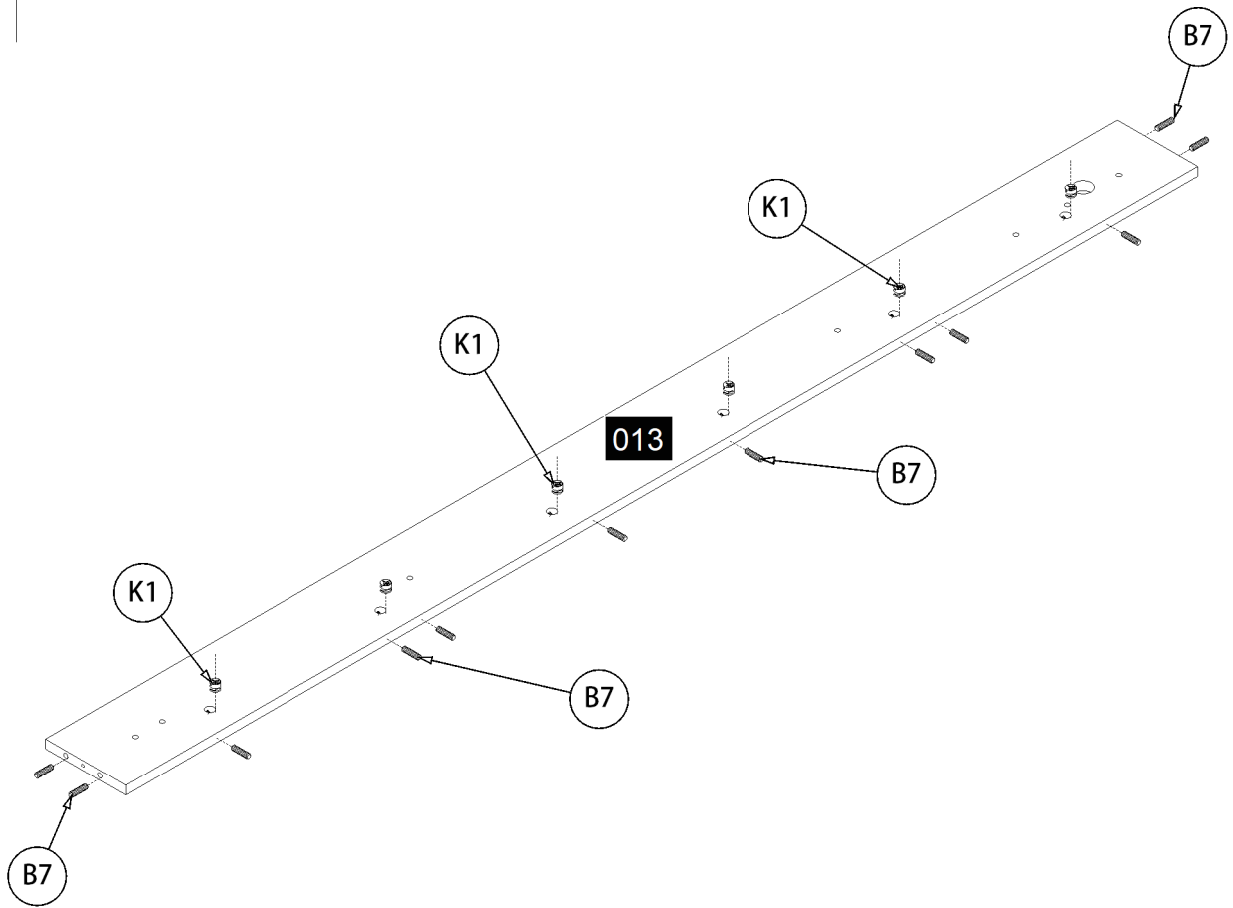
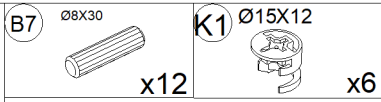

10

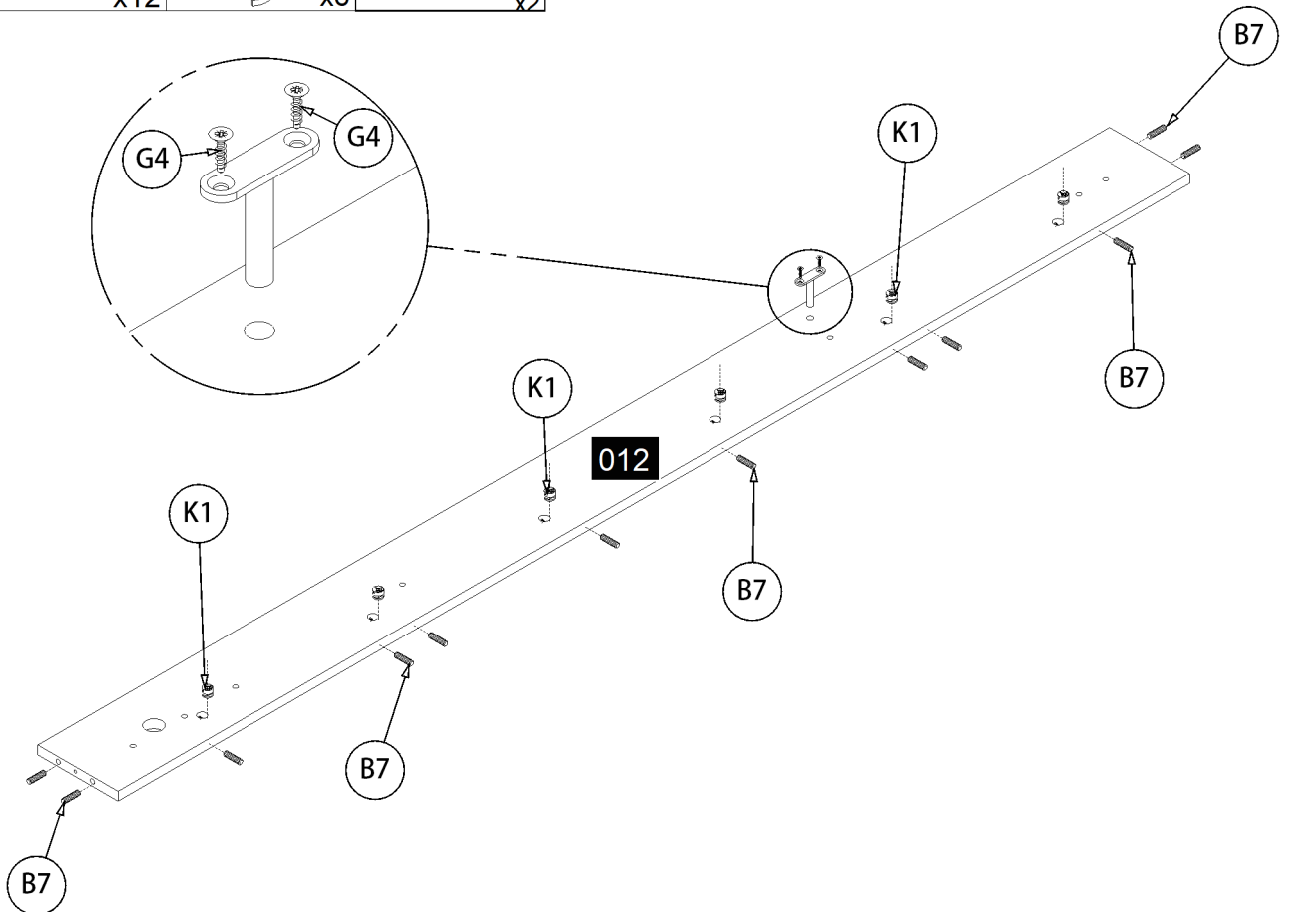
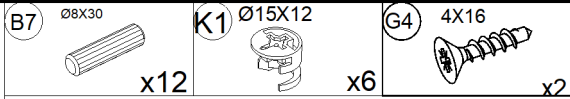

11

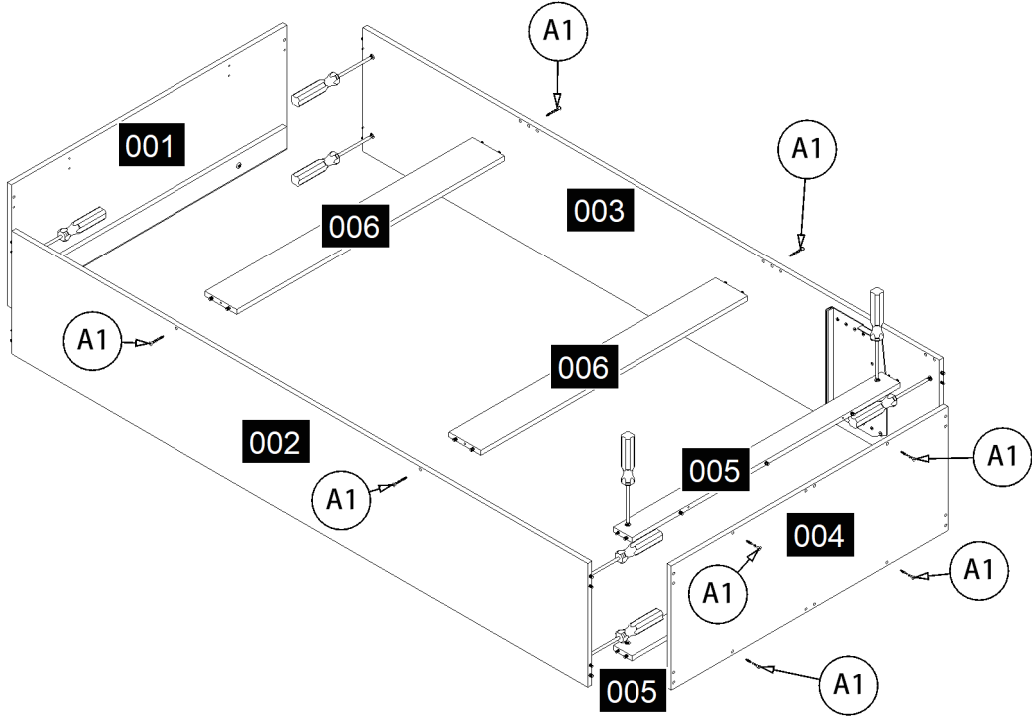
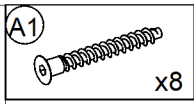

12

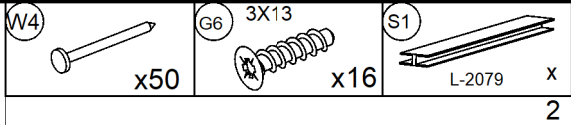

A=B

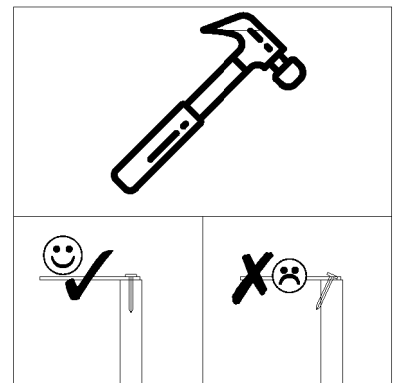
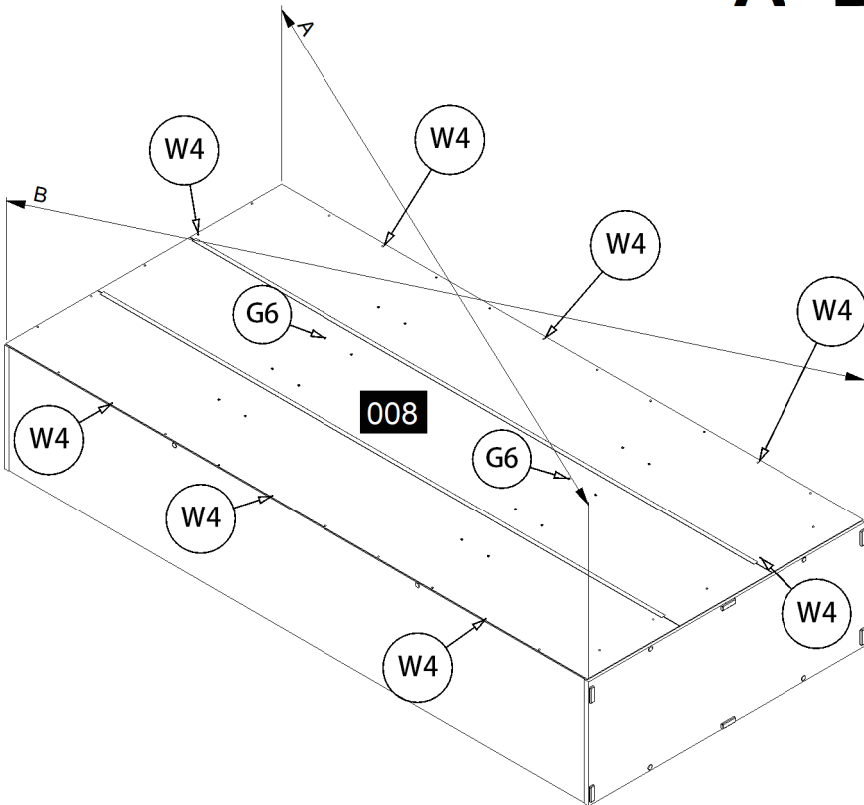
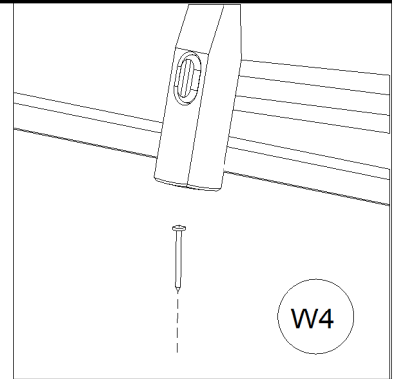

13

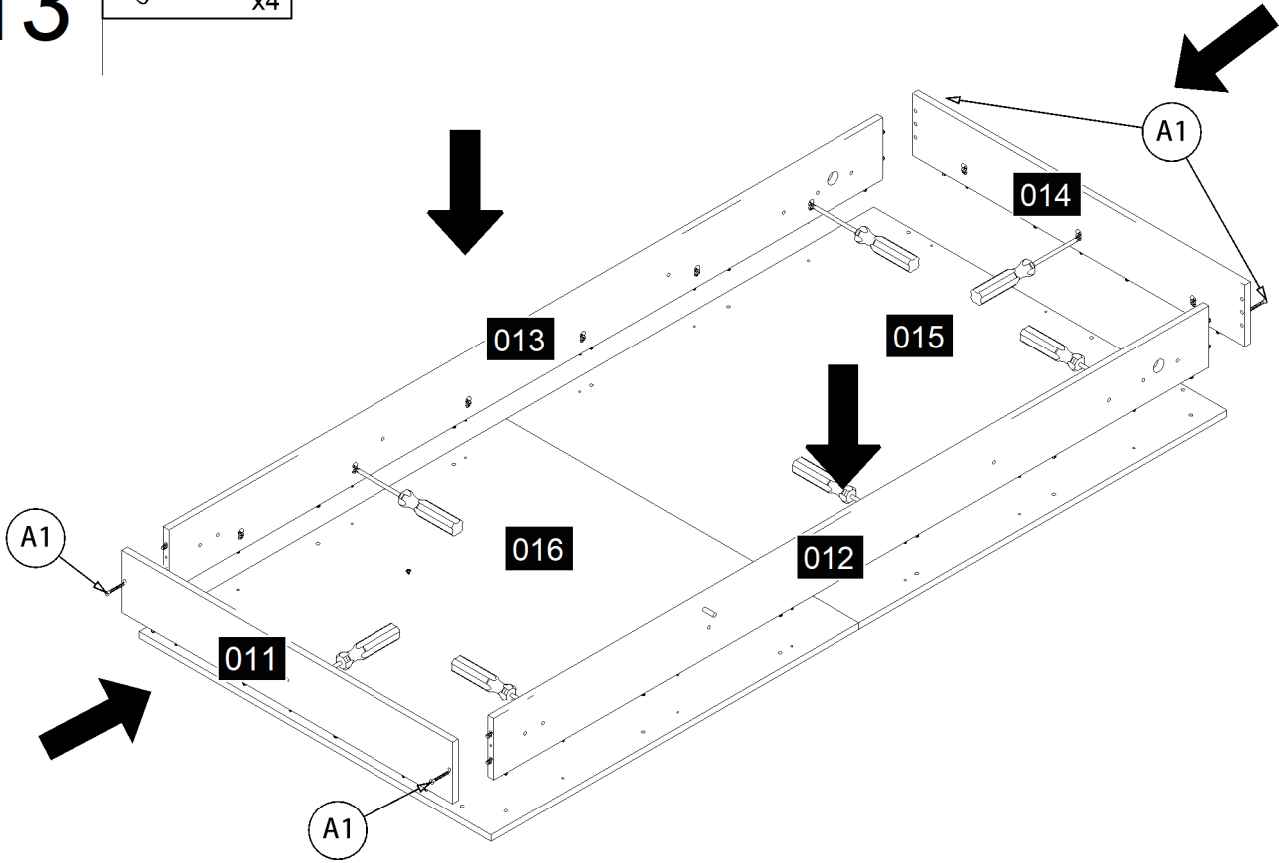
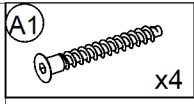

14

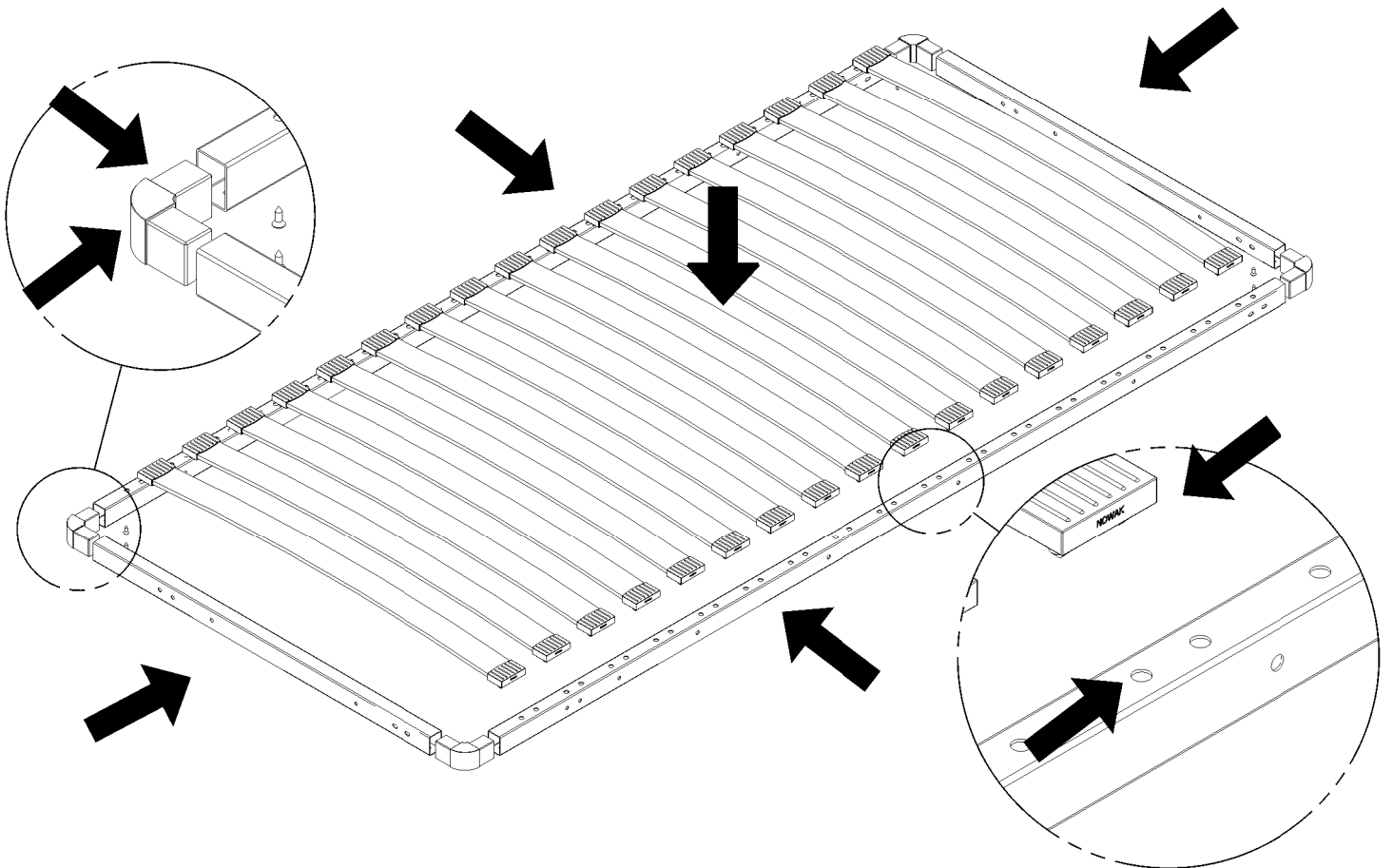

15

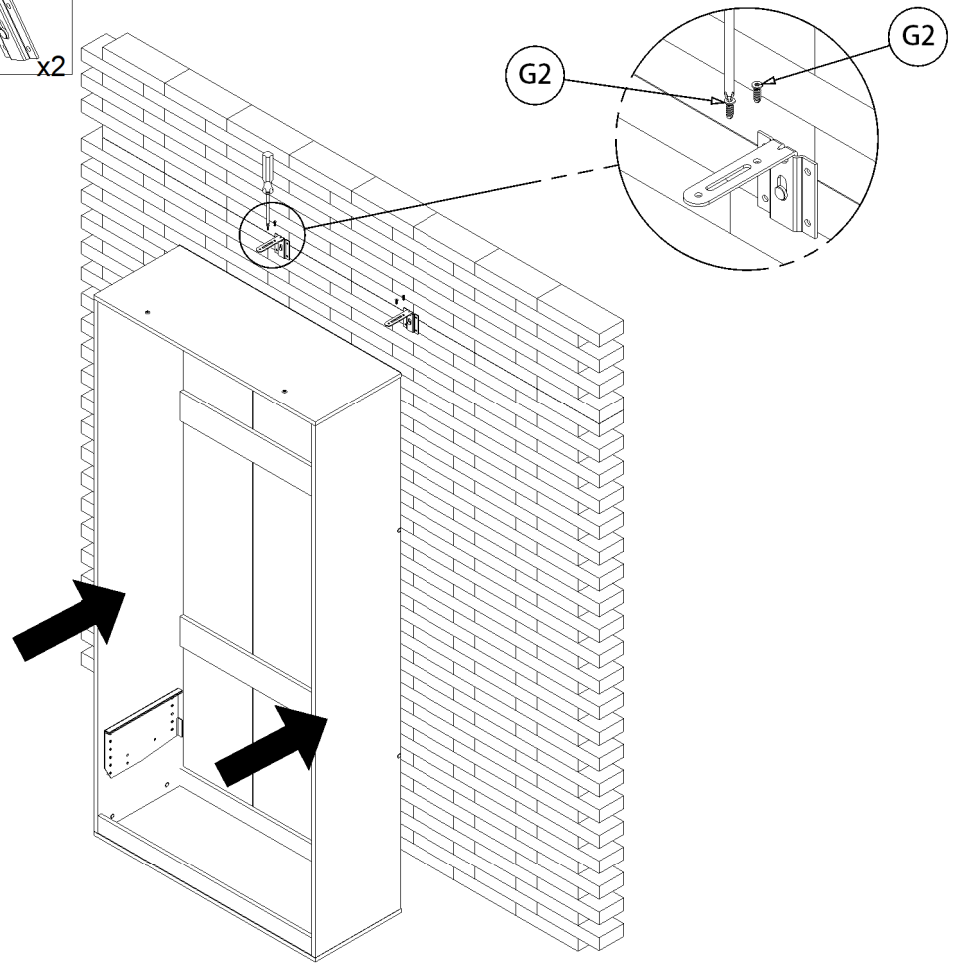
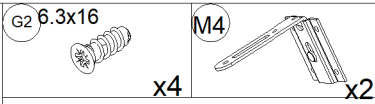

16

