

<b>Montageanleitung</b>	D	<b>Руководство по монтажу</b>	RUS
<b>Installation Instructions</b>	GB	<b>Instrucțiuni de instalare</b>	RO
<b>Instructions d'installation</b>	F	<b>Návod na montáž</b>	SK
<b>Montagehandleiding</b>	NL	<b>Návod k instalaci</b>	CZ
<b>Istruzioni di montaggio</b>	I	<b>Szerelési útmutató</b>	H
<b>Instrukcja montażu</b>	PL	<b>Kurulum Talimatları</b>	TR

01.2019

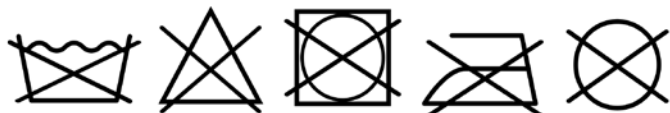
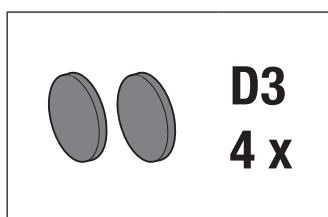
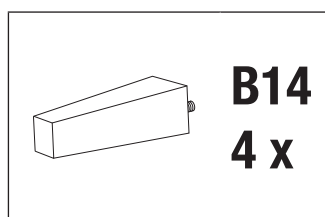
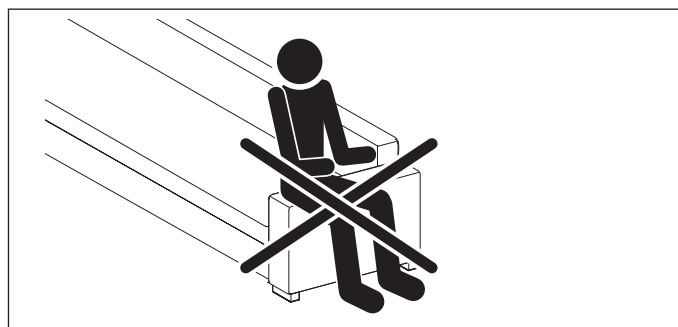
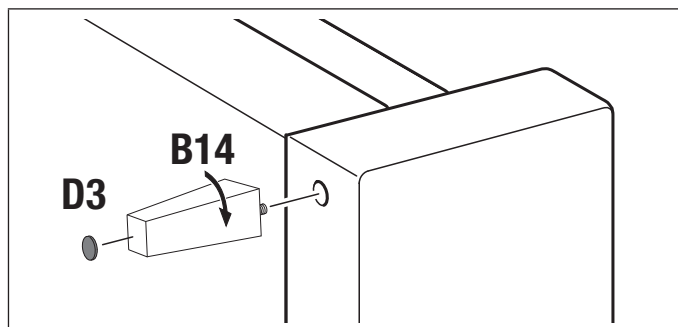
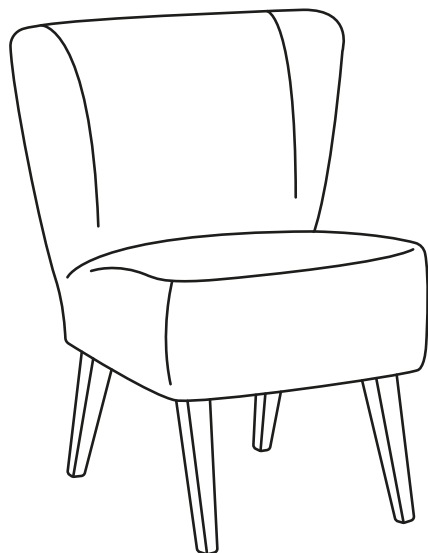

**Service • Assistenza • Dienstverlening • Serwis •  
Servis • Szervis • Сервисная служба**

Name • Nom • Nome • Naam •  
Nazwa • Jméno • Názov • Nev •  
Denumire • Isim • Название

Campi

Typ • Type • Tip • Tipus • Tipo •  
Тип

Sessel

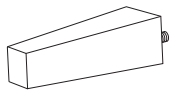
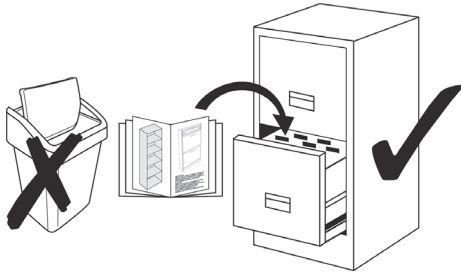
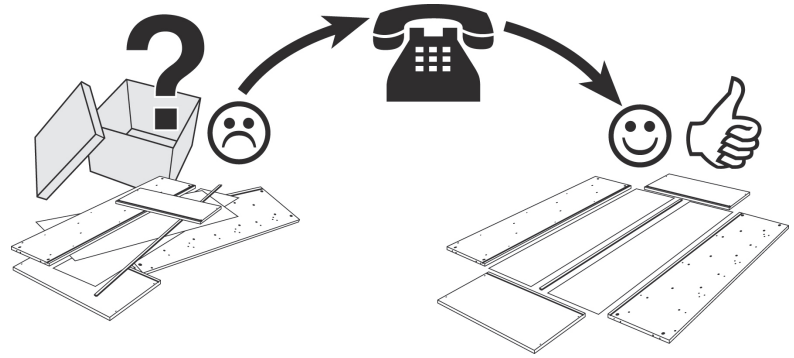

**B14**  
**4 x**

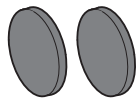

**D3**  
**4 x**

