

1 4551

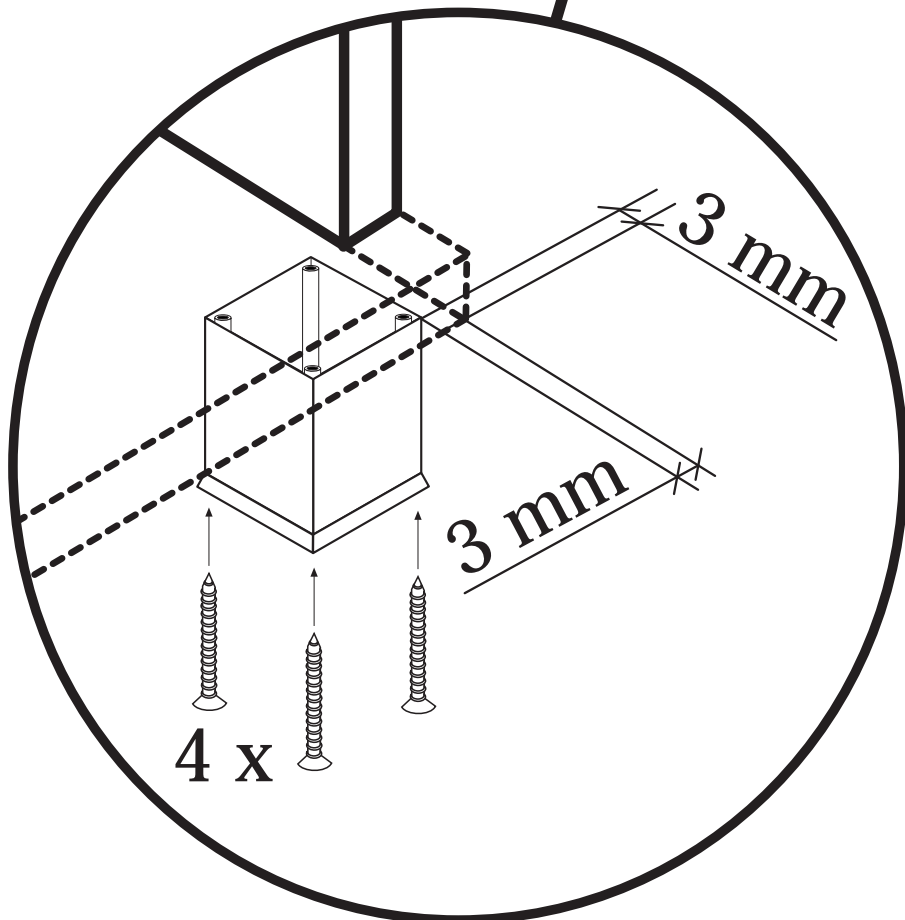

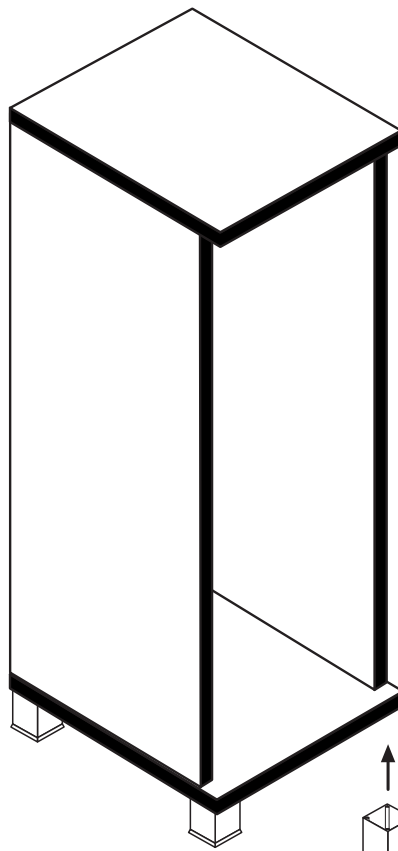

88130.529

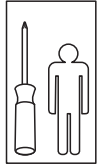
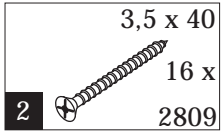
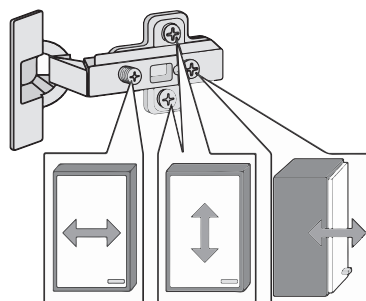
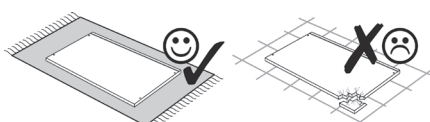
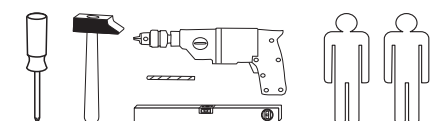
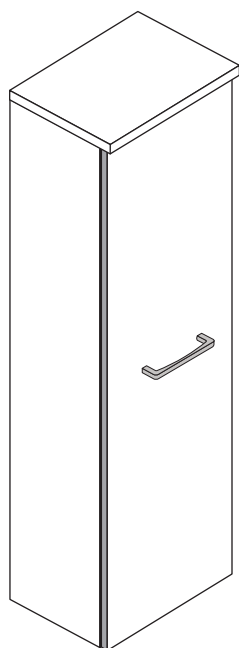

Colli 1

1 4 x 2802	2 4 x 2801	gedämpft 3 2 x 1504	ungedämpft 4 1 x 1505	5 3 x 1613
6 3,5 x 15 8 x 2804	7 8 x 30 8 x 2861	8 2 x 2843	9 4 x 30 4 x 2812	10 5,8 x 55 2 x 2840
11 8 x 30 2 x 2842	12 5/5 x 16 16 x 2821	13 4 x 27 2 x 2829	14 2 x 2865	15 4 x 2552
16 15 x 2862	17 1 x 2863			

Colli 2

18 1 x 1076	19 M4 x 25 2 x 2837
-------------------	------------------------------



Das beigefügte Wandbefestigungsmaterial (Dübel und Schrauben) eignet sich nur für festes Mauerwerk (z.B.: Beton- oder Ziegelwände). Für andere Wandaufbauten sind eventuell Spezialdübel und andere Schrauben notwendig. Ziehen Sie gegebenenfalls eine Fachkraft zu Rate.

De begeleidende wandmontage hardware (pluggen en schroeven) is alleen geschikt voor massief metselwerk (bijvoorbeeld beton of bakstenen muren). Voor andere muur structuren zijn eventueel bijzondere ankerbouten en andere noodzakelijke. Draai indien nodig, een deskundige.

Приложенный материал для крепления к стене (дюбели и винты) пригоден только для жестких кладок (например, бетонные или кирпичные стены). Для других настенных конструкций необходимы смотря по обстоятельствам специальные дюбели и другие винты. При необходимости проконсультируйтесь у специалиста.

Le mur d'accompagnement matériel de montage (chevilles et les vis) n'est adapté que pour la maçonnerie solide (par exemple en béton ou des murs de briques). Pour les structures de mur d'autres sont peut-être spéciale boulons d'ancrage et d'autres nécessaires. Serrer le cas échéant, un expert.

Załączony materiał do mocowania do ściany (kolki rozprężne i wkręty) nadaje się tylko do ścian murowanych (np. z betonu lub cegiel). Do ścian wykonanych w innych technologiach konieczne być mogą specjalne kolki rozprężne i inne wkręty. W razie potrzeby skorzystaj z fachowej pomocy

Il muro di accompagnamento hardware di montaggio (tasselli e viti) è'e adatto solo per muratura piena (ad esempio calcestruzzo o muratura). Per le altre strutture murarie sono forse speciali bulloni di ancoraggio e necessari di altri. Serrare se necessario, un esperto.

The accompanying wall mounting hardware (anchors and screws) is suitable only for solid masonry (eg concrete or brick walls). For other wall structures are possibly special anchor bolts and other necessary. Tighten if necessary, an expert.

Ekteki duvara sabit montaj malzemeleri (dübel ve vidalar), sadece sağlam duvarlar için (örnek: beton veya tuğla) elverişlidir. Başka duvarlar için özel dübeller ve farklı vidalar gerekebilir. Gerektiğinde bir uzmana danışınız.

Colli 1

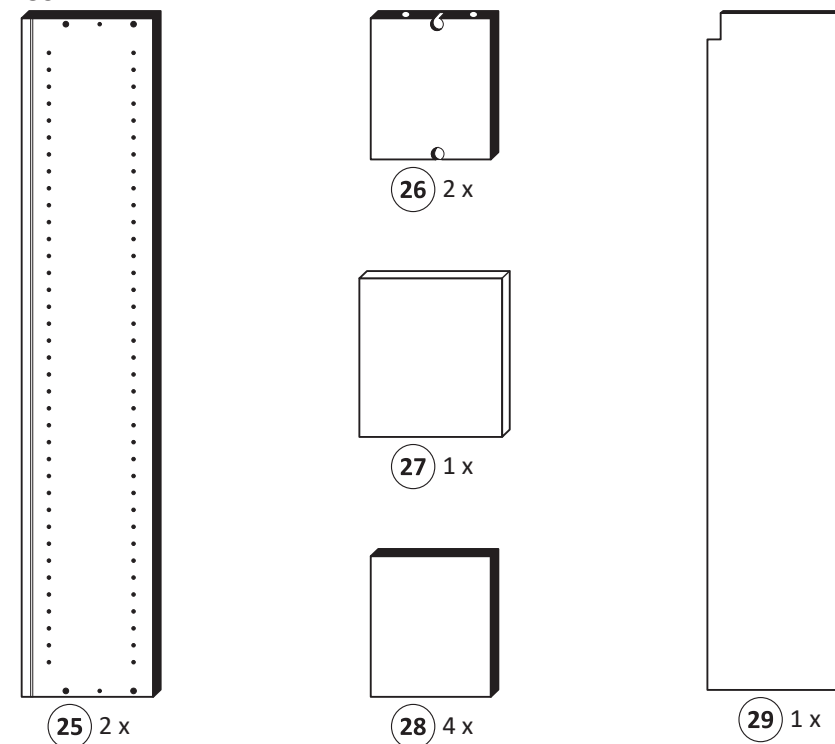

Colli 2

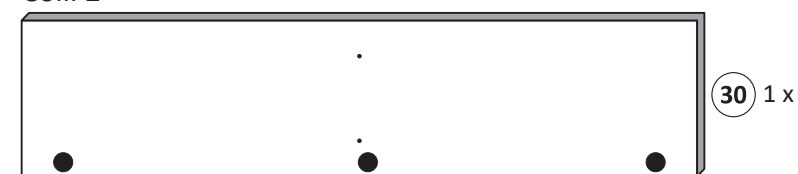

1

1 4 x 2802	5 2 x 1613	8 2 x 2843	9 4 x 30 4 x 2812	12 5/5 x 16 16 x 2821
------------------	------------------	------------------	----------------------------	--------------------------------

ACHTUNG !
Montagebeispiel Rechtsanschlag !
Soll die Tür links angeschlagen werden müssen die Kreuzmontageplatten 5 auf dem linken Seitenteil 25 L montiert werden.

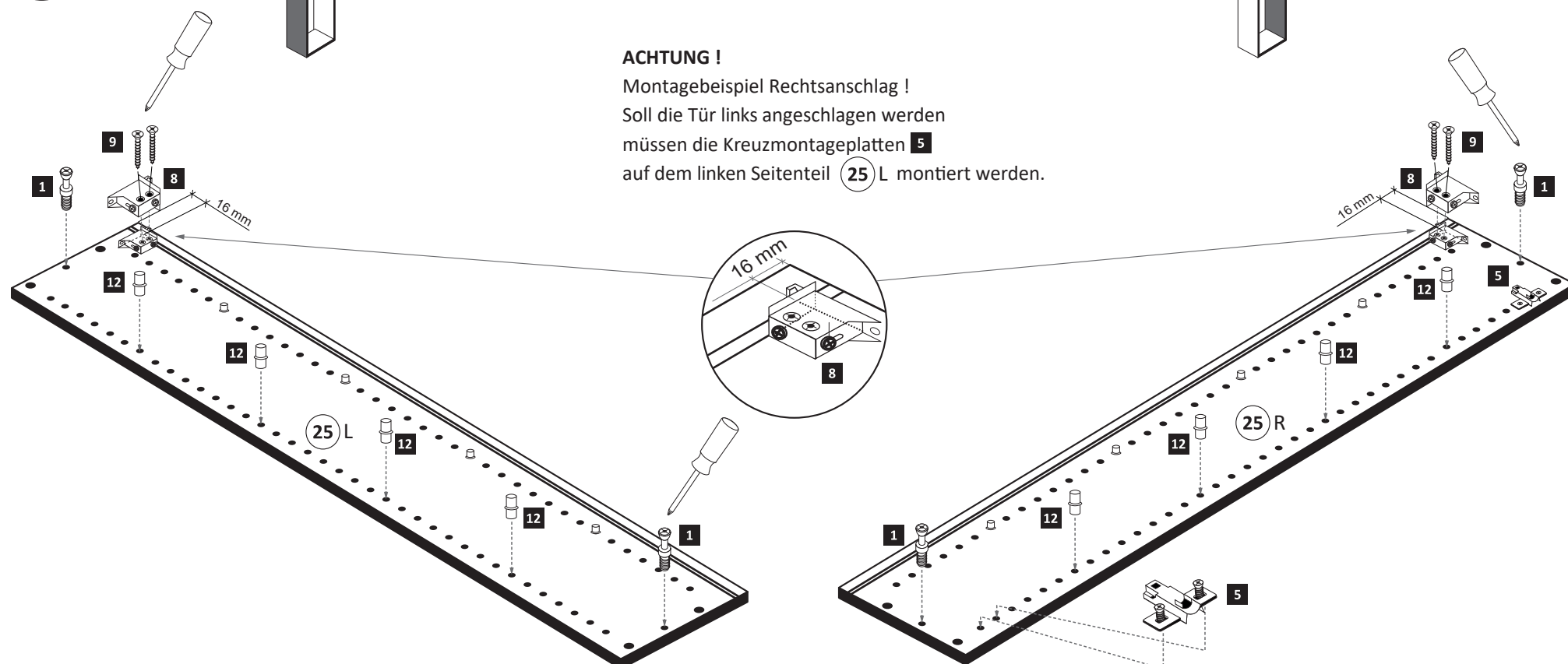

2

2 4 x 2801	7 8 x 30 8 x 2861	17 1 x 2863
------------------	----------------------------	-------------------

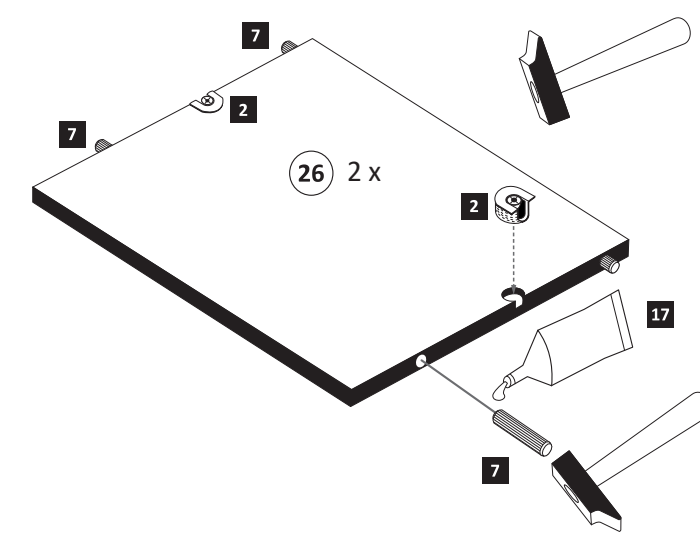

3

3,5 x 15	2 x	2804
----------	-----	------

17	1 x	2863
----	-----	------

D Leim
GB Glue
NL Lijm
PL Klej
TR Tutkal
F Colle
I Colla

20 min.

5

gedämpft	2 x	1504
----------	-----	------

ungedämpft	1 x	1505
------------	-----	------

5	1 x	1613
---	-----	------

3,5 x 15	6 x	2804
----------	-----	------

14	2 x	2865
----	-----	------

Scharniermontage

Scharnier lösen

1. (drücken)

7

18	1 x	1076
----	-----	------

19	2 x	2837
----	-----	------

M4 x 25

4

15	4 x	2552
----	-----	------

16	15 x	2862
----	------	------

6

13	4 x	27
----	-----	----

2 x	2829
-----	------

1. (drücken)

2.

oben

8

10	2 x	5,8 x 55
----	-----	----------

11	2 x	8 x 30
----	-----	--------

2 x	2842
-----	------