

Lola chair

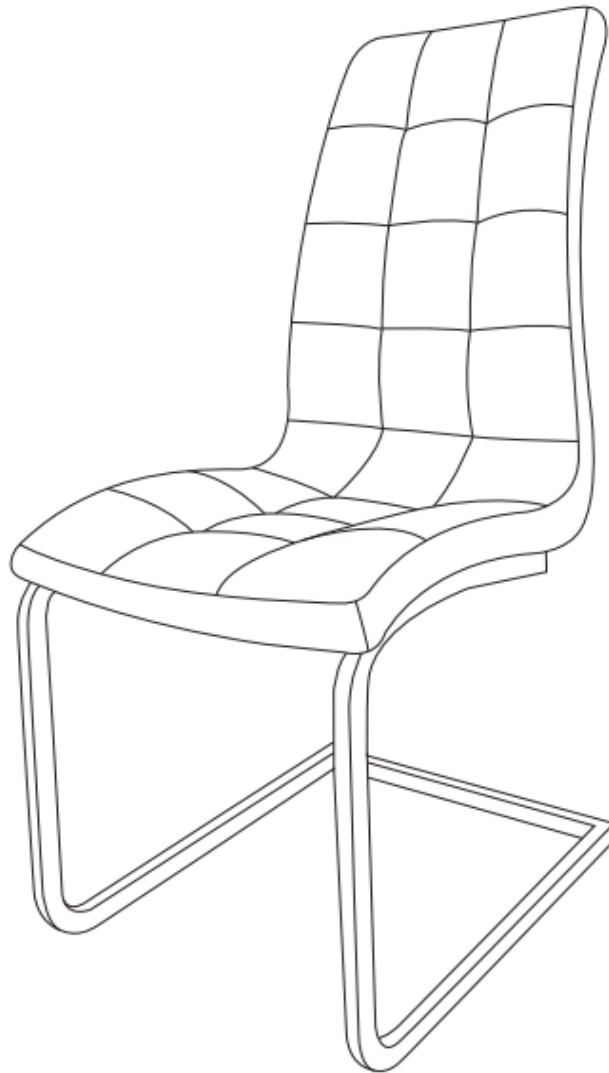

(D) Montageanleitung

(FR) Notice de montage

(NL) Handleiding voor de montage

(CZ) Montážní návod

(HU) Szerelési útmutató

(TR) Montaj talimatı

(GB) Assembly instructions

(IT) Istruzioni di montaggio

(PL) Instrukcja montażu

(SK) Návod na montáž

(RO) Instrucțiuni de montaj

(RU) Инструкция по монтажу

**Service • Assistenza • Dienstverlening • Serwis
Servis • Szerviz • Сервисная служба**

Name • Nom • Nome • Naam • Nazwa • Jméno • Názov • Név • Denumire • İsim • Название	
Nr. • No. • N° • Номер • Č • Sz	
Тур • Туре • Тір • Тірус • Тіро • Тип	
	

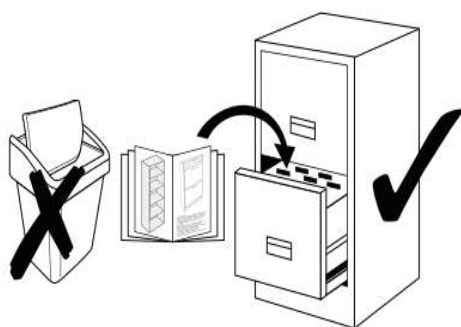
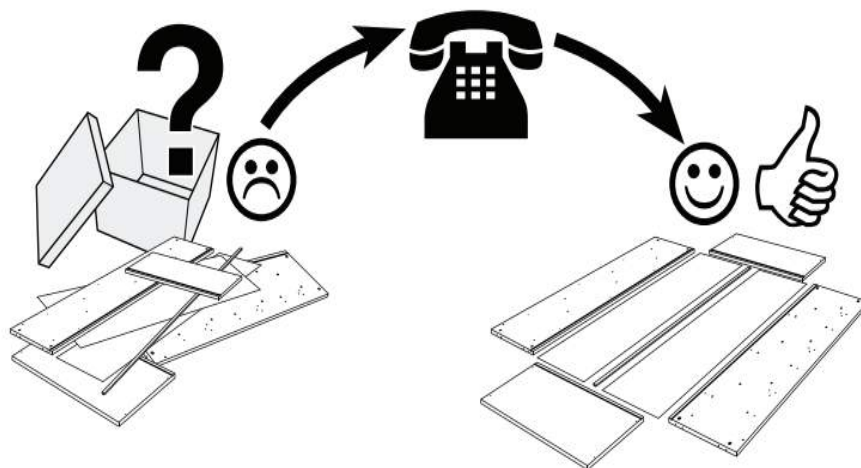

1

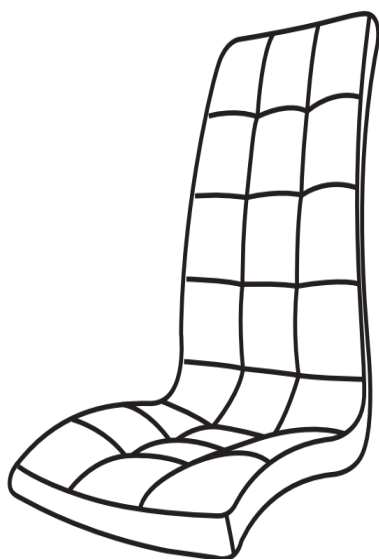



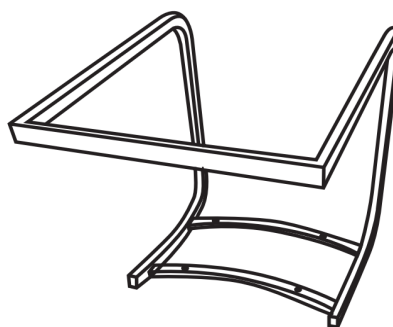

2

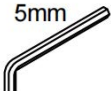

1X1

2X1

M6x35mm  AX4	M 6x1.5mm  Bx4	5mm  C x1	 Dx6
---	---	--	--

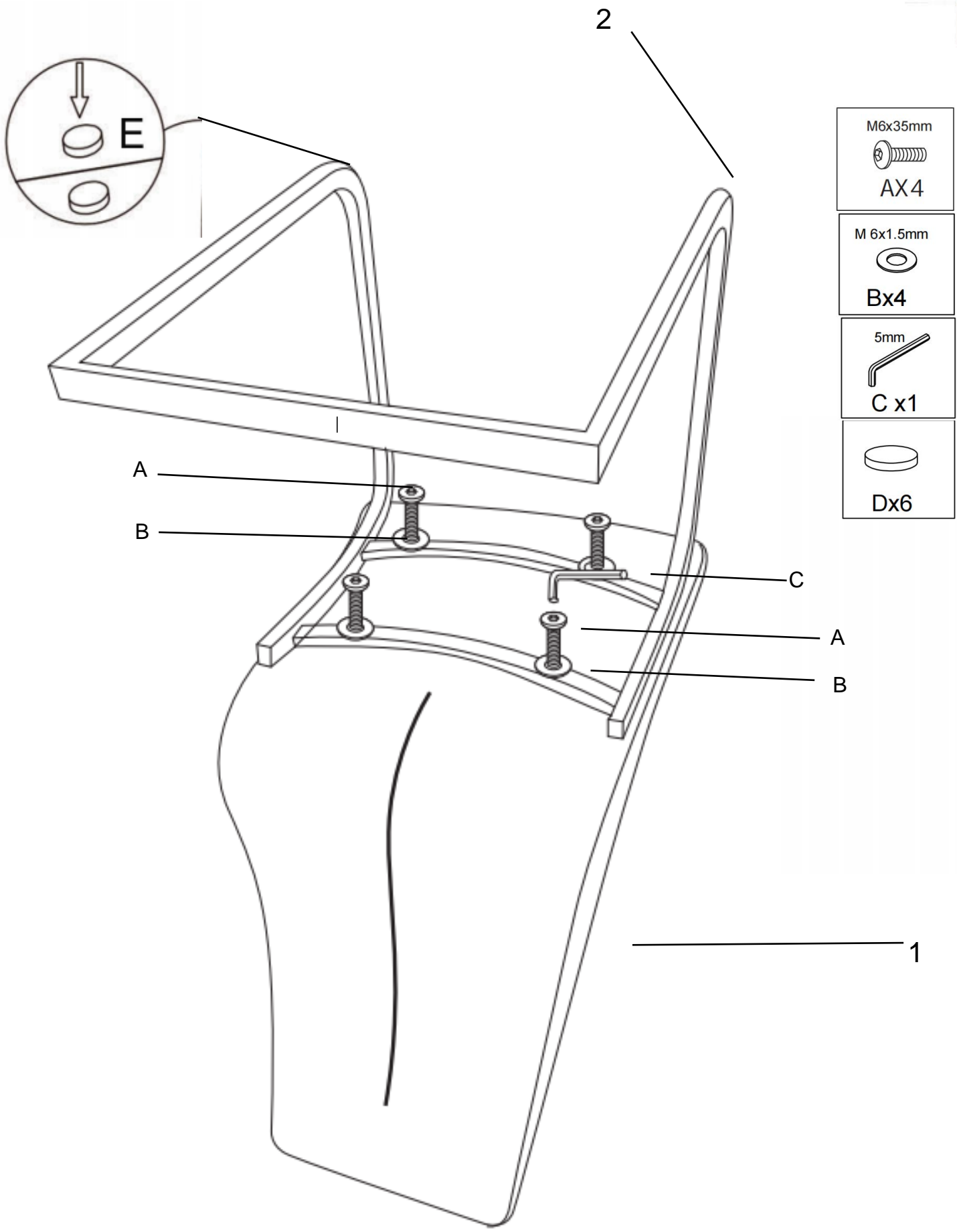



1	D	Ziehen Sie alle Schrauben sowie tragende Verbindungsteile nach ca. 5 Wochen nach, um eine dauerhafte Standsicherheit zu gewährleisten.
	GB	After approx. 5 weeks, tighten all screws and load-bearing connecting parts to ensure permanent stability.
	FR	Resserrez toutes les vis ainsi que les pièces de fixation au bout d'environ 5 semaines pour garantir une sécurité de fixation durable.
	IT	Ristringere tutte le viti e giunture dopo ca. 5 settimane, al fine di garantire una durevole solidità.
	NL	Draai alle schroeven en ook dragende verbindingstukken na ca. 5 weken nog eens vast, zodat een continue stabiliteit wordt gegarandeerd.
	PL	Prosimy po ok. 5 tygodniach dokręć wszystkie śruby w elementach łączeniowych. Zagwarantuje to Państwu trwałość i stabilność połączeń.
	CZ	Dotáhněte všechny šrouby a nosné spojovací díly přibližně po 5 týdnech, aby se zaručila trvalá stabilita.
	SK	Po cca 4 týždňoch dotiahnite skrutky, aby bola zaručená ich trvalá stabilita.
	HU	Húzza utána – kb. 5 hét múlva – az összes csavart és a teherhordó összekötő-alkatrészeket a biztonság érdekében.
	RO	Pentru a asigura o stabilitate de durată, strângeți după cca. 5 săptămâni toate șuruburile, precum și toate elementele portante de legătură.
	TR	Tüm vida ve taş y c bağlant parçalar n kal c bir duruş güvenliğini sağlamak için yaklaşık k 5 hafta sonra tekrar s k n z.
RU	Подкрутите все болты, а также несущие соединительные детали припл. через 5 недель для обеспечения устойчивости в течение длительного времени.	
2	D	Bitte nur mit einem Staubtuch oder leicht feuchtem Lappen reinigen. Keine scheuernden Putzmittel verwenden.
	GB	Please only clean with a duster or a damp cloth. Do not use any abrasive cleaners.
	FR	Veillez nettoyer uniquement avec un chiffon à poussière ou un chiffon légèrement humide. Ne pas utiliser de détergent abrasif.
	IT	Si raccomanda di pulire solo con un panno per la polvere o uno strofinaccio umido. Non utilizzare detersivi abrasivi.
	NL	Reinig alleen met een stofdoek of een lichtjes vochtige doek. Gebruik geen schurende poetsmiddelen.
	PL	Czyszczenie należy wykonać wyłącznie za pomocą ściereczki lub lekko nawilżonego ręcznika. Nie stosować środków czyszczących do szorowania.
	CZ	Čistěte prosím jen prachovkou nebo lehce navlhčeným hadrem. Nepoužívejte drhnoucí čisticí prostředky.
	SK	Na čistenie používajte len prachovku alebo zľahka navlhčenú utierku. Nepoužívajte žiadne drhnúce čistiace prostriedky.
	HU	Kérjük, csak portórlő kendővel vagy enyhén nedves ronggyal tisztítsa. Ne használjon dörzshatású tisztítószeret.
	RO	Vă rugăm să utilizați la curățare exclusiv o cârpă de șters praful sau o cârpă ușor umezită. Nu utilizați substanțe de curățat abrazive.
	TR	Lütfen sadece bir toz beziiyle veya hafif nemli yumuşak bir bezle siliniz. Aşındırıcı temizlik malzemeleri kullanmayınız.
RU	Очищайте от пыли тряпкой или слегка влажной ветошью. Не допускается применение чистящих средств, не предназначенных для ухода за мебелью.	

TRAVIS

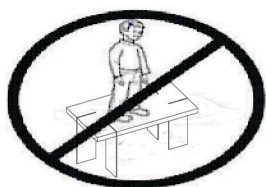
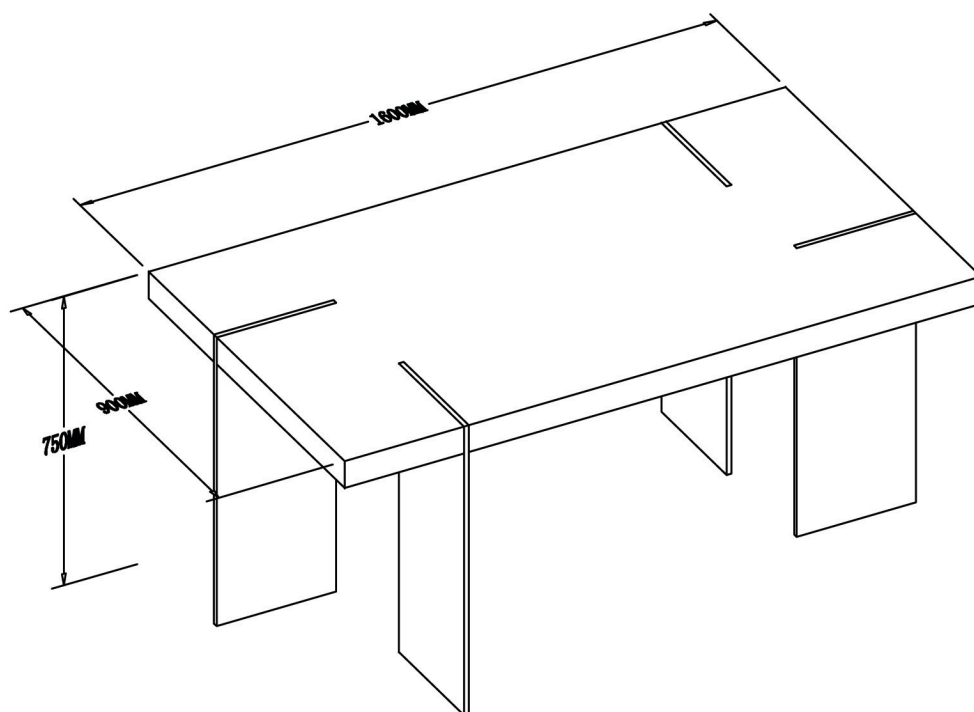

- | | |
|---|--------------------------------------|
| (D) Montageanleitung | (GB) Assembly Instructions |
| (FR) Notice de montage | (IT) Istruzioni di montaggio |
| (NL) Handleiding voor de montage | (PL) Instrukcja montażu |
| (CZ) Montážní návod | (SK) Návod na montáž |
| (HU) Szerelési útmutató | (RO) Instrucțiunile de montaj |
| (TR) Montaj talimatı | (RU) ИНСТРУКЦИЯ ПО МОНТАЖУ |

**Service • Assistenza • Dienstverlening • Serwis
Servis • Szerviz • Сервисная служба**





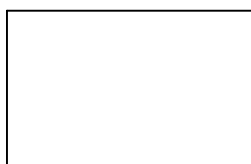
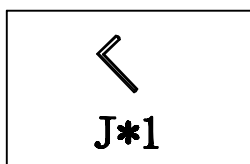
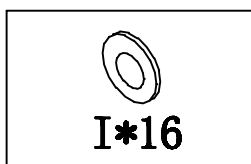
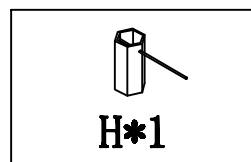
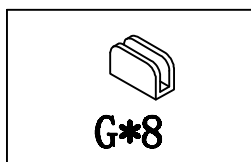
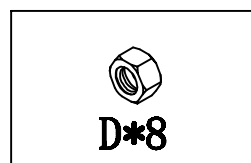
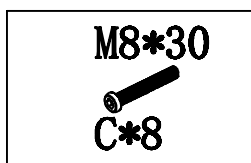
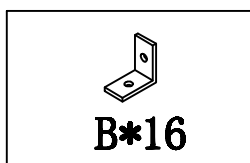
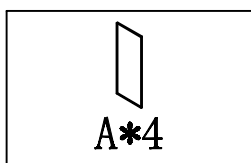
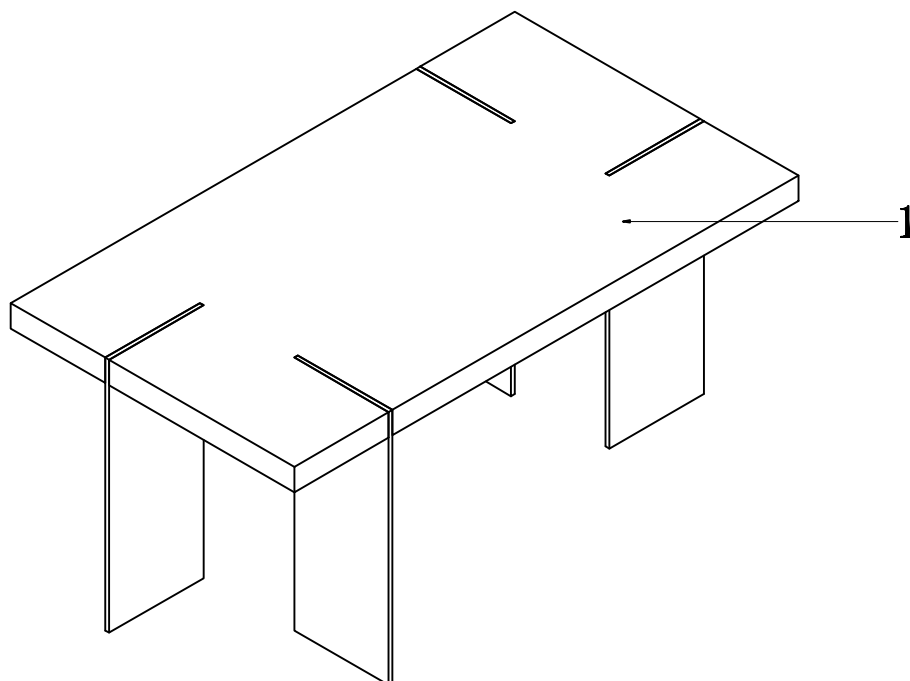
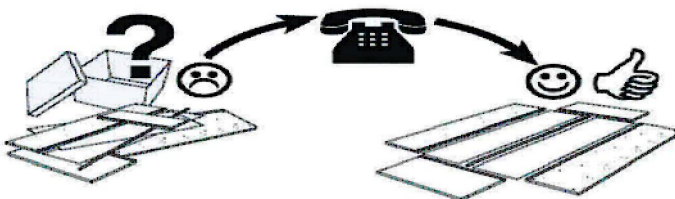

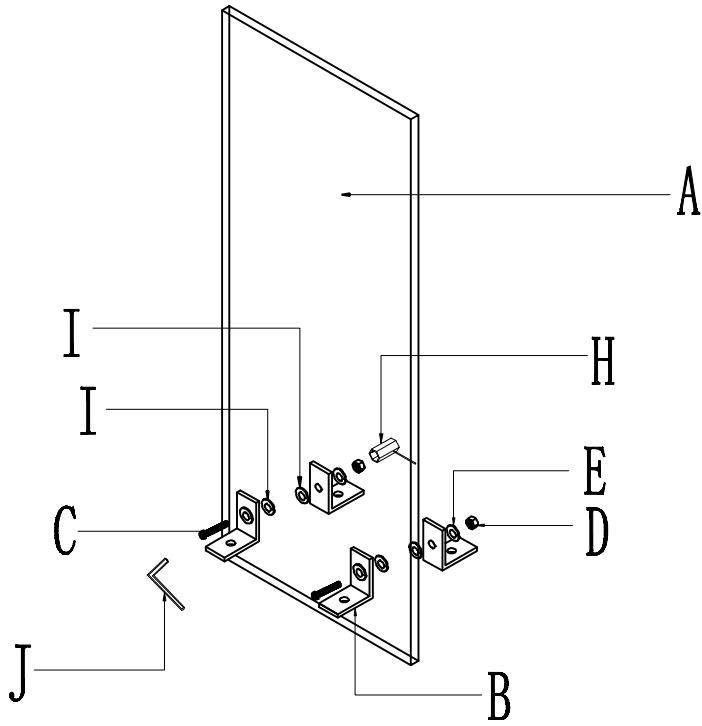

Name • Nom • Nome • Naam •
Nazwa • Имя • Názov • Név •
Dělník • Імя • Називня

Nr. • No. • N° • Номер • Č. • Sz
Typ • Type • Tir • Típus • Tipo •
Typ







1

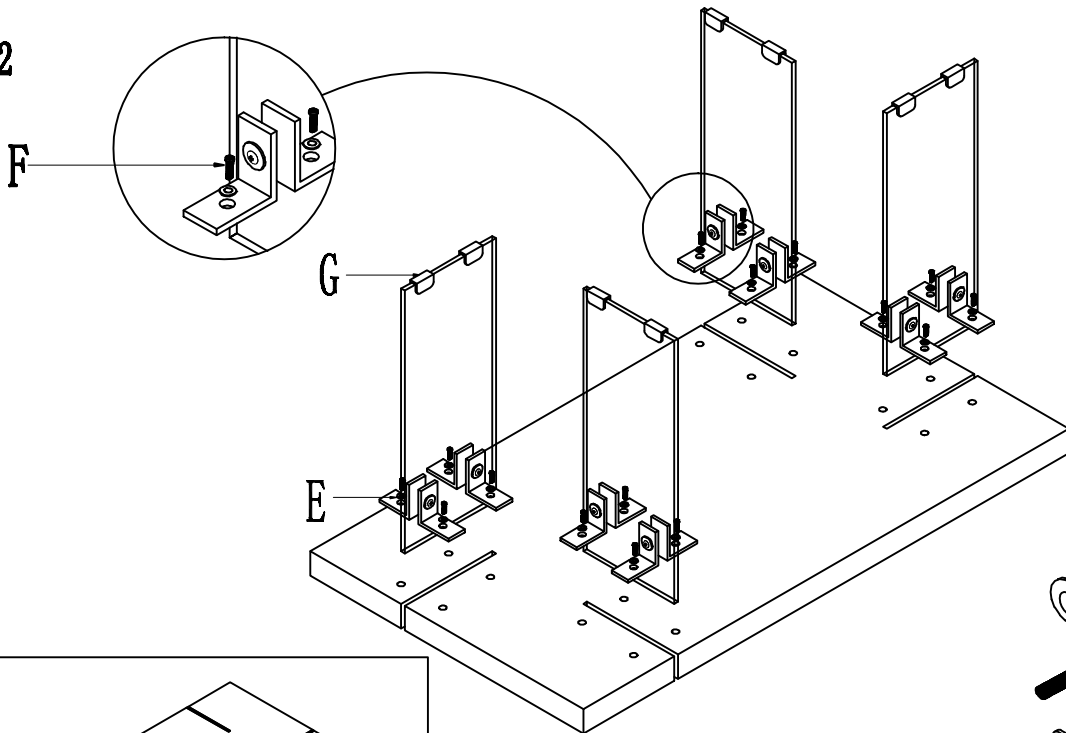

-  A*4
-  B*16
-  C*8
-  D*8
-  E*16
-  H*1
-  I*16
-  J*1

2



-  E*16
-  F*16
-  G*8

