

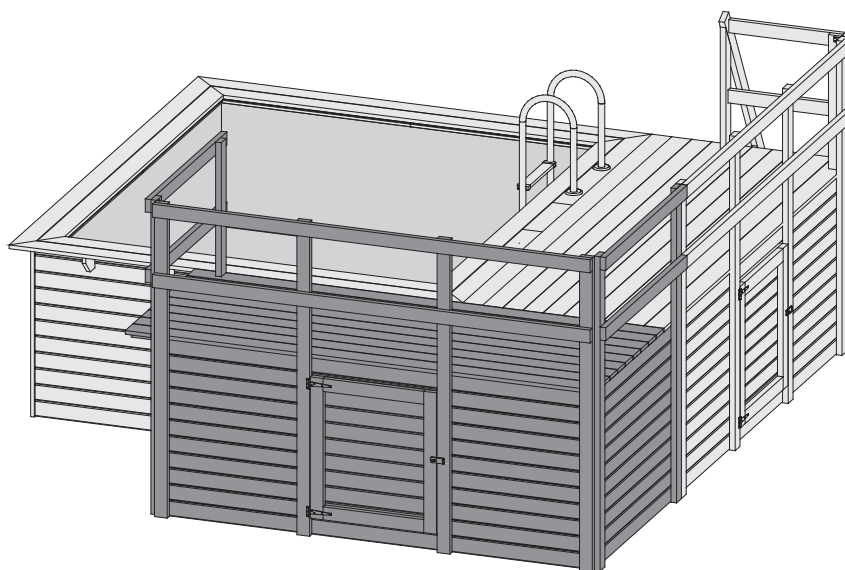

19749

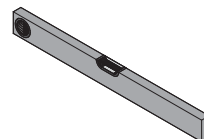

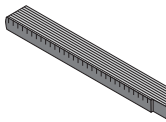
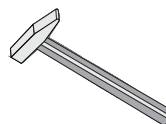
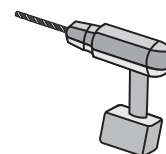
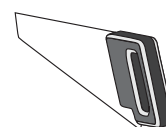

-  **Aufbauanleitung**
-  **Building Instructions**
-  **notice de montage**
-  **montagehandleiding**
-  **Montagevejledning**
-  **Instrucciones de construcción**
-  **Istruzioni per il montaggio**
-  **Montážní návod**





 Vergleichen Sie zuerst die Material-liste mit Ihrem Paketinhalt! Bitte haben Sie Verständnis, dass Beanstandungen nur im nicht aufgebauten Zustand bearbeitet werden können!

 Vergelijk eerst de lijst van materialen met de inhoud van uw pakket! Reclamaties kunnen alleen in behandeling worden genomen zolang de onderdelen nog niet zijn gemonteerd!

 Confrontate questa distinta materiali prima con il contenuto del pacchetto! Vi preghiamo di comprendere che eventuali reclami possono essere accolti solo prima del montaggio!

 First compare the list of materials with your package contents! Please understand that complaints can be processed in the non-built status only!

 Start med at kontrollere materialelisten med indholdet af den leverede pakke! Vi gør venligst opmærksom på at reklamationer kun kan behandles for materialer som ikke er blevet bearbejdet!

 Nejprve překontrolujte obsah balení podle materiálového listu! Mějte pochopení pro to, že případnou reklamaci se můžeme zabývat pouze tehdy, když díly nebudou smontované! Za pomoci tohoto seznamu můžete jednotlivé díly přiřadit k montážnímu návodu.

 Commencez par comparer la liste du matériel avec le contenu de votre paquet! Sachez que nous traitons uniquement les réclamations concernant le matériel à l'état non monté!

 En primer lugar, compare la lista de material con el contenido del paquete. Rogamos entienda que las reclamaciones sólo pueden ser tramitadas antes de montar el objeto!

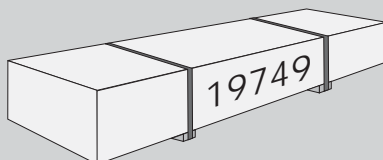

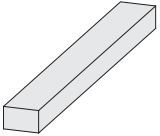
			
1 x B1	1388 x 140 x 26 mm	ID 25878	
9 x B2	3087 x 140 x 26 mm	ID 25880	
6 x B3	322 x 90 x 40 mm	ID 25857	
2 x B4	1092 x 90 x 40 mm	ID 34272	
4 x B5	1222 x 90 x 40 mm	ID 25856	
6 x B6	1450 x 90 x 40 mm	ID 25879	
8 x B7	2177 x 90 x 40 mm	ID 25297	
2 x B8	2852 x 90 x 40 mm	ID 25298	
4 x B9	3087 x 90 x 40 mm	ID 25300	

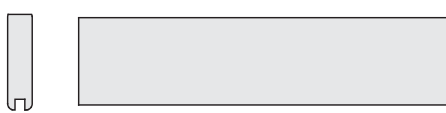
			
2 x W4	1490 x 102 x 28 mm	ID 25294	
1 x W5	3032 x 102 x 28 mm	ID 25295	

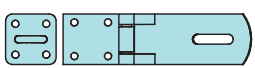
		
1 x		ID 3724

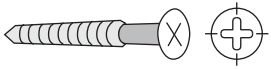
		
20 x	4 x 30 mm	ID 3686
80 x	4 x 35 mm	ID 3687
250 x	4 x 50 mm	ID 3688
60 x	4 x 70 mm	ID 3689

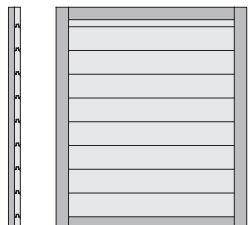
			
1 x D1	980 x 890 x 28 mm	ID 25834	

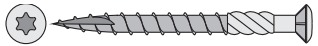

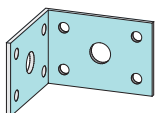
		
150 x	5 x 50 mm	ID 57137

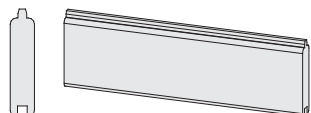
		
4 x		ID 21292

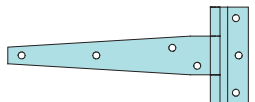
			
18 x W1	1066 x 121 x 28 mm	ID 25292	
20 x W2	1490 x 121 x 28 mm	ID 25269	
1 x W3	3032 x 121 x 28 mm	ID 25293	

		
2 x		ID 3716

-  Nur geeignet für
-  Only suitable for
-  Seulement adapté pour
-  Alleen voor
-  Kun velegnet til

-  Sólo adecuado para
-  Solo adatto per
-  Pouze vhodné pro

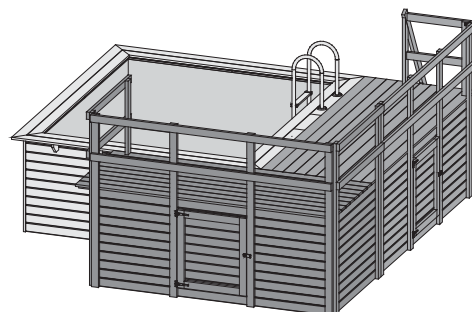
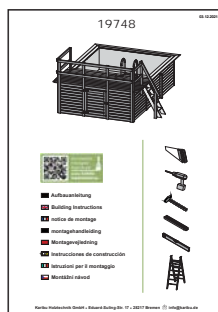



 Um das Ertrinken von Kindern zu verhindern, wird empfohlen, den Zugang zum Schwimmbecken mit einer Schutzvorrichtung zu sichern!

 For at forhindre drukning af børn anbefales det at sikre adgang til swimmingpoolen med en beskyttelsesanordning!

 To prevent the drowning of children, it is recommended to secure access to the swimming pool with a protective device!

 Para evitar que los niños se ahoguen, se recomienda asegurar el acceso a la piscina con un dispositivo de protección.





 Pour éviter la noyade des enfants, il est recommandé de sécuriser l'accès à la piscine avec un dispositif de protection!





 Per prevenire l'annegamento dei bambini, si consiglia di proteggere l'accesso alla piscina con un dispositivo di protezione!





 Om verdrinking van kinderen te voorkomen, is het aan te raden om de toegang tot het zwembad te beveiligen met een beschermend apparaat!





 Aby se zabránilo utopení dětí, doporučuje se zajistit přístup k bazénu s ochranným zařízením!



- *  Nicht im Lieferumfang enthalten
-  Not included
-  Non comprises dans la livraison
-  Niet bijgeleverd

-  No forman parte del suministro
-  Non incluso
-  V ceně není zahrnuto
-  Ikke inkluderet

- 1  Länge muss ermittelt und zugesägt werden
-  Length must be determined and sawn
-  La longueur doit être déterminée et sciée
-  De lengte moet worden bepaald en worden gezaagd

-  La longitud debe ser determinada y aserrada
-  La lunghezza deve essere determinata e segata
-  Délka musí být určena a rozřezána
-  Længden skal bestemmes og saves

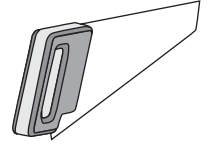
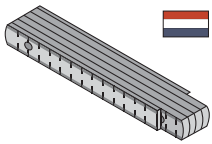



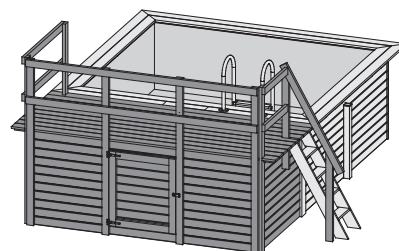

- 2  Nicht gebraucht
-  Not needed
-  Pas nécessaire
-  Niet nodig

-  No es necesario
-  Non necessario
-  Není nutná

3





- 4  Fixiert vorübergehend
-  tijdelijk vast
-  Fixed temporarily
-  temporairement fixe

-  temporalmente fijo
-  temporaneamente fisso
-  dočasně pevný
-  Zčasno pritrjeno

 Vorbereitung
 preparation
 préparation

 voorbereiding
 forberedelse
 preparación

 preparazione
 příprava

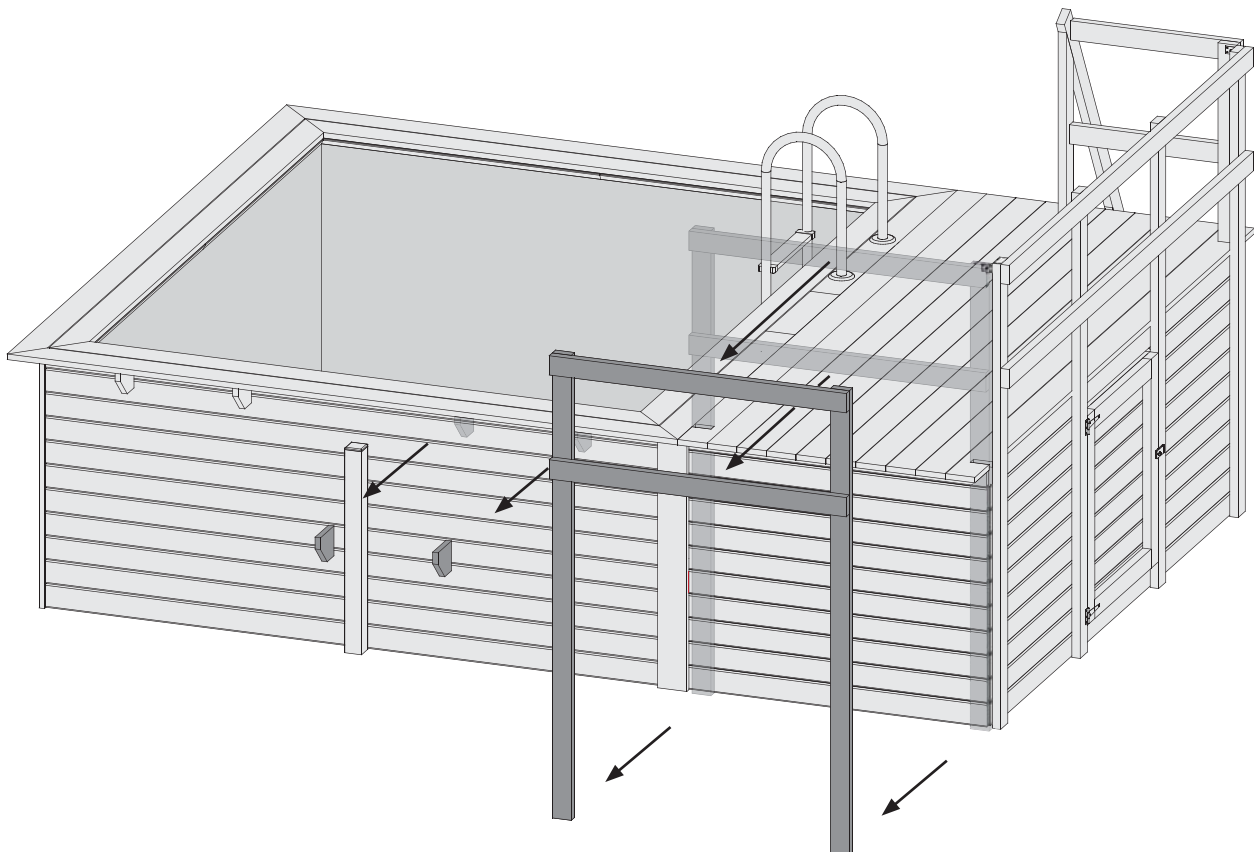
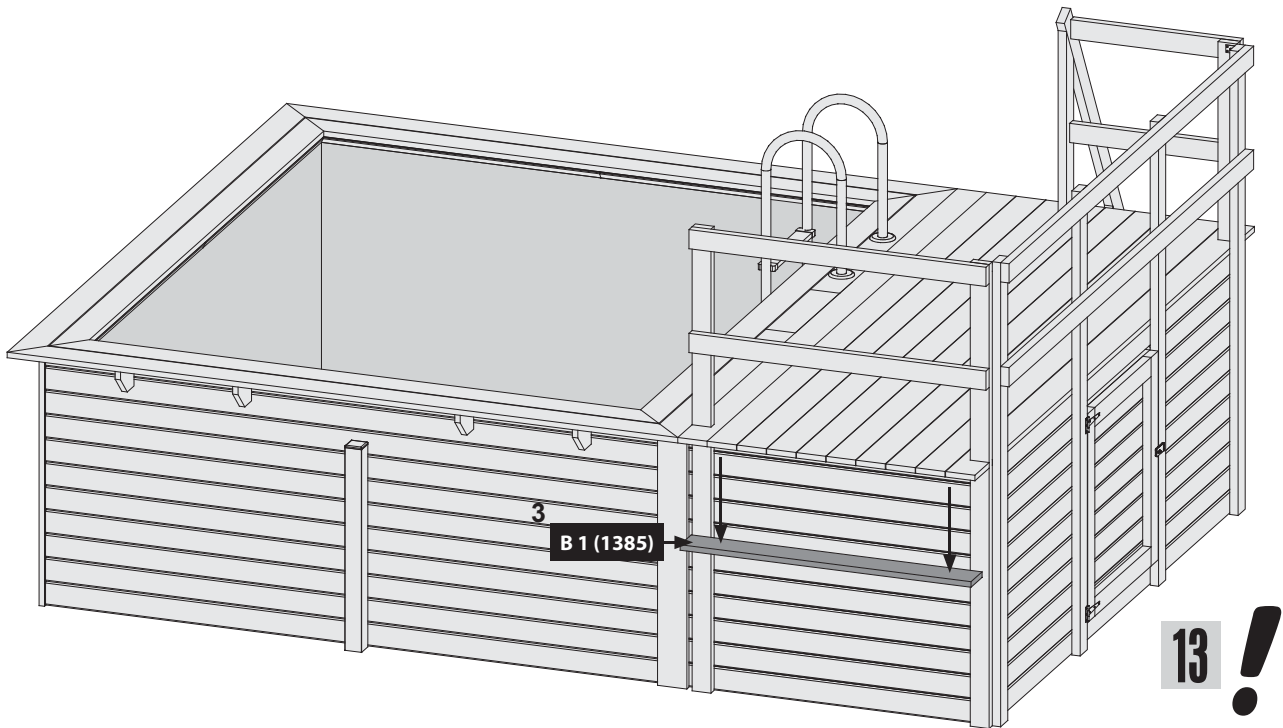

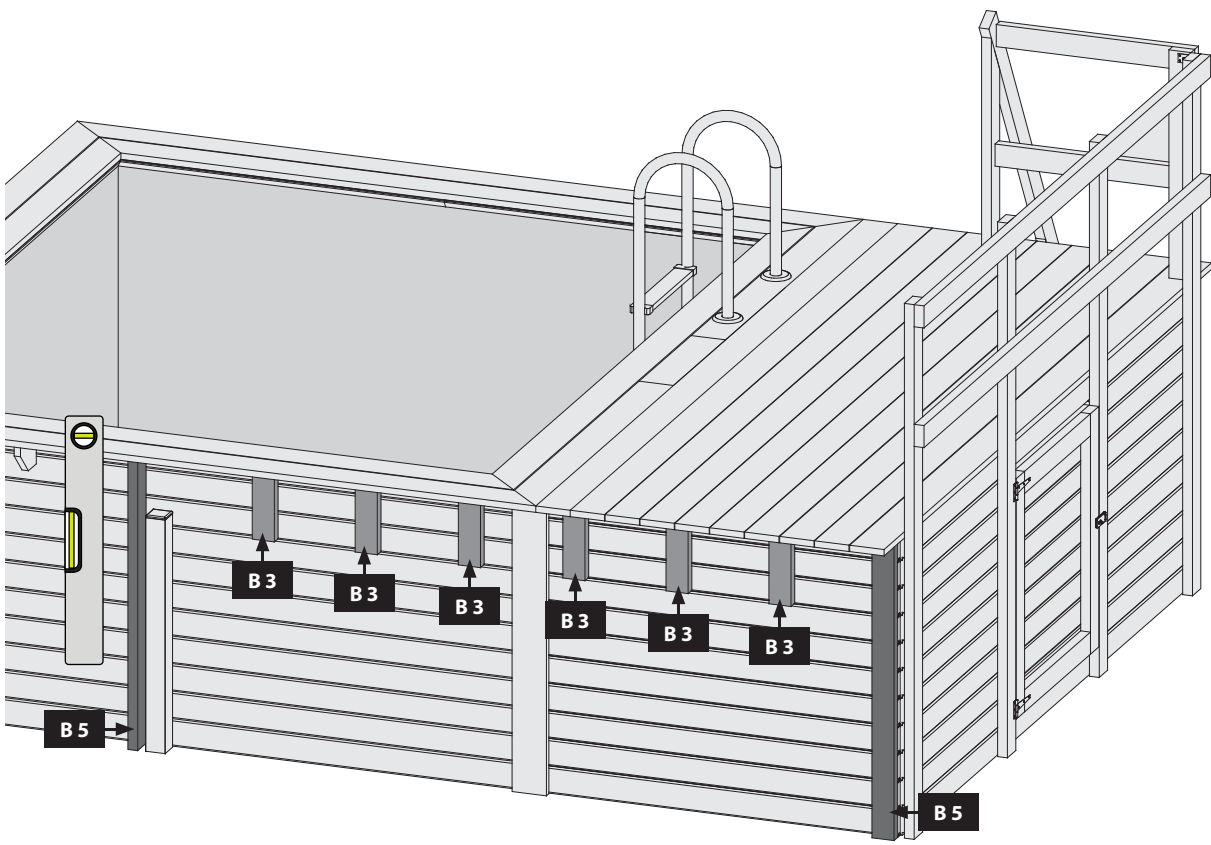

Ø3 mm 4x35

14x

Ø3 mm 4x50

24x

Ø3 mm 4x70

8x

2x

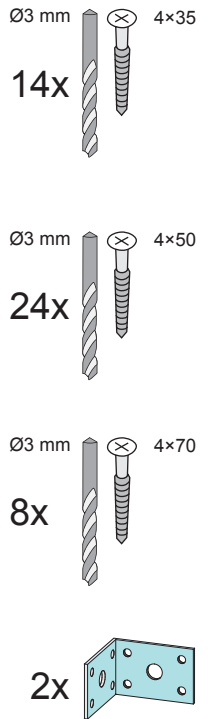

01.1

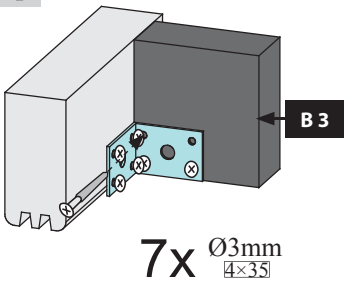

7x Ø3mm 4x35

-  Bündig!
-  Flush!
-  Affleurement!
-  Gelijk!
-  I flugt!
-  Aras!
-  Combacia!
-  Stejný!

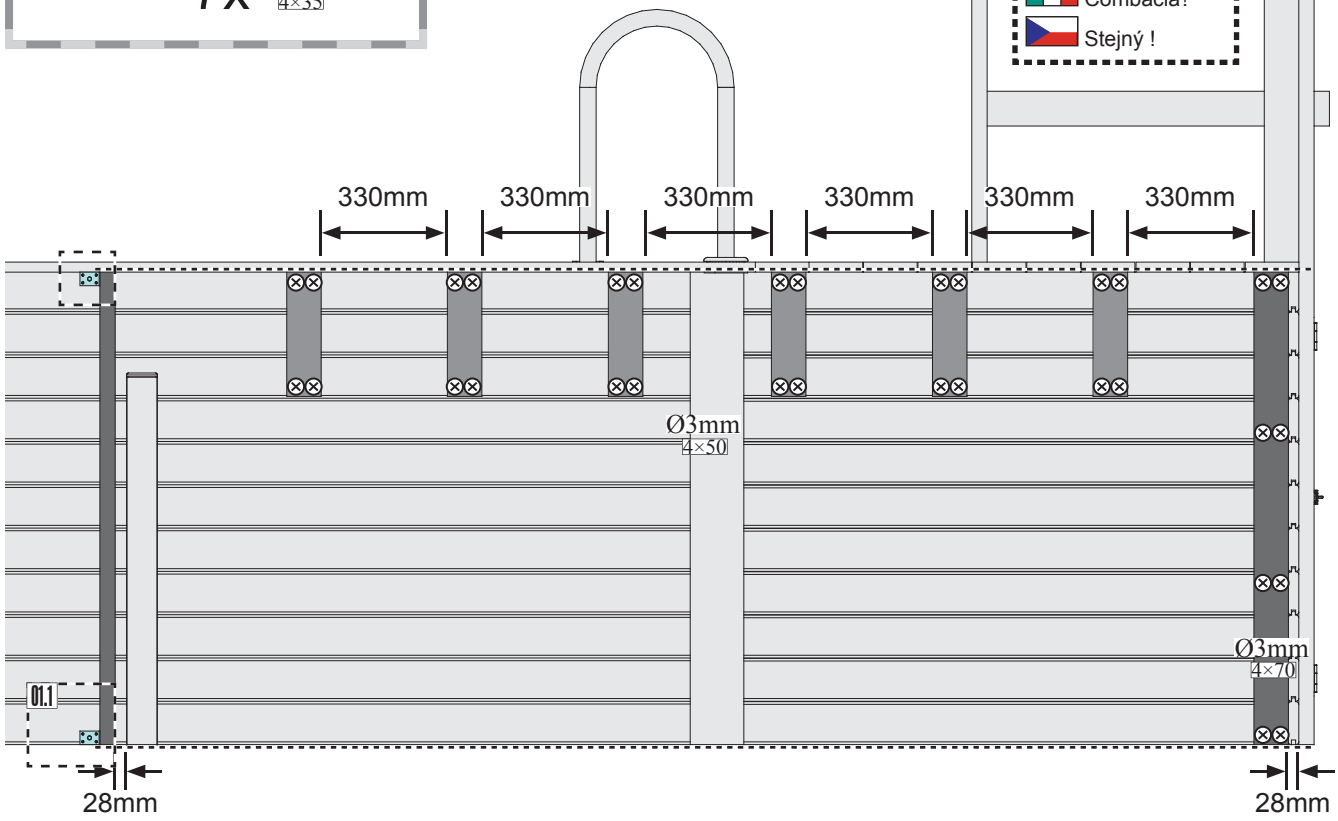

Ø3 mm 4x50
24x

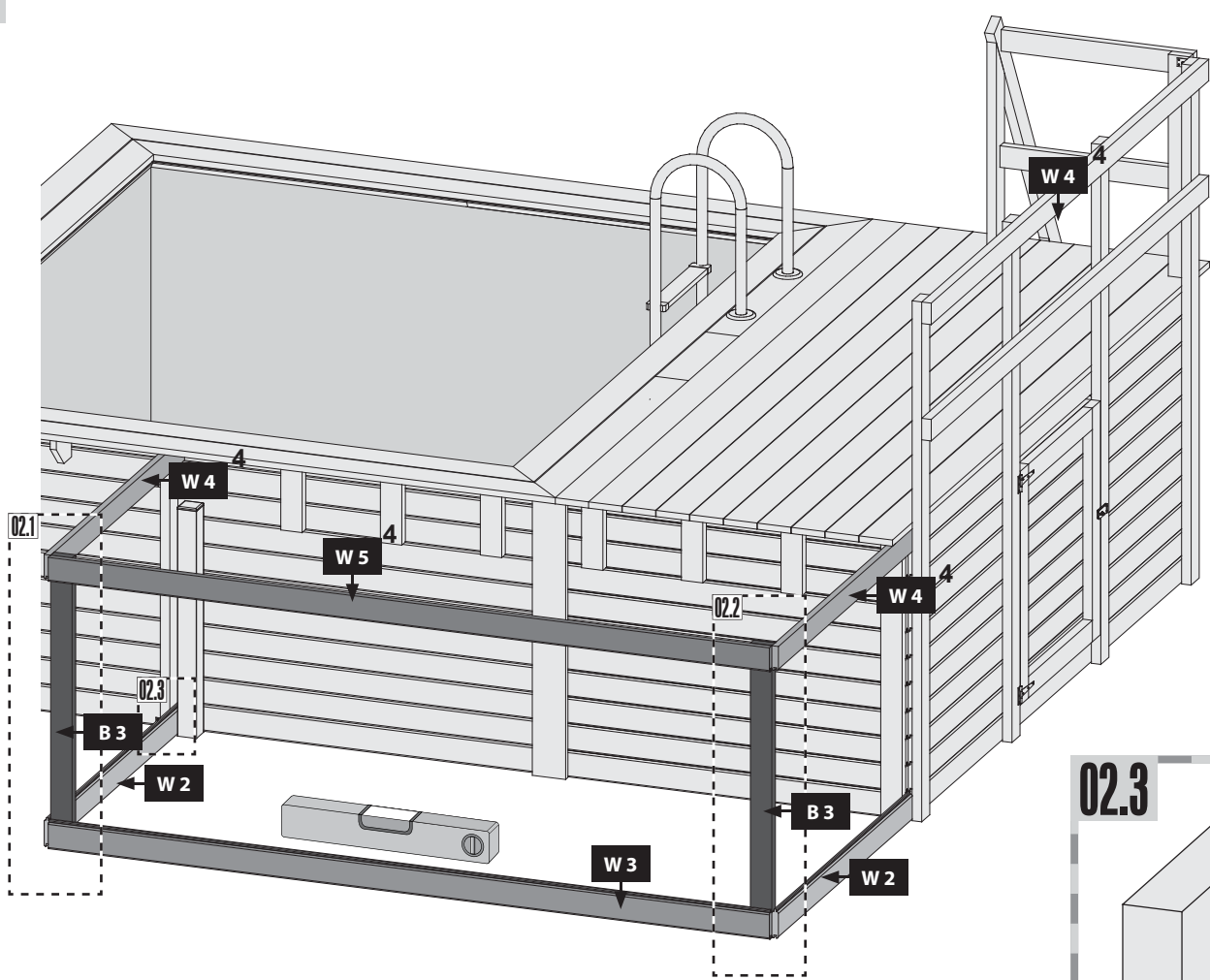

02.3

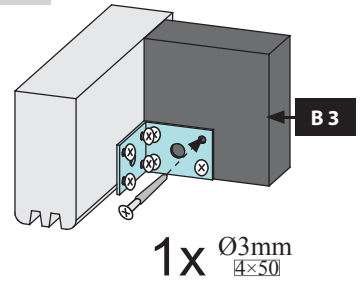

02.1

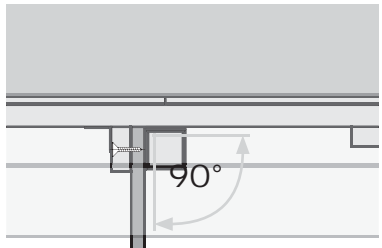





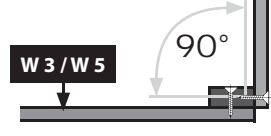
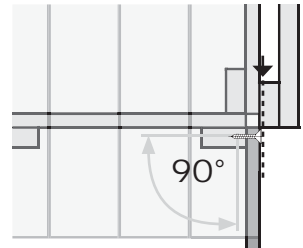

- Bündig!
- Flush!
- Affleurement!
- Gelijk!
- I flugt!
- Aras!
- Combacia!
- Stejný !



- Draufsicht
- Top view
- vue de dessus
- bovenaanzicht
- vista desde arriba
- vista desde arriba
- vista dall'alto
- púdorys

02.2



 Achten Sie auf die gleiche Höhe
 Look for the same height
 Faites attention à la même hauteur

 Besteed aandacht aan de dezelfde hoogte
 Prestar atención a la misma altura
 Prestare attenzione alla stessa altezza

 Dávejte pozor na stejnou výšku
 Pazite na enako višino

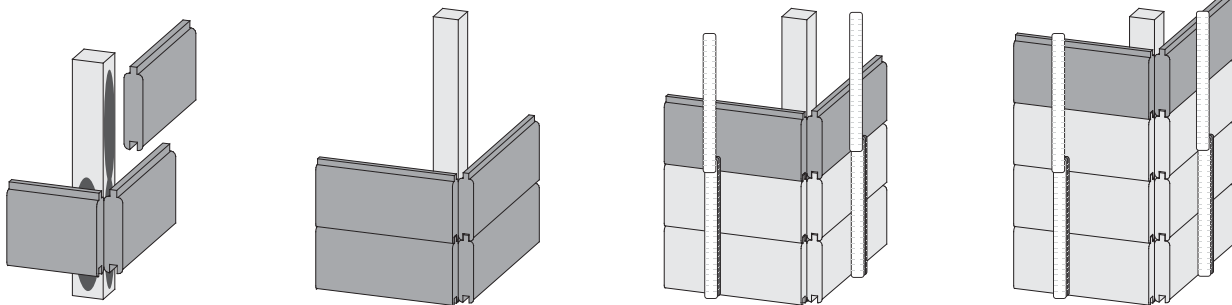

03

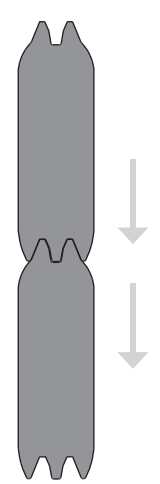
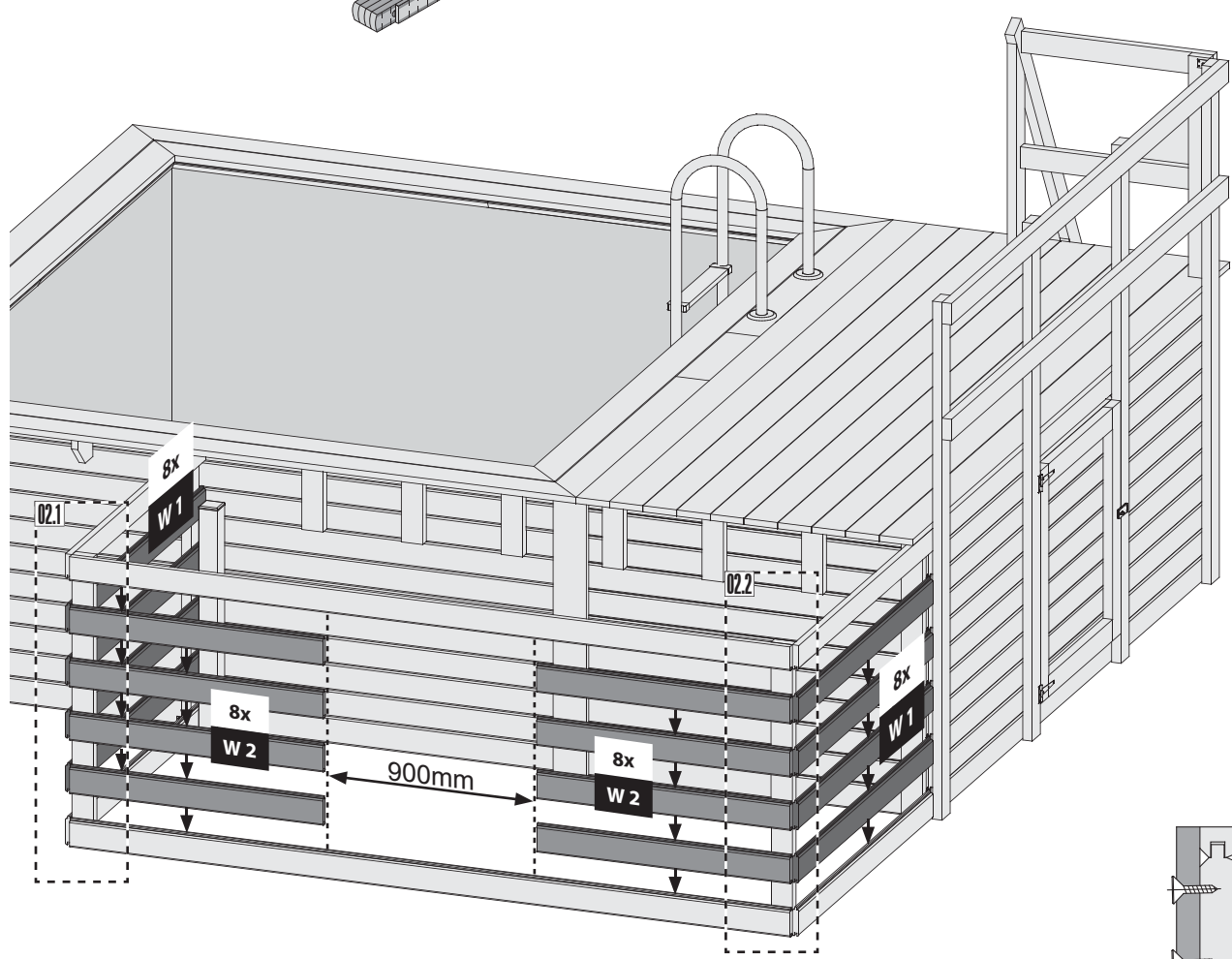
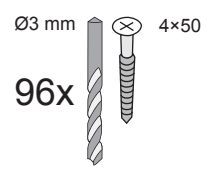
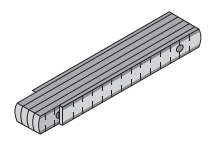

-  Bündig!
-  Flush!
-  Affleurement!
-  Gelijk!
-  I flugt!
-  Aras!
-  Combacia!
-  Stejný!

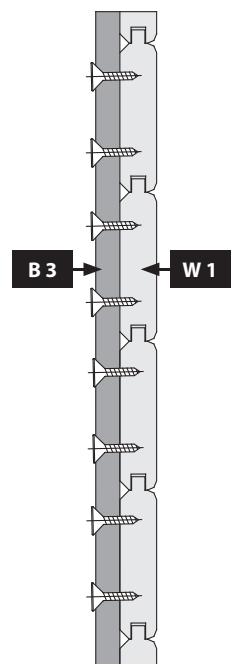

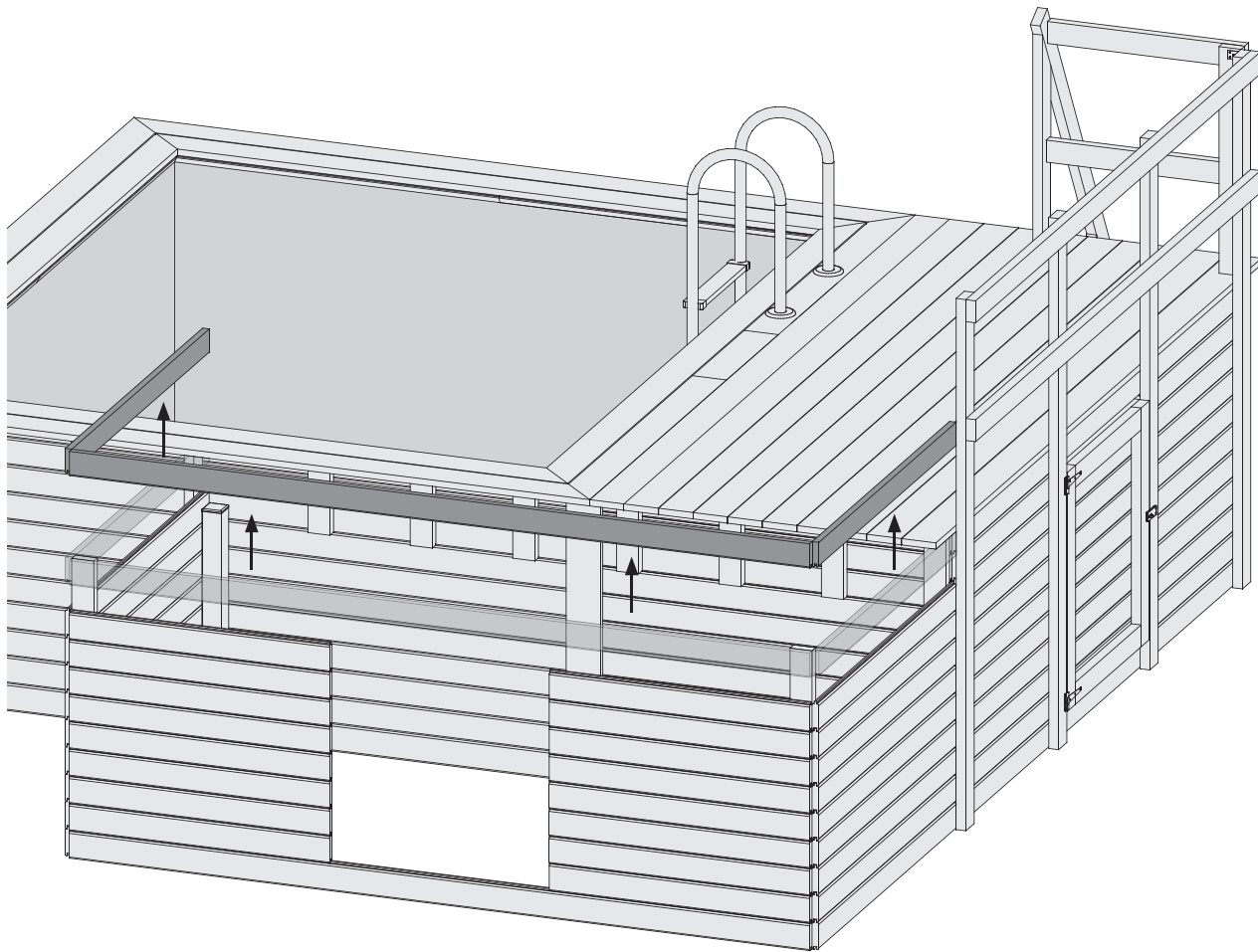

Ø3 mm 4x50

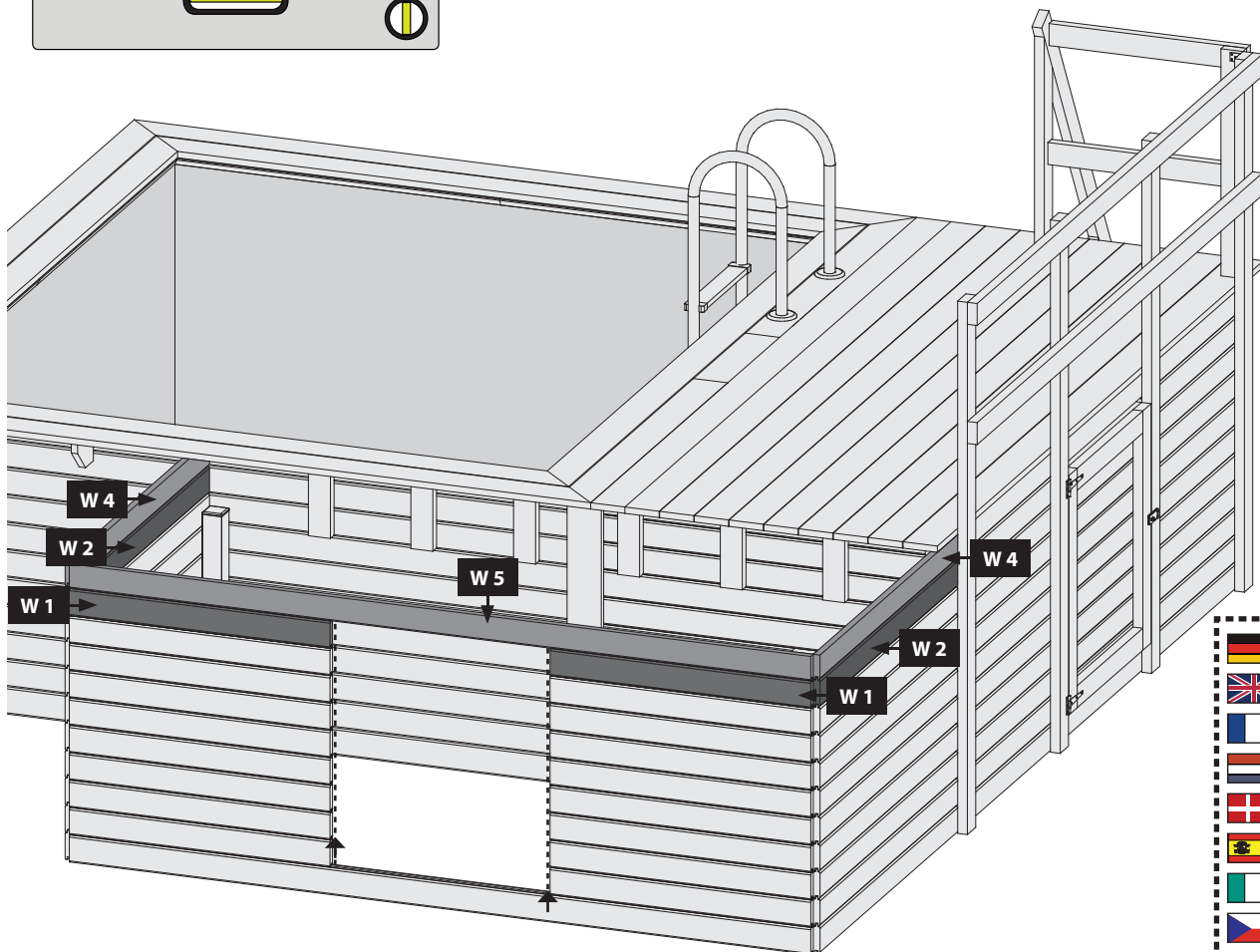

-  Bündig!
-  Flush!
-  Affleurement!
-  Gelijk!
-  I flugt!
-  Aras!
-  Combacia!
-  Stejný !

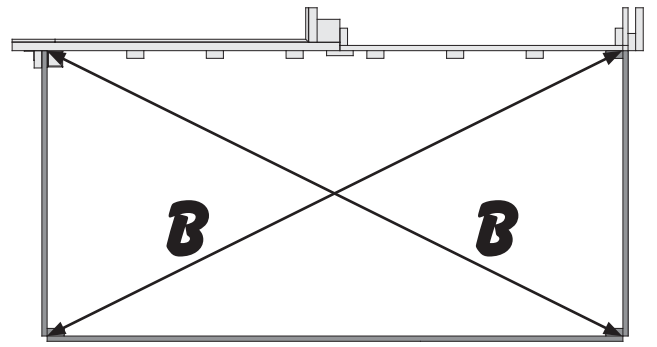
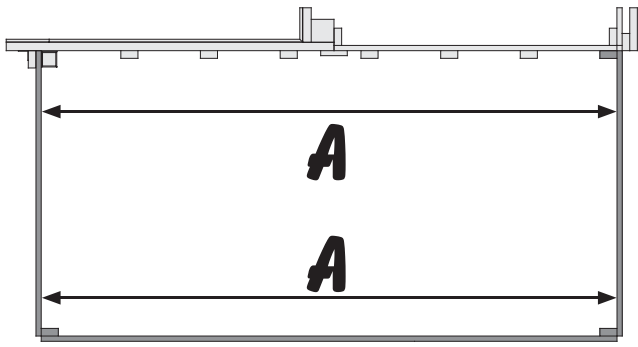

06

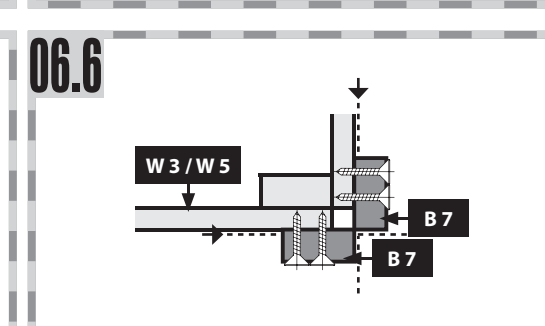
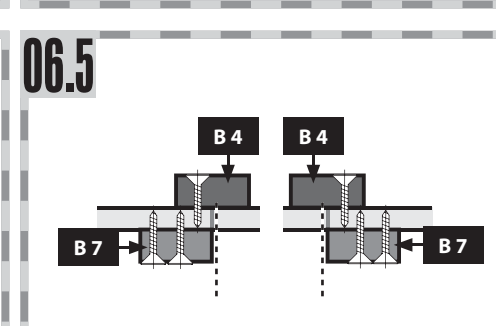
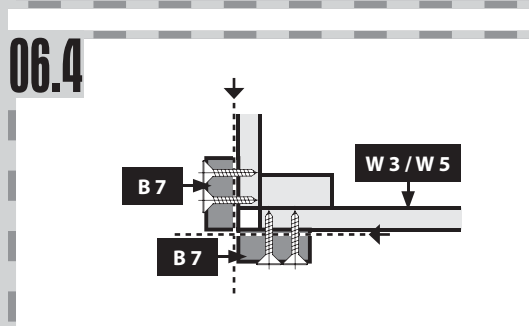
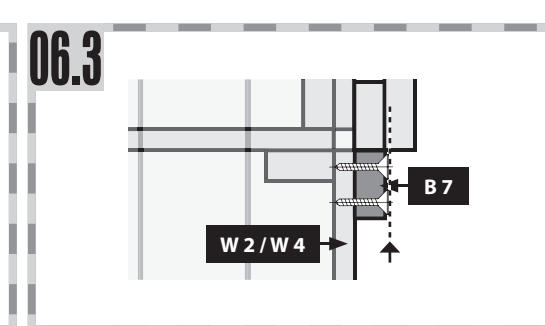
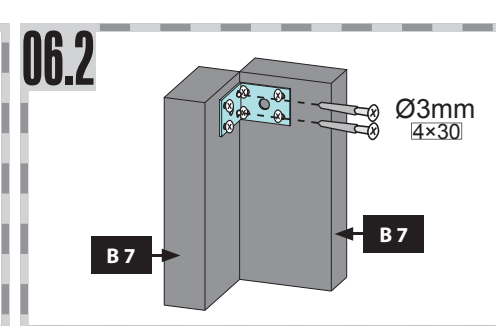
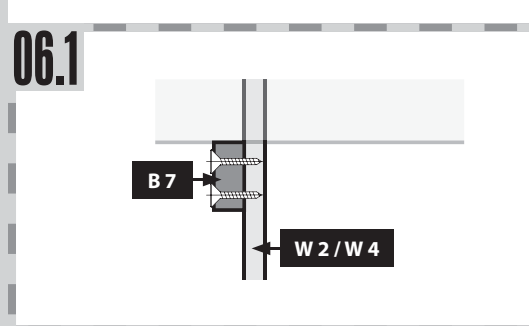
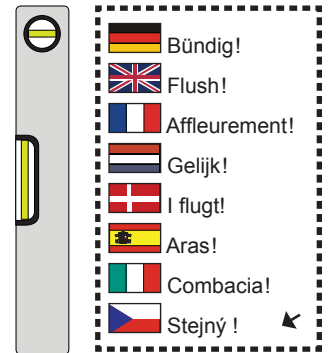
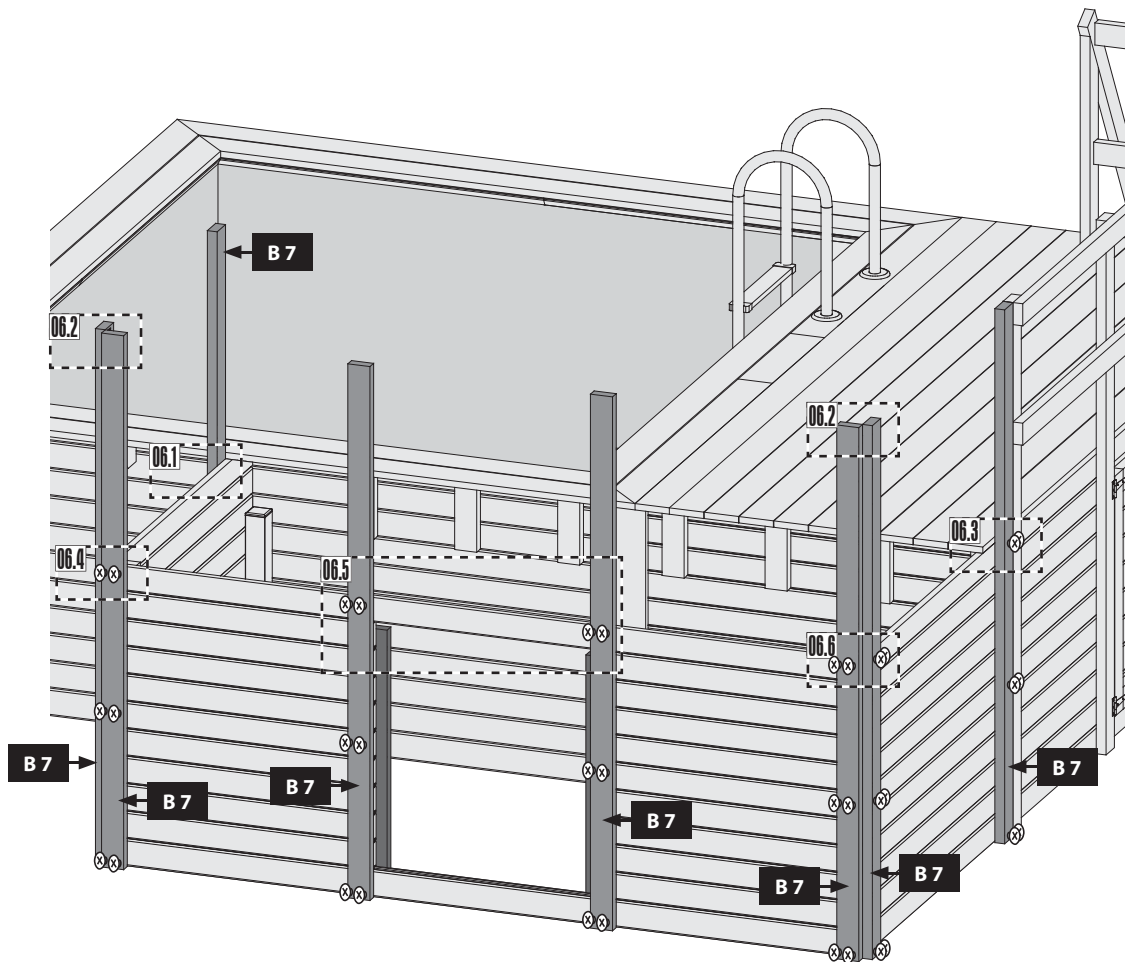
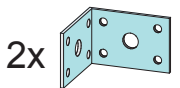
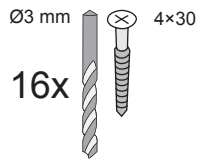
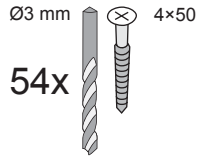

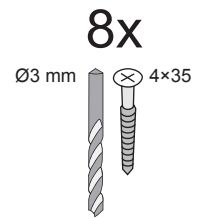
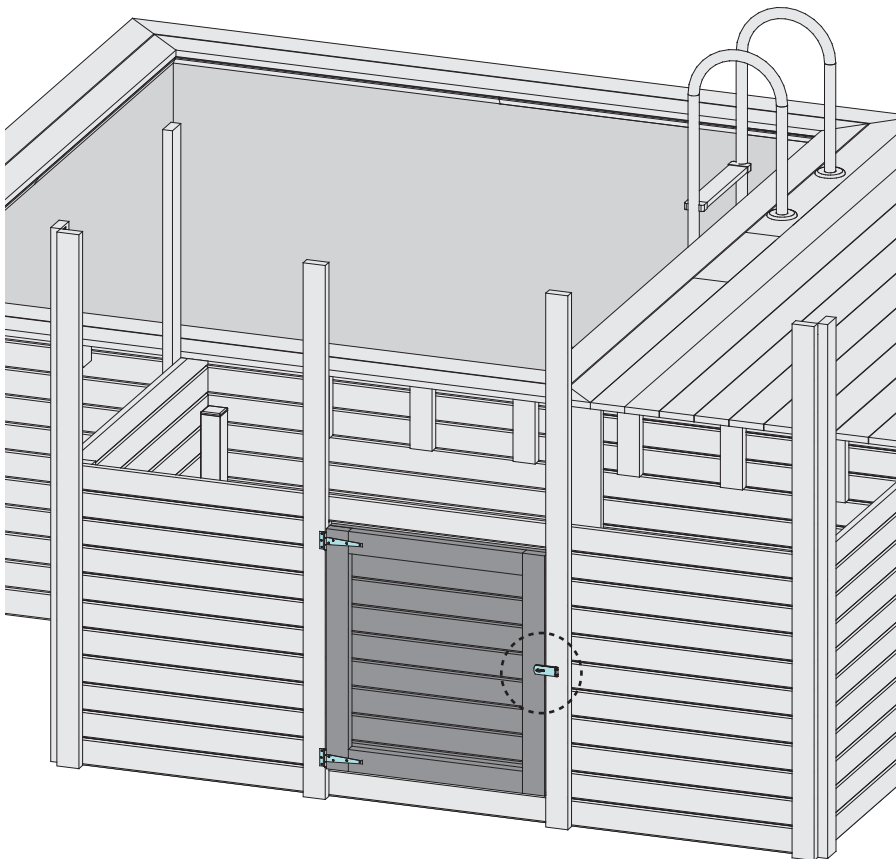
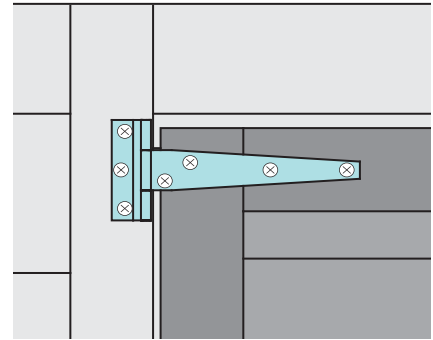
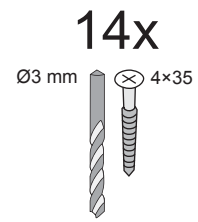
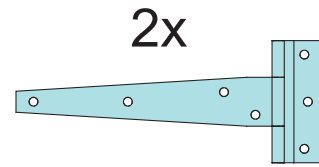
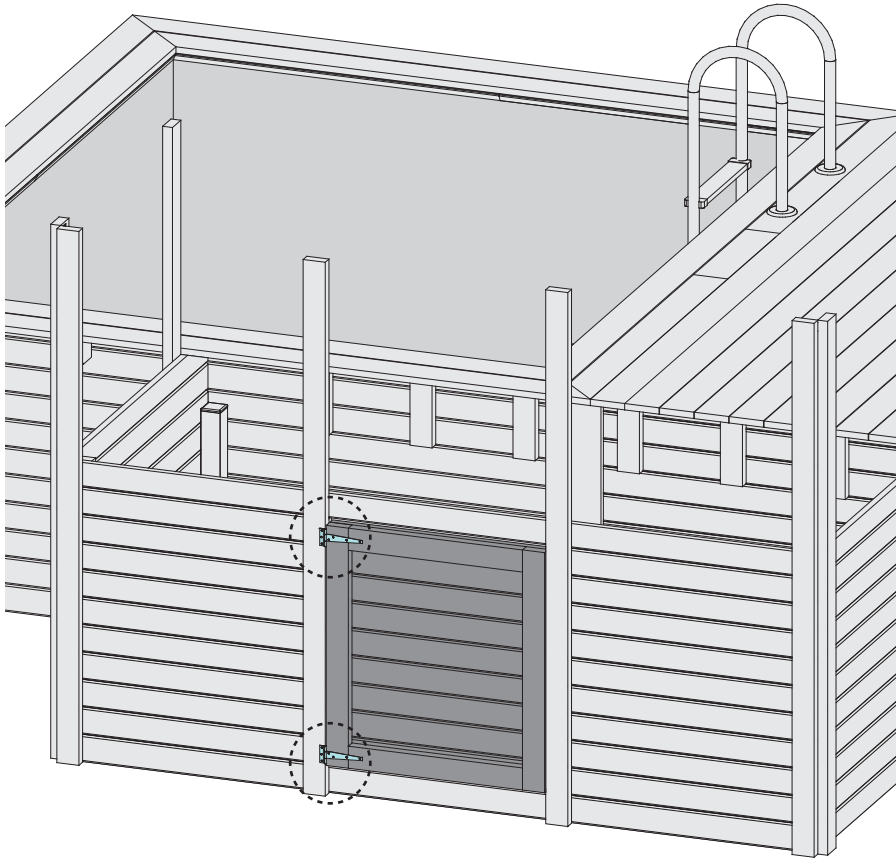

- 1.
- 2.
- 3.

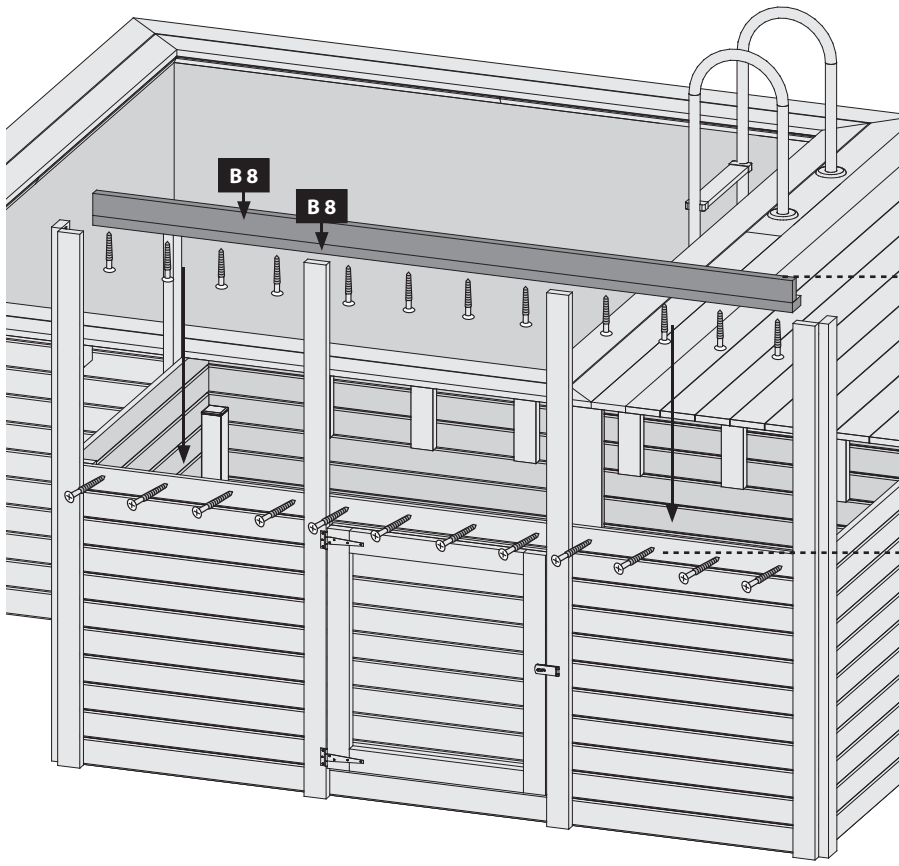

-  Bündig!
-  Flush!
-  Affleurement!
-  Gelijk!
-  I flugt!
-  Aras!
-  Combacia!
-  Stejný!

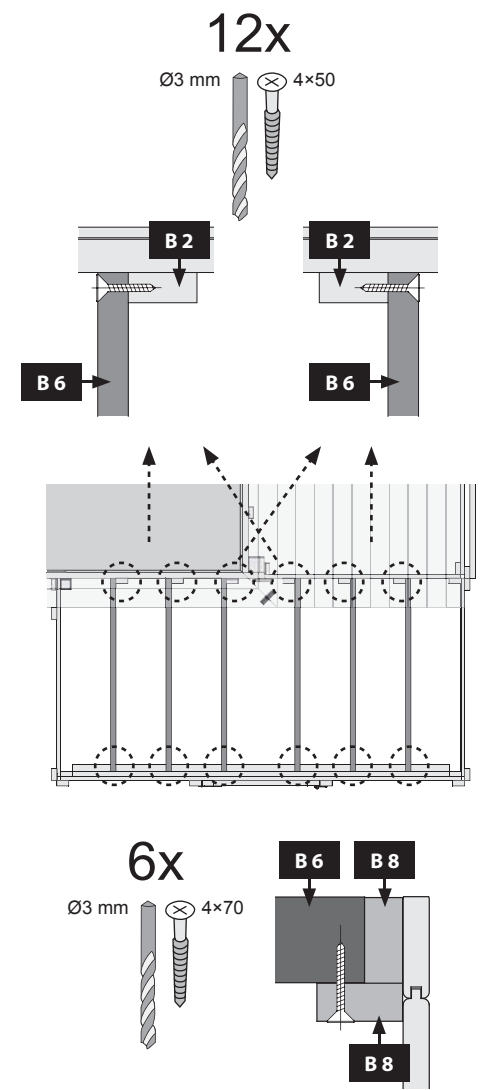
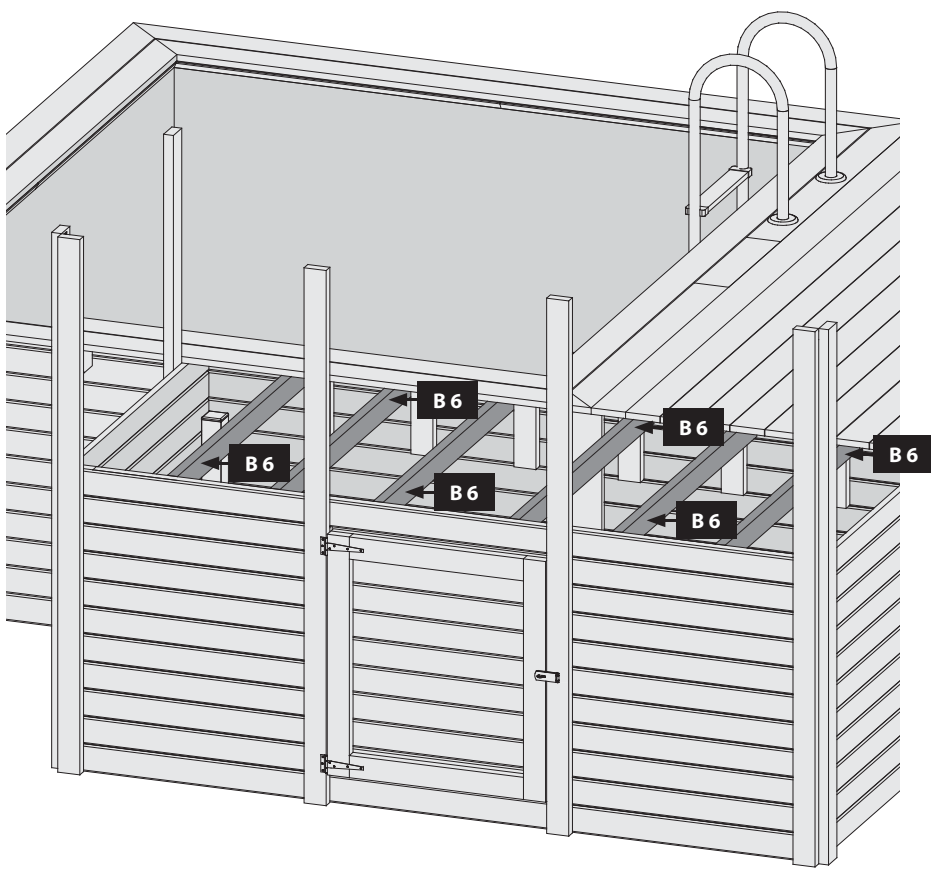
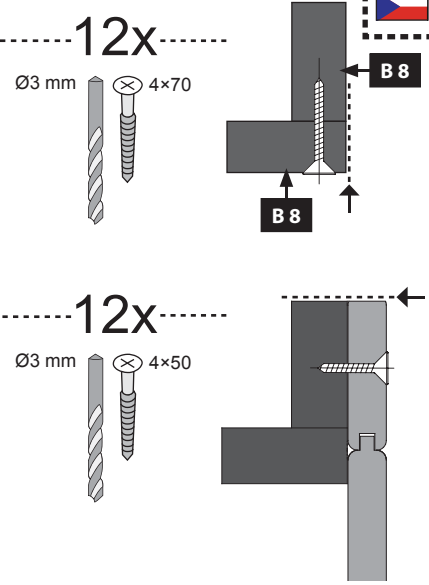

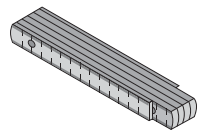

Ø3 mm 4x70

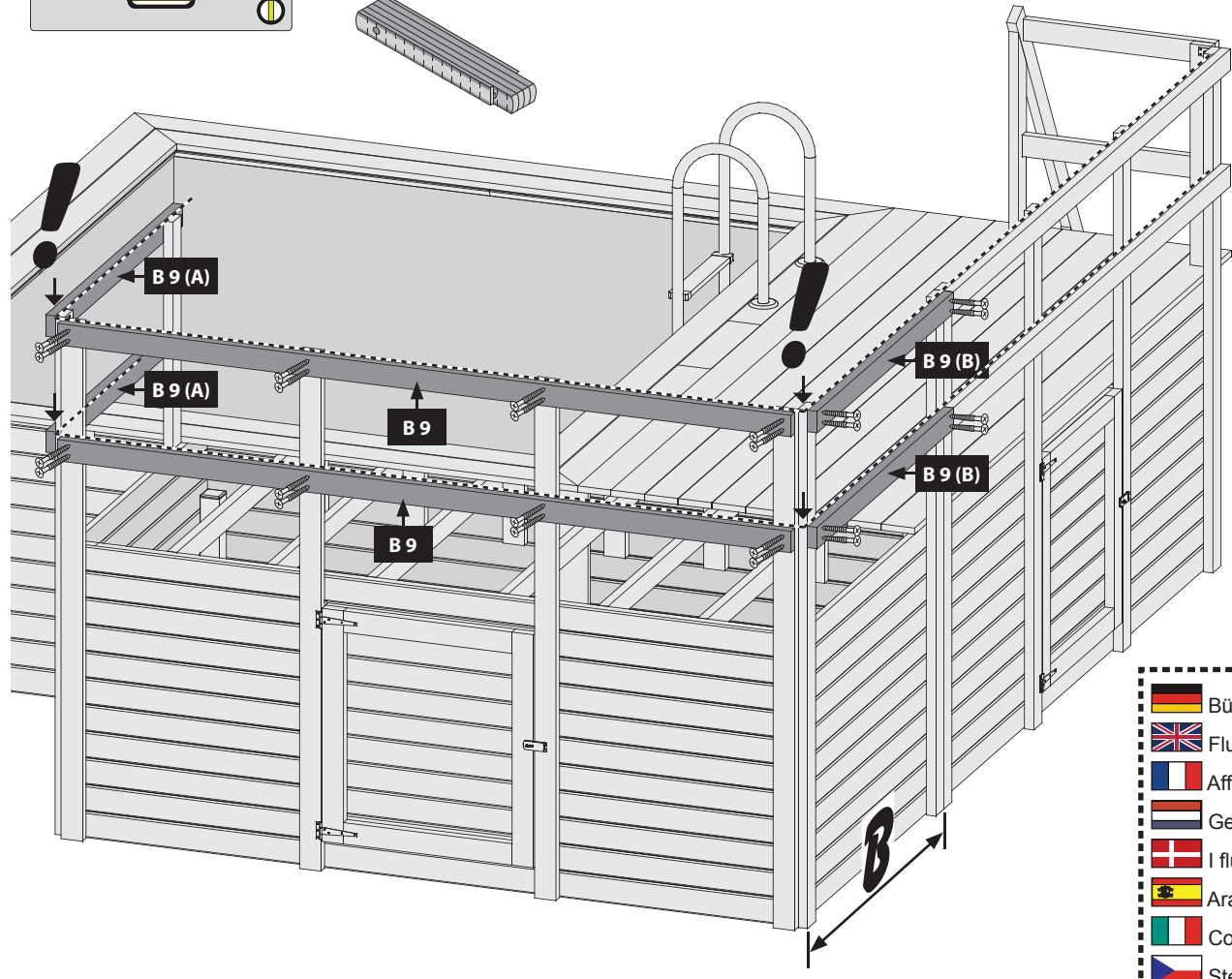
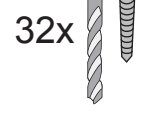

-  Bündig!
-  Flush!
-  Affleurement!
-  Gelijk!
-  I flugt!
-  Aras! ←
-  Combacia!
-  Stejný!

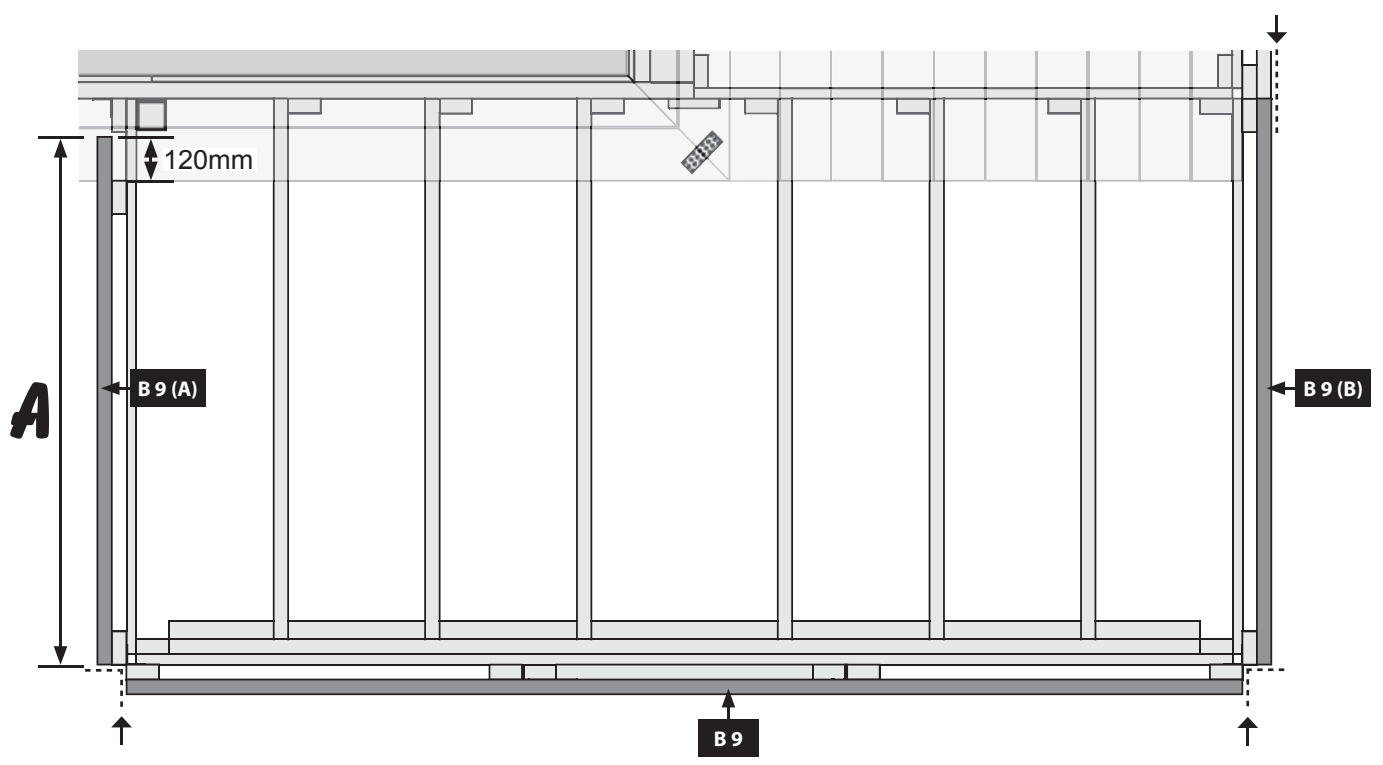
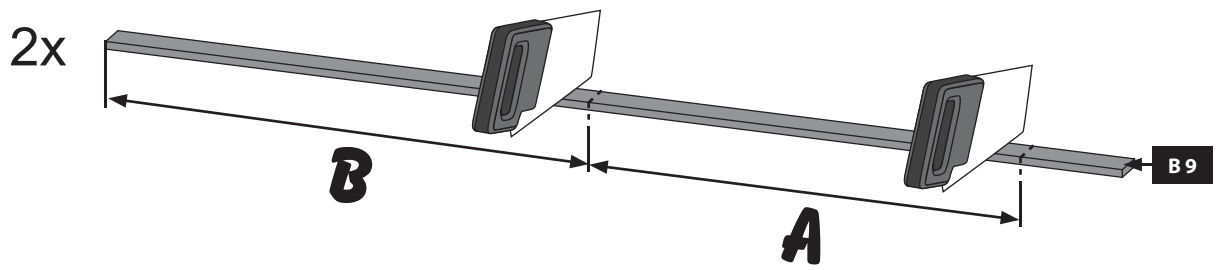

144x

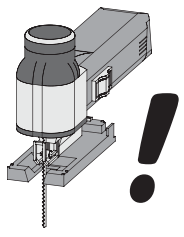
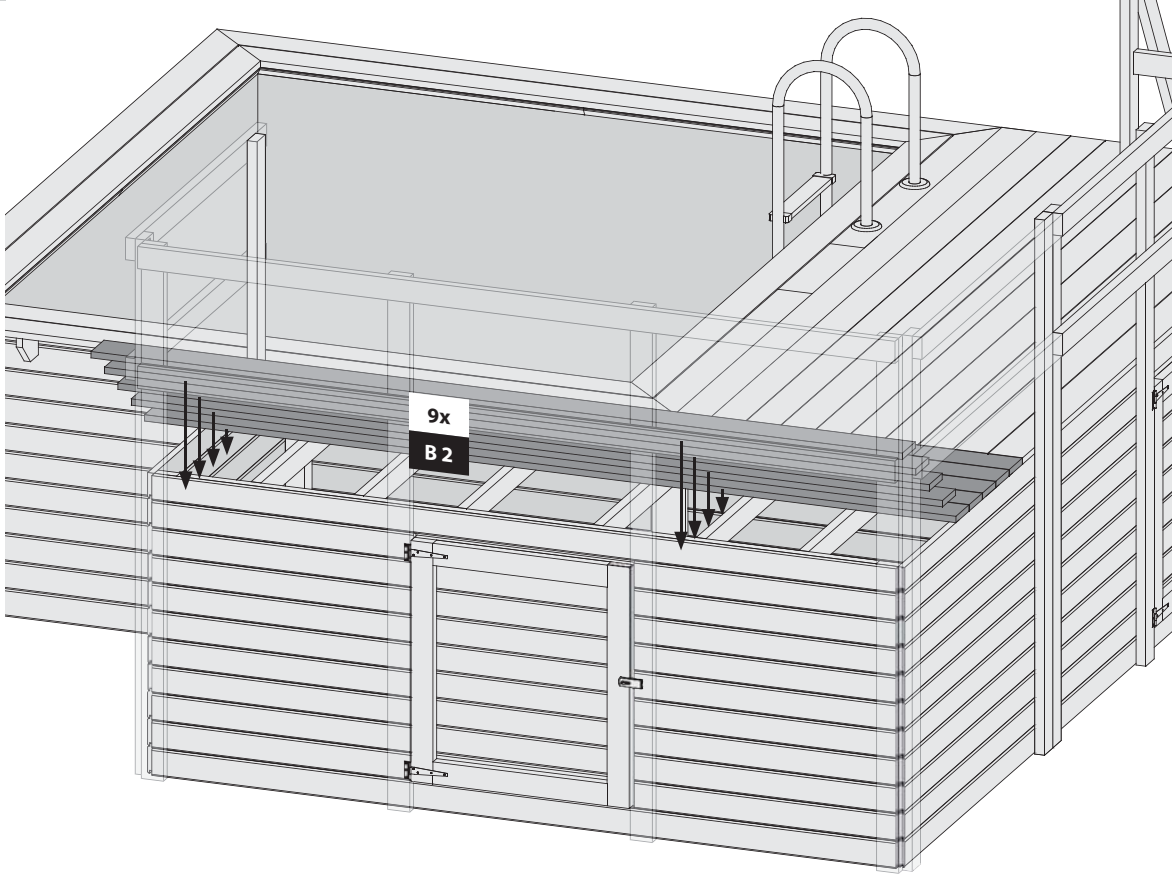
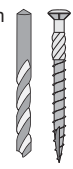

-  Bündig!
-  Flush!
-  Affleurement!
-  Gelijk!
-  I flugt!
-  Aras!
-  Combacia!
-  Stejný !

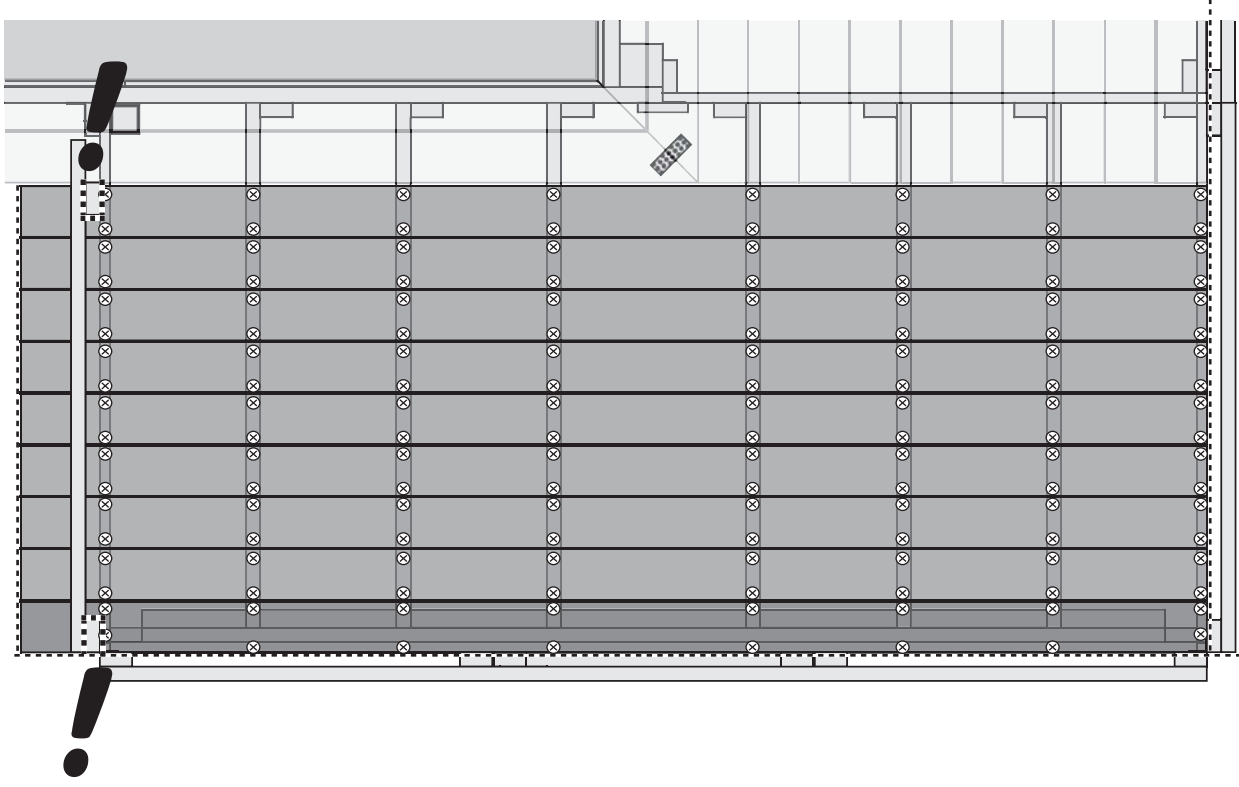
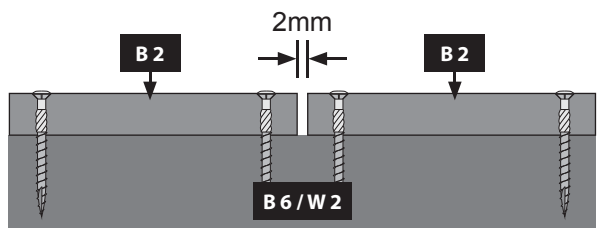

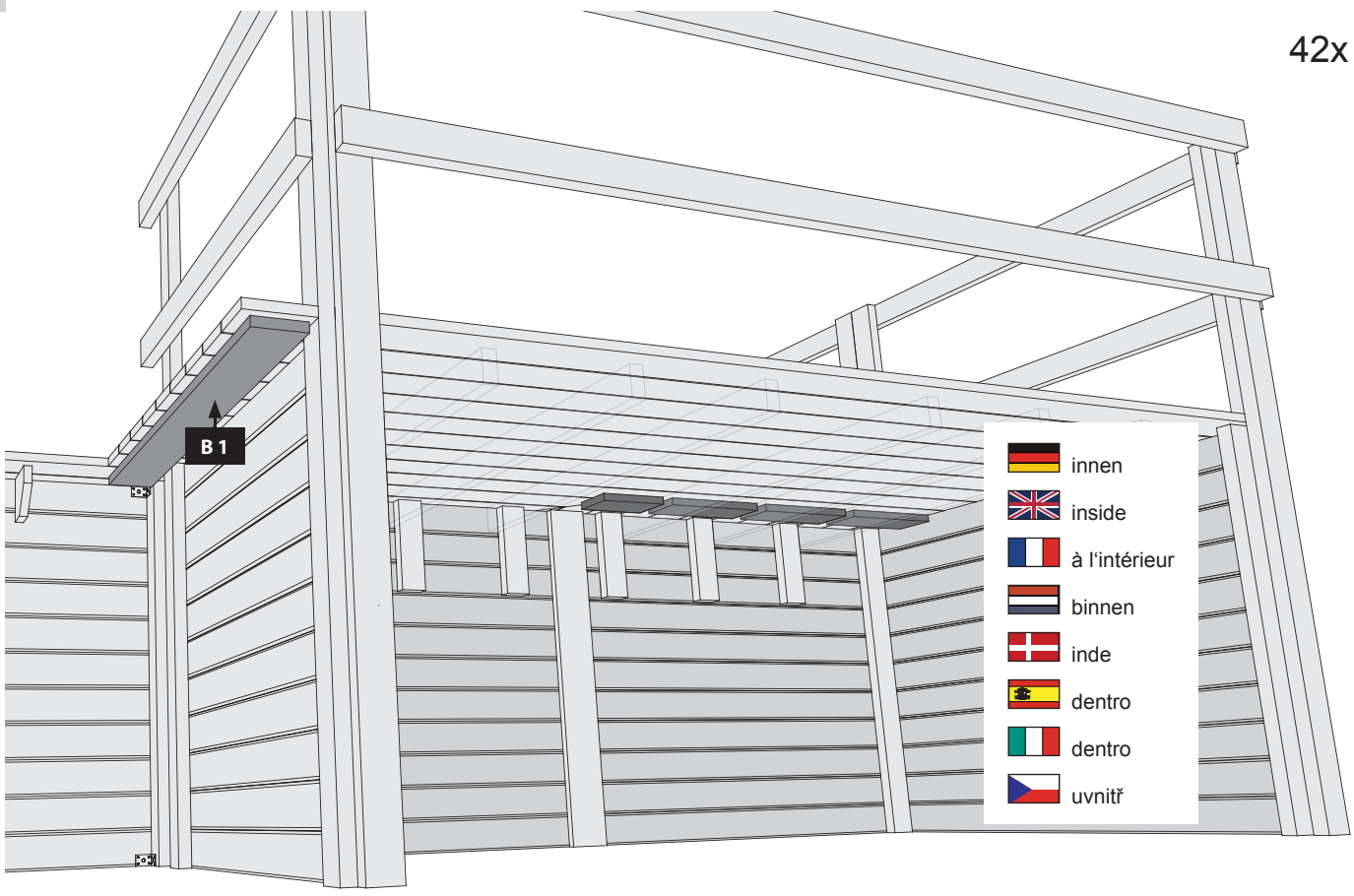

-  innen
-  inside
-  à l'intérieur
-  binnen
-  inde
-  dentro
-  dentro
-  uvnitř

