

(D) Montageanleitung

(FR) Notice de montage

(NL) Handleiding voor de montage

(CZ) Montážní návod

(HU) Szerelési útmutató

(TR) Montaj talimatı

(GB) Assembly instructions

(IT) Istruzioni di montaggio

(PL) Instrukcja montażu

(SK) Návod na montáž

(RO) Instrucțiuni de montare

(RU) инструкции по монтажу

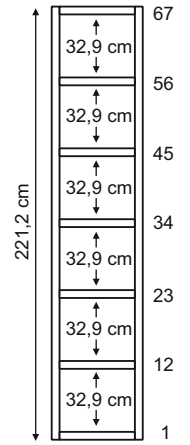
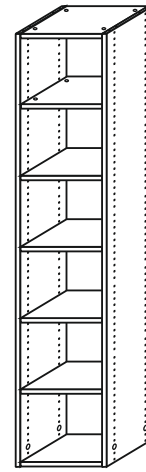

0104291 - 14 / E.N. - 16.08.19

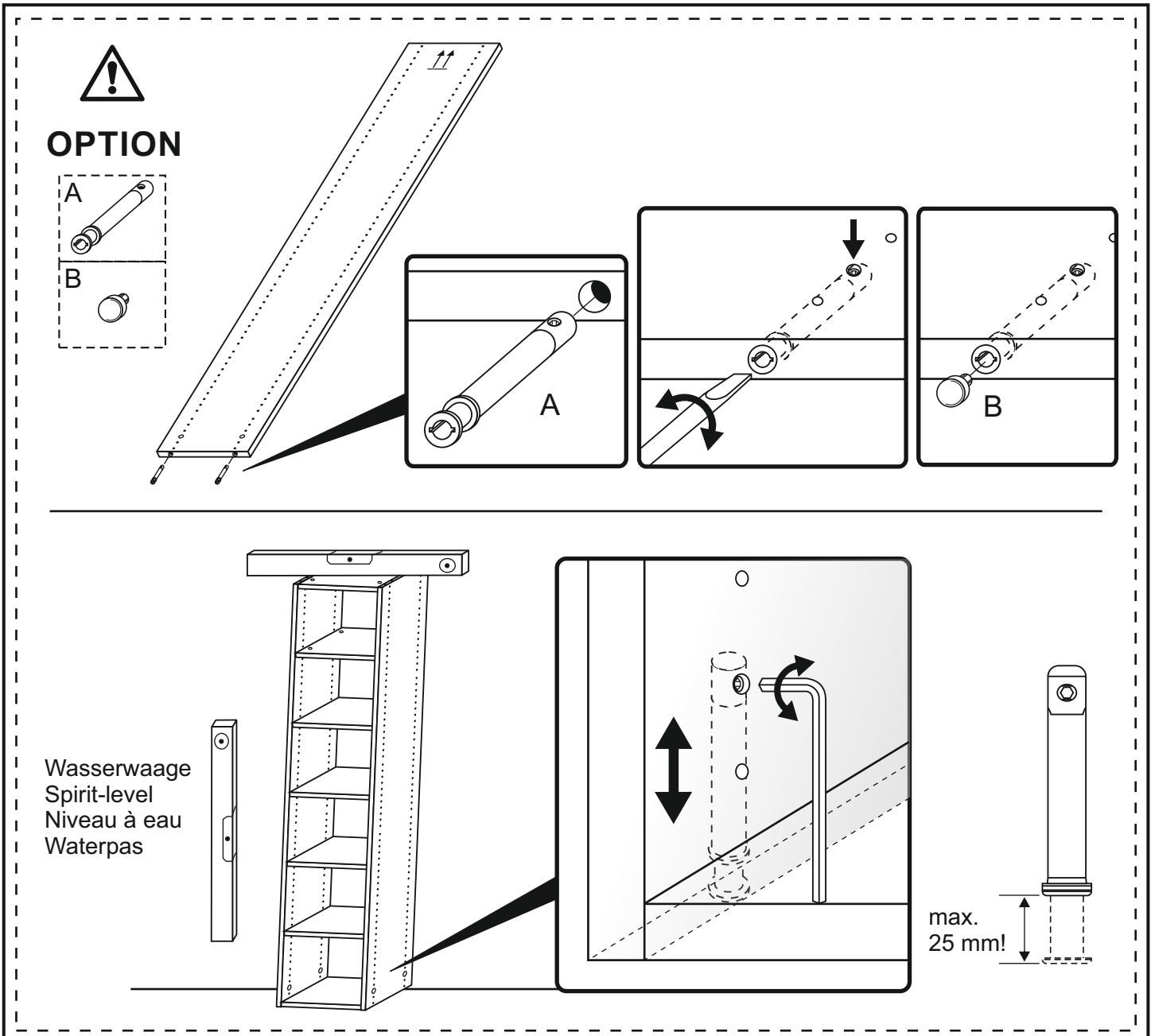
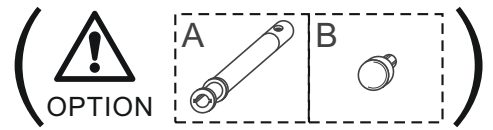
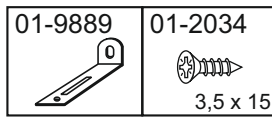
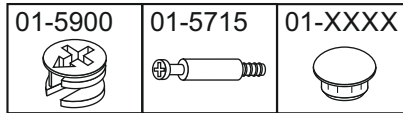
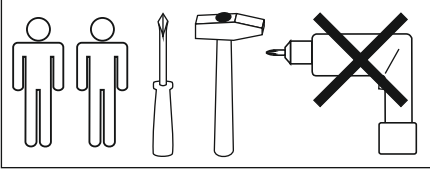

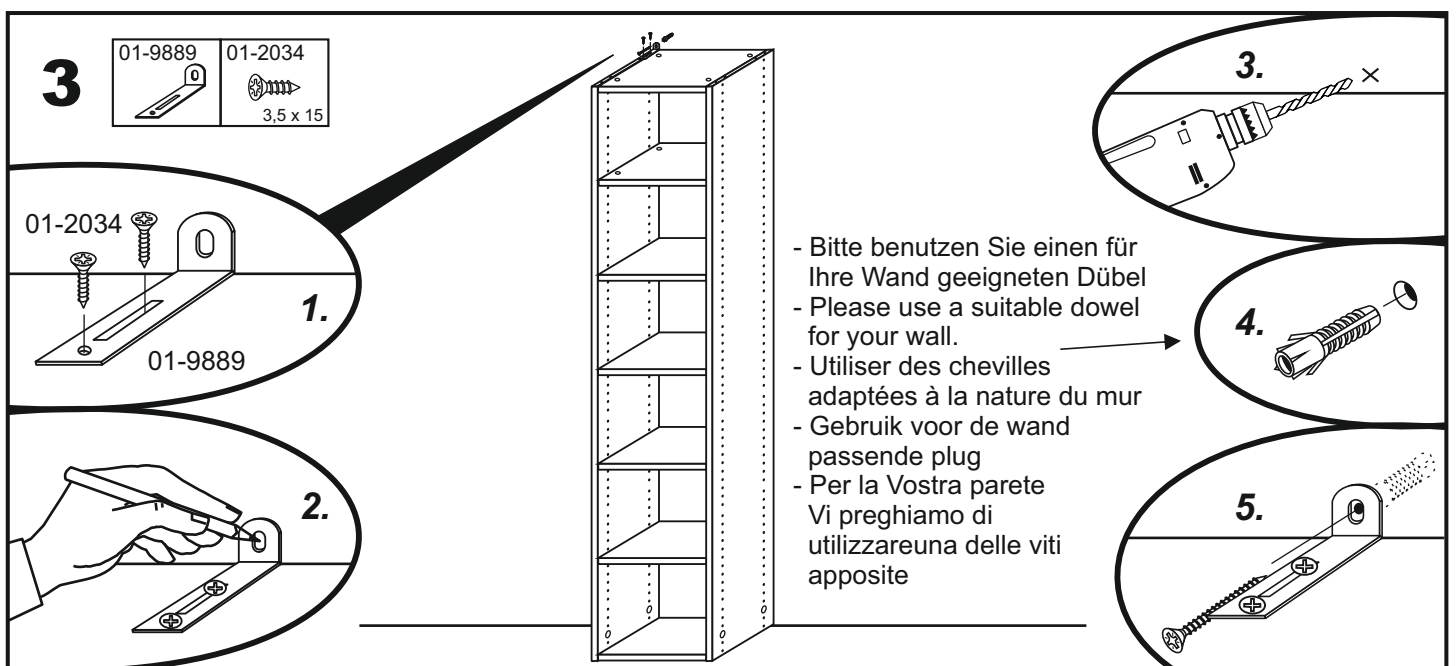
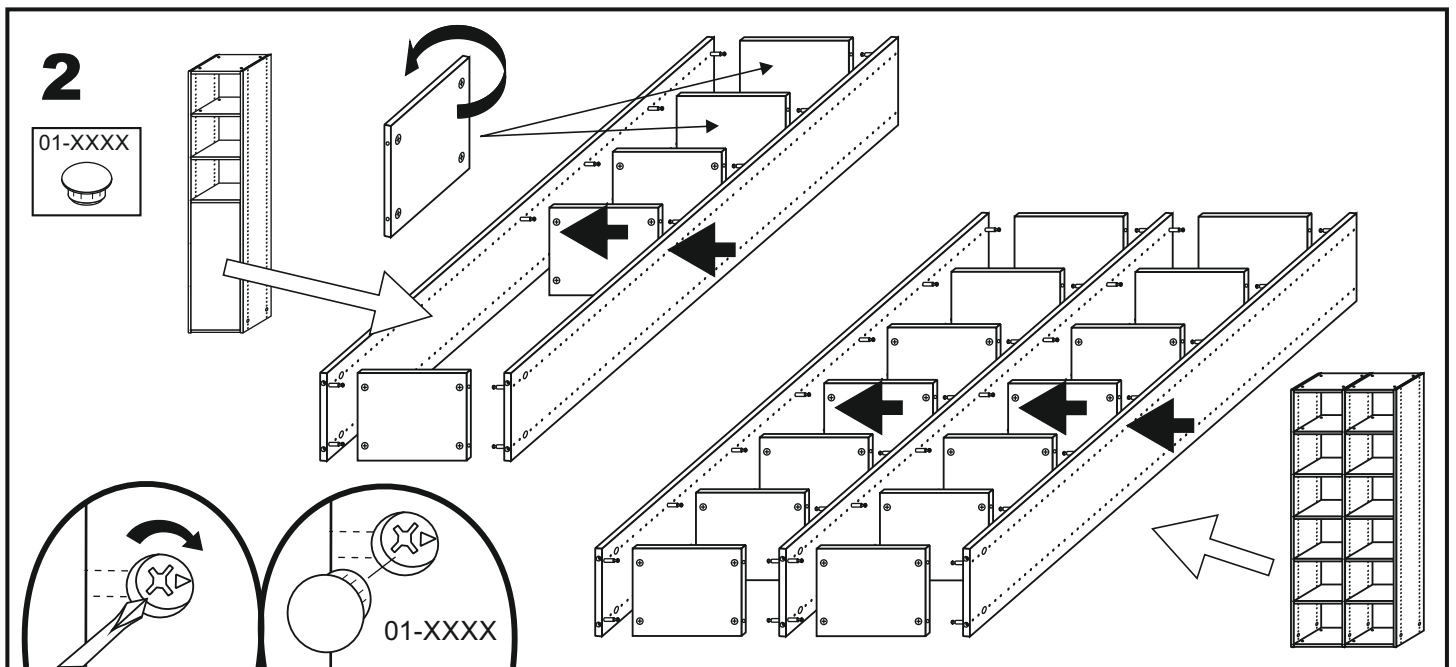
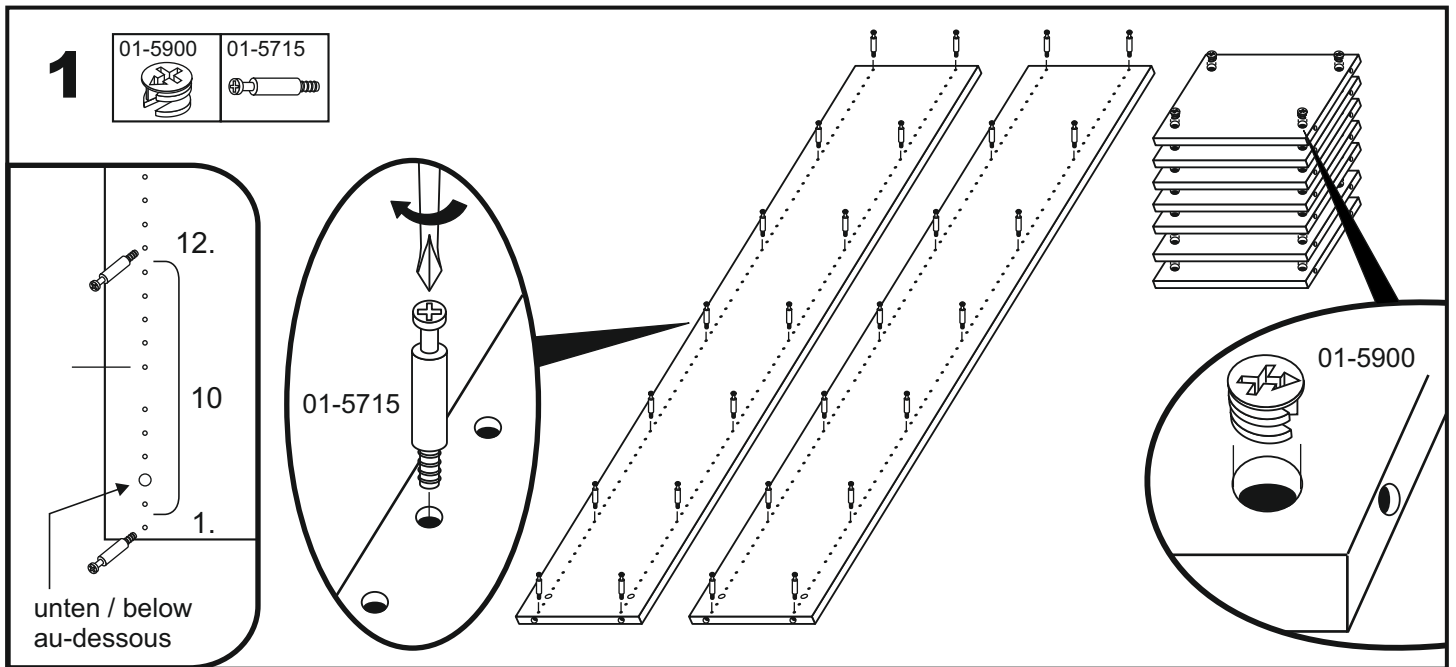

# SCHUBKÄSTEN

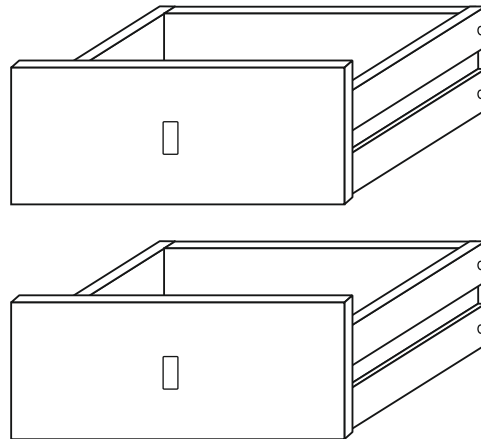

- |   |                                     |
|---|-------------------------------------|
| <b>(D)</b> Montageanleitung             | <b>(GB)</b> Assembly instructions   |
| <b>(FR)</b> Notice de montage           | <b>(IT)</b> Istruzioni di montaggio |
| <b>(NL)</b> Handleiding voor de montage | <b>(PL)</b> Instrukcja montażu      |
| <b>(CZ)</b> Montážní návod              | <b>(SK)</b> Návod na montáž         |
| <b>(HU)</b> Szerelési útmutató          | <b>(RO)</b> Instrucțiuni de montare |
| <b>(TR)</b> Montaj talimati             | <b>(RU)</b> инструкции по монтажу   |

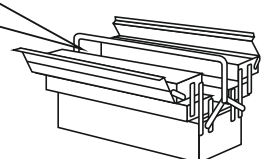
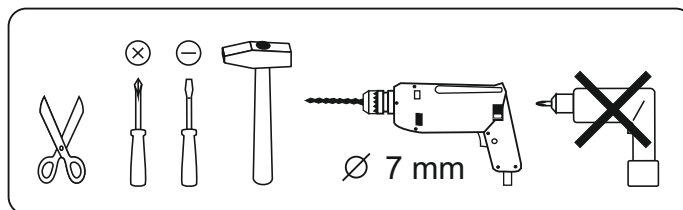
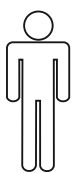

0 mm  
10  
20  
30  
40  
50  
60  
70  
80  
90  
100  
110  
120  
130  
140  
150  
160  
170  
180  
190  
200

Service - Assistenza - Dienstverlening - Serwis Servis Szerviz - Servicii - статистическая служба		
Name • Nom • Nome • Naam Nazwa • Jméno • Názov • Név Denumire • Isim • название		
Nr. • No. • N° • номеро • Č • Sz		
Тур • Туре • Тір • Тípus • Тиро • тип		

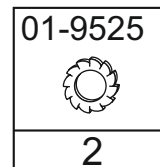
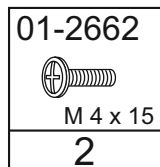
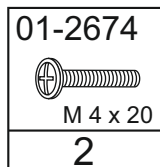
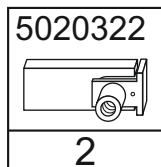
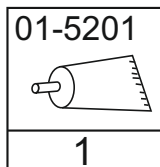
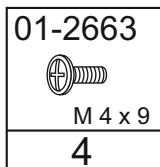
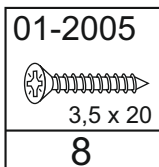
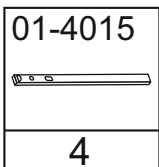
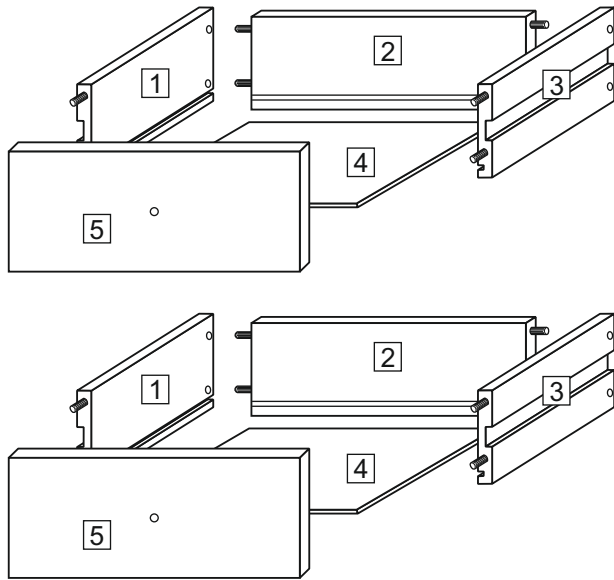
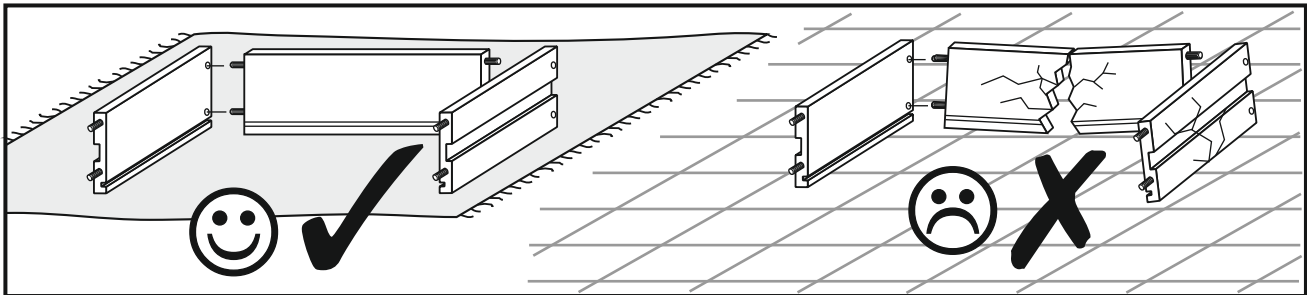

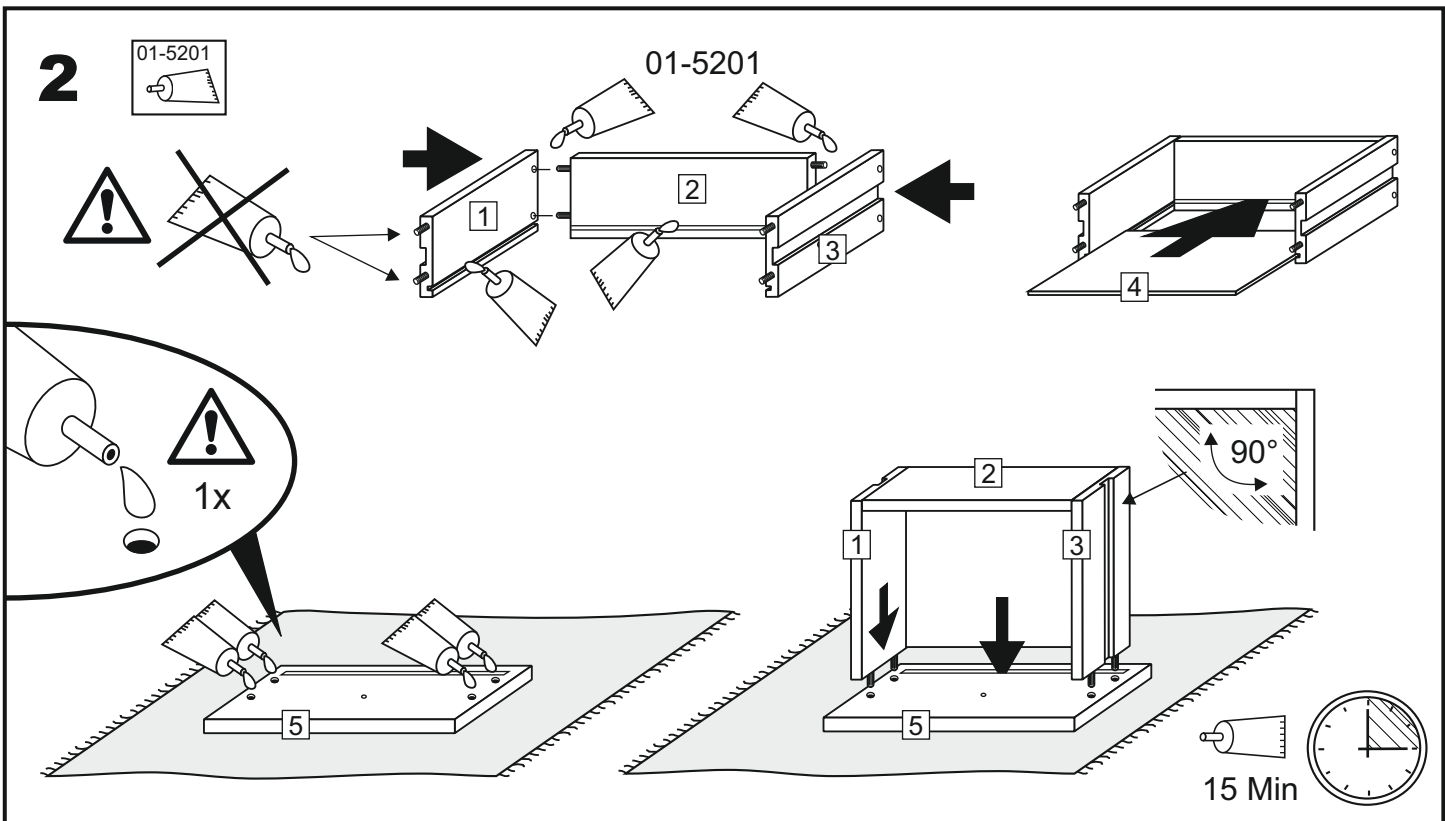
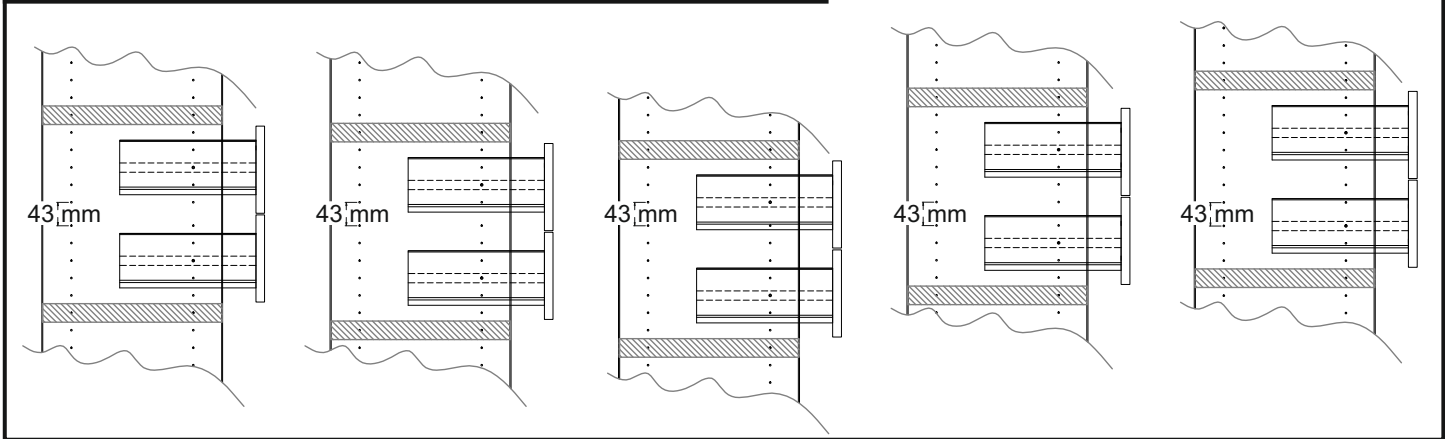
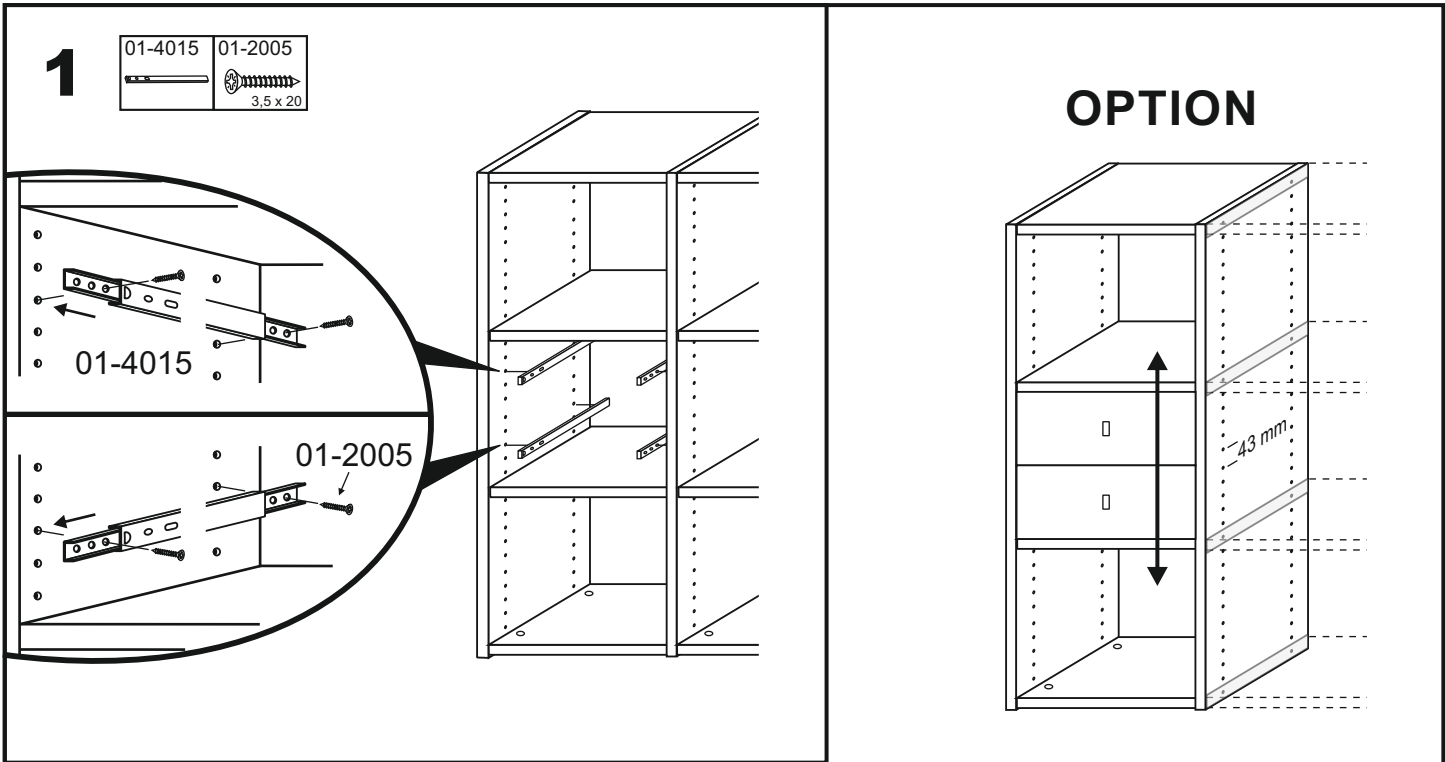

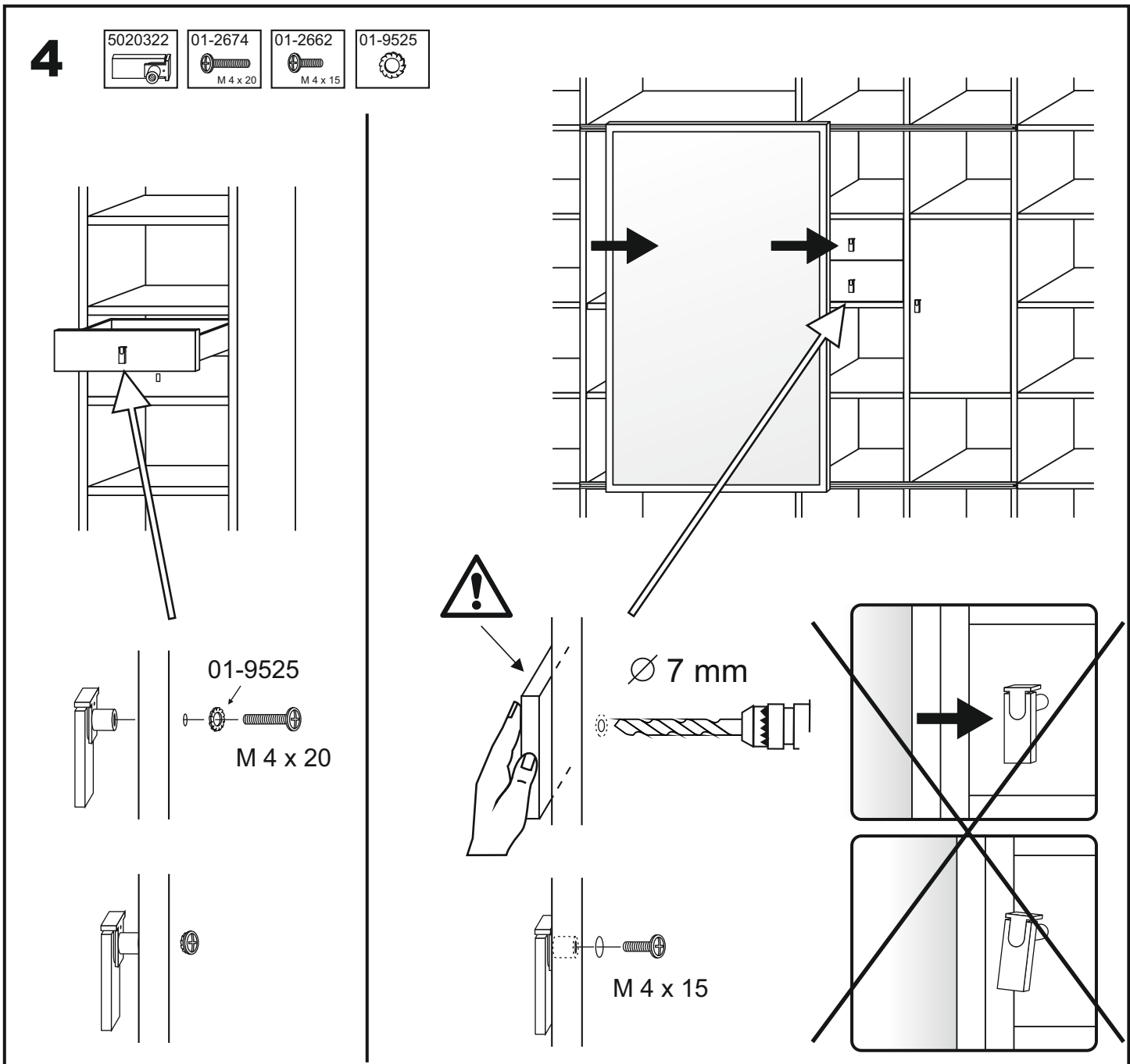
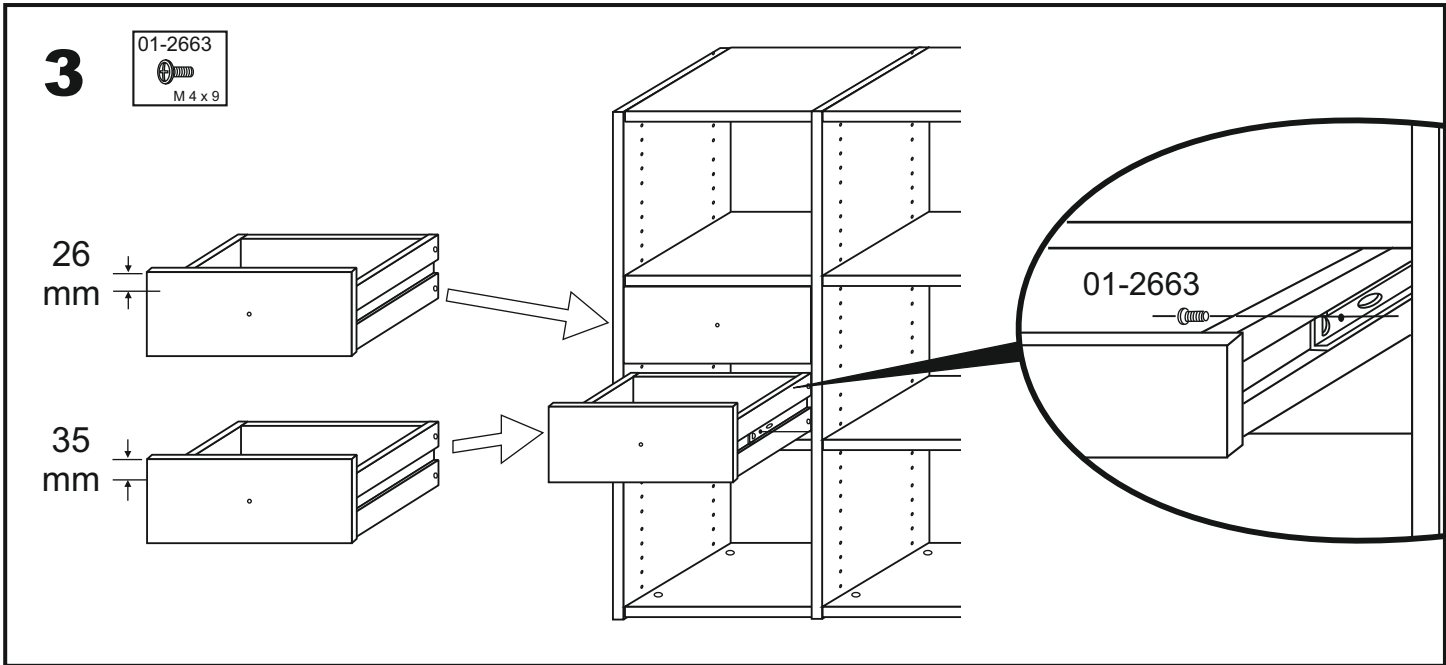

# DREHTÜR

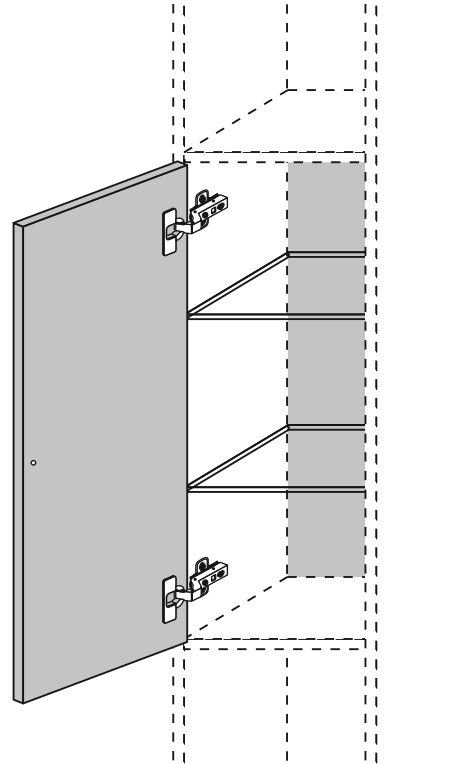
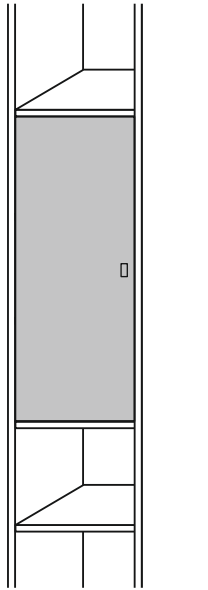

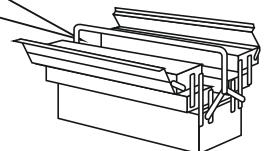
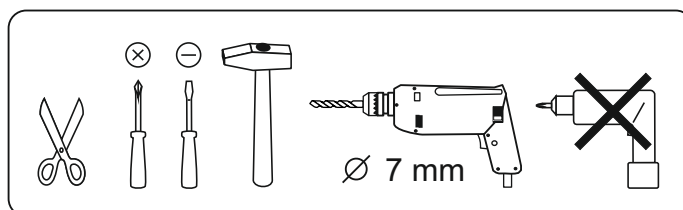
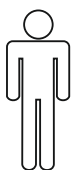

- |   |                                     |
|---|-------------------------------------|
| <b>(D)</b> Montageanleitung             | <b>(GB)</b> Assembly instructions   |
| <b>(FR)</b> Notice de montage           | <b>(IT)</b> Istruzioni di montaggio |
| <b>(NL)</b> Handleiding voor de montage | <b>(PL)</b> Instrukcja montażu      |
| <b>(CZ)</b> Montážní návod              | <b>(SK)</b> Návod na montáž         |
| <b>(HU)</b> Szerelési útmutató          | <b>(RO)</b> Instrucțiuni de montare |
| <b>(TR)</b> Montaj talimati             | <b>(RU)</b> инструкции по монтажу   |





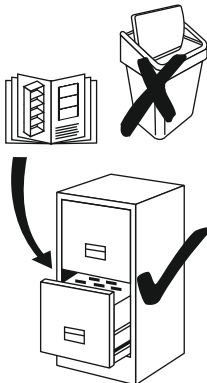
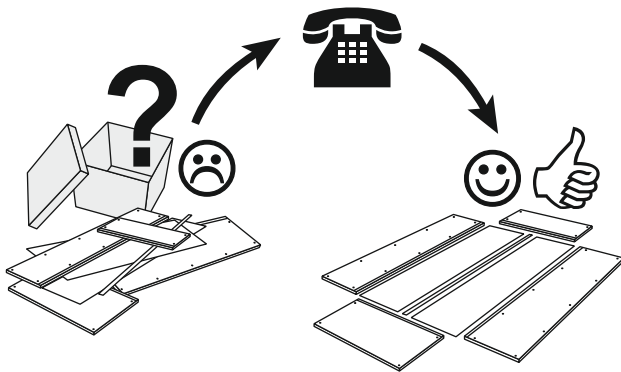

0 mm  
10  
20  
30  
40  
50  
60  
70  
80  
90  
100  
110  
120  
130  
140  
150

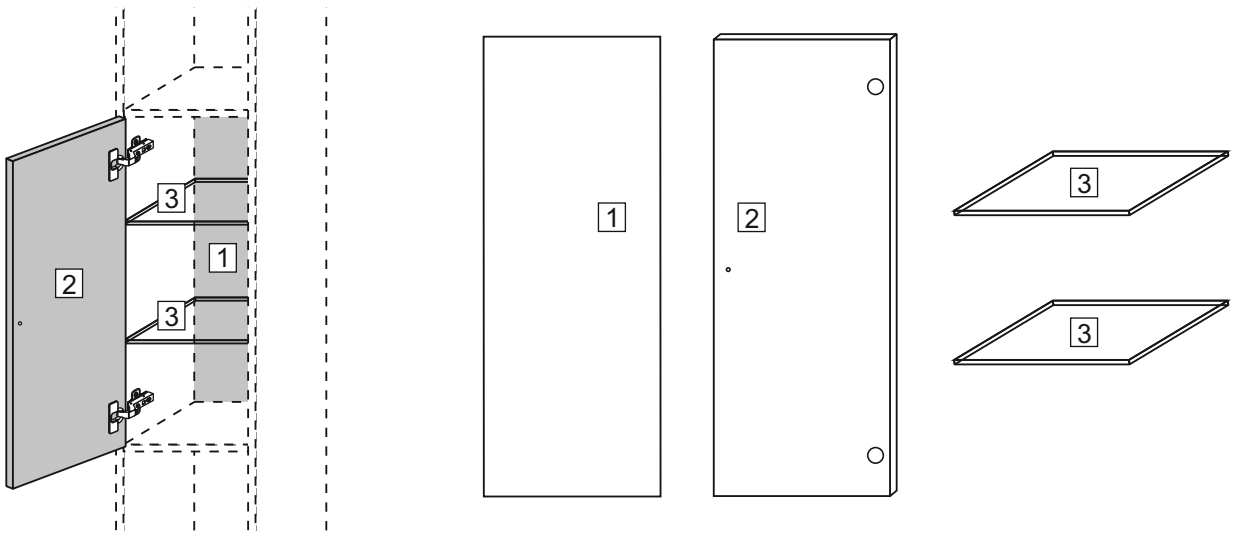
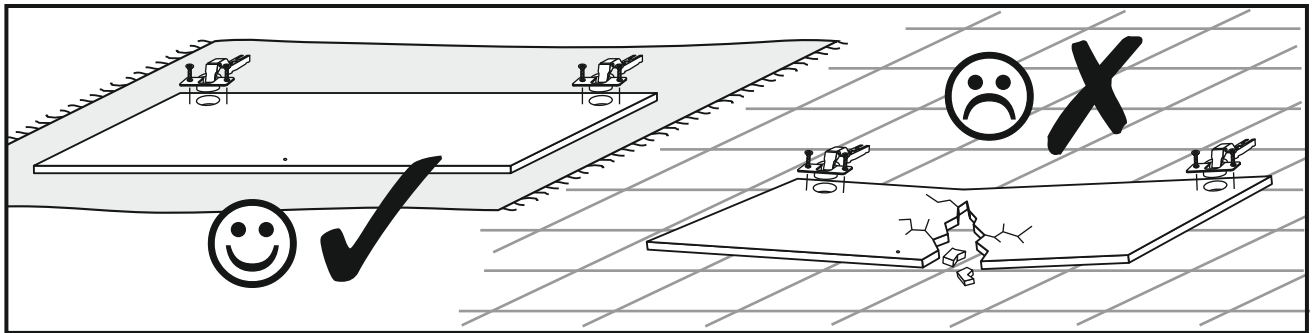
# Service - Assistenza - Dienstverlening - Serwis Servis Szerviz - Servicii - статистическая служба

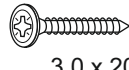
Name · Nom · Nome · Naam Nazwa · Jméno · Názov · Név Denumire · Isim · название		
Nr. · No. · N° · номеро · Č · Sz		
Тур · Туре · Тір · Típus · Тиро · тип		
		

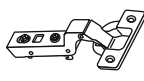

01-2506  
  
 3,0 x 20  
 16

1540004  
  
 2  
  
 2  
  
 2  
  
 2

01-2020  
  
 4,0 x 16  
 4

01-2019  
  
 4,0 x 15  
 4

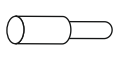
01-4706  
  
 8

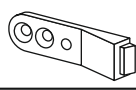
01-3048  
  
 1

01-2034  
  
 3,5 x 15  
 1

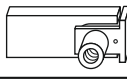
5020322  
  
 1

01-2674  
  
 M 4 x 20  
 1

01-2662  
  
 M 4 x 15  
 1

01-9525  
  
 1



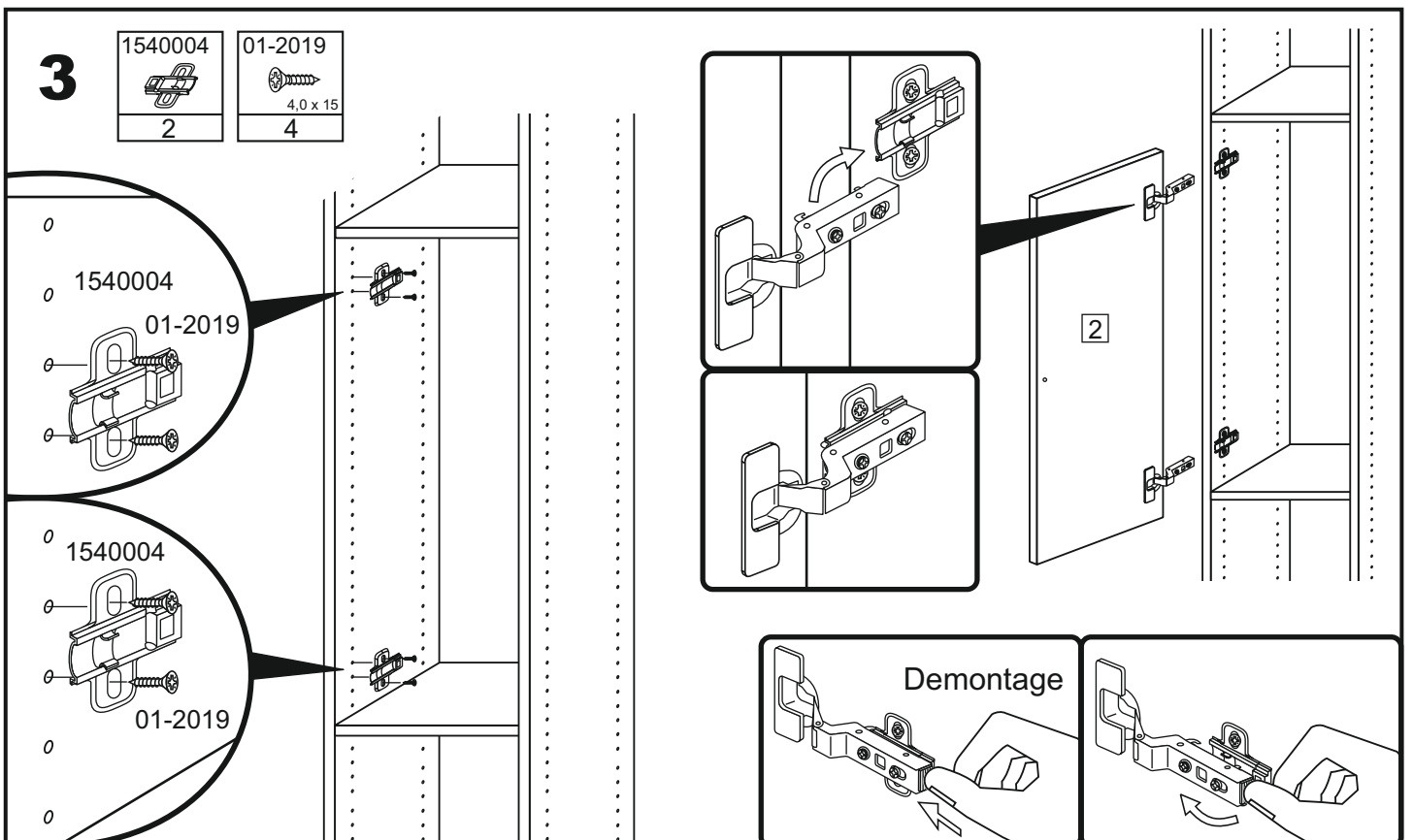
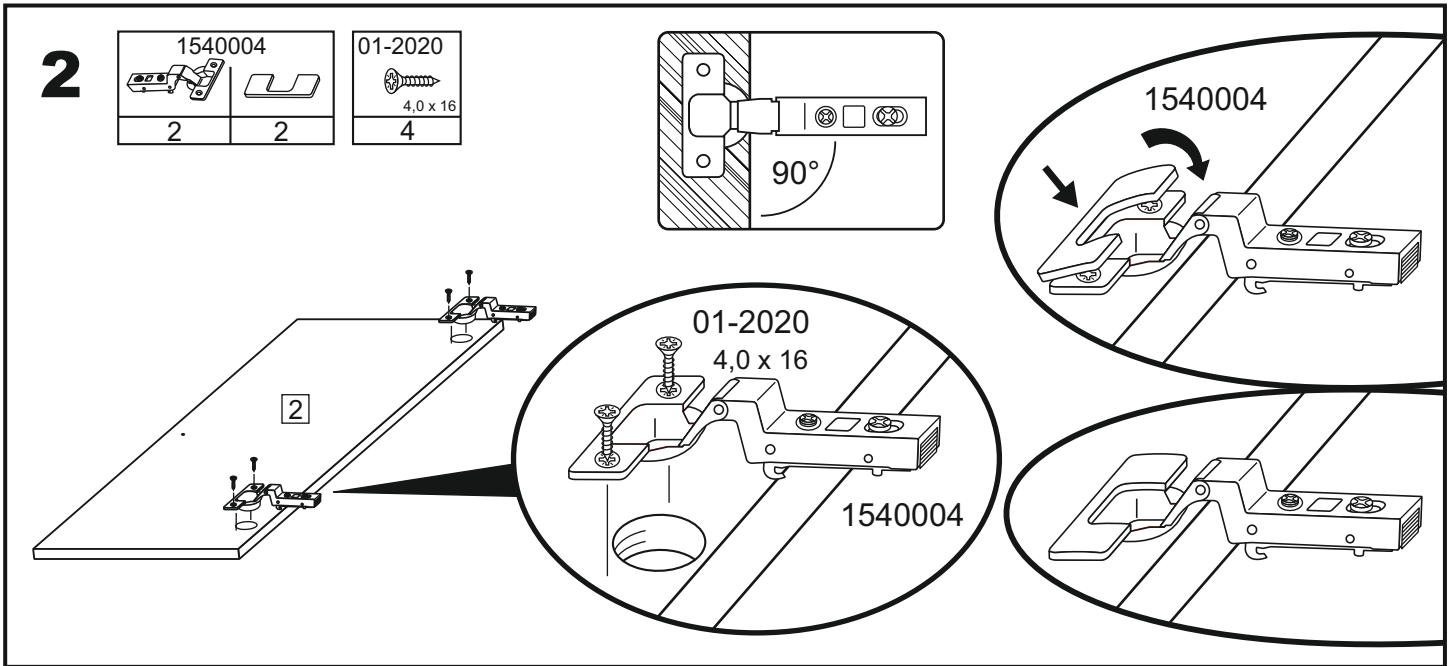
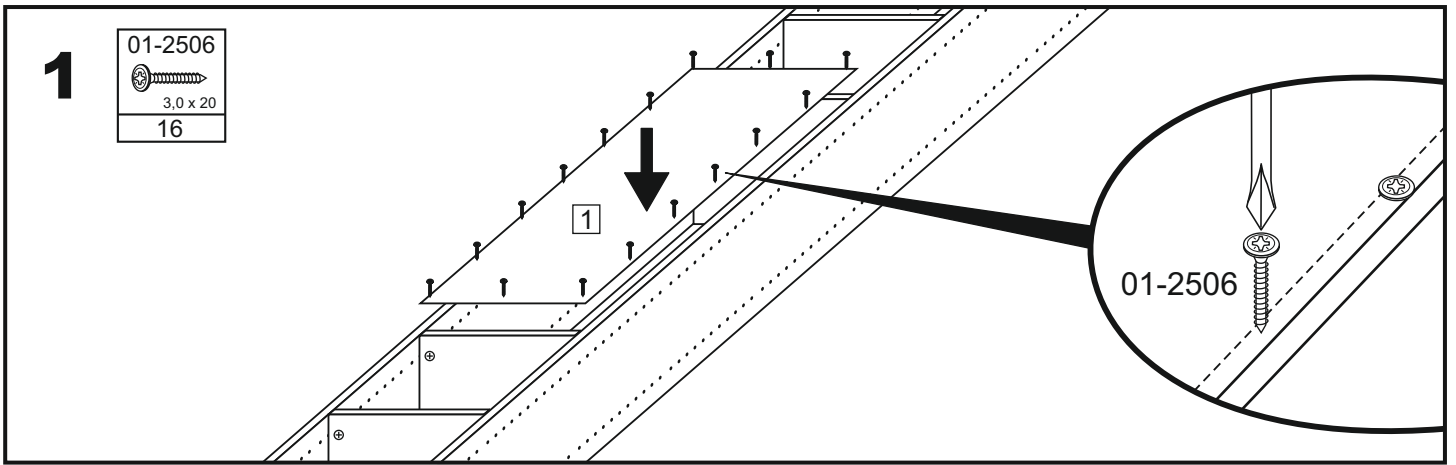

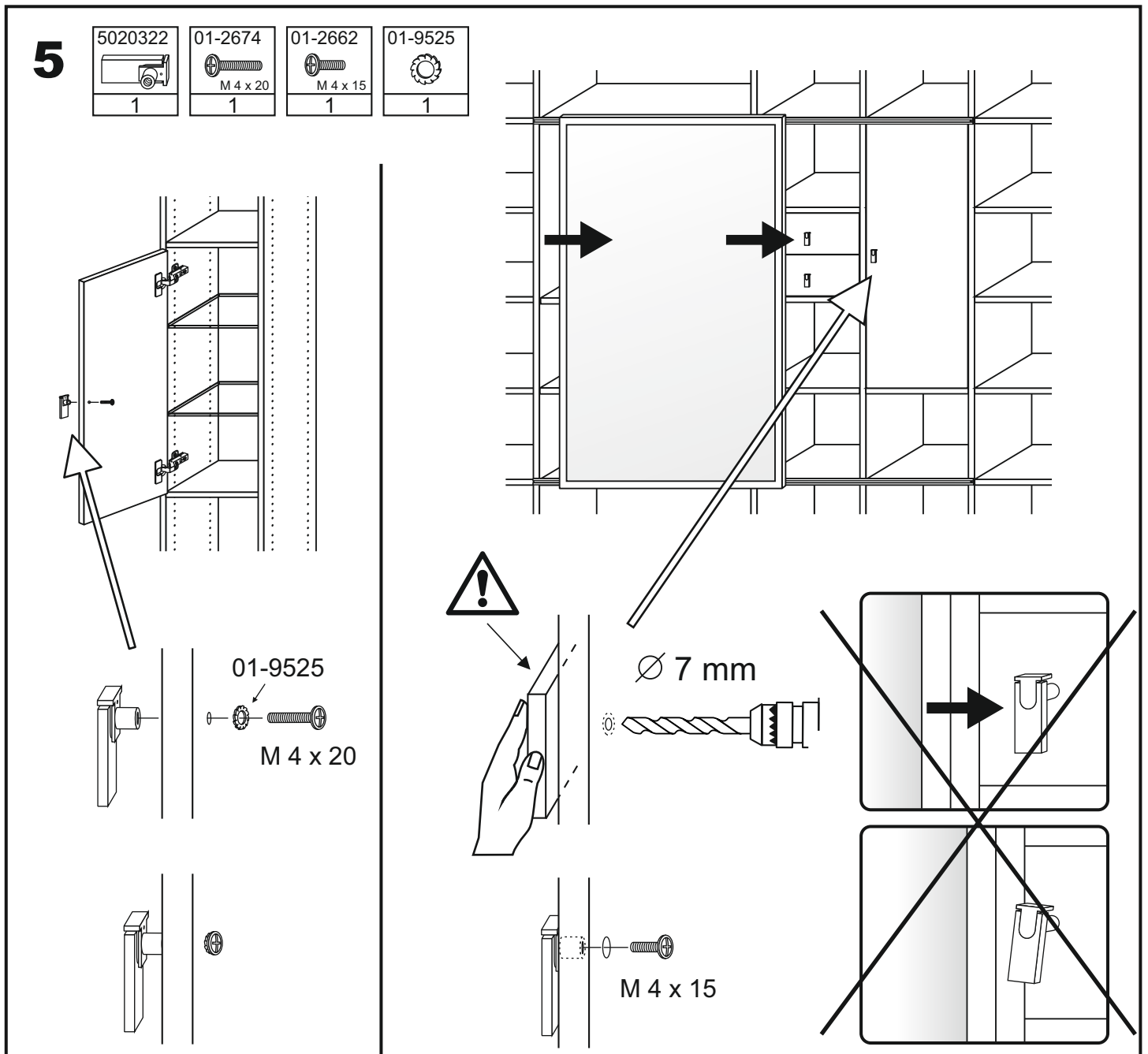
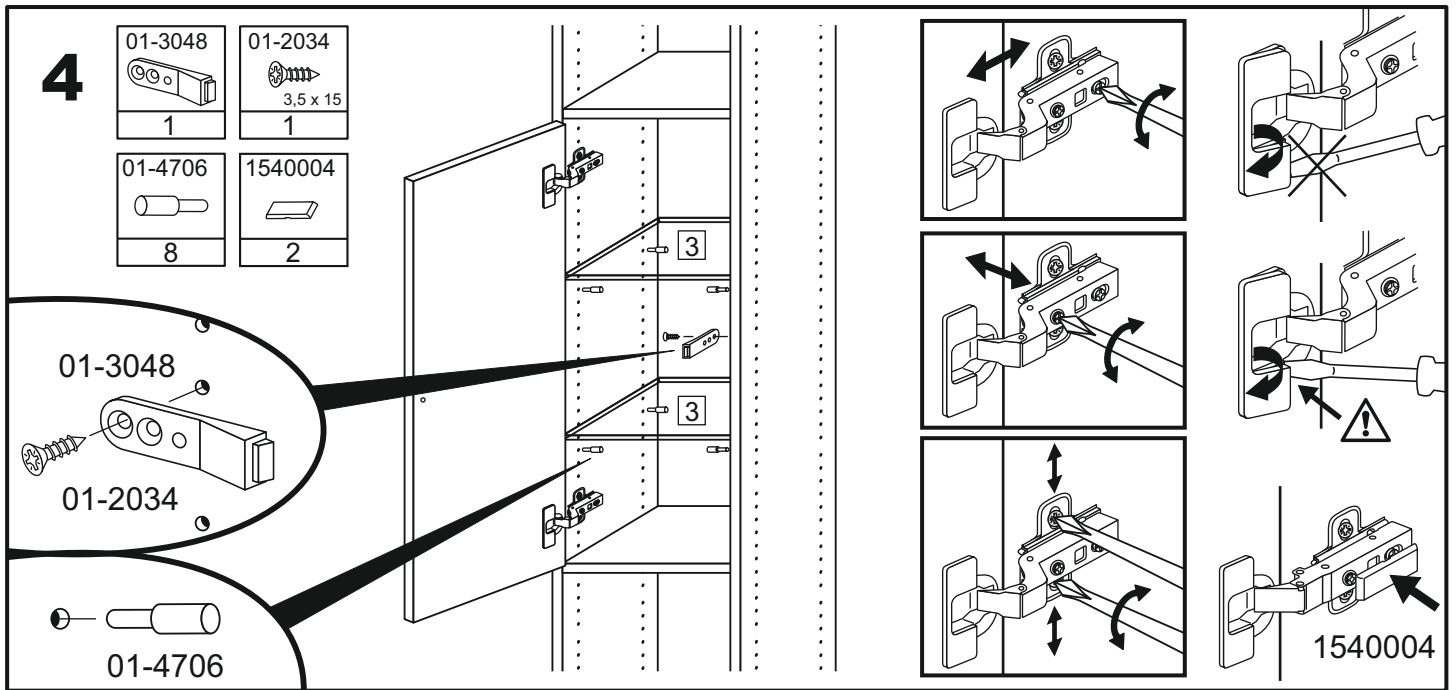

# SCHIEBETÜR



- |           |                             |           |                         |
|-----------|-----------------------------|-----------|-------------------------|
| <b>D</b>  | Montageanleitung            | <b>GB</b> | Assembly instructions   |
| <b>FR</b> | Notice de montage           | <b>IT</b> | Istruzioni di montaggio |
| <b>NL</b> | Handleiding voor de montage | <b>PL</b> | Instrukcja montażu      |
| <b>CZ</b> | Montážní návod              | <b>SK</b> | Návod na montáž         |
| <b>HU</b> | Szerelési útmutató          | <b>RO</b> | Instrucțiuni de montaj  |
| <b>TR</b> | Montaj talimatı             | <b>RU</b> | Инструкция по монтажу   |

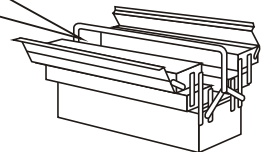
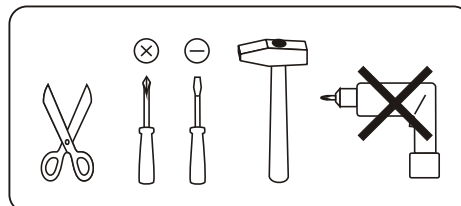
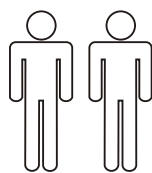

0 mm  
10  
20  
30  
40  
50  
60  
70  
80  
90  
100  
110  
120  
130  
140  
150  
160  
170  
180  
190  
200

Service • Asststenza • Dienstverlening • Serwis Servis • Szerviz • Сервисная служба		
Name • Nom • Nome • Naam Nazwa • Jméno • Názov • Név Denumire • Isim • Название		
Nr. • No. • N° • Номер • Č • Sz		
Тур • Type • Tip • Típus • Tipo • Тип		

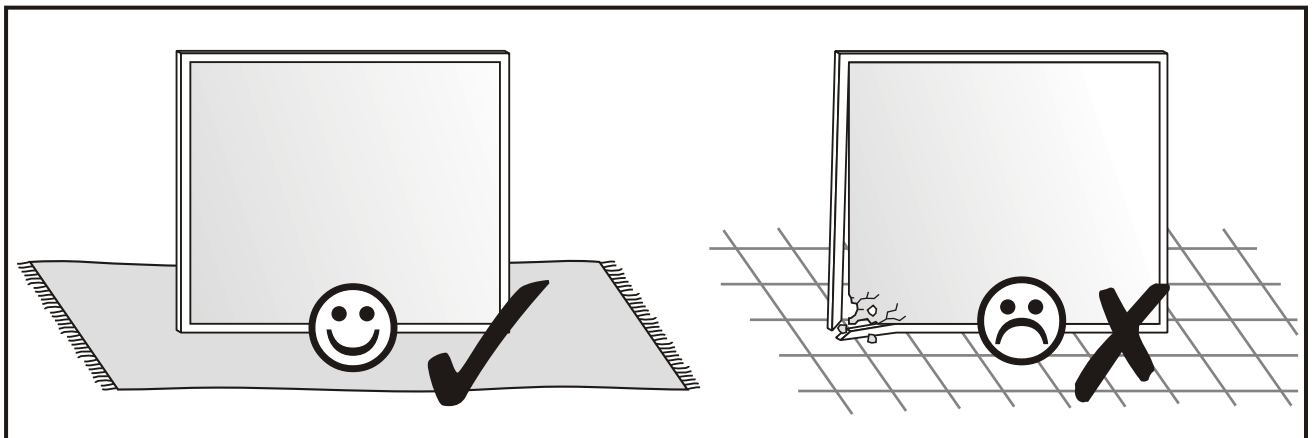

<b>A</b>  2	<b>B</b>  2	<b>C</b>  4	<b>D</b>  4	<b>01-2003</b>  4,0 x 40 14	<b>01-2602</b>  M 5 x 11 8
<b>5020120</b>  2	<b>5020121</b>  2	<b>01-9524</b>  8	<b>01-2661</b>  M 4 x 12 8		

<b>D</b>	Bitte nur mit einem Staubtuch oder leicht feuchtem Lappen reinigen. Keine scheuernden Putzmittel verwenden.	<b>CZ</b>	Čistěte prosím jen prachovkou nebo lehce navlhčeným hadrem. Nepoužívejte drhňoucí čističí prostředky.
<b>GB</b>	Please only clean with a duster or a damp cloth. Do not use any abrasive cleaners.	<b>SK</b>	Na čistenie používajte len prachovku alebo zľahka navlhčenú utierku. Nepoužívajte žiadne drhňúce čistiace prostriedky.
<b>F</b>	Veillez nettoyer uniquement avec un chiffon à poussière ou un chiffon légèrement humide. Ne pas utiliser de détergent abrasif.	<b>HU</b>	Kérjük, csak portörölő kendővel vagy enyhén nedves ronggyal tisztítsa. Ne használjon dörzshatású tisztítószeret.
<b>IT</b>	Si raccomanda di pulire solo con un panno per la polvere o uno strofinaccio umido. Non utilizzare detergenti abrasivi.	<b>RO</b>	Vă rugăm să utilizați la curățare exclusiv o cârpă de șters praful sau o cârpă ușor umezită. Nu utilizați substanțe de curățat abrazive.
<b>NL</b>	Reinig alleen met een stofdoek of een lichtjes vochtige doek. Gebruik geen schurende poetsmiddelen.	<b>TR</b>	Lütfen sadece bir toz bezikle veya hafif nemli yumuşak bir bezle siliniz. Aşındırıcı temizlik malzemeleri kullanmayınız.
<b>PL</b>	Czyszczenie należy wykonać wyłącznie za pomocą ściereczki lub lekko nawilżonego ręcznika. Nie stosować środków czyszczących do szorowania.	<b>RU</b>	Очищайте от пыли тряпкой или слегка влажной ветошью. Не допускается применение чистящих средств, не предназначенных для ухода за мебелью.

