

Fargo

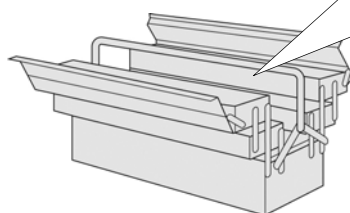

- | | |
|-----------------------------|----------------------------------|
| (D) Montageanleitung | (GB) Assembly instructions |
| (FR) Notice de montage | (NL) Handleiding voor de montage |
| (CZ) Montážní návod | (IT) Istruzioni di montaggio |
| (RO) Instrucțiuni de montaj | (RU) инструкция по сборке |
| (PL) Instrukcja montażu | (SK) Návod na montáž |
| (HU) Szerelési útmutató | (TR) Montaj talimati |

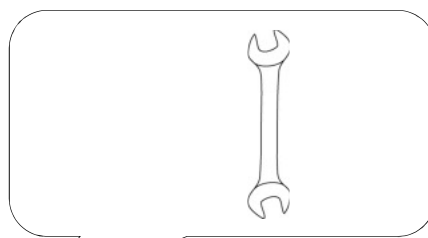

0
10
20
30
40
50
60
70
80
90
100
110
120
130
140
150
160
170
180
190
200

| Service • Assistenza • Dienstverlening • Serwis Servis • Szerviz • Сервисная служба | |
|--|------------------|
| Name • Nom • Nome • Naam Nazwa • Jméno • Názov • Név Denumire • Ísim • Название | Fargo 140 |
| Nr. • No. • N° • Номер • Č • Sz | SH50 |
| Typ • Type • Tip • Típus • Tipo Тип | BS G |
| | |
| | |

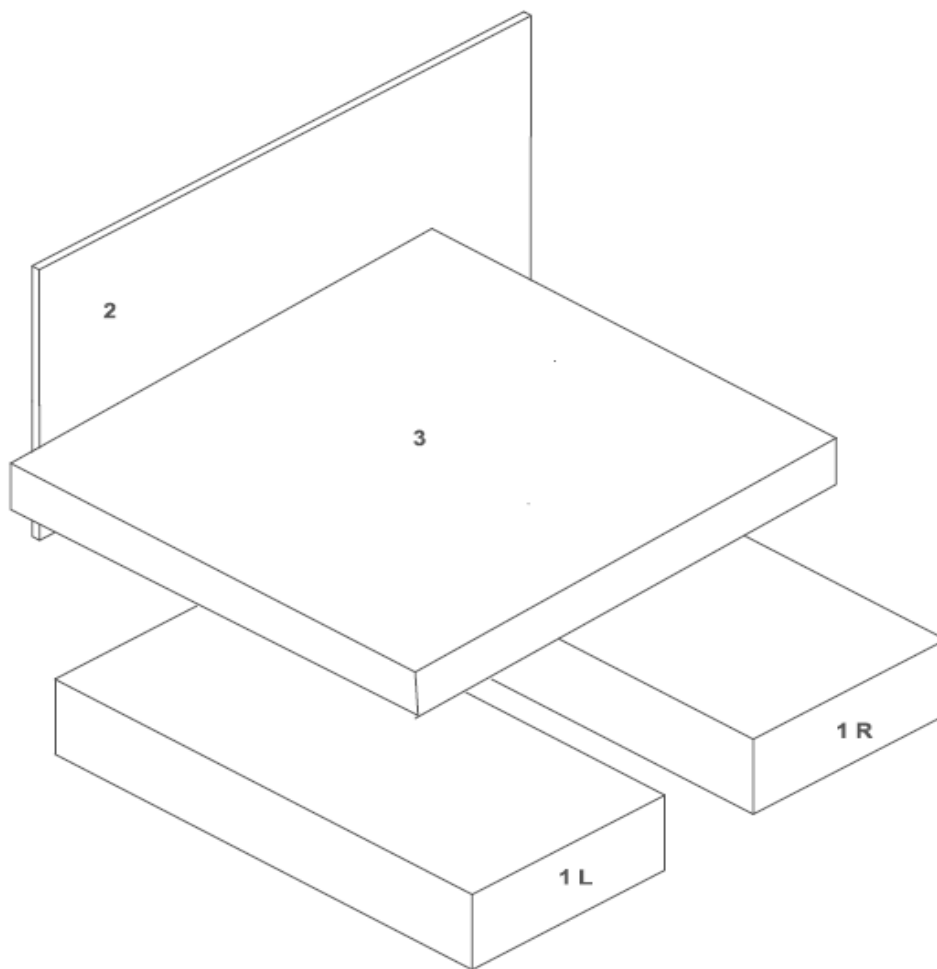

| A | B | C | D | E | F | G |
|----|---------|----------|----|---------|---------|-------|
| | | | | | | |
| 4x | 4x 8x45 | 12x 8x40 | 8x | 8x 8x50 | 8x 8x60 | 8x M8 |



| | | |
|---|--|---------|
| A | | 4x |
| B | | 4x 8x45 |
| C | | 4x 8x40 |
| D | | 8x |
| E | | 8x 8x50 |

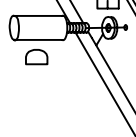
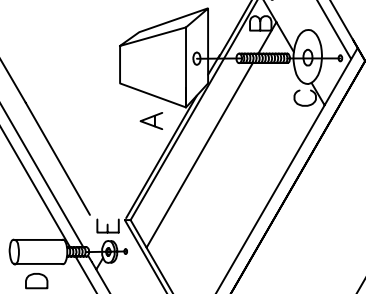
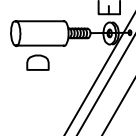
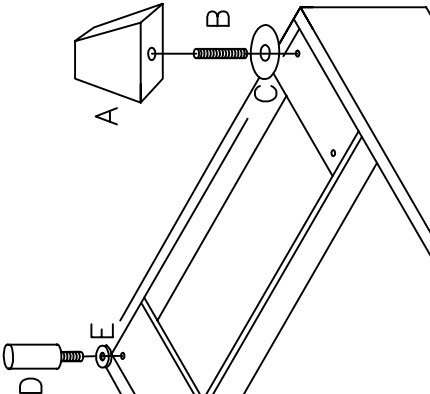
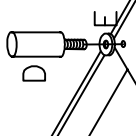
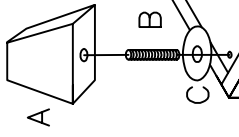
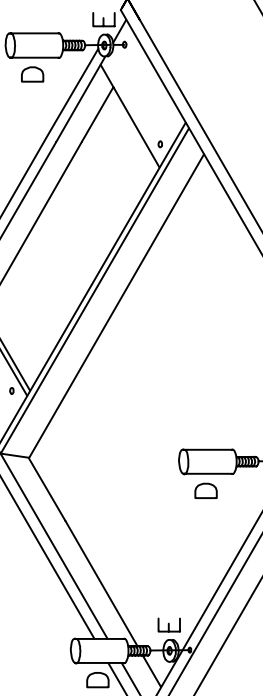
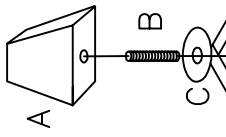

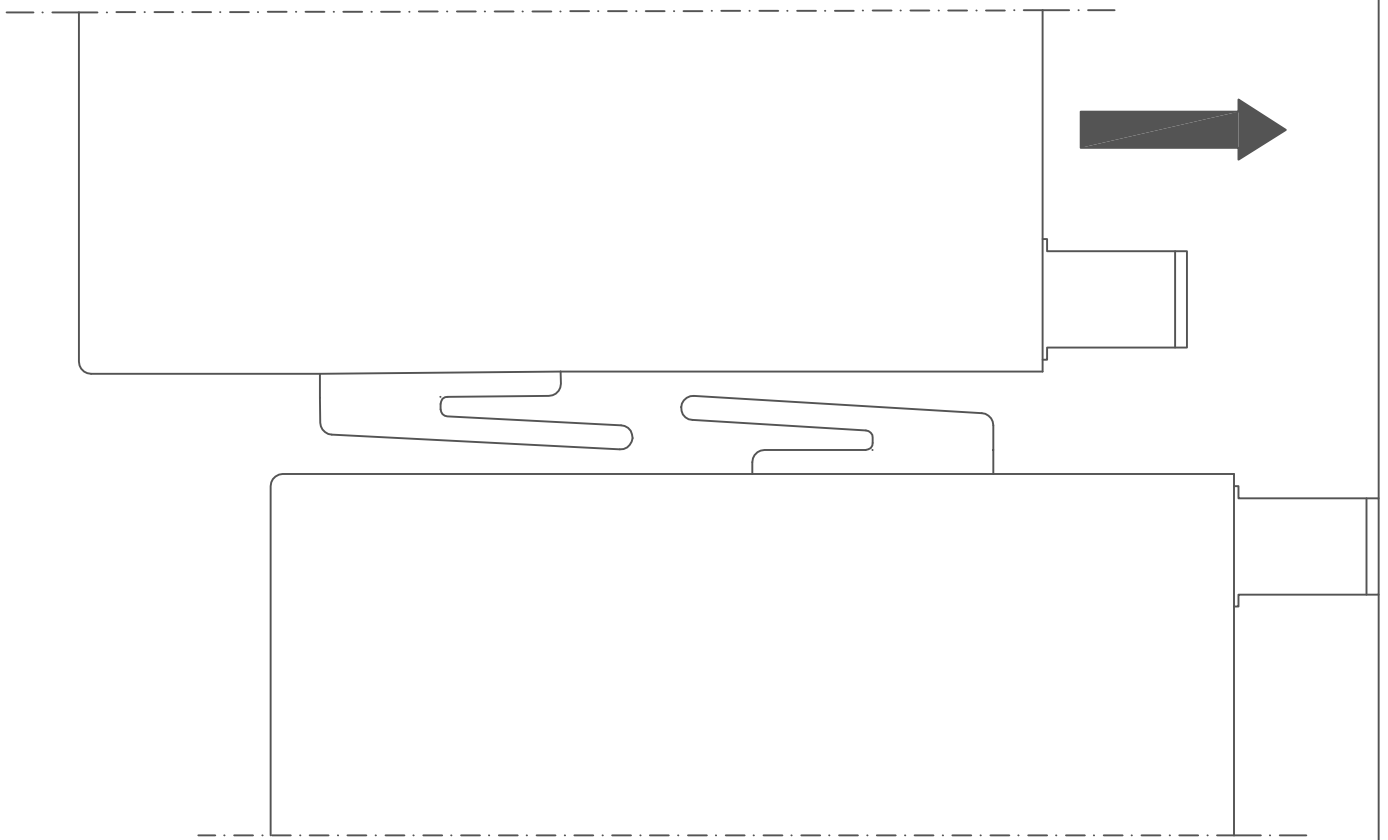



3.

Achtung! Schrauben nicht überdrehen
 FR Attention! Ne serrez pas trop
 CZ Dávej Pozor! Nepřetahujte
 RO Ai Grija! Nu strângeți
 PL Uważaj! Nie dokręcać zbyt mocno
 HU Vigyázz! Ne húzza túl

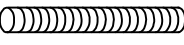
GB Watch Out! Do not over tighten
 NL Let Op! Niet te vast
 IT Attento! Non stringere
 RU Осторожно! Не затягивайте
 SK Dávaj Pozor! Nepretahujte
 TR Dikkat! Üzerinde sıkmayın

| | | | |
|---------|---|-------|---|
| F |  | G |  |
| | | C |  |
| 8x 8x60 | 8x 8x40 | 8x M8 | |

