



**ERST-HOLZ**<sup>®</sup>

WWW.ERST-HOLZ.DE

Artikel-Nr.: 60.61-14

Datum: 21.02.2023

Seite 01 von 04

# Montageanleitung

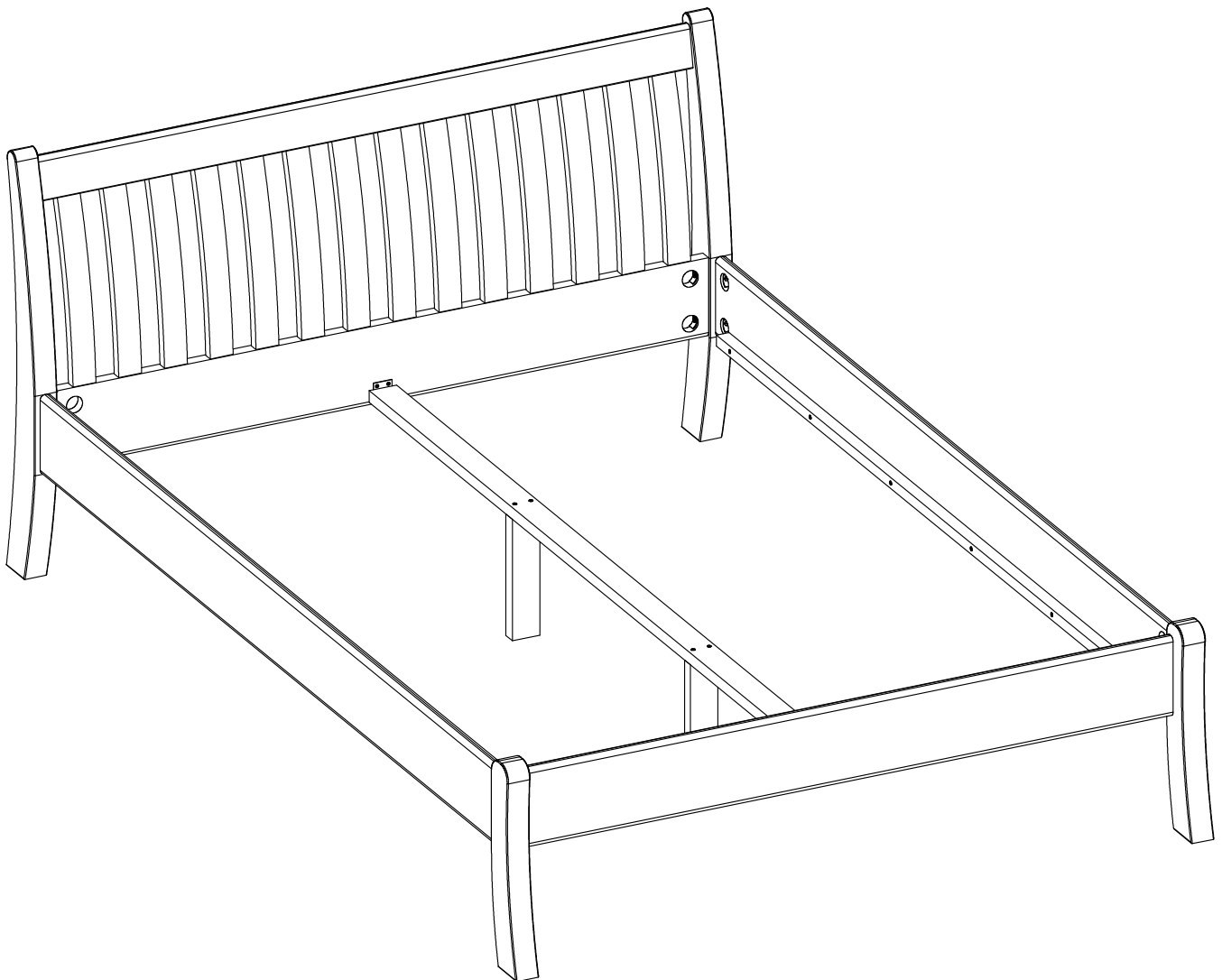

---

**ERST-HOLZ**<sup>®</sup> - die Marke für gute Holzprodukte

Steinhaus Handelsgesellschaft mbH & Co KG - Schauerödstr. 21 - 94152 Neuhaus - Tel.: 0 8503 924540

E-Mail: [auftrag@erst-holz.de](mailto:auftrag@erst-holz.de)

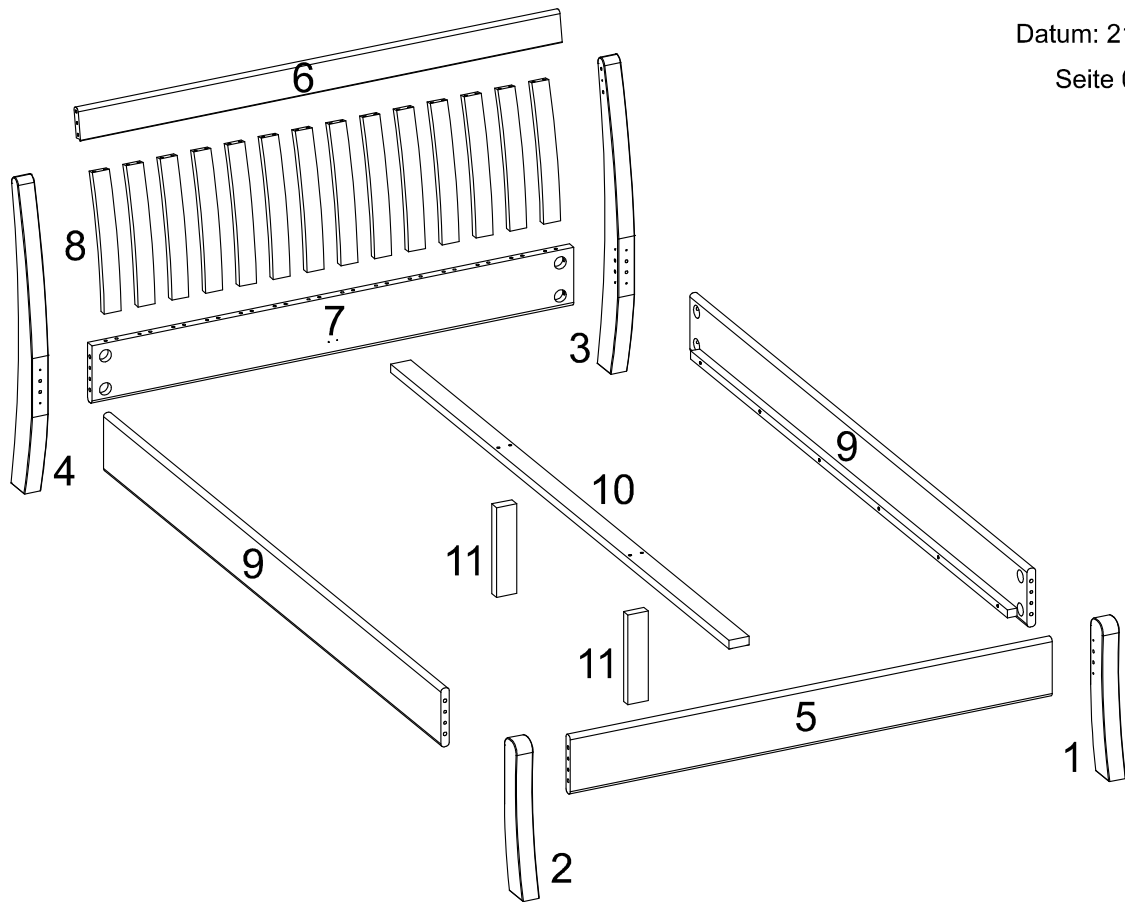

**Achtung!**





Bevor Sie die Schrauben, Dübel, Muttern in die dafür vorgesehenen Löcher stecken, prüfen Sie, ob sich gegebenenfalls noch Holzspäne in den Löchern befinden.

Das Bett beim Verschieben unbedingt anheben. Es könnten sonst die mittleren Stützfüße abknicken und die Mittelleiste dann bei Belastung brechen.

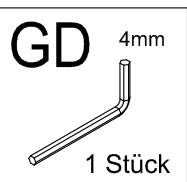
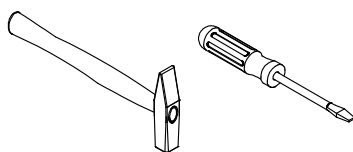
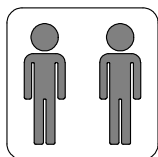

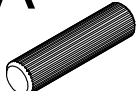
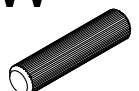
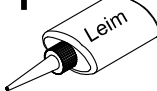
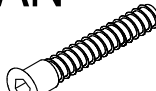
Sie benötigen zum Aufbau:

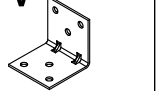

<b>A</b> Ø10x40mm  20 Stück	<b>W</b> Ø8x35mm  56 Stück	<b>Y</b> Leim  2 Stück	<b>AN</b> Ø7x50mm  18 Stück	<b>CG</b> Ø3,5x16mm  10 Stück	<b>FU</b>  18 Stück	<b>FV</b> 40x40x40mm  2 Stück	<b>FW</b> Ø4,0x60mm  4 Stück
---	---	---	--	--	--	--	---

Teile-Nr	Bezeichnung	Anzahl
1	Pfosten Fußteil rechts	1
2	Pfosten Fußteil links	1
3	Pfosten Kopfteil rechts	1
4	Pfosten Kopfteil links	1
5	Fußteilleiste	1
6	Kopfteilleiste oben	1
7	Kopfteilleiste unten	1
8	Sprossen	14
9	Seite rechts/links	2
10	Mittelleiste	1
11	Stützfüße	2

1

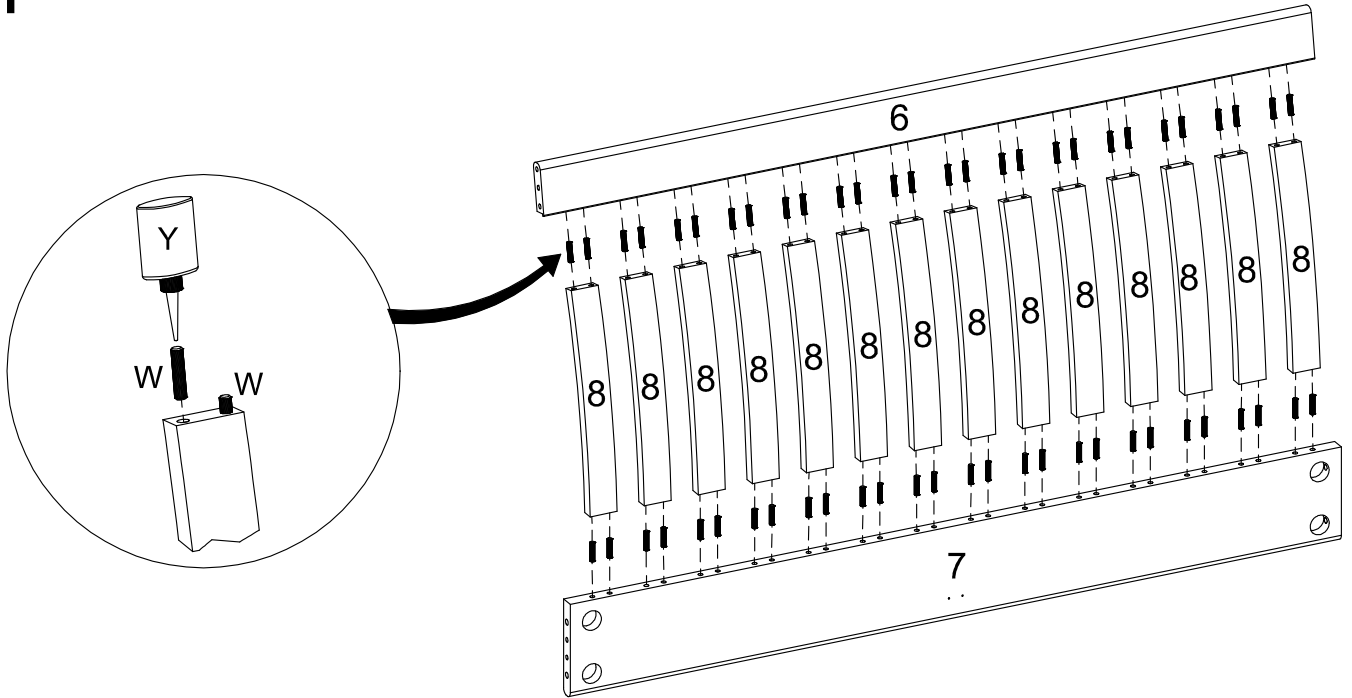

2

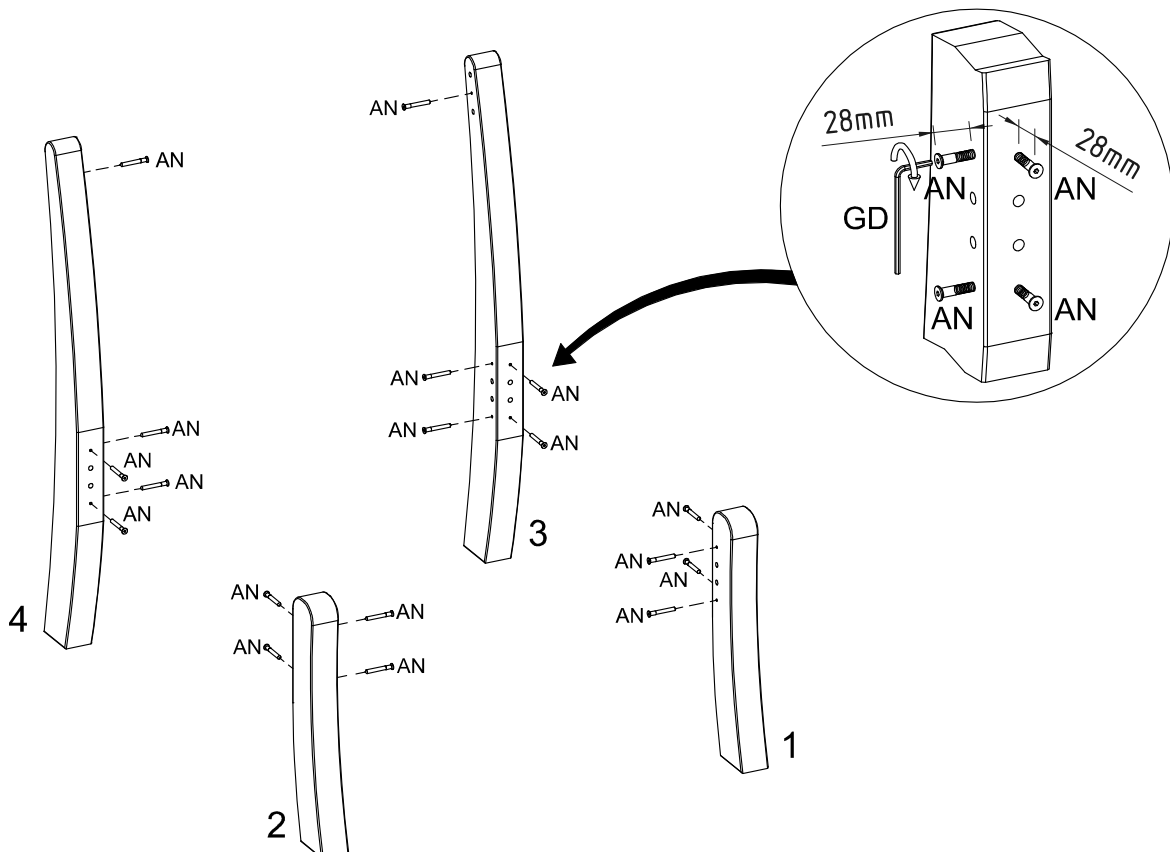

3

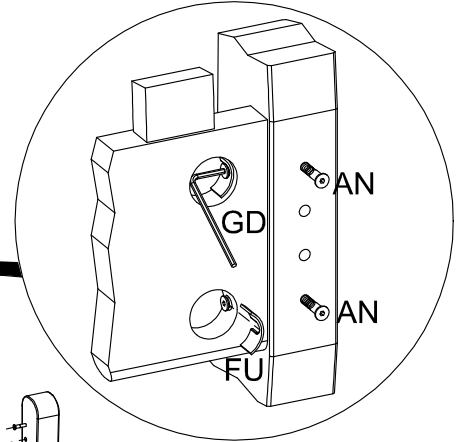
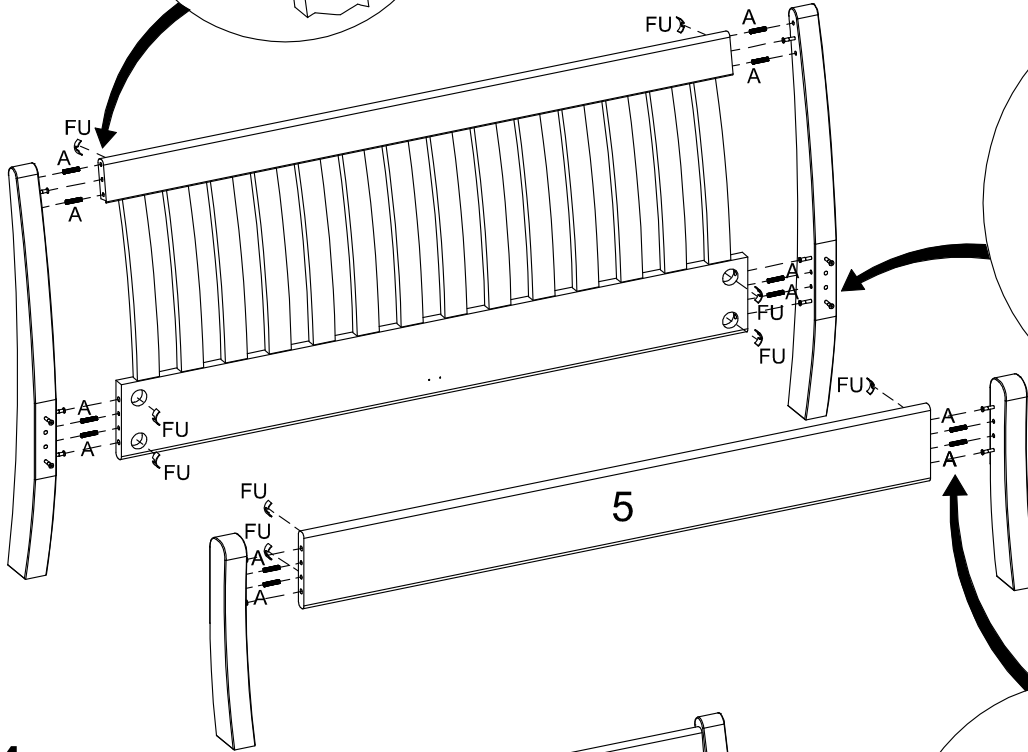
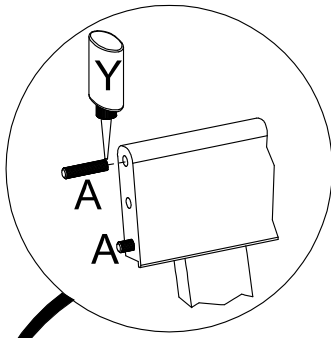

4

