

BENDIGO V  
8100/2500-0037/8242  
8241/2500-0037/8300



201101

- |           |  |           |   |
|-----------|--|-----------|---|
| <b>D</b>  | MONTAGEANLEITUNG<br>BEDIENUNGSANLEITUNG                | <b>GB</b> | ASSEMBLY INSTRUCTIONS<br>INSTRUCTION MANUAL         |
| <b>NL</b> | HANDLEIDING VOOR DE MONTAGE<br>GEBRUIKSAANWIJZING      | <b>PL</b> | INSTRUKCJA MONTAŻU<br>INSTRUKCJA OBSŁUGI            |
| <b>TR</b> | MONTAJ TALIMATI<br>KULLANIM KLAVUZU                    | <b>RU</b> | ИНСТРУКЦИЯ ПО МОНТАЖУ<br>ИНСТРУКЦИЯ ПО ЭКСПЛУАТАЦИИ |
| <b>RO</b> | INSTRUCȚIUNI DE INSTALARE<br>INSTRUCȚIUNI DE UTILIZARE | <b>IT</b> | ISTRUZIONI DI MONTAGGIO<br>MANUALE DI ISTRUZIONI    |
| <b>FR</b> | NOTICE DE MONTAGE<br>MANUEL INSTRUCTIONS               | <b>SK</b> | MONTÁŽNY NÁVOD<br>NÁVOD NA POUŽITIE                 |
| <b>HU</b> | KÖZGYŰLÉS UTASÍTÁSOK<br>KEZELÉSI UTASÍTÁS              | <b>CZ</b> | MONTÁŽNÍ NÁVOD<br>NÁVOD K POUŽITÍ                   |
| <b>SI</b> | NAVODILA ZA MONTAŽO<br>NAVODILA ZA UPORABO             | <b>PT</b> | INSTRUÇÕES DE MONTAGEM<br>MANUAL DO USUÁRIO         |
| <b>ES</b> | INSTRUCCIONES DE MONTAJE<br>MANUAL DEL USUARIO         | <b>HR</b> | UPUTE ZA MONTAŽU<br>UPUTE ZA UPOTREBU               |

**R**

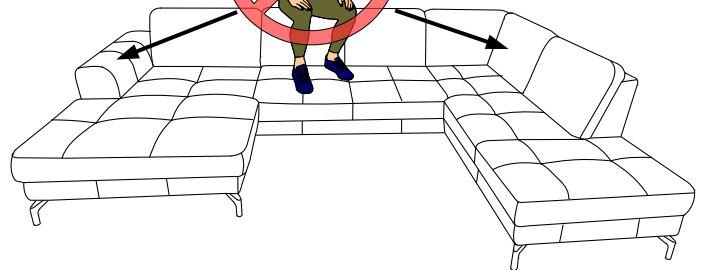

**L**

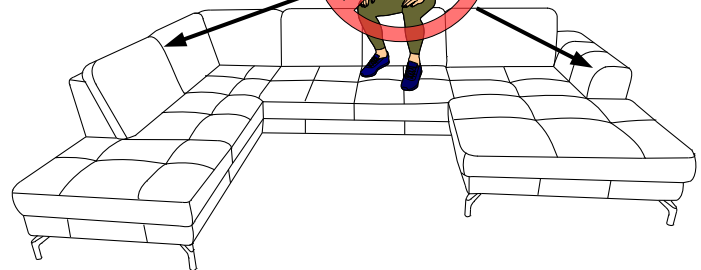



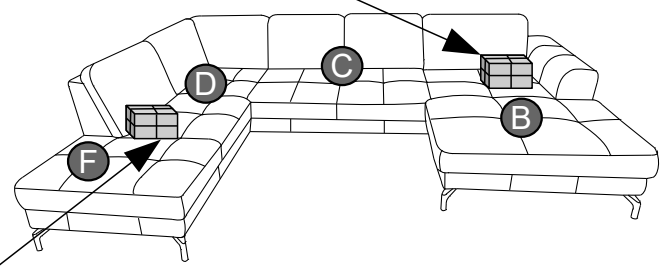
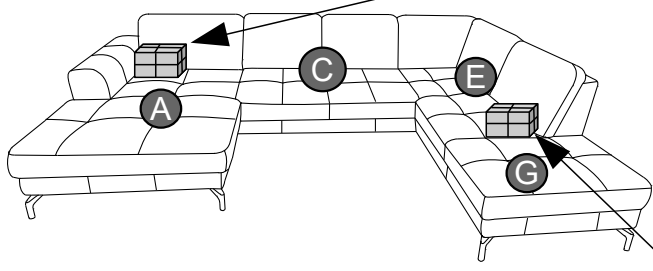

<b>y</b> <sub>H-120/150</sub>  X1	<b>z</b> <sub>H(120-180)</sub>  X2	<b>q</b> M6*25  X12	<b>i</b> L-4  X1	<b>x</b> <sub>H-120/150</sub> [mm]  X3
---	--	---------------------------	------------------------	--

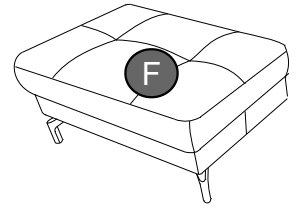
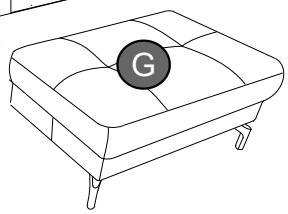
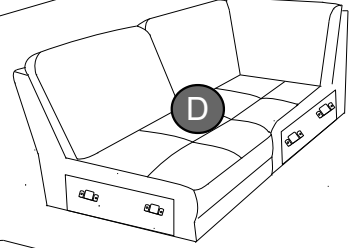
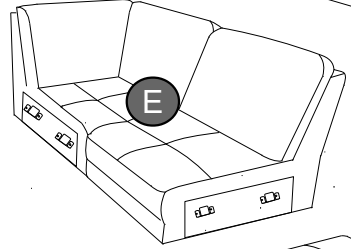
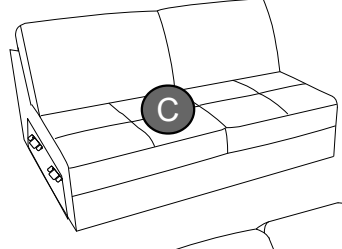
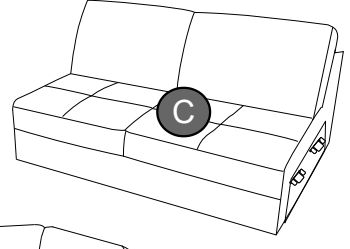
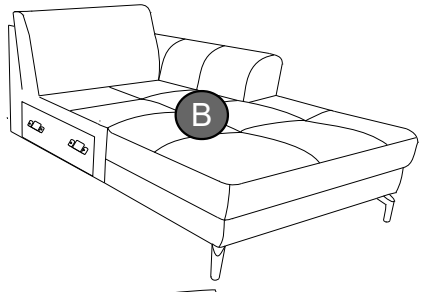
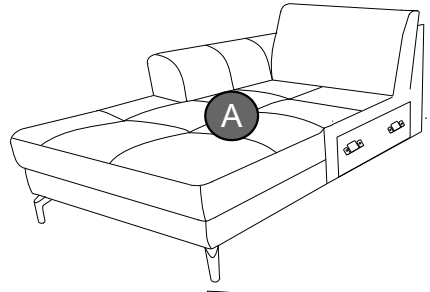

<b>y</b> <sub>H-120/150</sub>  X1	<b>z</b> <sub>H(120-180)</sub>  X3	<b>q</b> M6*25  X12	<b>i</b> L-4  X1	<b>x</b> <sub>H-120/150</sub>  X3
---	--	---------------------------	------------------------	---



<b>y</b> H-120/150 	<b>Z</b> H(120-180) 	<b>x</b> H-120/150 	<b>q</b> M6*25 	<b>i</b> L-4 
X2	X5	X6	X24	X1

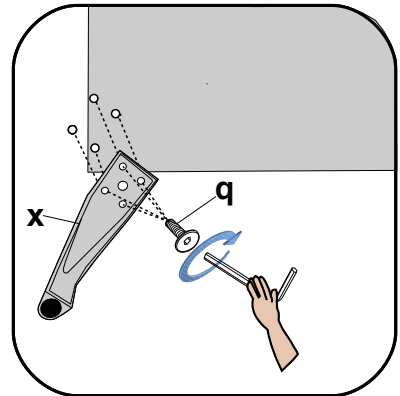
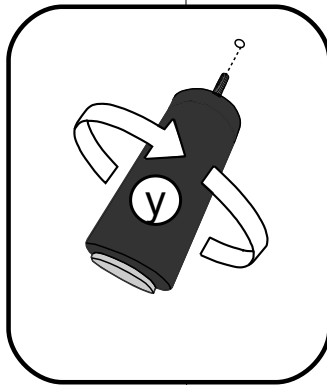
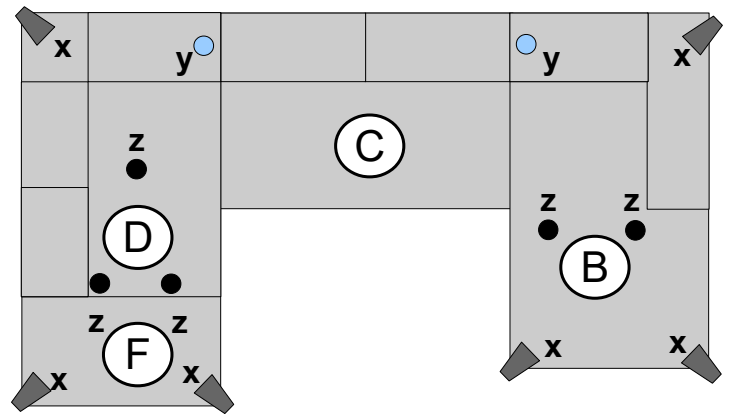
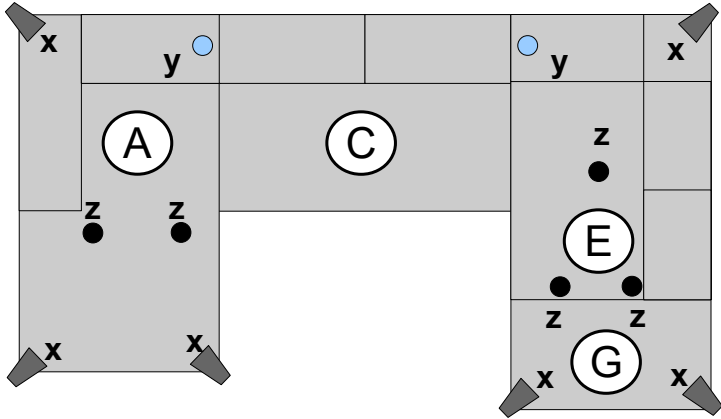
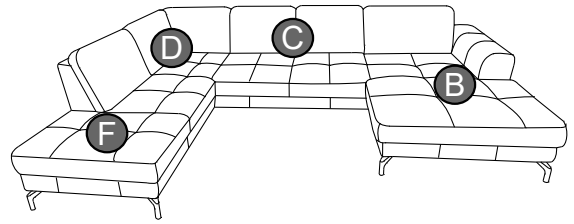
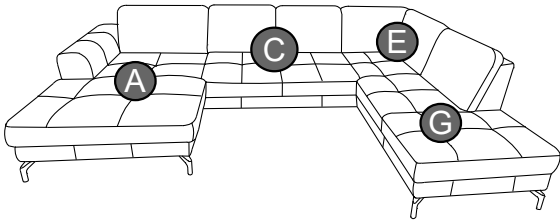



120/150

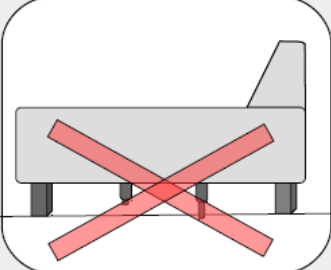

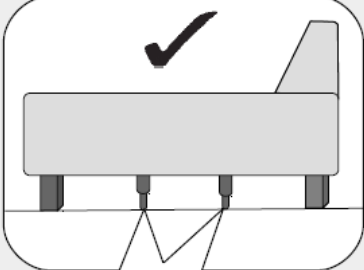



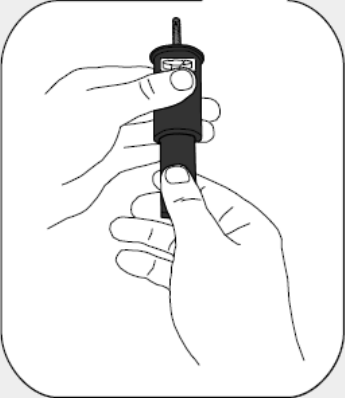

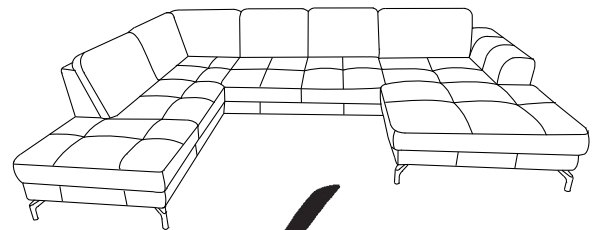
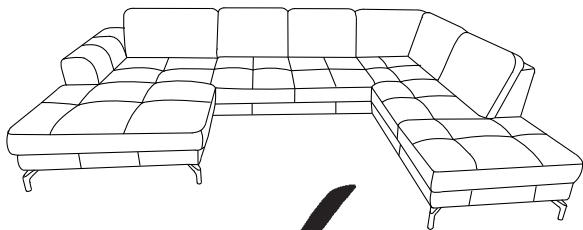
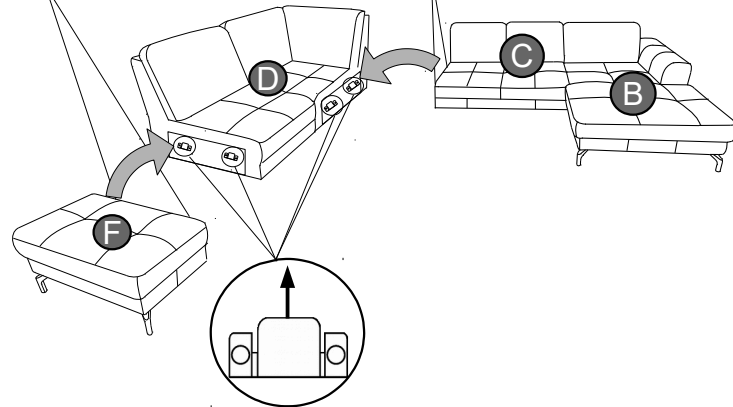
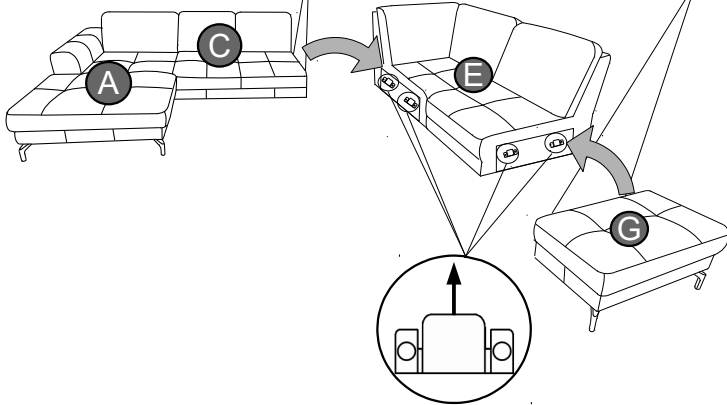
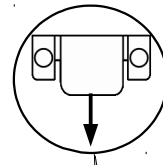
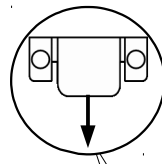
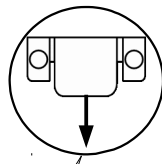
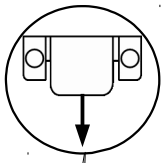
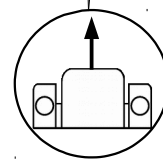
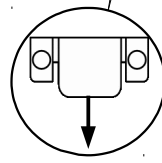
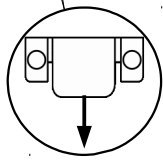
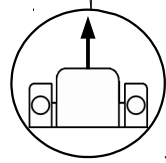
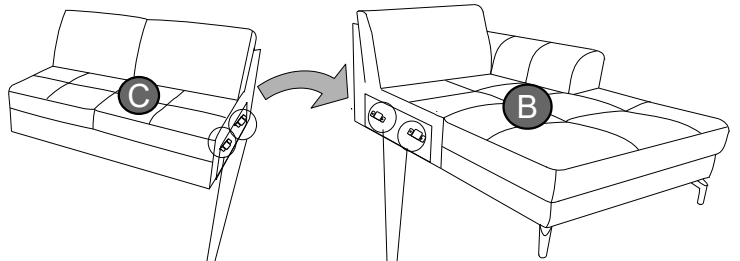
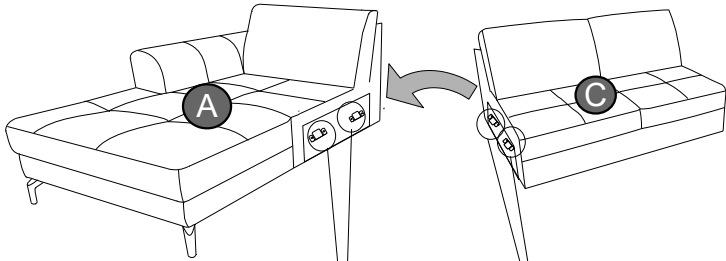
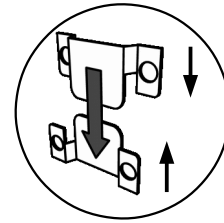
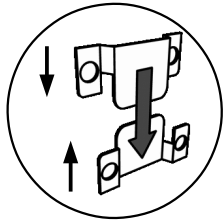
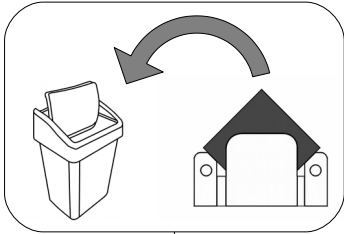

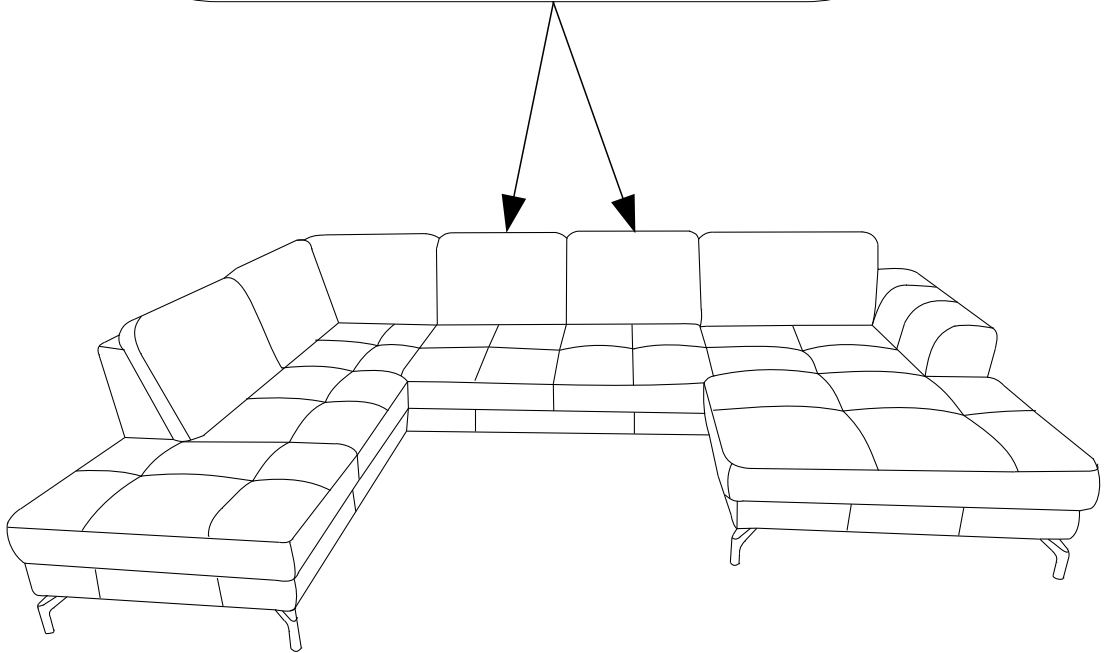
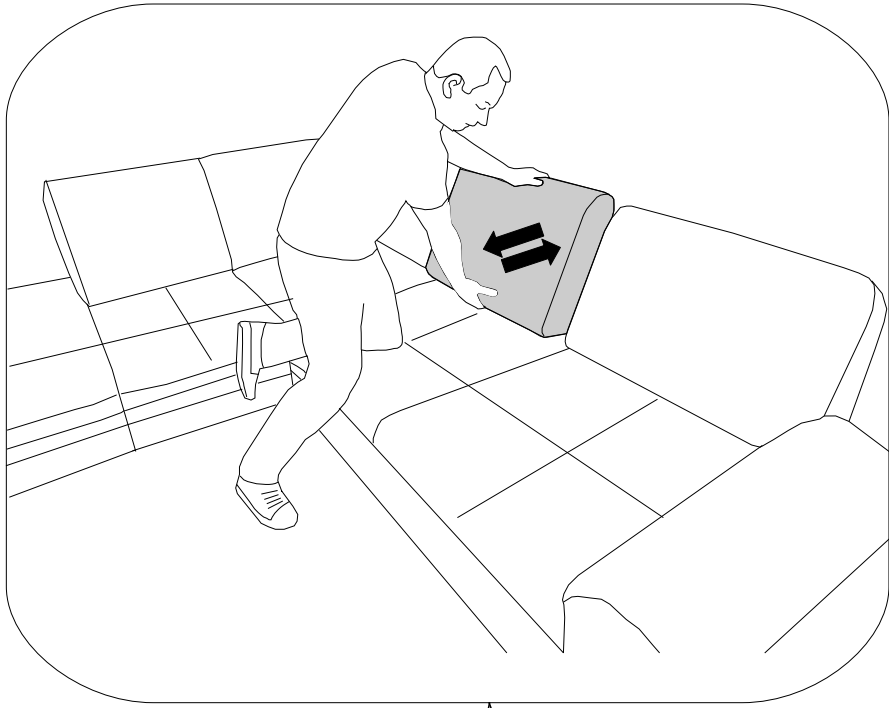

Name · Naam · Nazwa · Ísim · Название · Nume · Nome · Názov · Názov ·  
 Název · Neve

**BENDIGO V**

Typ · Type · Tip · Тип · Tipo · Típus

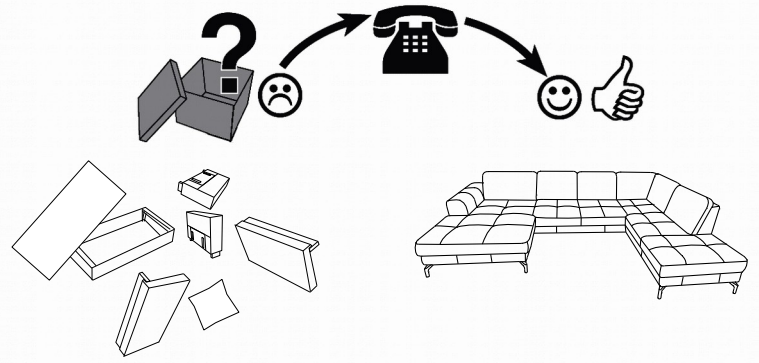
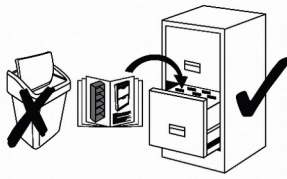

**R**

**L**

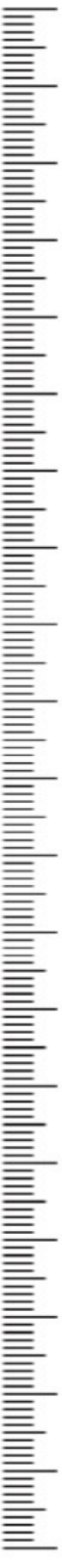
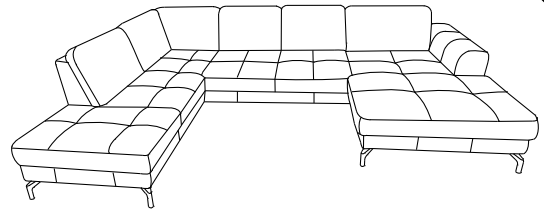
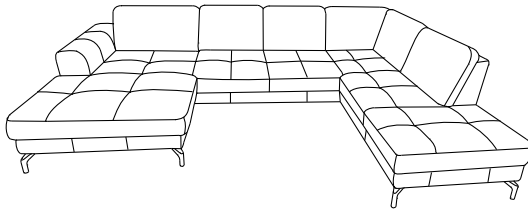

<b>y</b> H-120/150 	<b>z</b> H(120-180) 	<b>x</b> H-120/150 	<b>q</b> M6*25 	<b>i</b> L-4 [mm] 
------------------------	-------------------------	------------------------	--------------------	-----------------------

