

## 41961

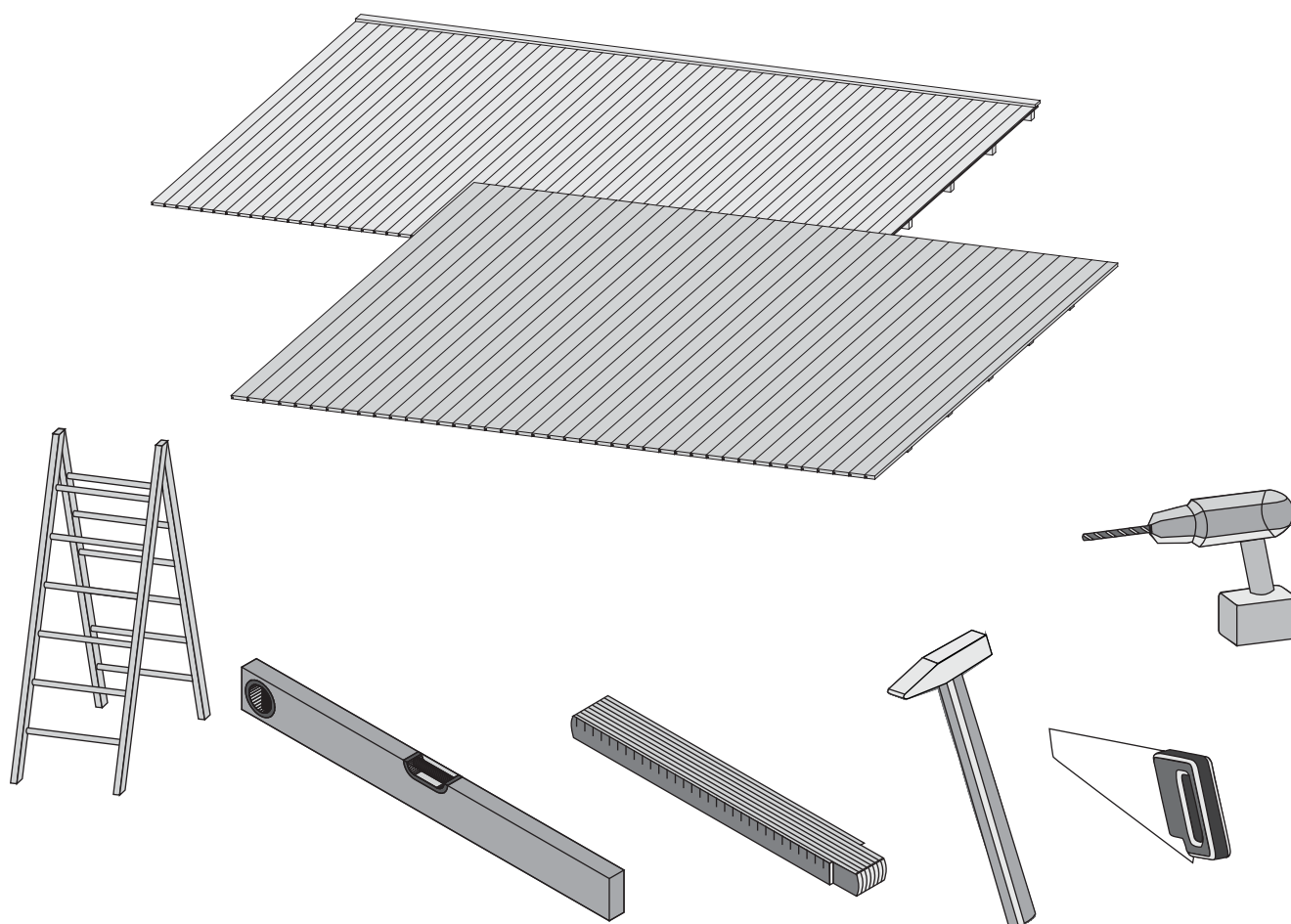

 **Aufbauanleitung**

 **Building Instructions**

 **notice de montage**

 **montagehandleiding**

 **Montagevejledning**

 **Instrucciones de construcción**

 **Istruzioni per il montaggio**

 **Montážní návod**



**+49 421 38693 33**



Vergleichen Sie zuerst die Material-liste mit Ihrem Paketinhalt! Bitte haben Sie Verständnis, dass Beanstandungen nur im nicht aufgebauten Zustand bearbeitet werden können!



Vergelijk eerst de lijst van materialen met de inhoud van uw pakket! Reclamaties kunnen alleen in behandeling worden genomen zolang de onderdelen nog niet zijn gemonteerd!



Confrontate questa distinta materiali prima con il contenuto del pacchetto! Vi preghiamo di comprendere che eventuali reclami possono essere accolti solo prima del montaggio!



First compare the list of materials with your package contents! Please understand that complaints can be processed in the non-built status only!



Start med at kontrollere materialelisten med indholdet af den leverede pakke! Vi gør venligst opmærksom på at reklamationer kun kan behandles for materialer som ikke er blevet bearbejdet!



Nejprve přezkontrolujte obsah balení podle materiálového listu! Mějte pochopení pro to, že případnou reklamaci se můžeme zabývat pouze tehdy, když díly nebudou smontované! Za pomoci tohoto seznamu můžete jednotlivé díly přiřadit k montážnímu návodu.



Commencez par comparer la liste du matériel avec le contenu de votre paquet! Sachez que nous traitons uniquement les réclamations concernant le matériel à l'état non monté!



En primer lugar, compare la lista de material con el contenido del paquete. Rogamos entienda que las reclamaciones sólo pueden ser tramitadas antes de montar el objeto!

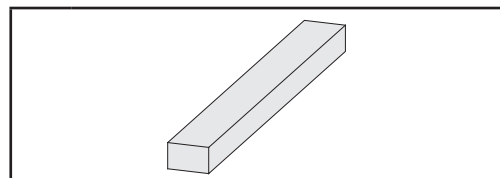
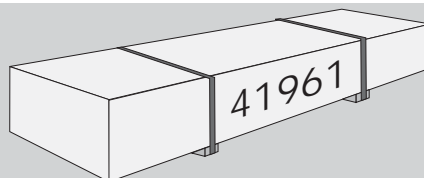

1 x U1	3645 x	95 x	18 mm	ID 42425
5 x U2	3690 x	60 x	40 mm	ID 28688

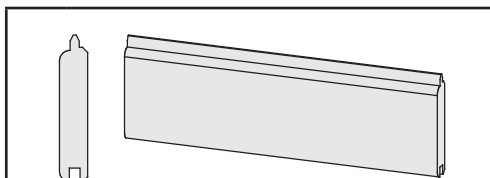



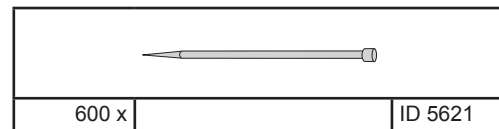



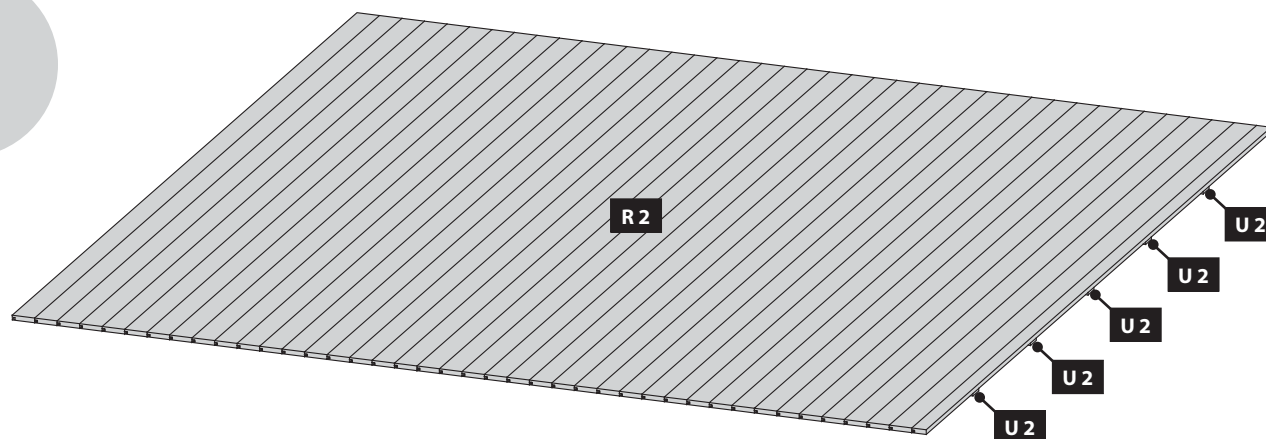
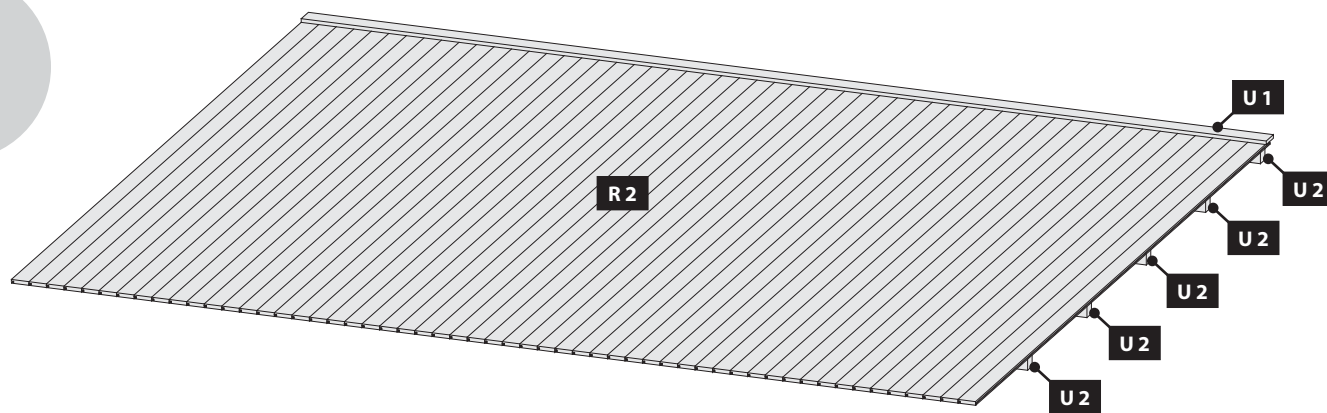

42 x R2	3600 x	96 x	16 mm	ID 19572
---------	--------	------	-------	----------



600 x	ID 5621
-------	---------











-  Lieber Kunde, achten Sie auf die richtige Aufbau-Variante!
-  Dear customer, pay attention to the correct design variant!
-  Cher client, attention à la version de montage correct!
-  Geachte klant, let dan op de juiste montage-versie!
-  Geachte klant, let dan op de juiste montage-versie!
-  Estimado cliente, prestar atención a la versión montaje correcto!
-  Caro cliente, prestare attenzione alla versione corretto montaggio!
-  Vážení zákazník, dbát na správnou montážní verzi!

# A

**87039**











-  Aufbauanleitung
-  Building Instructions
-  notice de montage
-  montagehandleiding
-  Montagevejledning
-  Instrucciones de construcción
-  Istruzioni per il montaggio
-  Montážní návod

☎ +49 421 3880 33

**67556**











-  Aufbauanleitung
-  Building Instructions
-  notice de montage
-  montagehandleiding
-  Montagevejledning
-  Instrucciones de construcción
-  Istruzioni per il montaggio
-  Montážní návod

☎ +49 421 3880 33

**64295**











-  Aufbauanleitung
-  Building Instructions
-  notice de montage
-  montagehandleiding
-  Montagevejledning
-  Instrucciones de construcción
-  Istruzioni per il montaggio
-  Montážní návod

☎ +49 421 3880 33

**87036**











-  Aufbauanleitung
-  Building Instructions
-  notice de montage
-  montagehandleiding
-  Montagevejledning
-  Instrucciones de construcción
-  Istruzioni per il montaggio
-  Montážní návod

☎ +49 421 3880 33

**67524**











-  Aufbauanleitung
-  Building Instructions
-  notice de montage
-  montagehandleiding
-  Montagevejledning
-  Instrucciones de construcción
-  Istruzioni per il montaggio
-  Montážní návod

☎ +49 421 3880 33

# B

**81869**











-  Aufbauanleitung
-  Building Instructions
-  notice de montage
-  montagehandleiding
-  Montagevejledning
-  Instrucciones de construcción
-  Istruzioni per il montaggio
-  Montážní návod

☎ +49 421 3880 33

**88422 88424**











-  Aufbauanleitung
-  Building Instructions
-  notice de montage
-  montagehandleiding
-  Montagevejledning
-  Instrucciones de construcción
-  Istruzioni per il montaggio
-  Montážní návod

☎ +49 421 3880 33

**82884 82885**











-  Aufbauanleitung
-  Building Instructions
-  notice de montage
-  montagehandleiding
-  Montagevejledning
-  Instrucciones de construcción
-  Istruzioni per il montaggio
-  Montážní návod

☎ +49 421 3880 33

**81876**











-  Aufbauanleitung
-  Building Instructions
-  notice de montage
-  montagehandleiding
-  Montagevejledning
-  Instrucciones de construcción
-  Istruzioni per il montaggio
-  Montážní návod

☎ +49 421 3880 33

**67421 67423**



-  Aufbauanleitung
-  Building Instructions
-  notice de montage
-  montagehandleiding
-  Montagevejledning
-  Instrucciones de construcción
-  Istruzioni per il montaggio
-  Montážní návod

☎ +49 421 3880 33

# A

01

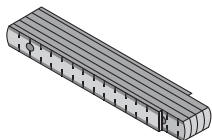
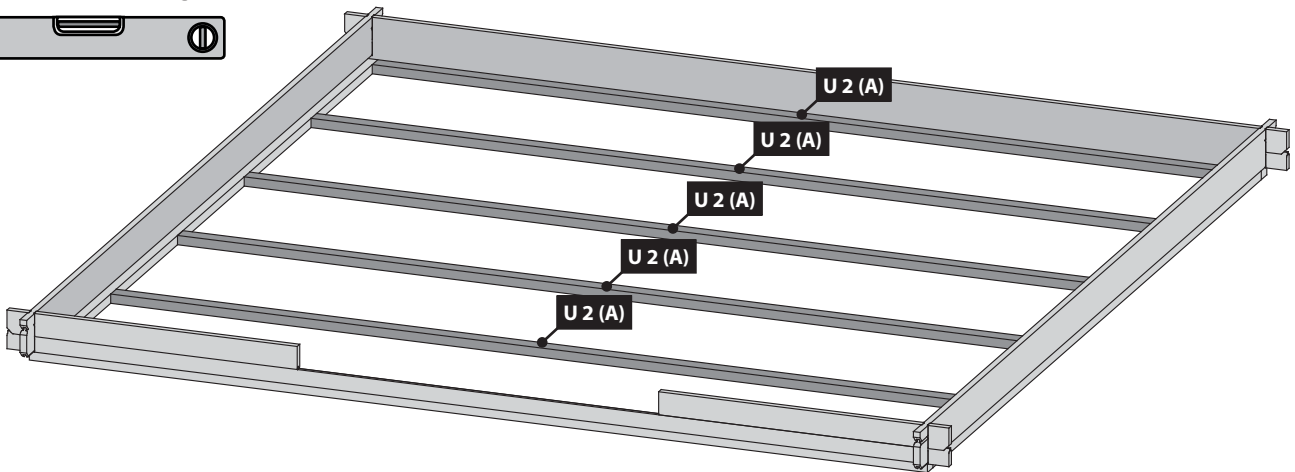
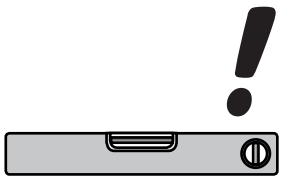
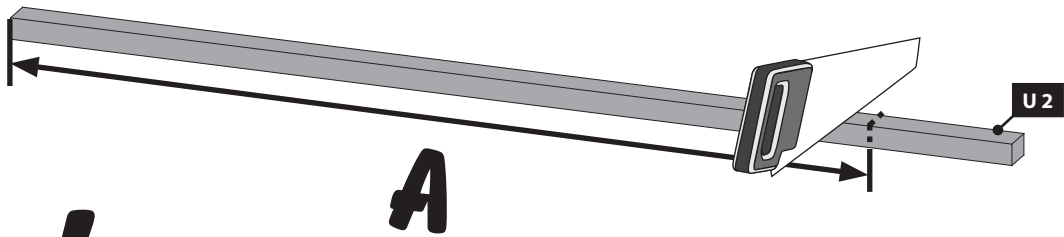
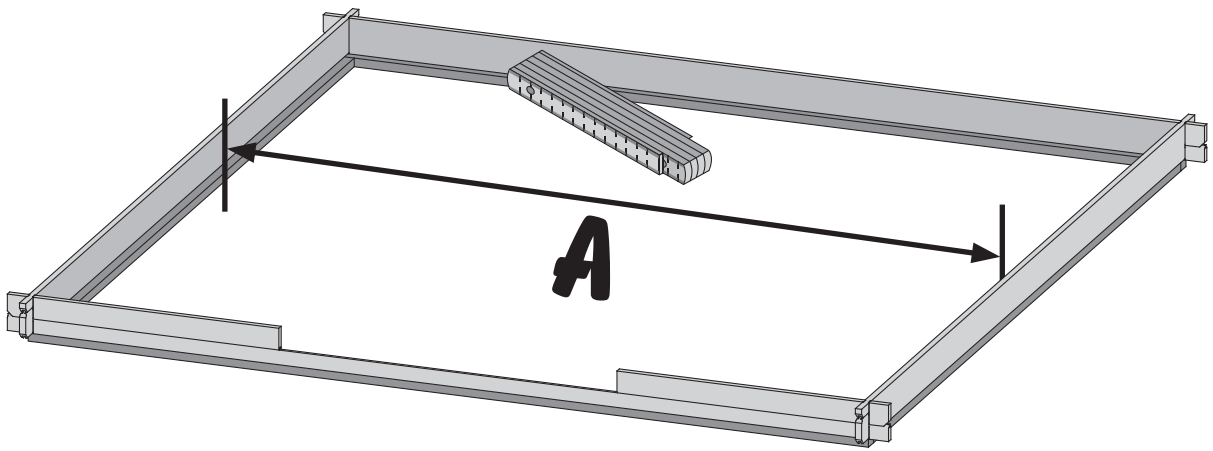

**!!! B=B=B=B=B !!!**

-  Draufsicht
-  Top view
-  vue de dessus
-  bovenaanzicht

-  vista desde arriba
-  vista desde arriba
-  vista dall'alto
-  púdorýs

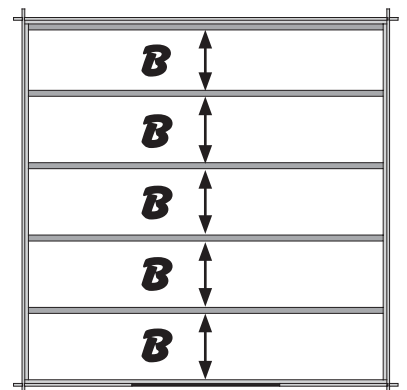

# A

02

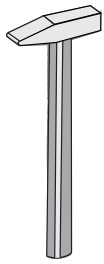

504x

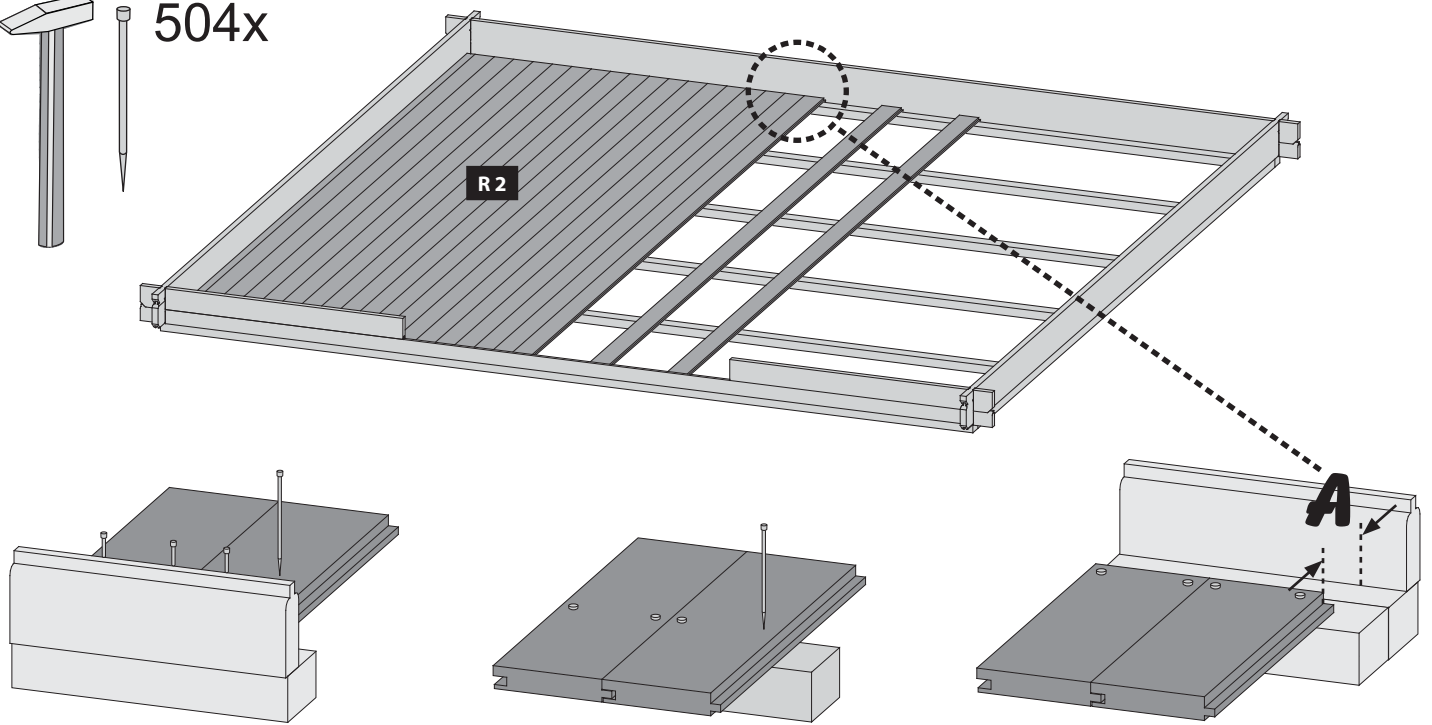

03

-  Bündig!
-  Flush!
-  Affleurement!
-  Gelijk!
-  I flugt!
-  Aras!
-  Combacia!
-  Stejný !

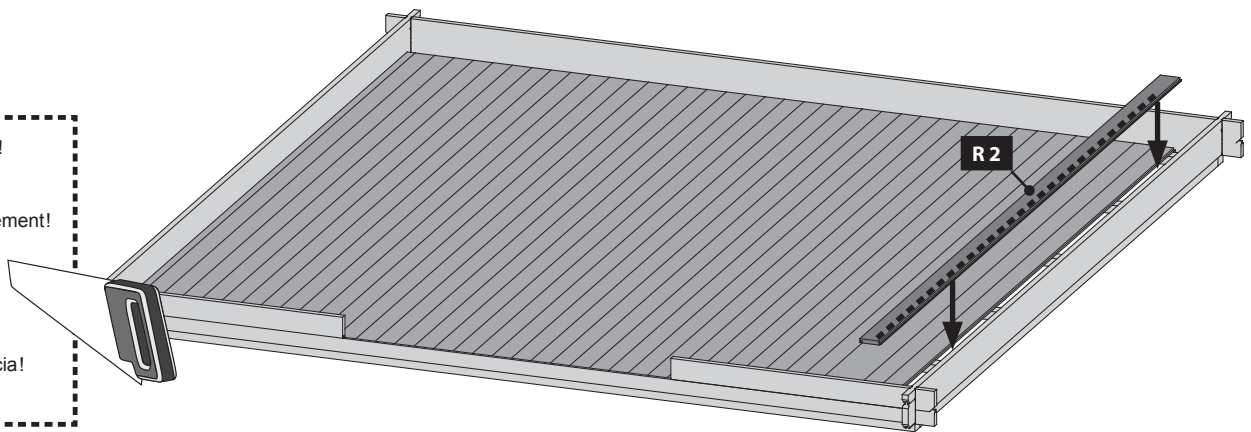

04

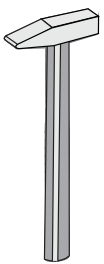

10x

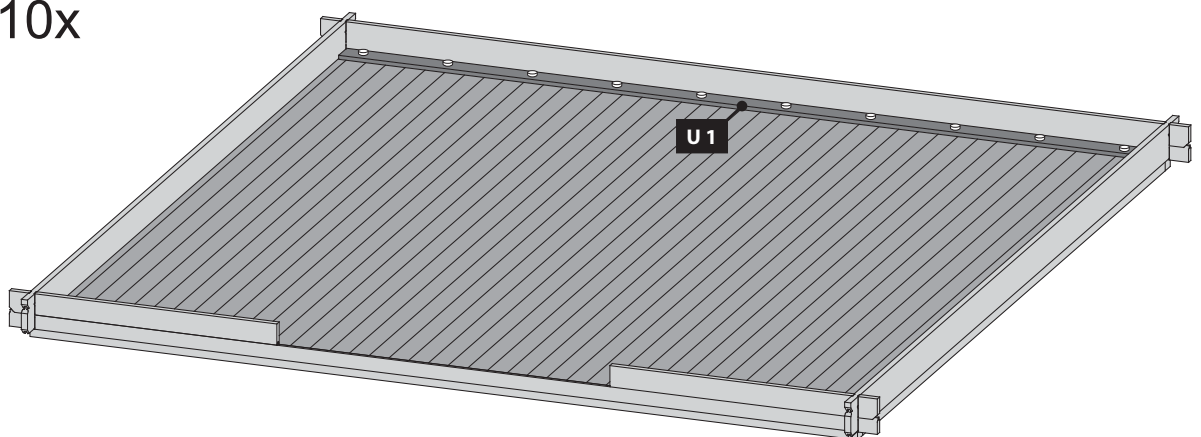

# B

01

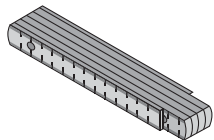
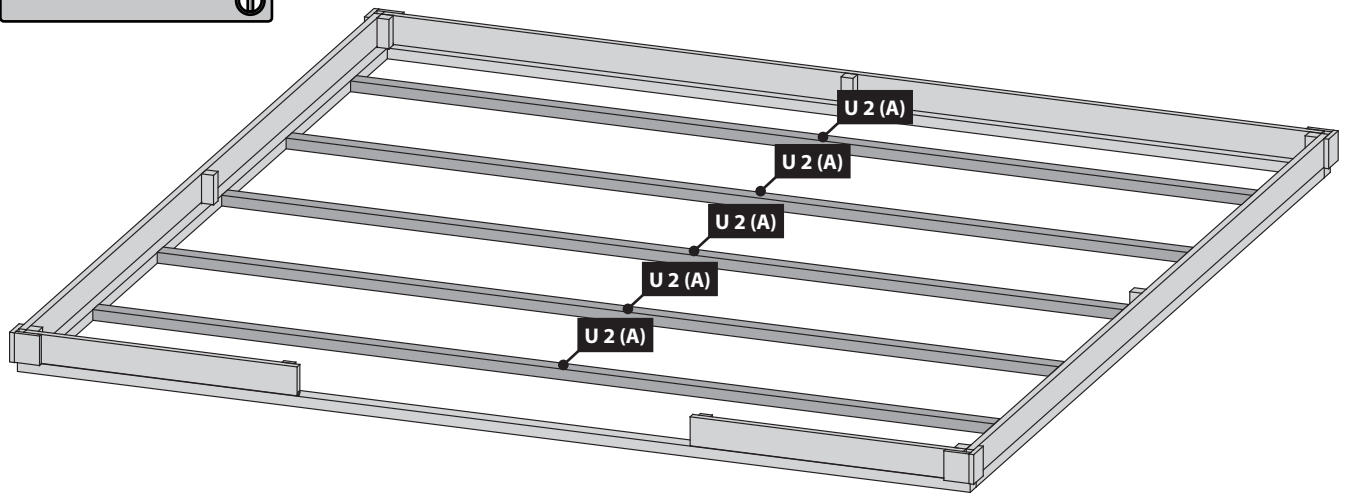
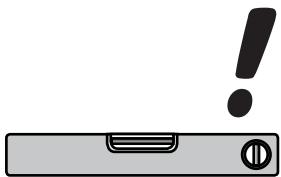
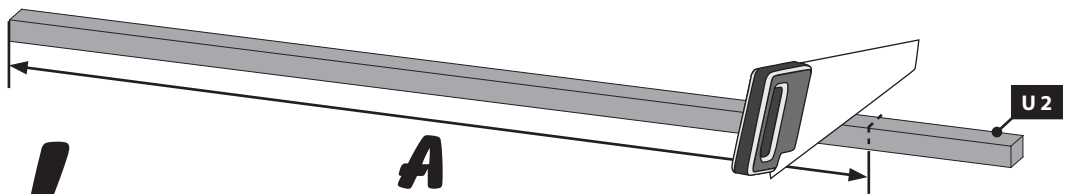
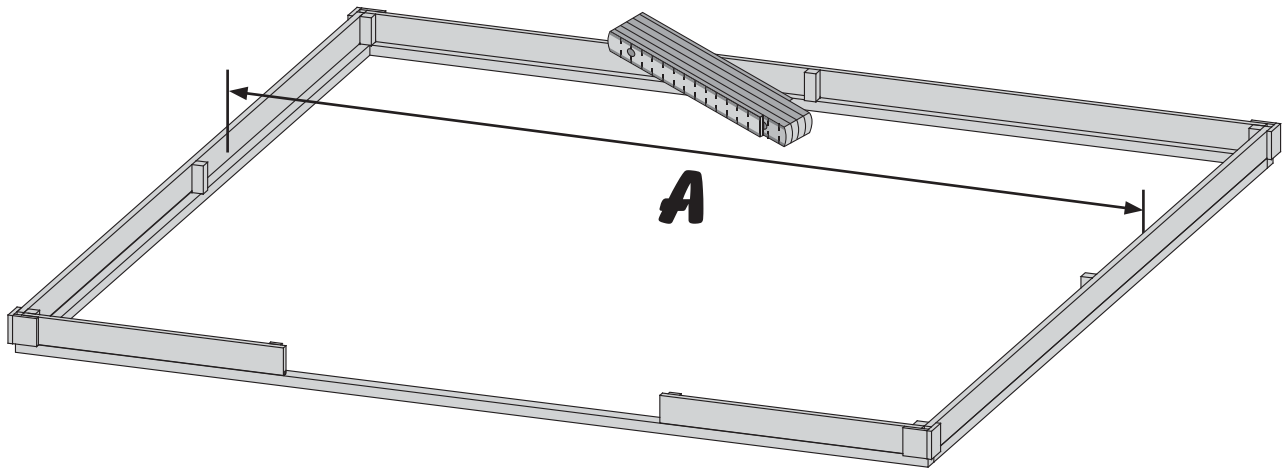

**!!! B=B=B=B=B=B !!!**

-  Draufsicht
-  Top view
-  vue de dessus
-  bovenaanzicht

-  vista desde arriba
-  vista desde arriba
-  vista dall'alto
-  pŕdorys

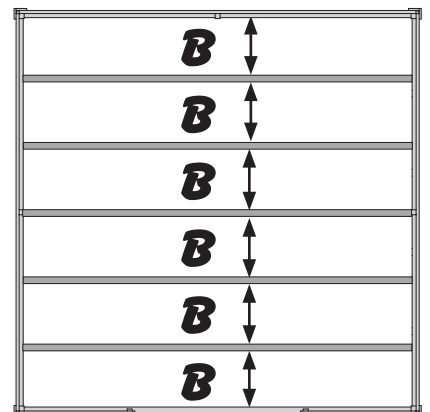

# B



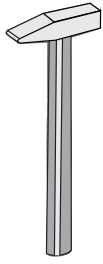

02

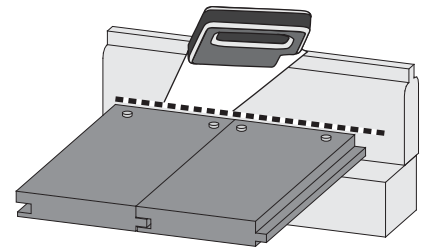
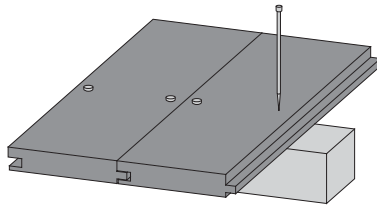
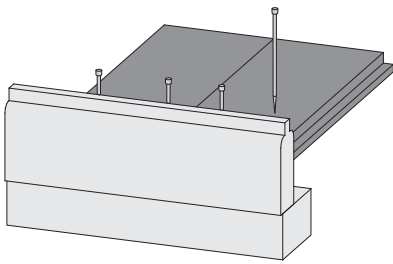
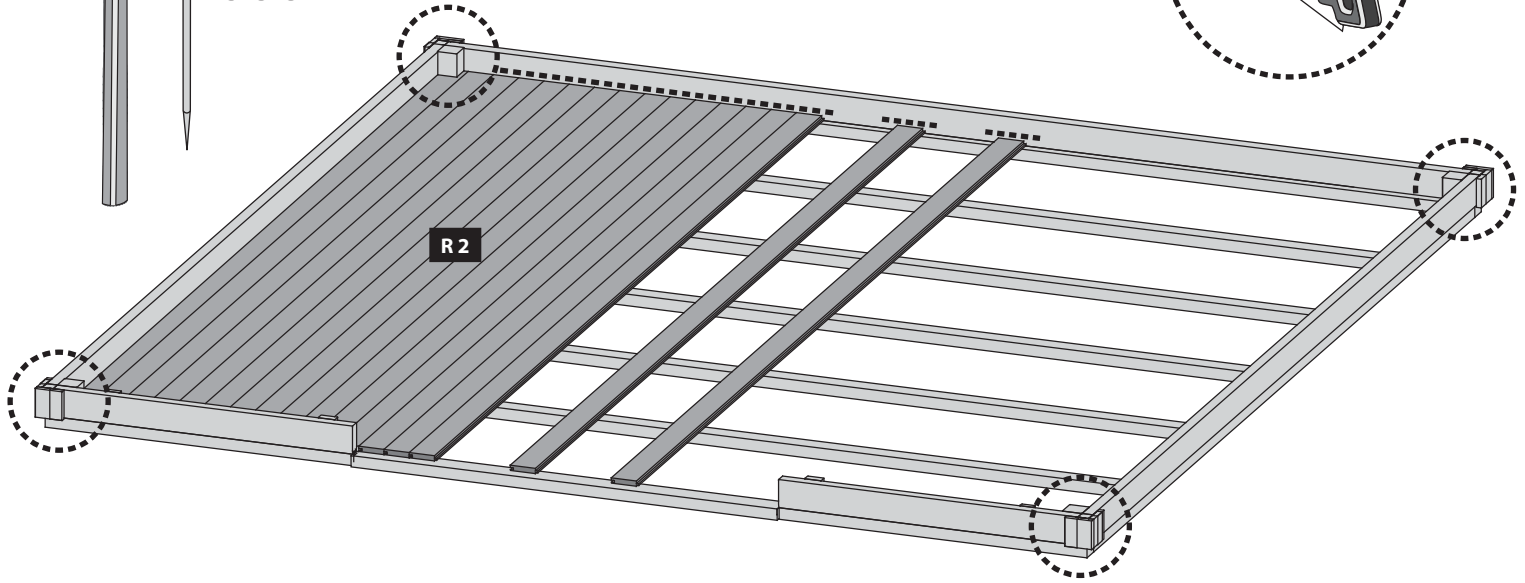
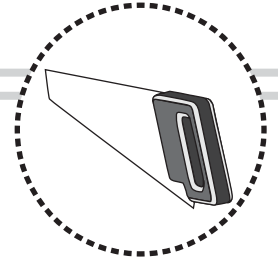

588x



03

-  Bündig!
-  Flush!
-  Affleurement!
-  Gelijk!
-  I flugt!
-  Aras!
-  Combacia!
-  Stejný !

