

# 17944-1

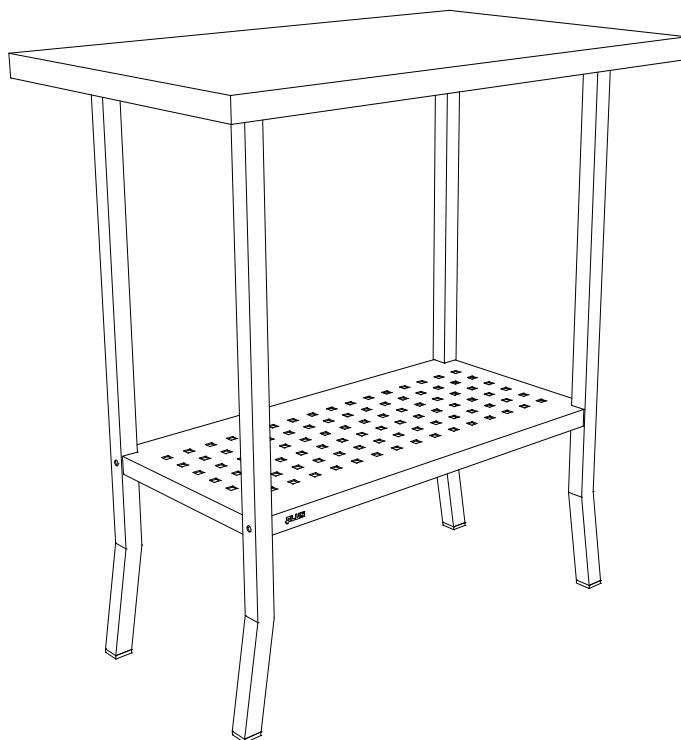

A : 1 stk

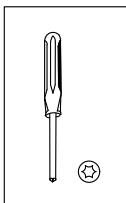
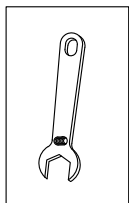
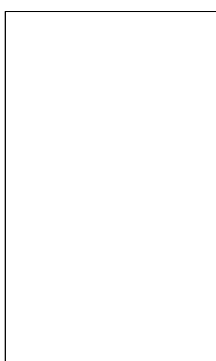

B: 1 stk

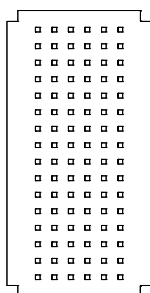

C : 2 stk

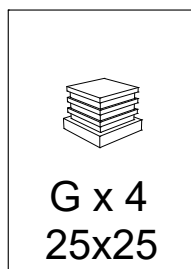
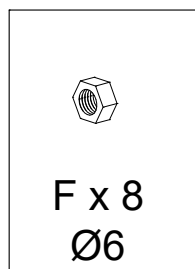
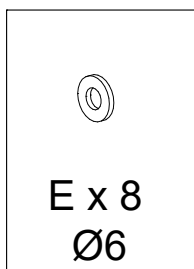
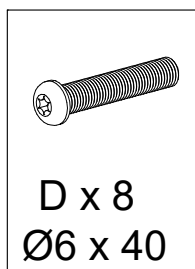
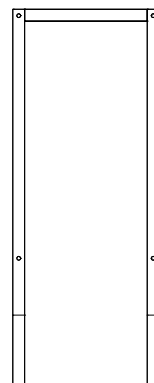

**PLUS**

PLUS A/S  
Ådalen 13B  
DK-6600 Vejen  
phone: +45 7996 3333  
web: [www.plus.dk](http://www.plus.dk)

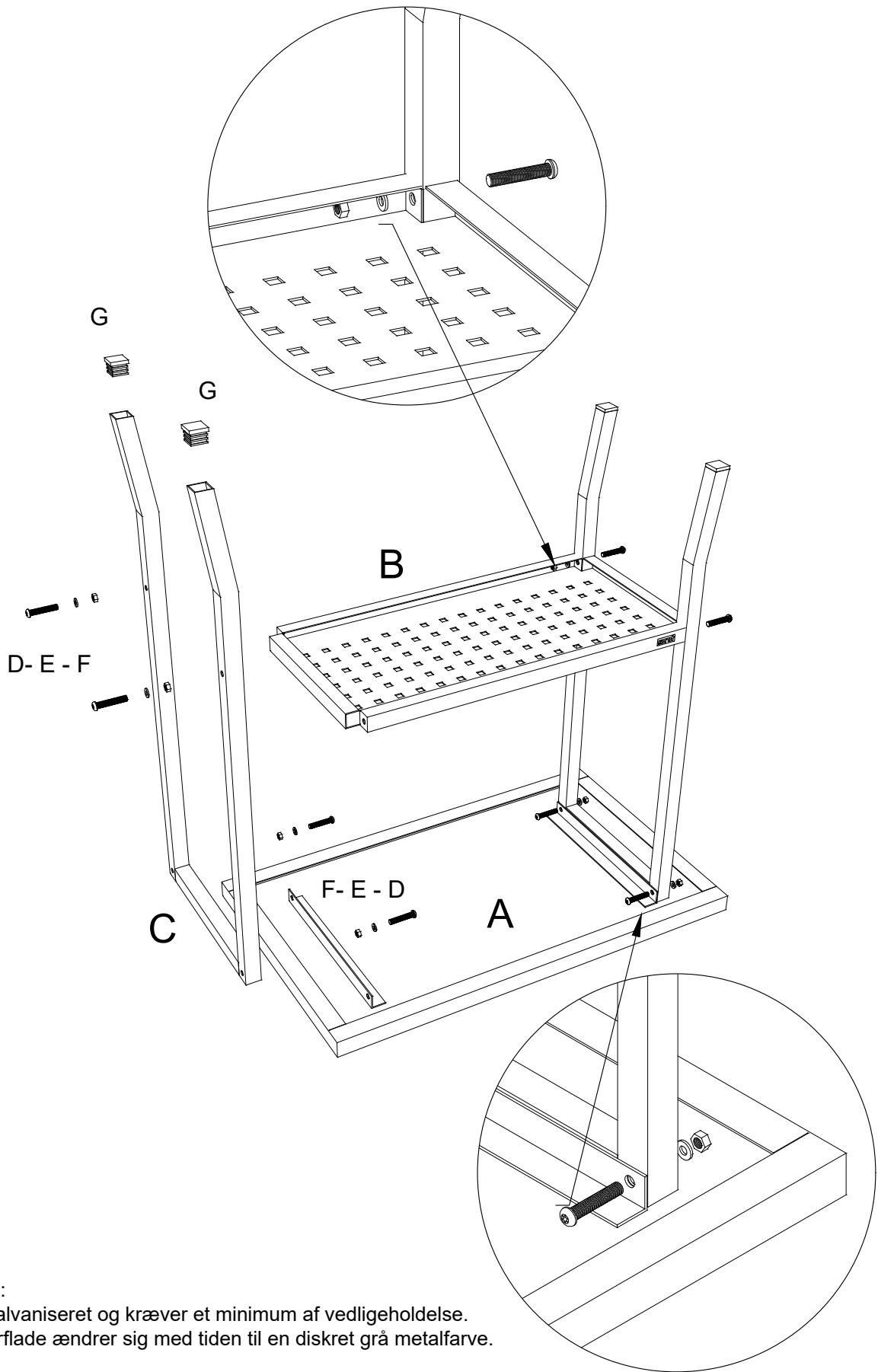

**Vedligeholdelse:**

Stålet er varmgalvaniseret og kræver et minimum af vedligeholdelse.  
Den blanke overflade ændrer sig med tiden til en diskret grå metalfarve.

**Pflegeanleitung:**

Das Stahl sind feuerverzinkt und bedürfen einer minimalen Pflege.  
Die blanke oberfläche ändert sich mit der Zeit zu einer diskreten grauen Metallfarbe.

**Maintenance:**

This steel is hot dip galvanized and requires a minimum of maintenance.  
The shining surface will, in time, change to a discrete gray-metallic colour.