

Duschwanne eckig „Summer“ 80&90

47599165-60194567

49781013-12051354

800 x 800 x 140 mm

900 x 900 x 140 mm



**Aufbauanleitung
Eckduschwanne**



**Istruzioni d'installazione
Piatto doccia angolare**



**Installation Instruction
Square Shower Tub**



**Instructions d'installation
Receveur de douche d'angle**

D: Nachdruck, auch auszugsweise, nicht gestattet! GB: Reproduction, even in extracts, is not permitted! F: Toute reproduction de ce mode d'emploi même par extraits est interdite ! IT: È vietata la riproduzione, anche parziale. NL: Nadruk, ook slechts gedeeltelijk, niet toegestaan!

Anleitung, Nr.: 20160383 719181

**WICHTIG, FÜR SPÄTERE BEZUGNAHME DIESES DOKUMENT
AUFBEWAHREN! SORGFÄLTIG LESEN!**

Bestimmungsgemäßer Gebrauch

- Dieser Artikel ist eine vorgefertigte Einheit zum Duschen.
- Dieser Artikel ist nur zum Einsatz im privaten Bereich bestimmt.



Sicherheitshinweise

- Erstickungs- / Verletzungsgefahr! Lassen Sie Kinder nicht mit der Verpackung spielen. Sie könnten an der Folie ersticken oder sich an der Umverpackung verletzen.
- Achten Sie darauf, dass Kinder keine kleinen Teile, wie z. B. Muttern, Abdeckkappen oder Ähnliches in den Mund nehmen. Sie könnten sie verschlucken und daran ersticken.
- Beschädigungsgefahr! Vor der Montage bitte Montageanleitung genauestens durchlesen und Produkt auf evtl. Transportschäden überprüfen. Gehen Sie bei der Montage des Artikels sorgfältig vor.
- Der Artikel darf nur von fachkundigen Personen montiert werden. Es empfiehlt sich die Montage mit zwei Personen durch zu führen.
- Verletzungsgefahr! Beachten Sie bei der Montage, dass einige Teile scharfe Kanten aufweisen.
- Montieren Sie den Artikel nur an einer geeigneten, massiven Wand.
- Benutzen Sie die Dusche erst 24 Stunden nach dem Abdichten.
- Zum Anschluss der Wanne an die hauseigene Wasserentsorgung sollte ein handelsüblicher Syphon mit einem flexiblen Abwasserschlauch verwendet werden.
- Bei Ersatzteilbestellung (siehe Teileliste) bitte an den Kundenservice wenden.

Pflegehinweise

Für die Reinigung und Pflege verwenden Sie einen Schwamm oder ein weiches Tuch. Die glatte Wannenoberfläche lässt sich mühelos reinigen. Es genügen umweltschonende und sanfte Haushaltsreiniger. Verwenden Sie keinesfalls aggressive oder Lösemittel enthaltende Reinigungsmittel. Benutzen Sie zur Reinigung auf keinen Fall scharfe Gegenstände, Stahlwolle, Chemikalien oder sandhaltige Scheuermittel. Diese führen zu einer Beschädigung der Oberfläche und zu einem Verlust der Garantie. Leichte Kalkbeläge lassen sich mühelos mit etwas Haushaltessig entfernen.

Benötigte Werkzeuge

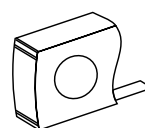
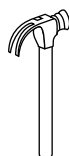
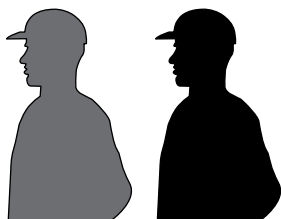
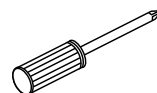
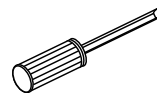
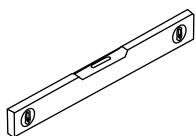
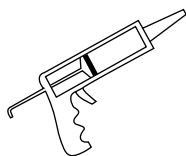

**Aufgrund des hohen Gewichts dieses Produktes
könnte der Aufbau zwei Personen erfordern.**

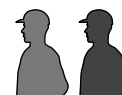

Verpackungsinhalt

[1] 1 x Duschwanne

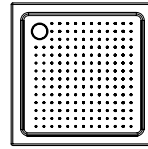

[2] 1 x Siphon-Garnitur



Montagezeichnung

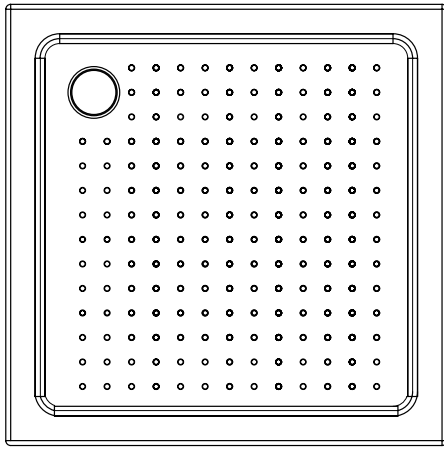

[1]

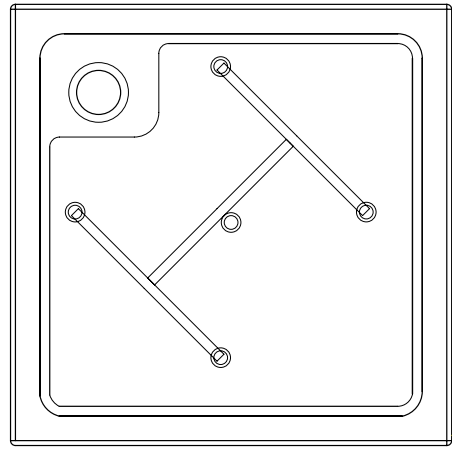

[2]

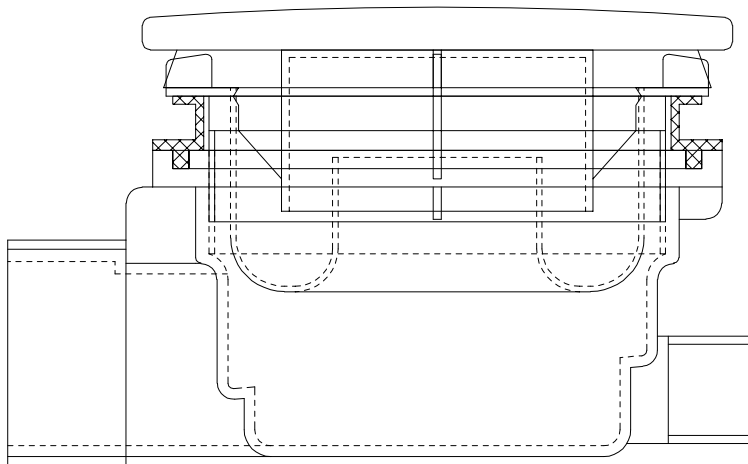

[3]

- [1] 1 Acryl Duschwanne – mit angeschäumtem Wannenträger, 140 mm Höhe
- [2] 5 x höhenverstellbare Füße
- [3] Siphon Garnitur
 - Durchmesser Ablaufloch M85
 - Gewindeanschluss M42 für Abwasserschlauch
 - Flexibler Abwasserschlauch

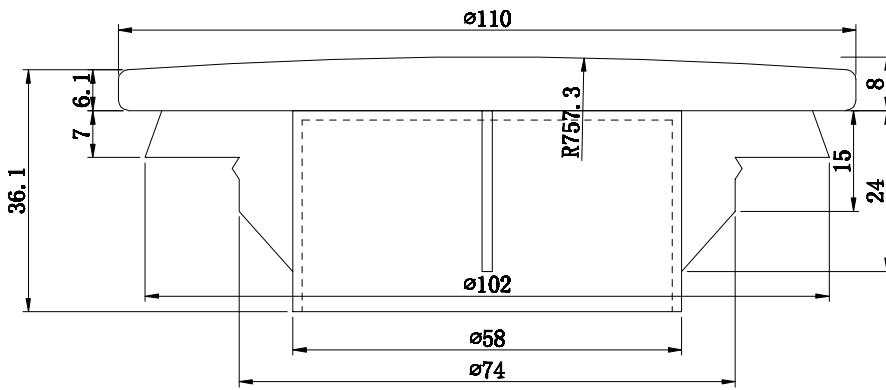

[4]

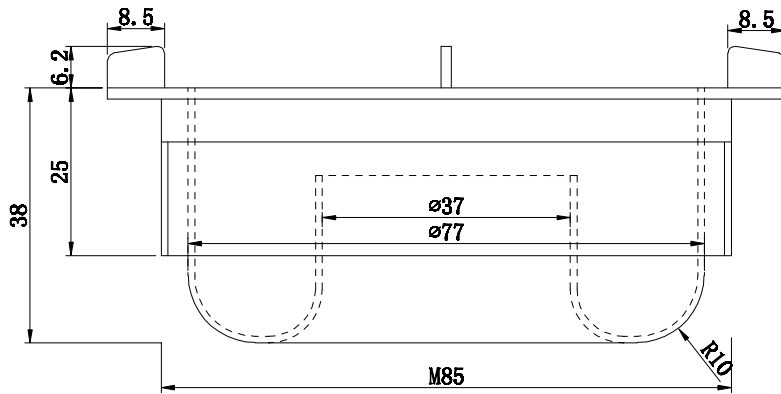

[5]

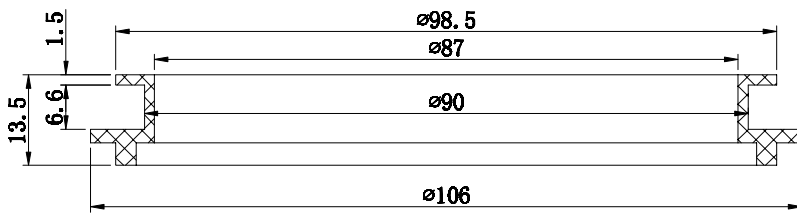

[6]

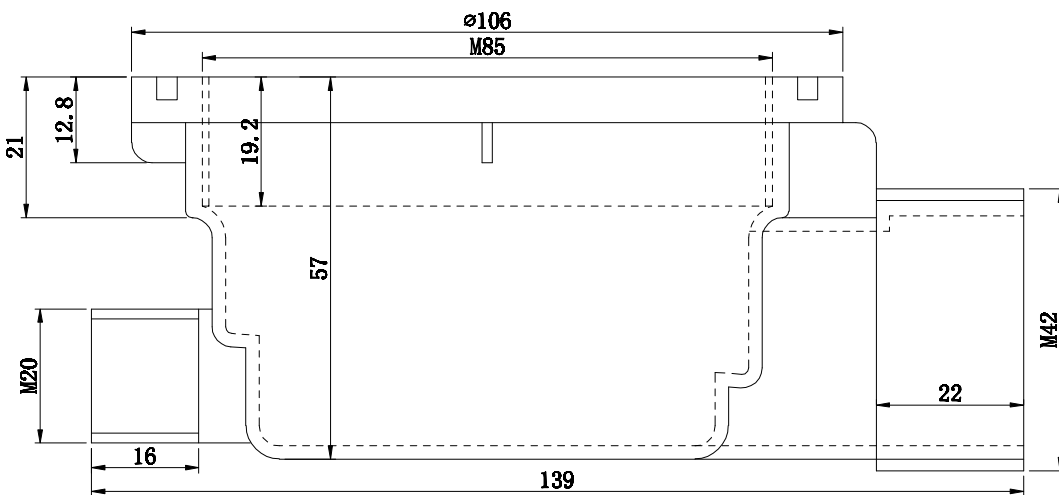

[7]

- [4] Chromabdeckung
- [5] entnehmbarer Reinigungseinsatz
- [6] Ablaufventil
- [7] Siphonkörper

Aufbauschrirte

Schritt 1

- Ausrichten der höhenverstellbaren FüÙe mittels Wasserwaage.
- Im Bereich des Siphons ist bei Erfordernis der Beton leicht auszustemmen.

Schritt 2

- Die Flachdichtung von oben in das Ablaufloch drücken, Siphonkörper [7] von unten an den Abfluss drücken und von oben mit dem Ablaufventil [6] fest drehen.
- Abwasserschlauch mit dem Siphonkörper [7] verbinden und an die hauseigene Wasserentsorgung anschließen.
- Reinigungseinsatz [5] einsetzen, Abdeckung [4] aufdrücken.

Schritt 3

- Die Wanne ist an senkrechten Wänden in einem 90 Grad Winkel auszurichten, mittels einer Wasserwaage.
- Die Fugen sind mit Silikon auszuspritzen. Das Silikon ist entsprechend den eingesetzten Baumaterialien auszuwählen, beachten Sie die Aushärtezeiten.

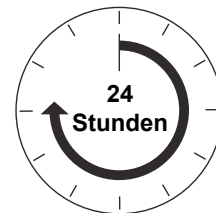
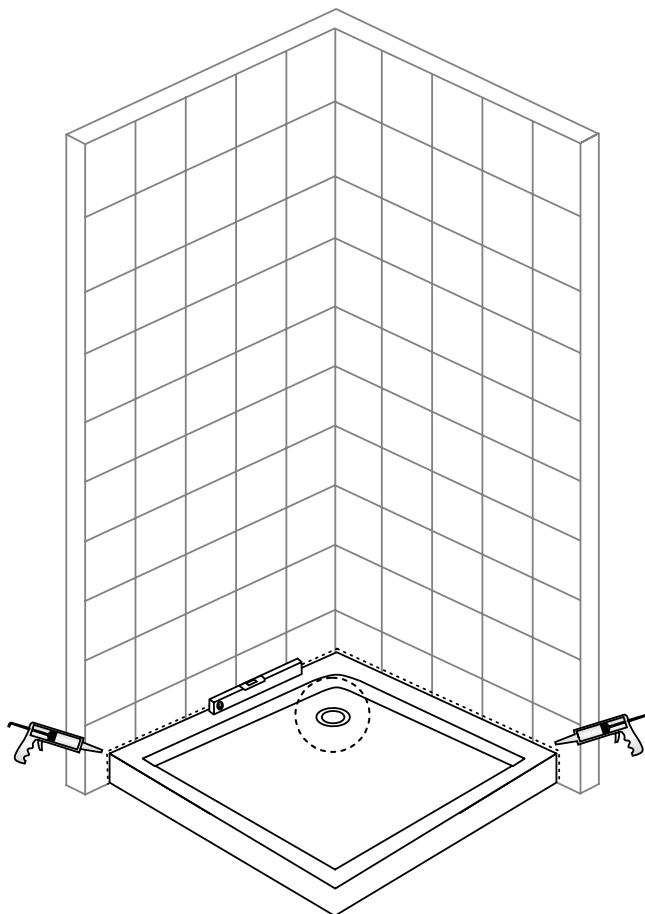

Vor der Erstbenutzung das Silikon
24 Stunden trocknen lassen.

Max. 150 kg

Entsorgung

Sollte dieser Artikel einmal nicht mehr benutzt werden können, so ist jeder Verbraucher gesetzlich verpflichtet, Altgeräte getrennt vom Hausmüll zu entsorgen und z.B. bei einer Sammelstelle seiner Gemeinde / Stadtteils abzugeben.

Unser Service

Eine umgehende Fachberatung erhalten Sie von unserem Service-Team:

- **Deutschland:** Telefon 01806-63 06 30, Festnetz 20ct/Anruf, Mobilfunk max. 60 ct/Anruf
- **Österreich,** Universal: Telefon +43 / 662-4485 59, Festnetz je nach Betreiber, Fachberatung Heimwerken – Otto: +43 / 316-606 159 Festnetz je nach Betreiber, Beratung Heimwerken – Quelle: +43 / 662-9005 59 Festnetz je nach Betreiber, Fachberatung Heimwerken
- **Schweiz,** Quelle: **DE:** +41 / 848 85 85 00, **FR:** +41 / 848 85 85 01, I: +41 / 848 858 530
- Ackermann: DE:** +41 / 848 85 85 11, **FR:** +41 / 848 85 85 21, I: +41 / 848 858 530
- **Niederlande,** call center 0900-1901 (15ct/Min.)

Um Ihnen schnell helfen zu können, nennen Sie uns bitte:

Artikelbezeichnung: Duschwanne eckig „Summer“ 80&90 47599165-60194567

49781013-12051354

und die **Artikelnummer** unter der Sie den Artikel bestellt haben (siehe Rechnung).

Imported by baumarkt direkt GmbH & Co KG, Alter Teichweg 25, D-22081 Hamburg

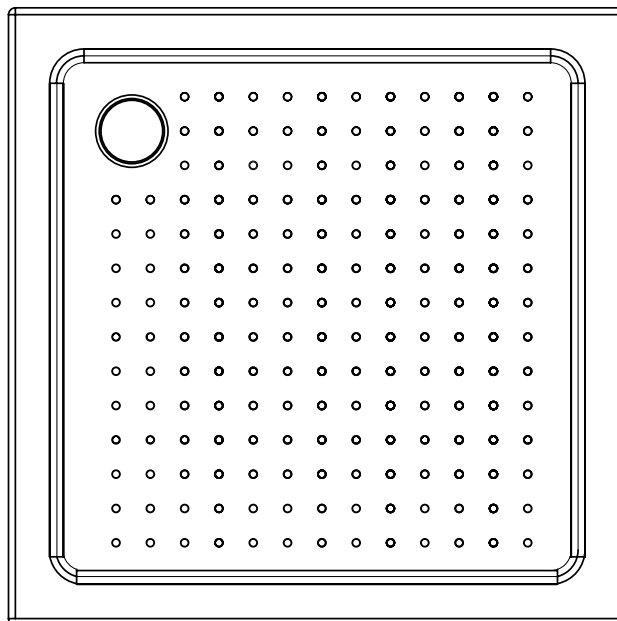

Square Shower Tub „Summer“ 80/90

47599165-60194567

49781013-12051354

800 x 800 x 140 mm

900 x 900 x 140 mm



**Aufbauanleitung
Eckduschanne**



**Istruzioni d'installazione
Piatto doccia angolare**



**Installation Instruction
Square Shower Tub**



**Instructions d'installation
Receveur de douche d'angle**

D: Nachdruck, auch auszugsweise, nicht gestattet! GB: Reproduction, even in extracts, is not permitted! F: Toute reproduction de ce mode d'emploi même par extraits est interdite ! IT: È vietata la riproduzione, anche parziale. NL: Nadruk, ook slechts gedeeltelijk, niet toegestaan!

Instruction No. 20160383 719181

IMPORTANT: PLEASE KEEP THIS DOCUMENT FOR LATER REFERENCE!
READ CAREFULLY!

Indented use

- This product is a prefabricated unit for showering.
- This product is intended for use in private spheres only.



Safety instructions

- Choking hazard / danger of injury! Do not let children play with the packaging. They might suffocate by the wrapping or injure themselves with the packaging cover.
- Make sure that children do not take small parts such as nuts, cover caps or the like into their mouths. They could swallow these and choke on them.
- Risk of damage! Please read the assembly instructions very carefully prior to assembling and check the product for possible transportation damage. Be careful during the product's assembly.
- The product must only be installed by competent persons. The assembly is recommended to be conducted by two people.
- Danger of injury! During the assembly, please consider that some parts have sharp edges.
- Fix product to suitable and solid walls only.
- Do not use shower before lapse of 24 hours after sealing.
- To connect the tub with the own in-house water disposal, a commercial siphon with a flexible sewage hose should be used.
- To order spare parts (see part's list), please contact the customer service.

Maintenance instructions

Use a sponge or a soft cloth for cleaning and care. The smooth tub surface can be cleaned easily. Environmentally friendly and gentle cleaning agents suffice. By no means use any aggressive liquids or cleaning agents containing solvents. Never use sharp objects, steel wool, chemicals or sandy scouring agents for cleaning. These lead to surface damage and loss of warranty. Slight lime deposits are easily removed with some household vinegar.

Tools required

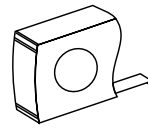
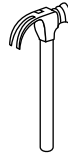
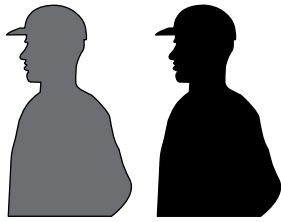
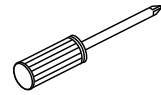
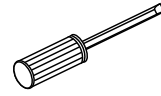
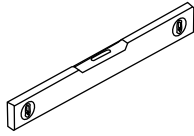
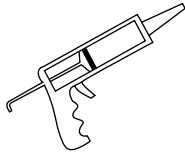

This product is heavy and may require two people to install.

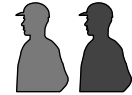

Box contents

[1] 1 x Shower tub

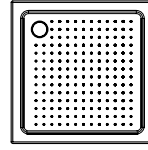

[2] 1 x Siphon set



Assembly drawing

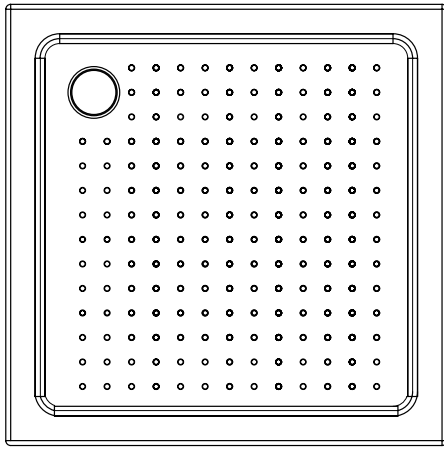

[1]

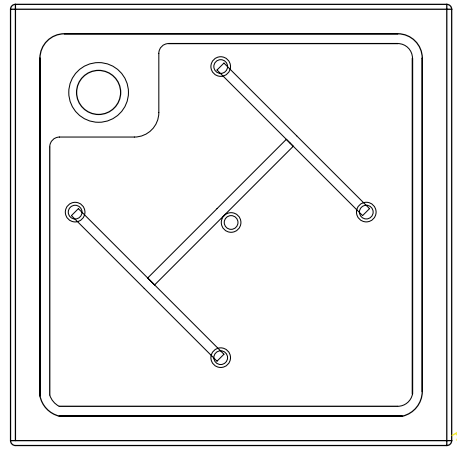

[2]

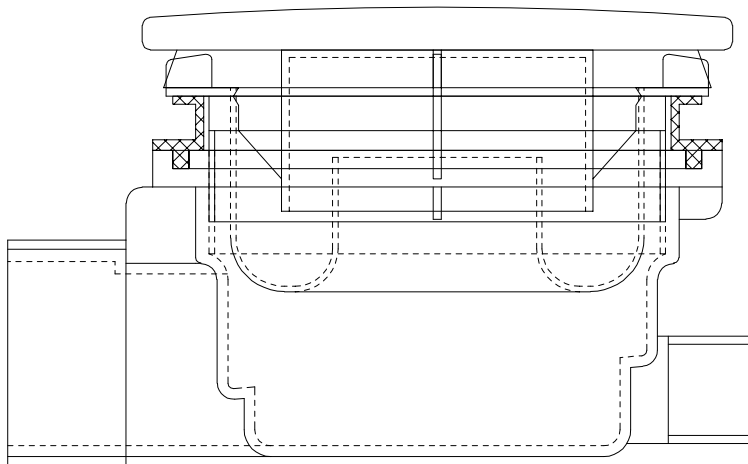

[3]

- [1] 1 Acrylic shower tub - with foam-insulated tub carrier, 140 mm height
- [2] 5 x Height-adjustable feet
- [3] Siphon set
 - Diameter drainage outlet M85
 - Threaded connection M42 for sewage hose
 - Flexible sewage hose

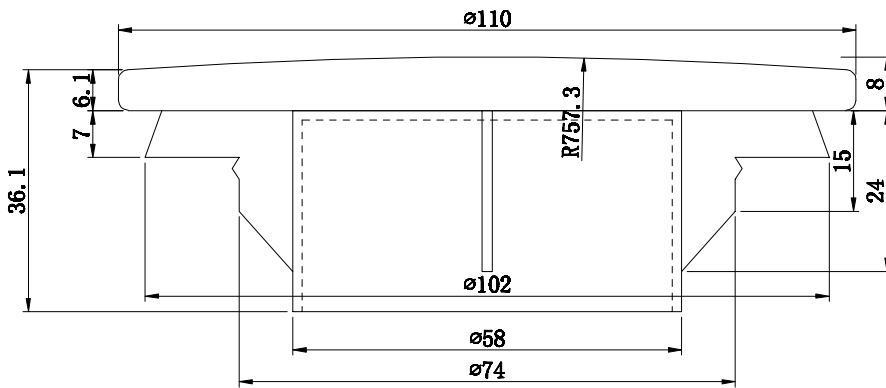

[4]

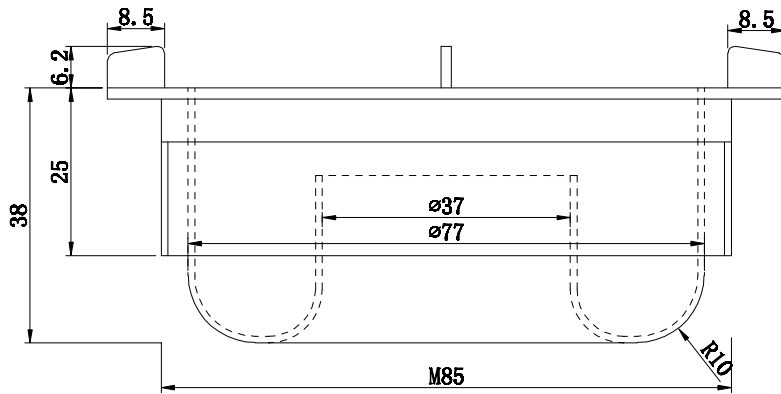

[5]

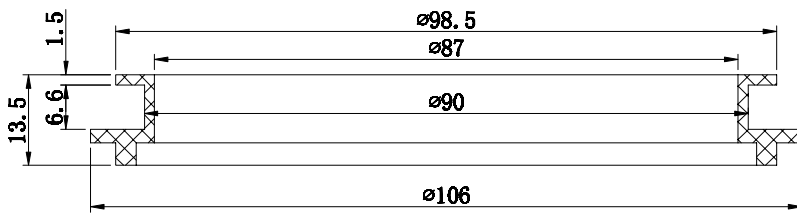

[6]

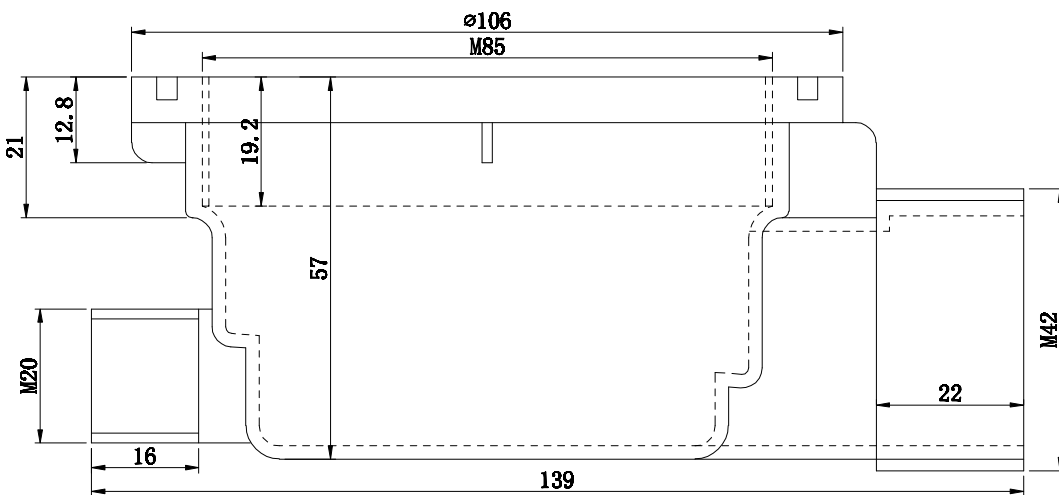

[7]

- [4] Chrome cover
- [5] Removable cleaning insert
- [6] Drainage valve
- [7] Siphon body

Installation steps

Step 1

- Alignment of height-adjustable feet with spirit level.
- Slightly carve off concrete in siphon area, if necessary.

Step 2

- Press the flat seal from above into the drainage outlet, press siphon body [7] from below onto the drain and fasten tightly with the drainage valve [6] from above.
- Connect the sewage hose to the siphon body [7] and connect with in-house sewage system.
- Insert cleaning bit [5], press the cover [4] on.

Step 3

- The tub is to be aligned with vertical walls in a 90 degree angle by means of a spirit level.
- The joints are to be filled with silicone. Select type of silicone in accordance with construction material used. Please mind curing times.

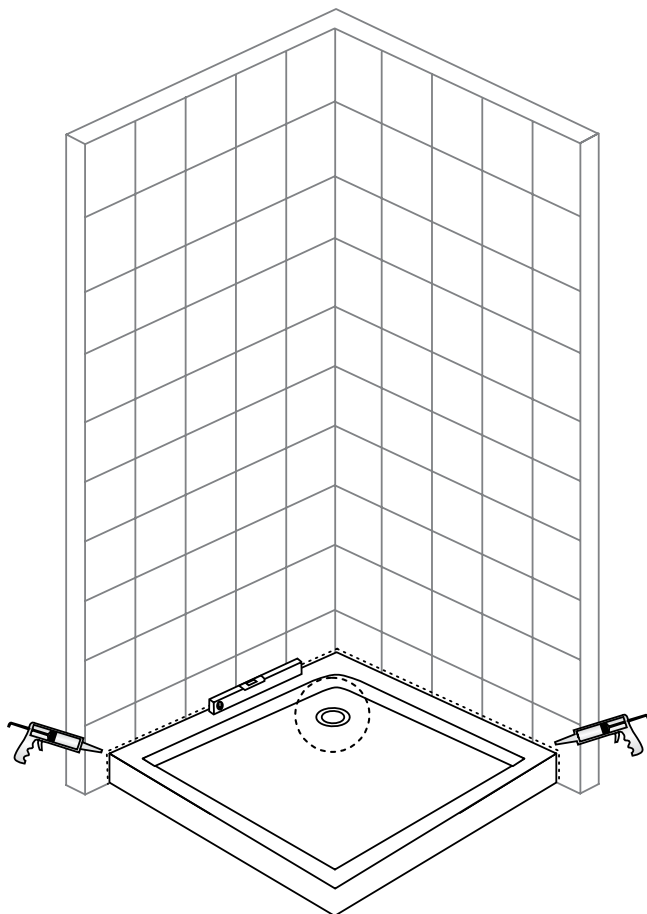

Allow 24 hours for silicone to dry before first use.

Max. 150 kg

Disposal

Should the product no longer be serviceable, every consumer has a statutory obligation to dispose of old appliances separately from domestic waste and dispose of them e.g. at a local authority / district collection point.

Our service

You will receive prompt professional advice from our service team:

- **Germany:** Telephone 01806-63 06 30, Land line 20ct/call, mobile telephone connection 60ct/call max.
- **Austria, Universal:** Telephone +43 / 662-4485 59 landline depending on provider, Home improvement expert service - Otto: +43 / 316-606 159 landline depending on provider, Home improvement expert service - Quelle: +43 / 662-9005 59 landline depending on provider, Home improvement expert service
- **Switzerland, Quelle:** **DE:** +41 / 848 85 85 00, **FR:** +41 / 848 85 85 01, **I:** +41 / 848 858 530
Ackermann: DE: +41 / 848 85 85 11, **FR:** +41 / 848 85 85 21, **I:** +41 / 848 858 530
- **The Netherlands:** call center 0900-1901 (15ct/min.)

In order to assist you more efficiently, please tell us the:

Product designation: Duschwanne eckig „Summer“ 80/90 47599165-60194567

49781013-12051354

and **item number** you used to order the item (see invoice).

Imported by baumarkt direkt GmbH & Co KG, Alter Teichweg 25, D-22081 Hamburg

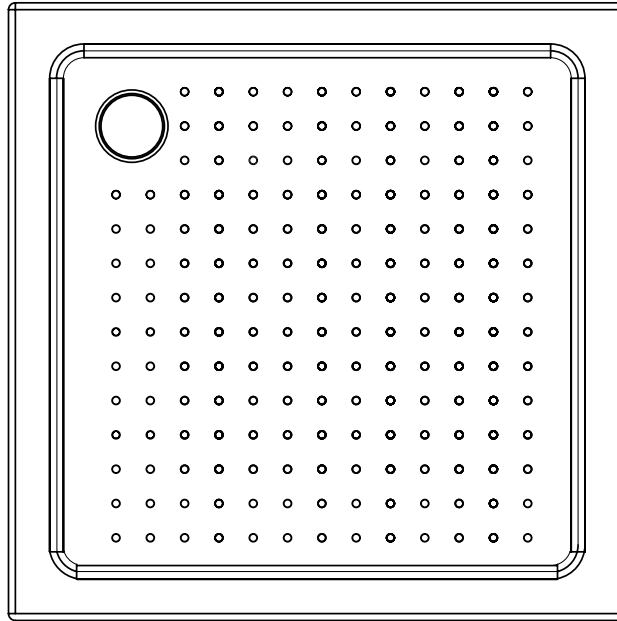

Receveur de douche d'angle "Summer" 80/90

47599165-60194567

49781013-12051354

800 x 800 x 140 mm

900 x 900 x 140 mm



**Aufbauanleitung
Eckduschwanne**



**Istruzioni d'installazione
Piatto doccia angolare**



**Installation Instruction
Square Shower Tub**



**Instructions d'installation
Receveur de douche d'angle**

D: Nachdruck, auch auszugsweise, nicht gestattet! GB: Reproduction, even in extracts, is not permitted! F: Toute reproduction de ce mode d'emploi même par extraits est interdite ! IT: È vietata la riproduzione, anche parziale. NL: Nadruk, ook slechts gedeeltelijk, niet toegestaan!

Instruction No. 20160383 719181

**IMPORTANT, CONSERVER CE DOCUMENT POUR TOUTE RÉFÉRENCE
ULTÉRIEURE ! À LIRE ATTENTIVEMENT !**

Utilisation conforme à la destination

- Cet article est un ensemble de douche préfabriqué.
- Cet article n'est destiné qu'à un usage de type privé.



Avis de sécurité

- Risque d'étouffement / de blessure ! Ne laissez pas les enfants jouer avec l'emballage car ils pourraient s'étouffer avec le film ou se blesser avec les matériaux d'emballage.
- Veillez à ce que les enfants ne portent pas à la bouche de petits éléments comme les écrous, rondelles de couverture ou autres. Ils pourraient les avaler et s'étouffer avec.
- Risque de dégradations ! Avant le montage, merci de lire très attentivement les instructions de montage et de vérifier que le produit n'a pas été endommagé au cours du transport. Merci de procéder au montage de l'article avec de grandes précautions.
- L'article ne peut être assemblé que par du personnel compétent. Il est conseillé de procéder au montage à deux personnes.
- Risque de blessure ! Lors du montage, prenez en compte le fait que le produit présente plusieurs arêtes vives.
- Ne montez l'article que contre des murs massifs et adaptés.
- N'utilisez la douche que 24 heures après l'application de la silicone.
- Pour le raccordement du receveur de douche au système d'évacuation des eaux domestiques, un siphon classique doté d'un tuyau d'évacuation d'eau flexible doit être utilisé.
- Merci de contacter le service clientèle pour toute commande de pièces détachées (voir la liste des pièces).

Instructions d'entretien

Pour le nettoyage et l'entretien, utilisez une éponge ou un chiffon doux. La surface brillante du receveur de douche se nettoie sans effort, un nettoyant ménager doux et respectueux de l'environnement suffit. N'utilisez jamais de produits de nettoyage agressifs ou contenant des solvants. Pour le nettoyage, n'utilisez jamais d'objets pointus, de laine métallique, de produits chimiques ou de produits à récurer contenant du sable. Ils entraîneront une dégradation de la surface et une privation de la garantie. Les dépôts légers de calcaire peuvent être éliminés sans efforts avec un peu de vinaigre de cuisine.

Outils nécessaires

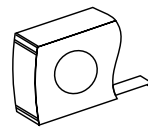
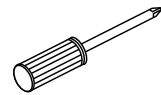
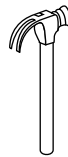
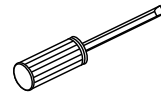
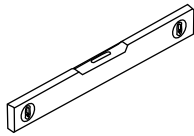
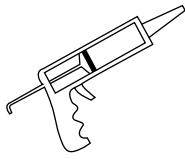

**En raison du poids important de ce produit,
le montage peut nécessiter deux personnes.**



Contenu de l'emballage

[1] 1 x receveur de douche

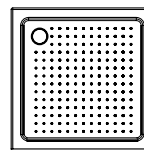

[2] 1 x garniture de



Dessin d'assemblage

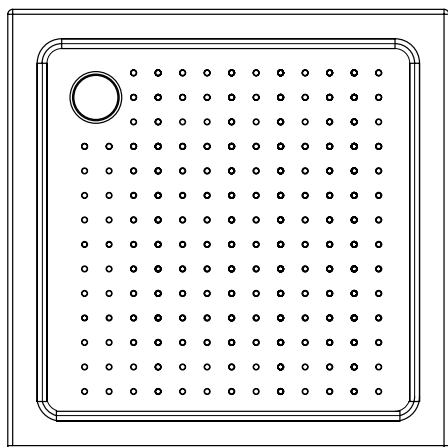

[1]

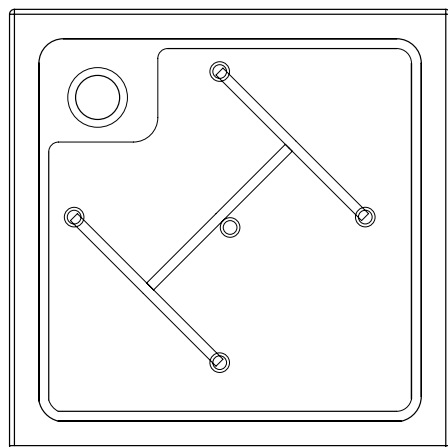

[2]

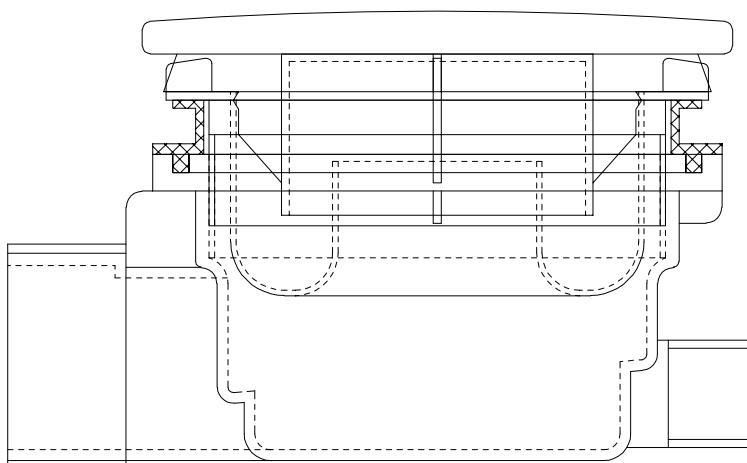

[3]

- [1] receveur de douche acrylique avec support de receveur en mousse, 140 mm de hauteur
- [2] 5 x pieds réglables en hauteur
- [3] Garniture de siphon
 - Diamètre du trou d'évacuation M85
 - Raccordement fileté M42 pour tuyau d'évacuation
 - Tuyau d'évacuation souple

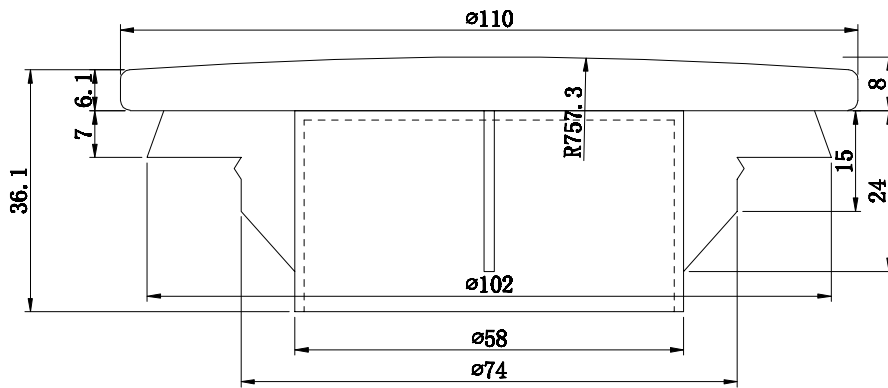

[4]

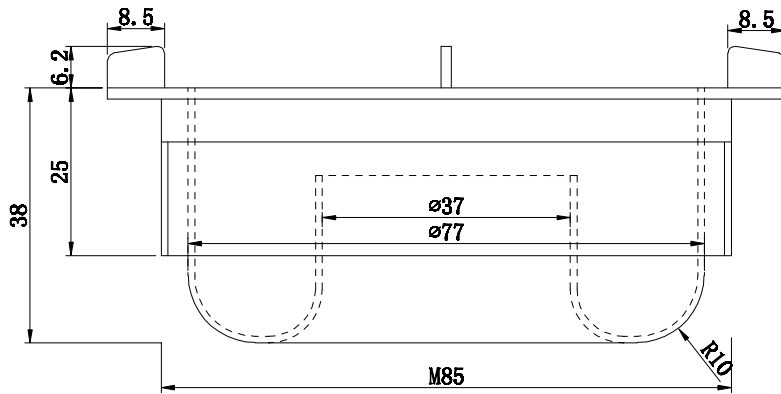

[5]

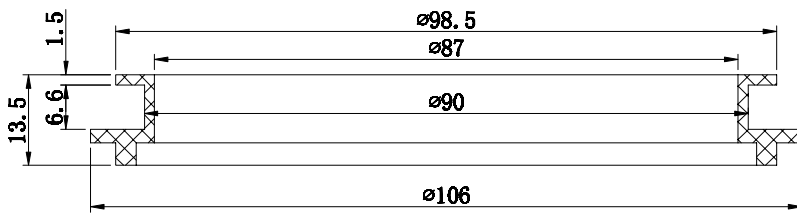

[6]

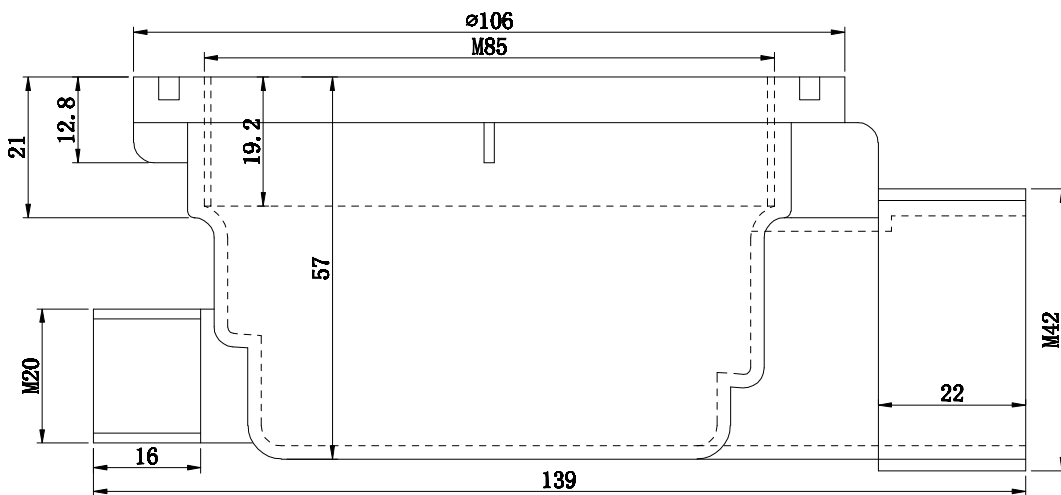

[7]

- [4] couverture chrome
- [5] élément d'épuration amovible
- [6] Valve d'évacuation
- [7] Corps du siphon

Étapes de construction

Étape 1

- Disposition des pieds réglables en hauteur au moyen d'un niveau à bulle.
- En cas de besoin, le béton dans le périmètre du siphon peut être légèrement mortaisé.

Étape 2

- Pousser le joint plat verticalement de haut en bas dans le trou d'évacuation, presser le corps de siphon (7) sur l'évacuation par en dessous et visser fermement la valve d'évacuation (6) au-dessus.
- Relier le tuyau d'évacuation au corps de siphon (7) et le raccorder au système d'évacuation des eaux domestiques.
- Insérer l'élément d'épuration (5), enclencher l'élément de couverture (4).

Étape 3

- Le receveur doit être placé à un angle de 90 ° avec les murs verticaux à l'aide d'un niveau à bulle.
- Les joints doivent être traités à la silicone. La silicone doit être choisie en fonction des matériaux de construction utilisés et le temps de durcissement doit être respecté.

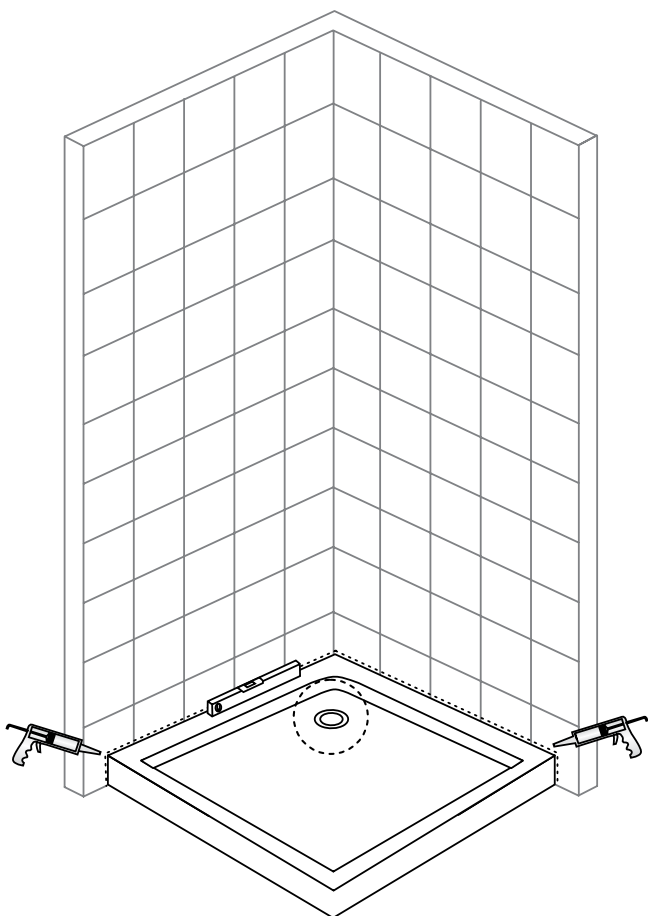

Laisser sécher la silicone 24 heures avant la première utilisation.

Max. 150 kg

Traitement des déchets

Si cet article devient inutilisable, chaque utilisateur est légalement obligé de traiter les vieux appareils ménagers séparément des déchets domestiques, par exemple en les déposants dans un lieu de collecte de sa commune / de son quartier.

Notre service

Vous pourrez bénéficier immédiatement de conseils techniques en contactant notre équipe de services :

- **Allemagne** : téléphone 01806-63 06 30, depuis un poste fixe 20 c/appel, depuis un mobile
- **Autriche** : Universal: téléphone +43 / 662-4485 59, depuis un poste fixe en fonction de l'opérateur, conseil spécialisé bricolage – Otto: +43 / 316-606 159 depuis un poste fixe en fonction de l'opérateur, conseil spécialisé bricolage – Quelle: +43 / 662-9005 59 depuis un poste fixe en fonction de l'opérateur, conseil spécialisé
- **Suisse**, Quelle: **DE**: +41 / 848 85 85 00, **FR**: +41 / 848 85 85 01, I: +41 / 848 858 530
Ackermann: **DE**: +41 / 848 85 85 11, **FR**: +41 / 848 85 85 21, I: +41 / 848 858 530
- **Pays-Bas** : centre d'appel 0900-1901 (15 c/mn)

Pour nous permettre de vous aider aussi rapidement que possible, merci de préciser :

Le nom de l'article : Duschwanne eckig „Summer" 80&90 47599165-60194567

49781013-12051354 et le **numéro d'article** sous lequel vous avez commandé cet article (voir facture).

Importé par baumarkt direkt GmbH & Co KG, Alter Teichweg 25, D-22081 Hamburg

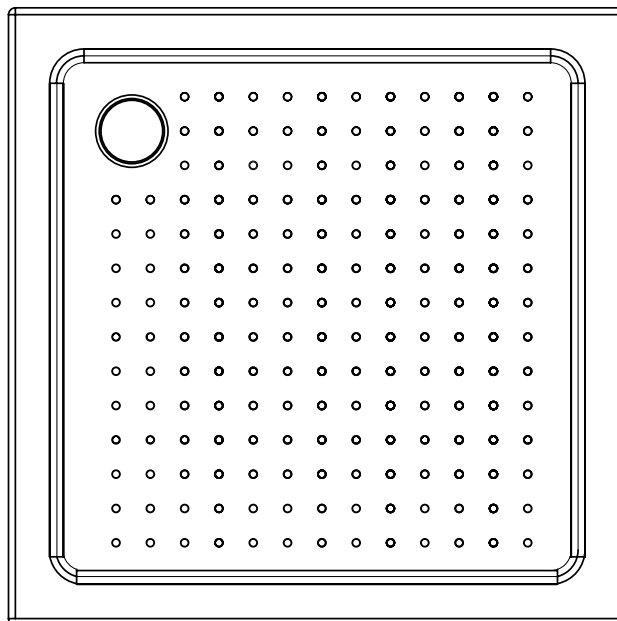

Piatto doccia quadrato "Summer" 80/90

47599165-60194567

49781013-12051354

800 x 800 x 140 mm

900 x 900 x 140 mm



**Aufbauanleitung
Eckduschwanne**



**Istruzioni d'installazione
Piatto doccia angolare**



**Installation Instruction
Square Shower Tub**



**Instructions d'installation
Receveur de douche d'angle**

D: Nachdruck, auch auszugsweise, nicht gestattet! GB: Reproduction, even in extracts, is not permitted! F: Toute reproduction de ce mode d'emploi même par extraits est interdite ! IT: È vietata la riproduzione, anche parziale. NL: Nadruk, ook slechts gedeeltelijk, niet toegestaan!

Istruzione n° 20160383 719181



IMPORTANTE, CONSERVARE IL PRESENTE DOCUMENTO PER UN FUTURO RIFERIMENTO!
LEGGERE CON ATTENZIONE!

Uso conforme

- Il presente articolo è un'unità prefabbricata per la doccia.
- L'articolo è destinato esclusivamente all'uso privato.



Avvisi di sicurezza

- Pericolo di soffocamento / lesioni! L'imballaggio non è un giocattolo per bambini. Potrebbero soffocarsi con la pellicola o ferirsi con l'involucro.
- Fare attenzione che i bambini non mettano in bocca piccole parti quali bulloni, tappi ecc. L'ingerimento potrebbe comportare il soffocamento.
- Pericolo di danneggiamento! Prima del montaggio, leggere attentamente le istruzioni di montaggio e accertarsi dell'assenza di danni da trasporto. Installare l'articolo con la massima cura.
- Il montaggio dell'articolo è consentito solo alle persone esperte. Si consiglia di effettuare il montaggio con l'aiuto di una seconda persona.
- Pericolo di lesioni! Durante il montaggio, fare attenzione ai bordi taglienti di alcune parti.
- Montare l'articolo esclusivamente a ridosso di una parete adatta e massiccia.
- Dopo l'impermeabilizzazione, attendere 24 ore prima dell'utilizzo della doccia.
- Per l'allacciamento della vasca alla rete di scarico, si consiglia di utilizzare un sifone normale con un tubo di scarico flessibile.
- Per ordinare le parti di ricambio (ved. lista dei ricambi) si prega di rivolgersi al servizio clienti.

Avvisi per la pulizia

Per la pulizia si consiglia l'utilizzo di una spugna o di un panno morbido. La superficie liscia della vasca si pulisce facilmente. Sono sufficienti i detersivi ecologici e/o delicati.

Si sconsiglia l'utilizzo di detersivi aggressivi o contenenti solventi.

Non utilizzare oggetti taglienti, lana d'acciaio, agenti chimici o abrasivi contenenti sabbia. Potrebbero danneggiare la superficie e comportare di conseguenza la decadenza della garanzia. Le incrostazioni leggere di calcare si possono rimuovere facilmente con dell'aceto.

Attrezzi necessari

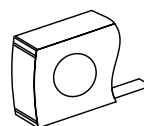
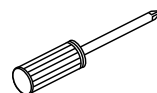
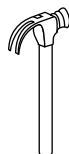
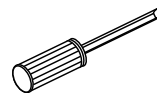
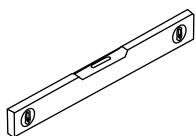
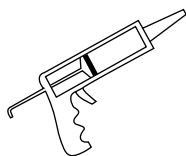

L'elevato peso del prodotto potrebbe rendere necessario l'aiuto di una seconda persona per il montaggio

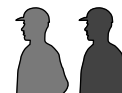

Contenuto della confezione

[1] 1 x piatto doccia

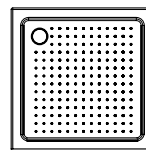

[2] 1 x kit sifone



Schema di montaggio

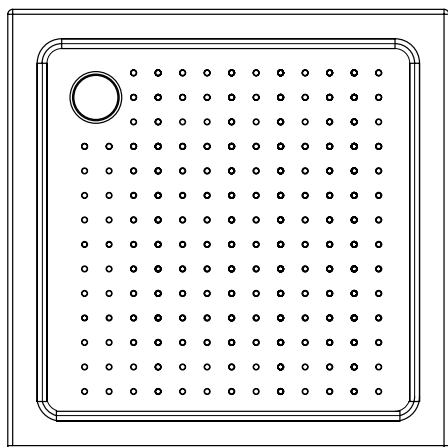

[1]

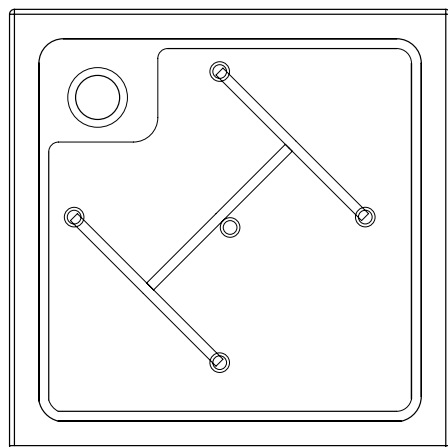

[2]

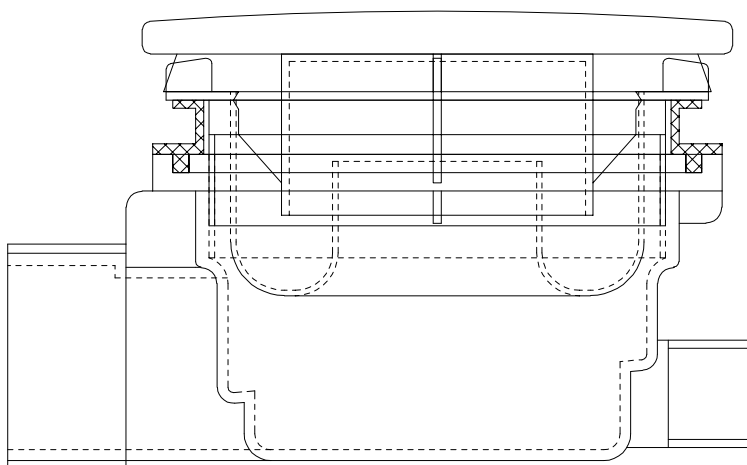

[3]

- [1] 1 piatto doccia acrilico – con portavasca in schiuma espansa, altezza 140 mm
- [2] 5 x piedini regolabili in altezza
- [3] kit sifone
 - diametro foro di scarico M85
 - attacco filettato M42 per tubo di scarico
 - tubo di scarico flessibile

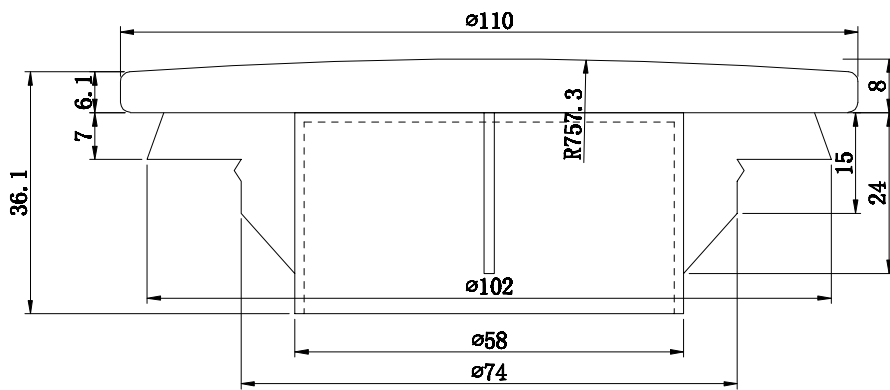

[4]

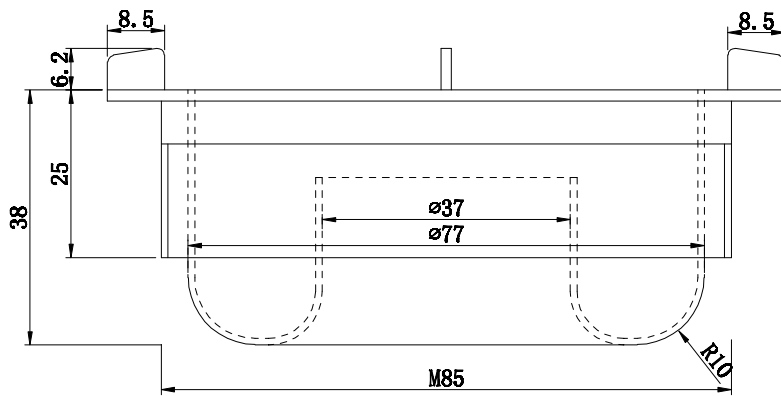

[5]

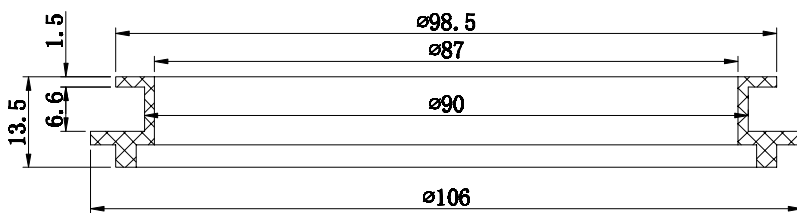

[6]

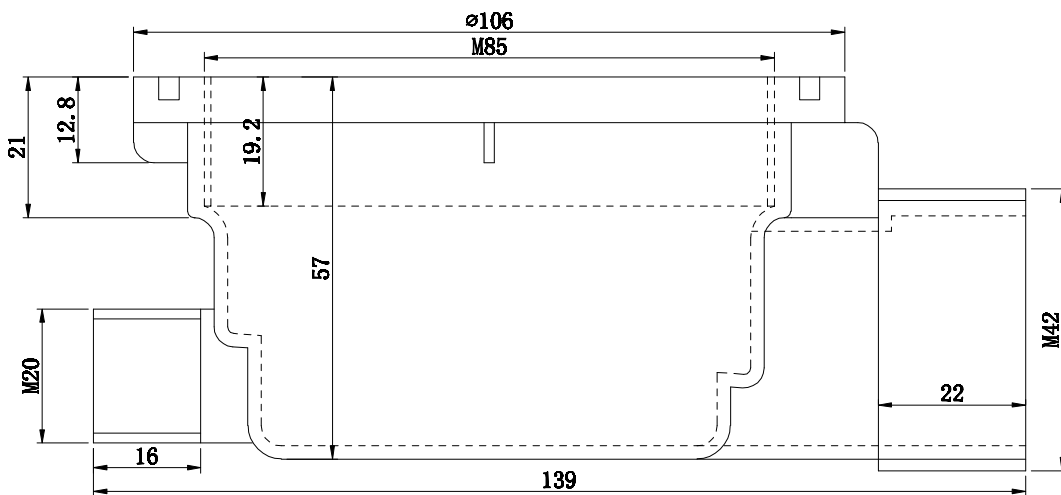

[7]

- [4] copertura cromata
- [5] inserto di pulizia estraibile
- [6] valvola di scarico
- [7] sifone

Fasi di montaggio

Fase 1

- Livellamento dei piedini regolabili con l'aiuto di una bolla
- Ove necessario, mortasare leggermente il cemento nella zona del sifone

Fase 2

- Inserire la guarnizione piatta dall'alto nel foro di scarico, spingere il sifone [7] dal basso sullo scarico avvitandolo dall'alto con la valvola di scarico [6]
- Collegare il tubo di scarico con il sifone [7] allacciandolo alla rete di scarico
- Inserire l'inserito di pulizia [5], posizionare la copertura [4]

Fase 3

- Allineare il piatto doccia alle pareti verticali con un angolo di 90 gradi con l'aiuto di una bolla
- Coprire le giunture con del silicone. Scegliere il silicone in base ai materiali utilizzati; osservare i tempi di indurimento.

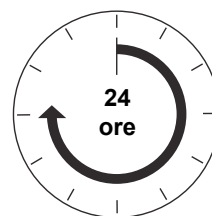
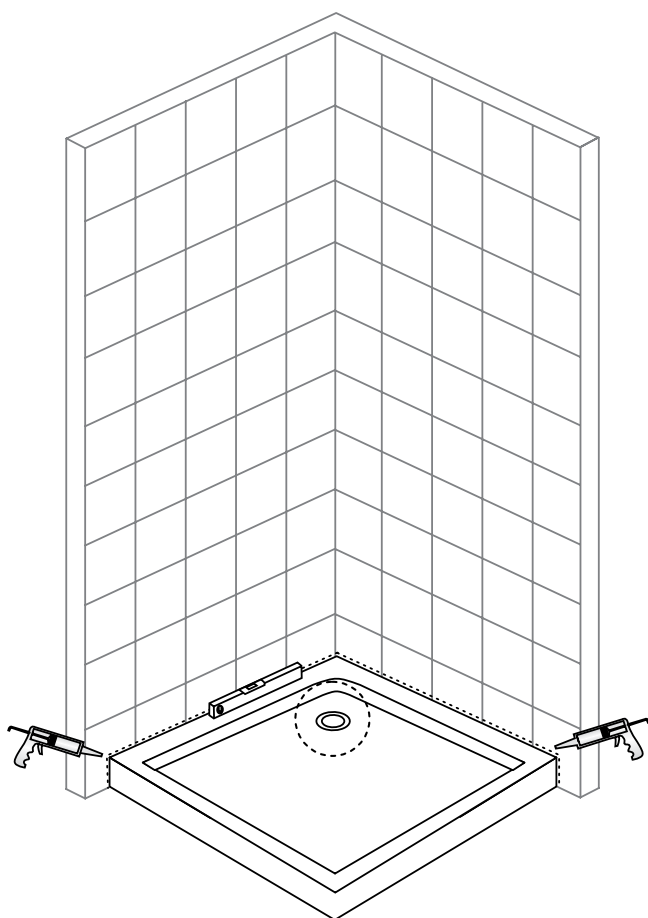

Prima del primo utilizzo, lasciare asciugare il silicone per 24 ore.

Max. 150 kg

Smaltimento

Qualora l'articolo non dovesse più servire, ogni consumatore è obbligato per legge allo smaltimento separato delle vecchie apparecchiature consegnandole ad esempio all'ecocentro del proprio comune / quartiere.

Il nostro servizio

Il nostro team di servizio vi offre una rapida consulenza specialistica:

- **Germania:** telefono 01806-63 06 30, rete fissa 20ct/chiamata, telefonia mobile max. 60 ct/ chiamata
- **Austria, Universal:** telefono +43 / 662-4485 59, rete fissa a secondo del gestore, consulenza specialistica per il fai da te – Otto: +43 / 316-606 159 rete fissa a secondo del gestore, consulenza specialistica per il fai da te – Quelle: +43 / 662-9005 59 rete fissa a secondo del gestore, consulenza specialistica per il fai da te
- **Svizzera, Quelle: DE:** +41 / 848 85 85 00, **FR:** +41 / 848 85 85 01, **I:** +41 / 848 858 530
Ackermann: DE: +41 / 848 85 85 11, **FR:** +41 / 848 85 85 21, **I:** +41 / 848 858 530
- **Paesi bassi,** call center 0900-1901 (15ct/min.)

Per poter garantire un celere aiuto, si prega di indicare:

Il nome dell'articolo: Duschwanne eckig „Summer" 80&90 47599165-60194567

49781013-12051354

e il **codice articolo** con il quale avete ordinato l'articolo (ved. scontrino).

Imported by baumarkt direkt GmbH & Co KG, Alter Teichweg 25, D-22081 Hamburg