

Installation Instruction

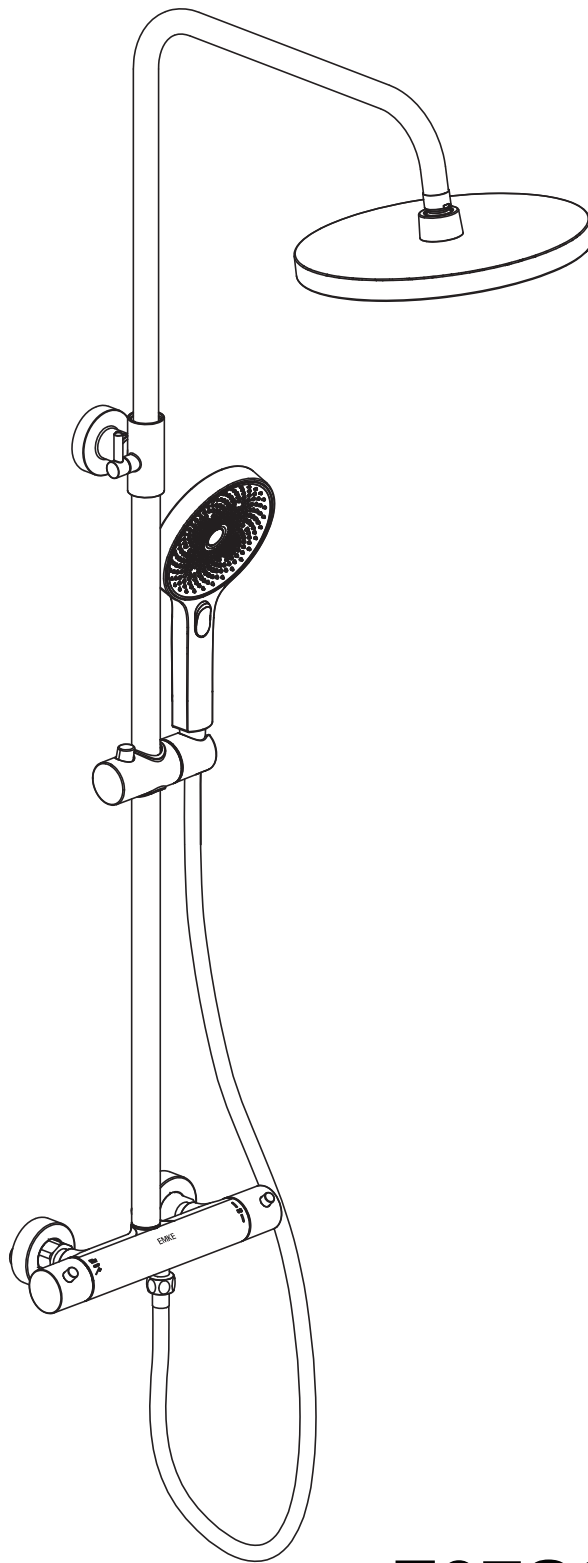

F07SSC00CP

English / Deutsche / Français / Español / Italiano

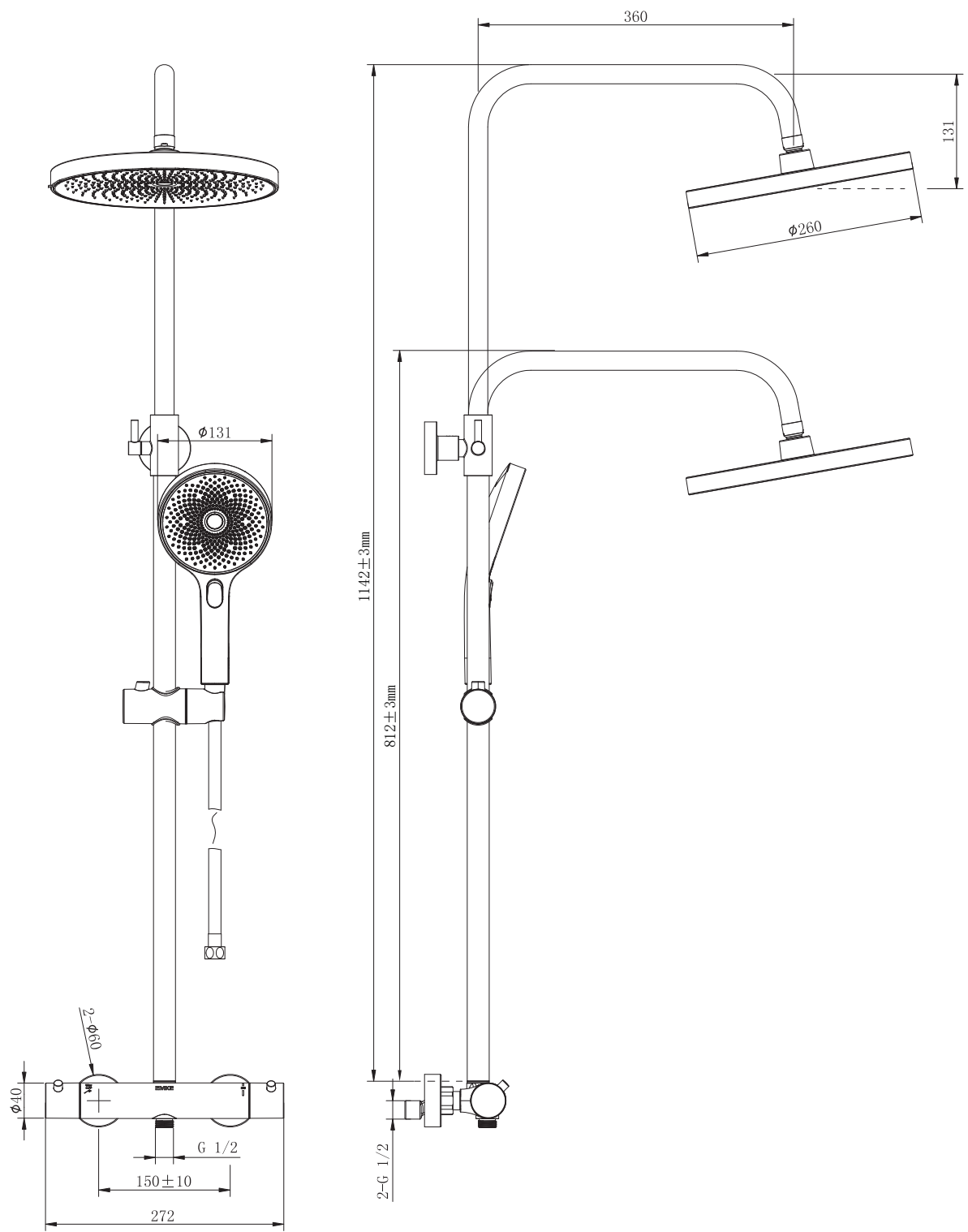

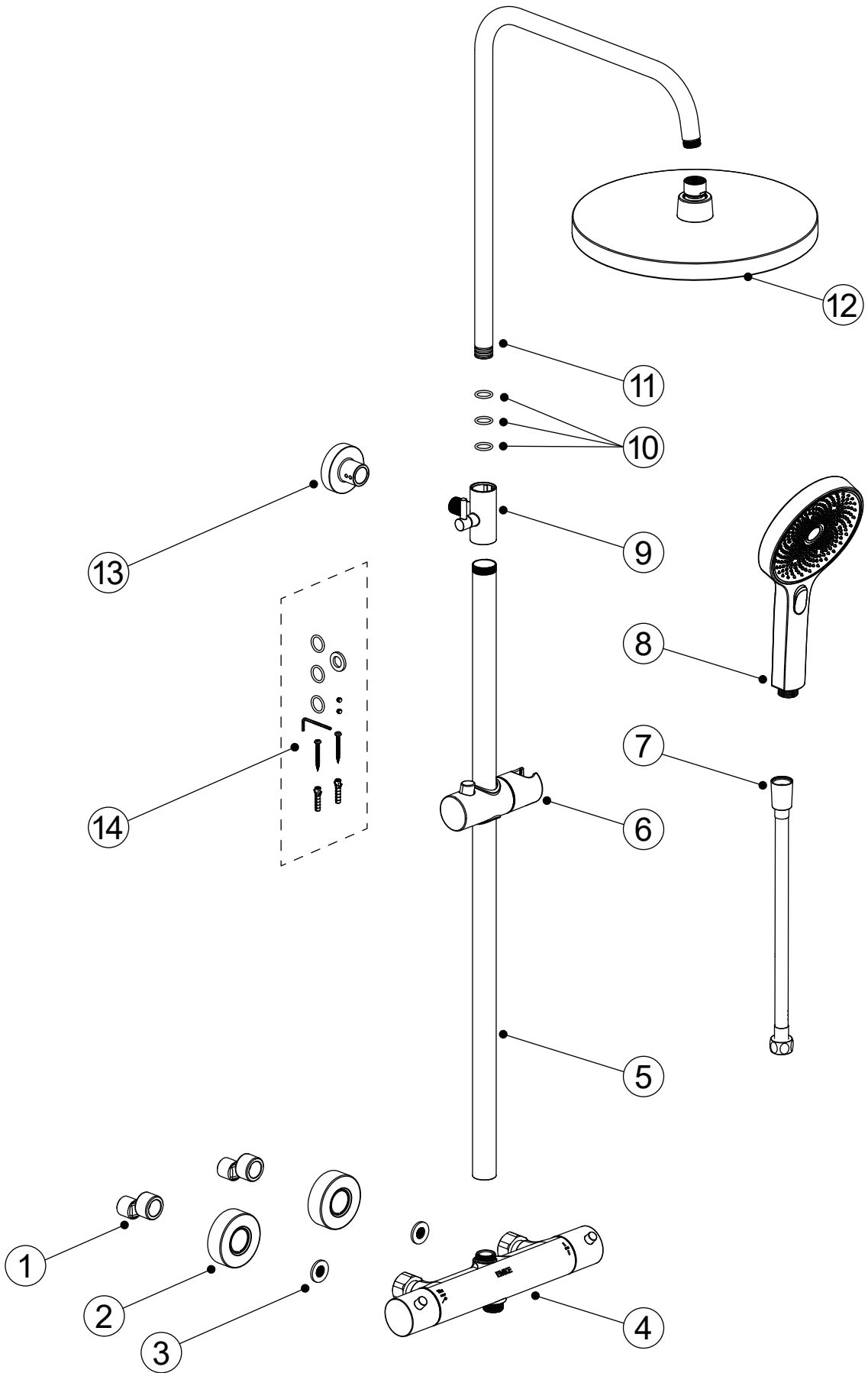

Step 1: Clean the water pipe and install the curved connector

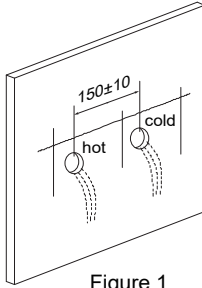

Figure 1

- a) Run the water around 1-2 minutes to clean the water pipe.
- b) Make sure the 2 curved connectors ① are installed dead straight into the wall. The centre distance between 2 curved connectors is 150 ± 10 mm and the centre line remains horizontal (Figure 1).

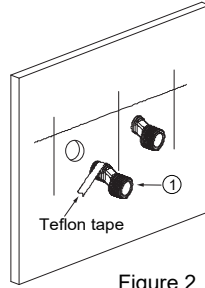

Figure 2

- c) Wrap the teflon tape anticlockwise on the thread of the G1/2 end, connect them to the hot and cold water outlets by a wrench. Leave suitable depth out of the wall and adjust the distance between 2 connectors according to the width of the inlet on the thermostatic shower bar (Figure 2).

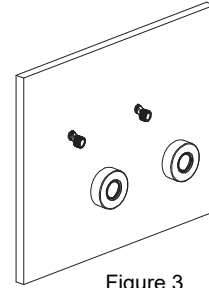

Figure 3

- d) Screw the decorative covers ② on the wall (Figure 3).

Step 2: Install the thermostatic shower bar

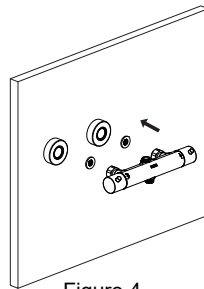

Figure 4

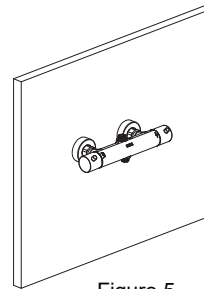

Figure 5

- a) Insert the filter rubber washer ③ inside the inlet of the thermostatic shower bar ④ (Figure 4). Connect the thermostatic shower bar onto the curved connectors (Figure 5). Left side is hot water and right side is cold water.

Step 3: Assemble the pipe for the shower head

- a) Insert the slider ⑥ over the riser rail ⑤ (Figure 6).
- b) Unlock the catch on the pipe connector ⑨ and connect the arm pipe ⑪ to the riser rail and tighten up (Figure 7).
- c) Connect the raiser rail to the thermostatic shower bar and mark the position of the pipe connector on the wall (Figure 8).

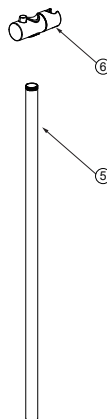

Figure 6

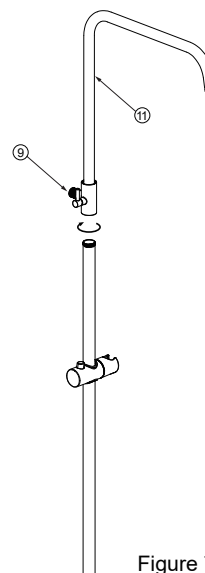

Figure 7

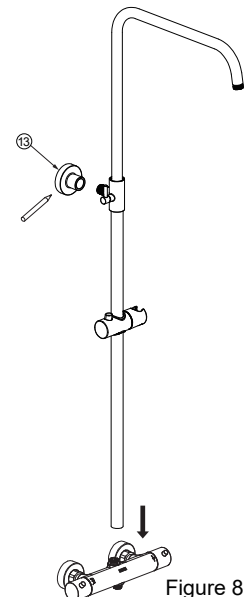

Figure 8

d) Install the wall holder ⑬ on the marked position (Figure 9). Cover the thermostatic shower bar to prevent the dust. Connect the pipe connector to the wall holder and use the Allen key to secure (Figure 10).

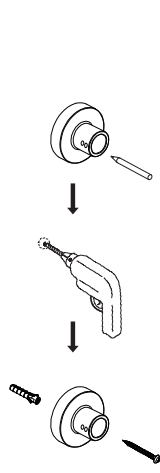

Figure 9

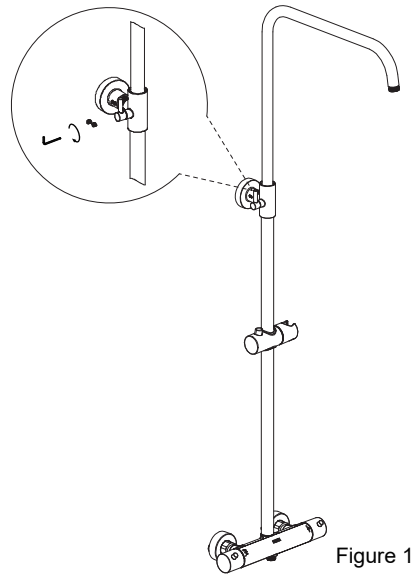
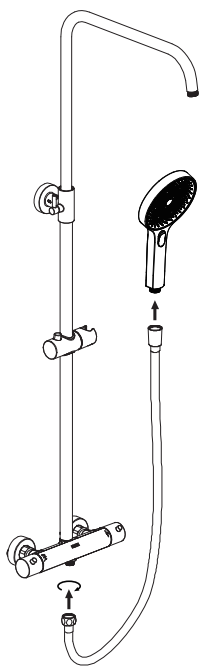
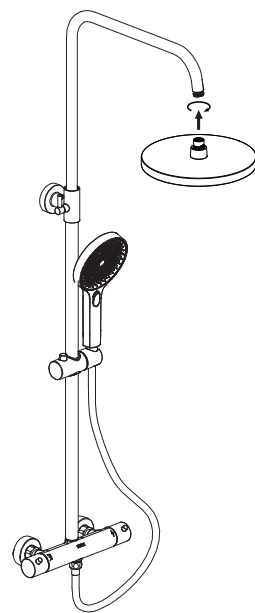

Figure 10

Step 4: Assemble the shower head (Make sure there is a washer inside of the shower head)



a) Connect the hose to the bottom of the thermostatic shower bar and connect the shower head on the other end.



b) Connect the overhead shower to the arm pipe.

Function Guide :

A. Adjust the water temperature:

Press and hold safety button, turn up and down to decrease and increase the temperature.

B. Switch between the hand shower and overhead shower:

turn the right hand control knob up and down.

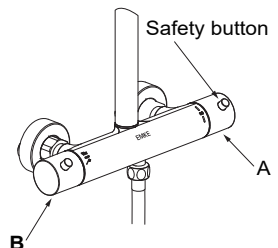

Schritt 1: Reinigen Sie die Wasserleitung und installieren Sie den gebogenen Anschluss



Abbildung 1

- a) Lassen Sie das Wasser etwa 1-2 Minuten laufen, um die Wasserleitung zu reinigen.
- b) Vergewissern Sie sich, dass die 2 gebogenen Verbindungsstücke ① genau gerade in die Wand eingebaut werden. Der Achsabstand zwischen 2 gebogenen Anschlüssen beträgt 150 ± 10 mm und die Mittellinie bleibt horizontal (Abbildung 1).

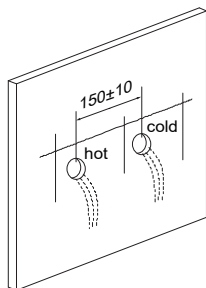

Abbildung 2

- c) Wickeln Sie das Teflonband gegen den Uhrzeigersinn um das Gewinde des G1/2-Endes und schließen Sie es mit einem Schraubenschlüssel an die Warm- und Kaltwasserauslässe an. Lassen Sie eine angemessene Tiefe aus der Wand heraus und stellen Sie den Abstand zwischen den beiden Anschlüssen entsprechend der Breite des Einlasses an der Thermostat-Duschstange ein (Abbildung 2).

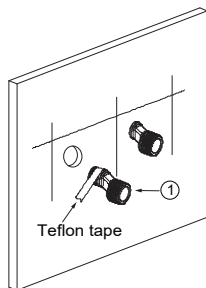

Abbildung 3

- d) Schrauben Sie die Zierabdeckungen ② an die Wand (Abbildung 3)

Schritt 2: Installation der Thermostat-Duschstange

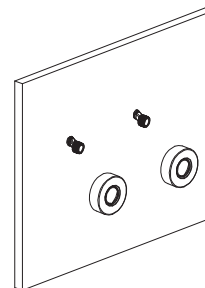

Abbildung 4



Abbildung 5

- a) Setzen Sie die Filtergummischeibe ③ in den Einlass der Thermostat-Duschstange ④ ein (Abbildung 4). Schließen Sie die thermostatische Duschstange an die gebogenen Anschlüsse an (Abbildung 5). Die linke Seite ist für Warmwasser und die rechte Seite für Kaltwasser.

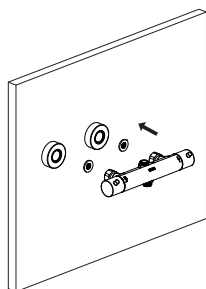
Schritt 3: Montieren Sie das Rohr für den Duschkopf

- a) Schieben Sie den Schieber ⑥ über die Steigschiene ⑤ (Abbildung 6).
- b) Entriegeln Sie die Verriegelung am Rohrverbinder ⑨ und verbinden Sie das Armrohr ⑪ mit der Steigschiene und ziehen Sie es fest (Abbildung 7).
- c) Steigrohr mit der Thermostatbrausestange verbinden und die Position des Rohrverbinders an der Wand markieren (Abbildung 8).

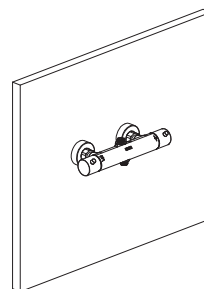

Abbildung 6



Abbildung 7

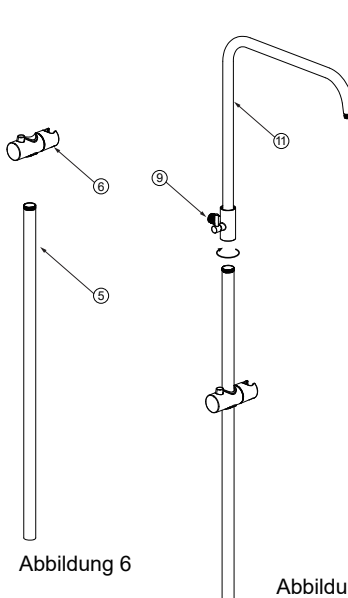

Abbildung 8

d) Montieren Sie die Wandhalterung 13 an der markierten Stelle (Abbildung 9). Decken Sie die Thermostatbrausestange ab, um Staub zu vermeiden. Verbinden Sie das Rohrverbindungsstück mit der Wandhalterung und sichern Sie es mit dem Inbusschlüssel (Abbildung 10).

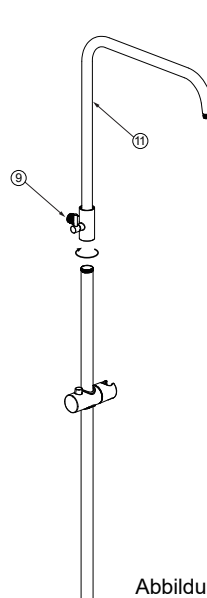

Abbildung 9

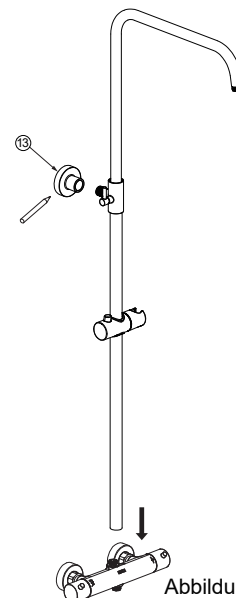

Abbildung 10

Schritt 4: Montieren Sie den Duschkopf (vergewissern Sie sich, dass sich eine Unterlegscheibe im Inneren des Duschkopfes befindet)

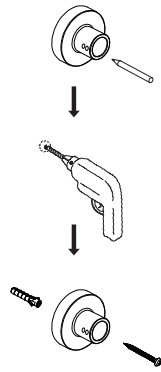

a) Verbinden Sie den Schlauch mit der Unterseite der Thermostat-Brausestange und schließen Sie den Duschkopf am anderen Ende an .

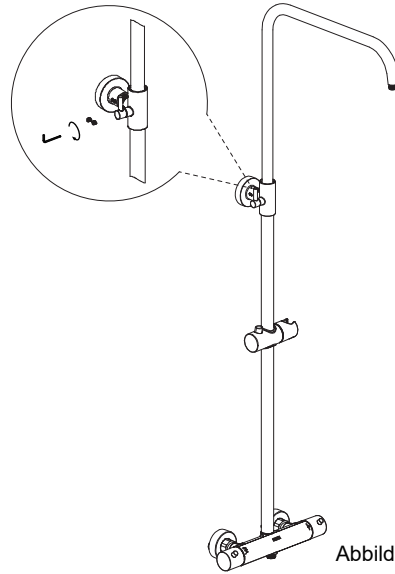
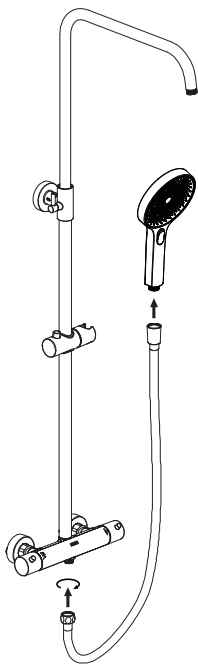
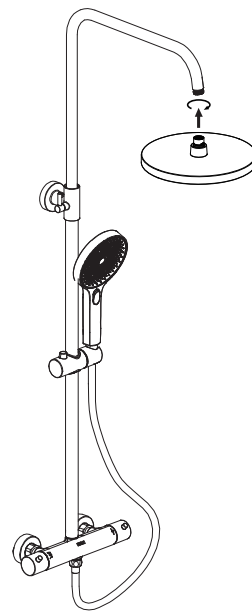

b) Schließen Sie die Kopfbrause an das Armrohr an.

Funktionsübersicht :

A. die Wassertemperatur einstellen:

Halten Sie den Sicherheitsknopf gedrückt und drehen Sie ihn nach oben und unten, um die Temperatur zu verringern oder zu erhöhen.

B. zwischen Hand- und Kopfbrause umschalten:

den rechten Bedienknopf nach oben und unten drehen.

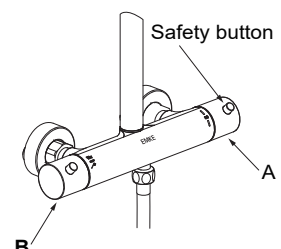

Étape 1 : Nettoyer le tuyau d'eau et installer le connecteur incurvé

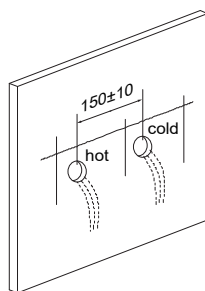

Figure 1

- a) Faites couler l'eau pendant 1-2 minutes pour nettoyer le tuyau d'eau.
- b) Assurez-vous que les 2 connecteurs courbes ① sont installés de manière mortelle et droite dans le mur. La distance centrale entre 2 connecteurs courbes est de 150 ± 10 mm et la ligne centrale reste horizontale (Figure 1).

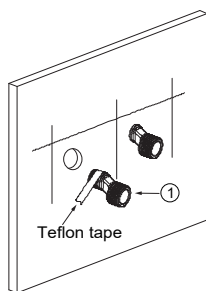

Figure 2

- c) Enroulez le ruban téflon dans le sens inverse des aiguilles d'une montre sur le filetage de l'extrémité G1/2, raccordez-les aux sorties d'eau chaude et froide à l'aide d'une clé. Laissez une profondeur suffisante dans le mur et ajustez la distance entre les 2 connecteurs en fonction de la largeur de l'entrée de la barre de douche thermostatique (Figure 2).

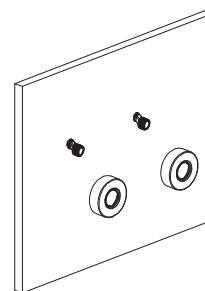

Figure 3

- d) Vissez les couvercles décoratifs ② sur le mur (Figure 3).

Étape 2 : Installer la barre de douche thermostatique

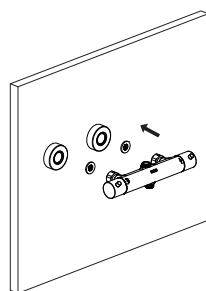

Figure 4

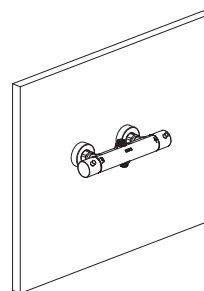

Figure 5

- a) Insérez la rondelle en caoutchouc filtrante ③ à l'intérieur de l'entrée de la barre de douche thermostatique ④ (Figure 4). Connectez la barre de douche thermostatique sur les connecteurs courbes (Figure 5). Le côté gauche est l'eau chaude et le côté droit l'eau froide.

Étape 3 : Assemblez le tuyau pour la pomme de douche.

- a) Insérez le curseur ⑥ sur le rail de la colonne montante ⑤ (Figure 6).
- b) Déverrouillez le loquet du raccord de tuyau ⑨ et raccordez le tuyau du bras ⑪ au rail de la colonne montante et serrez-le (Figure 7).
- c) Connecter le rail de la colonne montante à la barre de douche thermostatique et marquer la position du connecteur de tuyaux sur le mur (Figure 8).

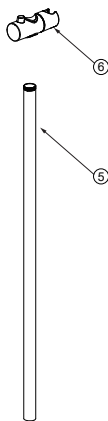

Figure 6

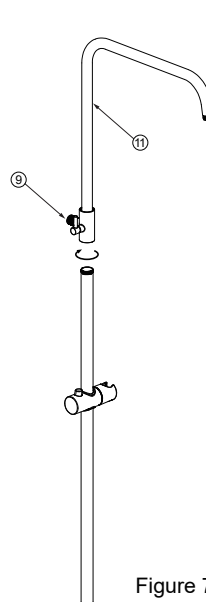

Figure 7

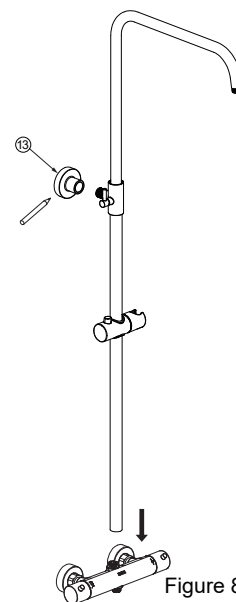

Figure 8

d) Installez le support mural 13 sur la position marquée (Figure 9). Couvrez la barre de douche thermostatique pour éviter la poussière. Raccordez le connecteur de tuyau au support mural et utilisez la clé Allen pour le fixer (Figure 10).

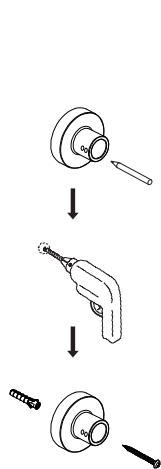

Figure 9

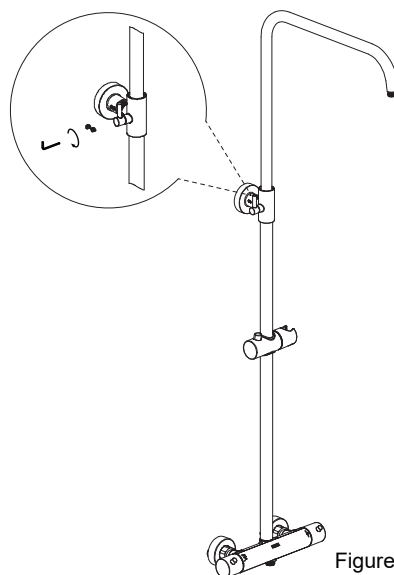
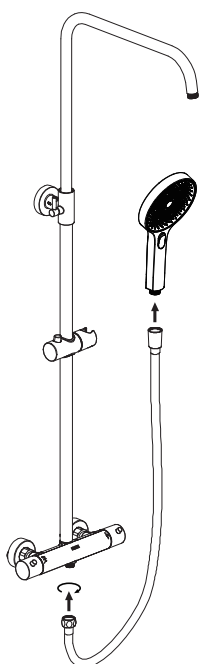
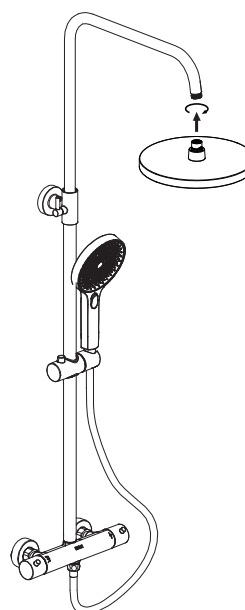

Figure 10

Étape 4 : Assembler la pomme de douche (Assurezvous qu'il y a une rondelle à l'intérieur de la pomme de douche)



a) Connectez le tuyau au bas de la barre de douche thermostatique et connectez la pomme de douche à l'autre extrémité.



b) Raccordez la douche de tête au tuyau du bras.

Guide des fonctions :

A. Régler la température de l'eau:

Appuyez et maintenez le bouton de sécurité, tournez vers le haut et le bas pour diminuer et augmenter la température.

B. passer de la douche à main à la douche de tête:

tourner le bouton de commande droit vers le haut et vers le bas.

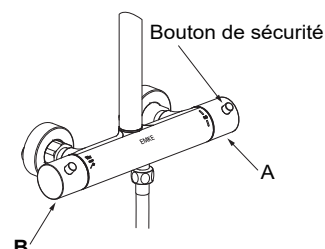

Paso 1: Limpiar la tubería de agua e instalar el conector curvo



Figura 1

- a) Deje correr el agua alrededor de 1-2 minutos para limpiar la tubería de agua.
- b) Asegúrese de que los 2 conectores curvos ① se instalan mortalmente rectos en la pared. La distancia central entre los 2 conectores curvos es de 150 ± 10 mm y la línea central permanece horizontal (Figura 1).

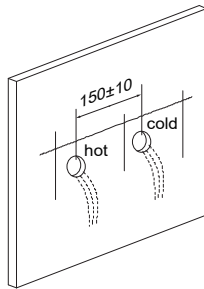

Figura 2

- c) Envuelva la cinta de teflón en sentido contrario a las agujas del reloj en la rosca del extremo G1/2, conéctelos a las salidas de agua caliente y fría con una llave. Deje una profundidad adecuada fuera de la pared y ajuste la distancia entre los 2 conectores según la anchura de la entrada en la barra de ducha termostática (Figura 2).

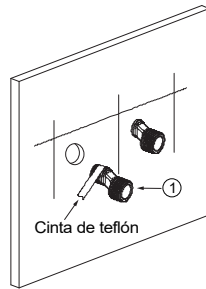

Figura 3

- d) Atornille las tapas decorativas ② en la pared (Figura 3).

Paso 2: Instalación de la barra de ducha termostática

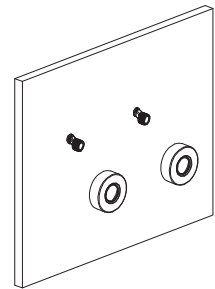

Figura 4



Figura 5

- b) Introduzca la arandela de goma del filtro ③ dentro de la entrada de la barra de ducha termostática ④ (Figura 4). Conecte la barra de ducha termostática en los conectores curvos (Figura 5). El lado izquierdo es de agua caliente y el derecho de agua fría.

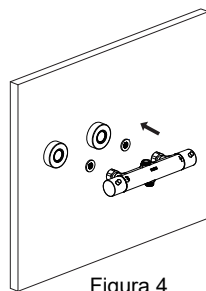
Paso 3: Montar el tubo para la alcachofa de la ducha

- a) Inserte el deslizador ⑥ sobre el riel ascendente ⑤ (Figura 6).
- b) Desbloquee el cierre del conector de la tubería ⑨ y conecte el tubo del brazo ⑪ al riel elevador y apriételo (Figura 7).
- c) Conecte el riel elevador a la barra de ducha termostática y marque la posición del conector de tubería en la pared (Figura 8).

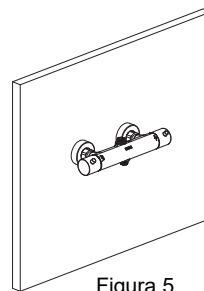
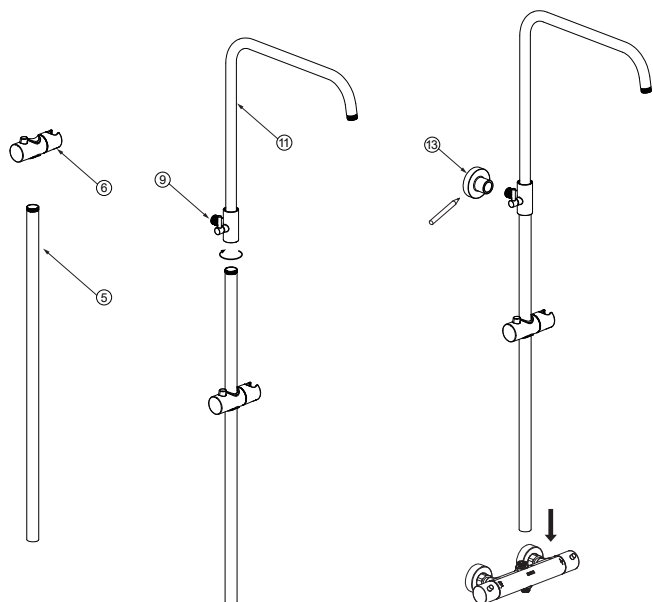

d) Instale el soporte de pared 13 en la posición marcada (Figura 9). Cubra la barra de ducha termostática para evitar el polvo. Conecte el conector de tuberías al soporte de pared y utilice la llave Allen para fijarlo (Figura 10).

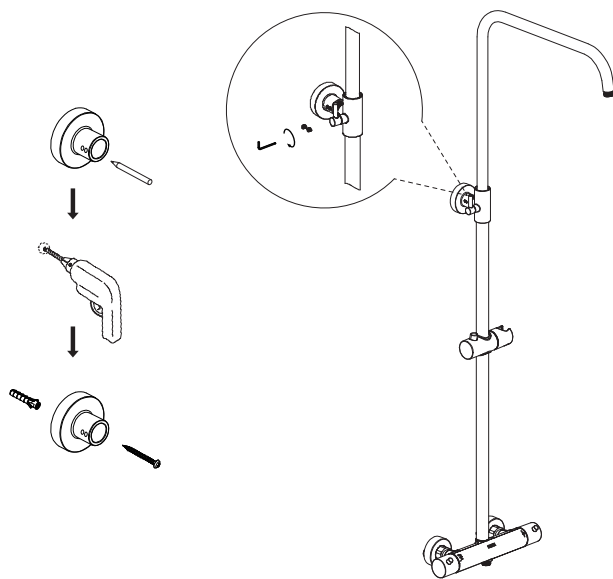

Paso 4: Montar la alcachofa de la ducha (Asegúrese de que hay una arandela dentro de la alcachofa de la ducha)

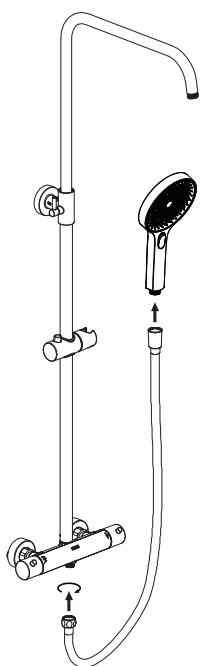

a) Conecte la manguera a la parte inferior de la barra de ducha termostática y conecte la alcachofa de la ducha en el otro extremo .

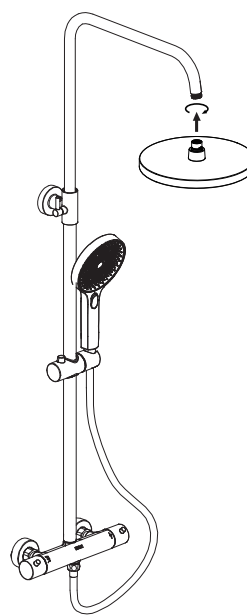

b) Conecte la alcachofa de la ducha al tubo del brazo.

Guía de funciones :

A. Ajuste la temperatura del agua:

Mantenga pulsado el botón de seguridad, gire hacia arriba y hacia abajo para disminuir y aumentar la temperatura.

B. Cambie entre la ducha de mano y la ducha de techo:

gire el mando de control derecho hacia arriba y hacia abajo.

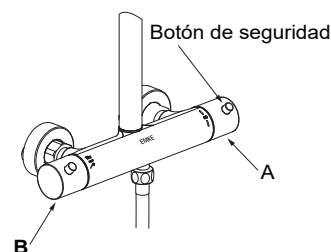

Fase 1: pulire il tubo dell'acqua e installare il connettore curvo



Figura 1

- a) Far scorrere l'acqua per 1-2 minuti per pulire il tubo dell'acqua.
- b) Assicurarsi che i 2 connettori curvi ① siano installati in modo mortalmente dritto nella parete. L'interasse tra i 2 connettori curvi è di 150 ± 10 mm e la linea centrale rimane orizzontale (Figura 1).

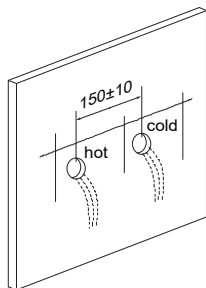

Figura 2

- c) Avvolgere il nastro di teflon in senso antiorario sulla filettatura dell'estremità G1/2, collegarli alle uscite dell'acqua calda e fredda con una chiave. Lasciare una profondità adeguata fuori dalla parete e regolare la distanza tra i due connettori in base alla larghezza dell'ingresso della barra termostatica della doccia (Figura 2)

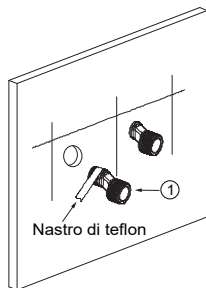

Figura 3

- d) Avvitare le coperture decorative ② alla parete (Figura 3).

Fase 2: Installazione della barra termostatica della doccia

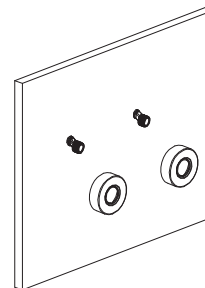

Figura 4



Figura 5

- a) Inserire la rondella di gomma del filtro ③ all'interno dell'ingresso della barra termostatica della doccia ④ (Figura 4). Collegare la barra termostatica della doccia ai connettori curvi (Figura 5). Il lato sinistro è quello dell'acqua calda e il lato destro quello dell'acqua fredda.

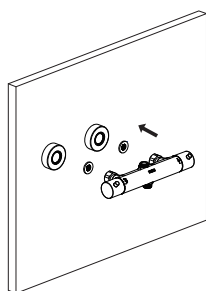
Fase 3: montaggio del tubo per il soffione doccia

- a) Inserire il cursore ⑥ sulla barra montante ⑤ (Figura 6).
- b) Sbloccare il fermo sul connettore del tubo ⑨ e collegare il tubo del braccio ⑪ alla barra montante e serrare (Figura 7).
- c) Collegare la barra montante alla barra termostatica della doccia e segnare la posizione del connettore del tubo sulla parete (Figura 8).

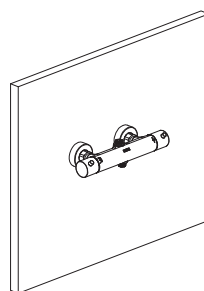

Figura 6



Figura 7

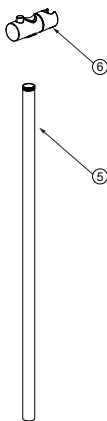

Figura 8

d) Installare il supporto a parete 13 sulla posizione segnata (Figura 9). Coprire la barra termostatica della doccia per evitare la polvere. Collegare il connettore del tubo al supporto a parete e utilizzare la chiave a brugola per fissarlo (Figura 10).

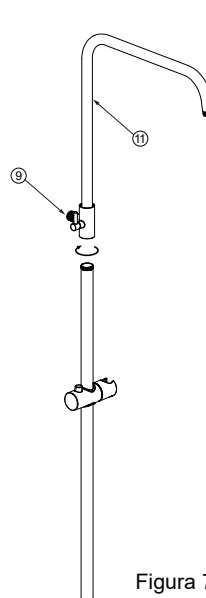

Fase 4: Assemblare il soffione (accertarsi della presenza di una rondella all'interno del soffione)

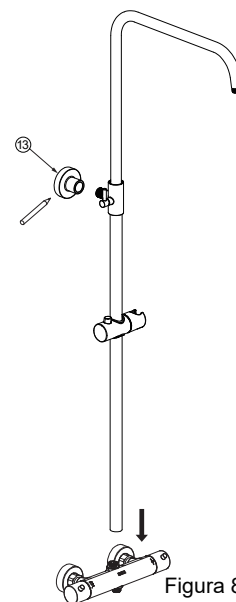
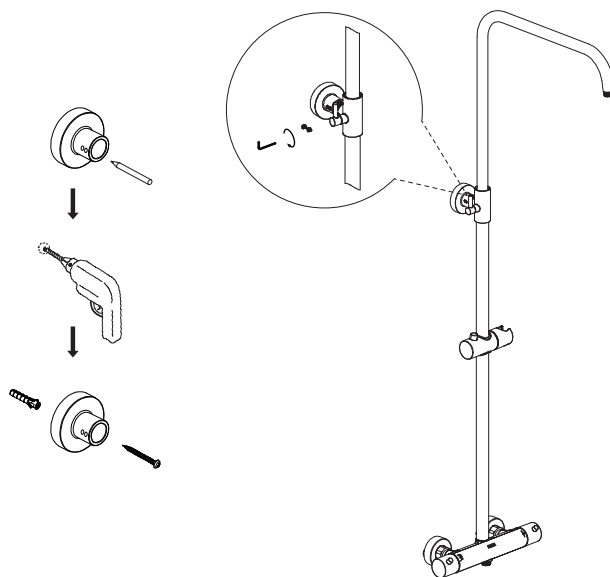
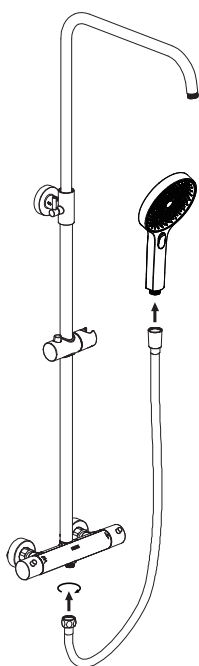

a) Collegare il tubo flessibile alla parte inferiore della barra termostatica della doccia e collegare il soffione all'altra estremità.

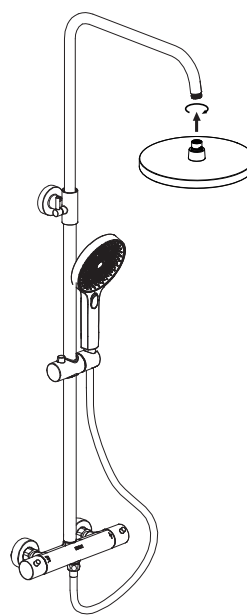

b) Collegare il soffione al tubo del braccio.

Guida alle funzioni :

A. Regolare la temperatura dell'acqua:

Tenere premuto il pulsante di sicurezza, ruotare verso l'alto e verso il basso per diminuire e aumentare la temperatura.

B. Passare dalla doccetta al soffione:

ruotare la manopola di controllo destra verso l'alto e verso il basso.

