

ASSEMBLY INSTRUCTION

WF320161

WF320162

TIPS

1. Please read the instructions fully before assembly. These instructions include important information which could ensure correct assembly. We have been working on providing high quality products for you. However, in the rare instance that your product is defective, missing parts or there are some issues, please don't hesitate to contact our customer service to submit parts requirements, assembly suggestion, or warranty claims, and we will give the best solution as soon as possible. If necessary, we need you to provide some more clear pictures of the issue.
2. Insert the screws in holes and tighten the screws, but not too tight, 70%~80% is ok, finally tighten all the screws. If some issues happened that some screws can not target to the hole or some parts are difficult to install, please adjust the tightness of the screws.
3. 2 people are recommended to finish



Rappel

1. Veuillez lire les instructions soigneusement avant d'assembler. Ces instructions contiennent des informations importantes qui peuvent assurer un montage correct. Nous nous efforçons toujours de vous fournir des produits de haute qualité. Cependant, dans les rares cas où votre produit est défectueux, des pièces manquantes ou si vous avez des questions, n'hésitez pas à contacter notre service à la clientèle pour soumettre une demande de pièces, une proposition d'assemblage ou une réclamation de garantie. Nous vous donnerons la meilleure solution dès que possible. Si nécessaire, nous avons besoin de quelques images plus claires de votre problème.
2. Insérez la vis dans le trou et serrez la vis, mais pas trop. 70%~80% est ok. Enfin, serrez toutes les vis. Si quelques problèmes se produisent, certaines vis ne peuvent pas être alignées sur le trou ou certaines pièces sont difficiles à installer, ajustez SVP l'étanchéité des vis
3. Recommandé pour 2 personnes

Tipp.

1. Bitte lesen sie die anleitung vor der montage sorgfältig durch Die anleitungen enthalten wichtige informationen, die eine richtige montage ermöglichen. Wir haben versucht, ihnen ein qualitativ hochwertiges produkt anzubieten. Aber in seltenen fällen, in denen ihr produkt mangelhaft ist, fehlt vielleicht noch ein teil Oder es stimmt etwas nicht, zögern sie nicht, sich an unsere kundendienst zu wenden, um bauteilanforderungen, bauvorschläge Oder garantieforderungen einzureichen, dann haben wir bald die beste lösung. Wenn nötig, haben wir ein paar genauere fotos Von den problemen.
2. Schrauben einführen und schrauben, aber nicht zu eng - 70 bis 80 prozent gehen, um alle schrauben schließlich zu befestigen. Bei problemen, die das bohren Von löchern erschweren Oder schwierigkeiten bereiten, sollten sie die schrauben lockern
3. Empfohlen zwei personen für fertigstellung

Es gibt : **1L**, **1R**, **2**, **12**, **13**, **23**, **24**, **26**.
in Kopfbrett

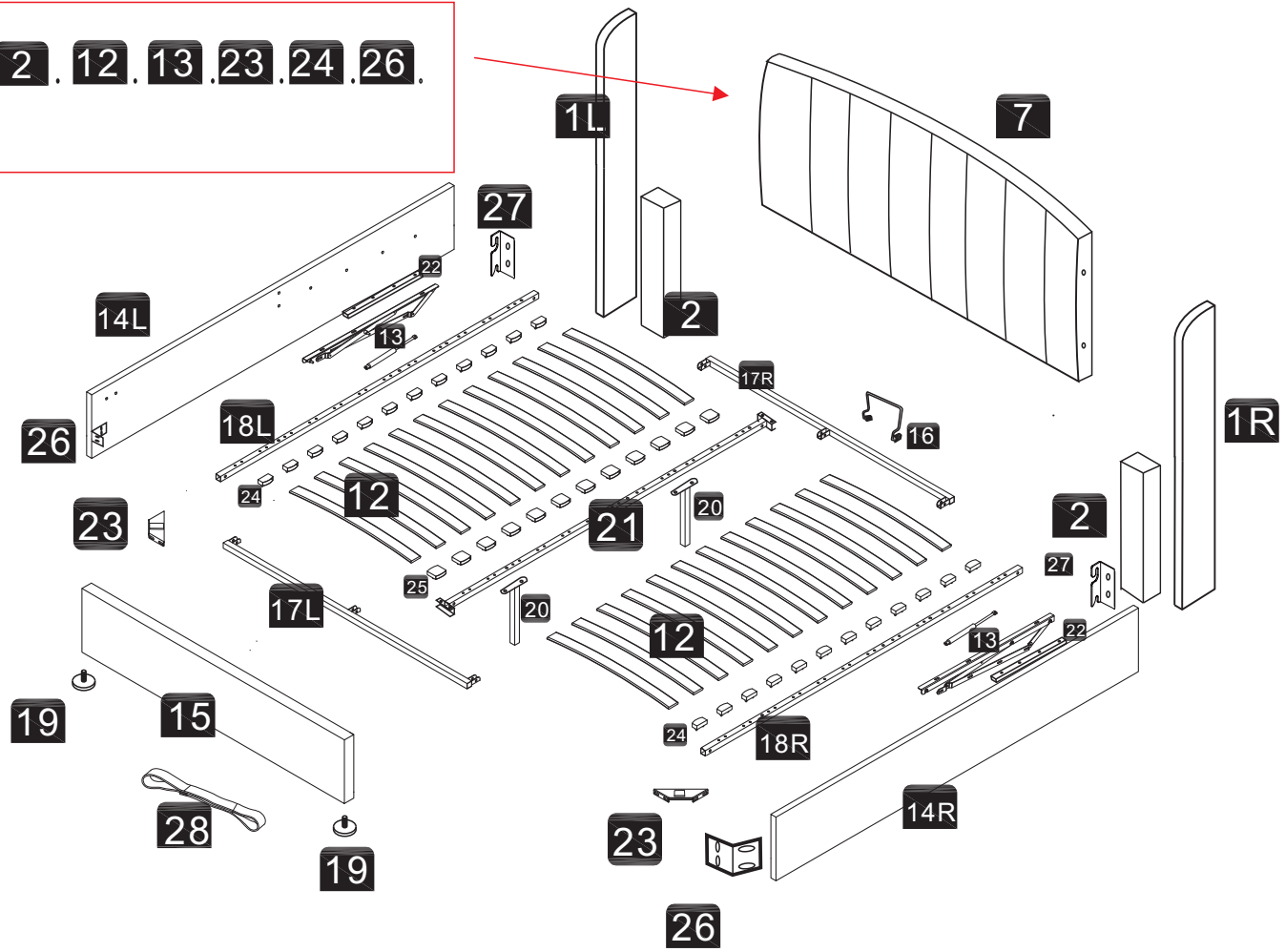



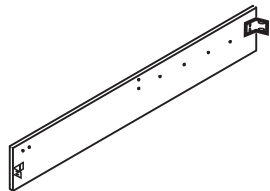
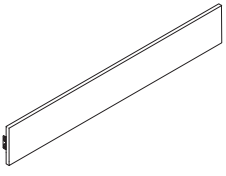
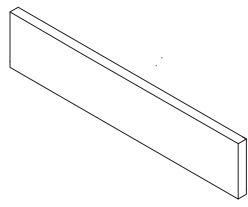
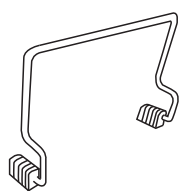
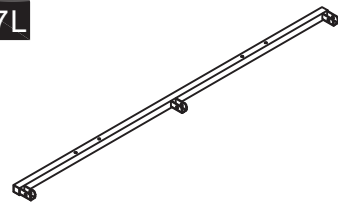
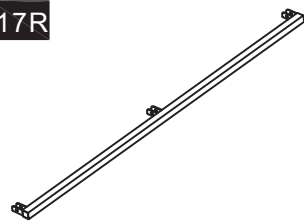
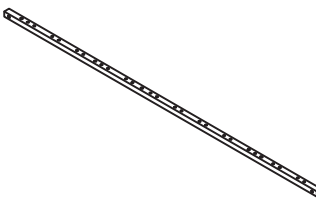
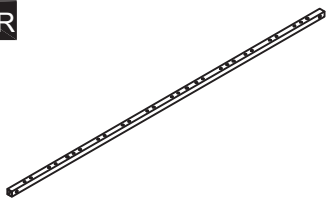
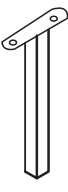
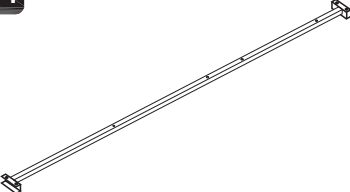
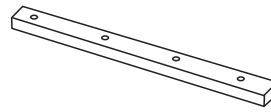
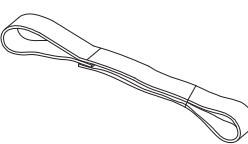

Part List WF320161

1L x1	1R x1	2 x2	7 x1
12 x24	13 x2	19 x4	23 x2
24 x24	25 x12	26 x2	27 x2

Part List WF320162

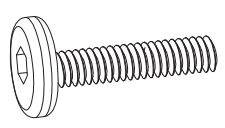
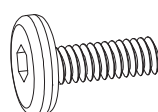
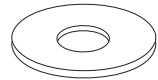
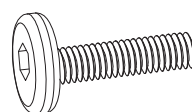
<p>14L</p>  <p>x1</p>	<p>14R</p>  <p>x1</p>	<p>15</p>  <p>x1</p>	<p>16</p>  <p>x1</p>
<p>17L</p>  <p>x1</p>	<p>17R</p>  <p>x1</p>	<p>18L</p>  <p>x1</p>	<p>18R</p>  <p>x1</p>
<p>20</p>  <p>x2</p>	<p>21</p>  <p>x1</p>	<p>22</p>  <p>x2</p>	<p>28</p>  <p>x1</p>

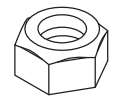
Hardware List WF320162

<p>A</p>  <p>(M8x45mm) × 20</p>	<p>B</p>  <p>(M8x20mm) × 24</p>	<p>C</p>  <p>× 56</p>	<p>D</p>  <p>(M8x40mm) × 12</p>
<p>E</p>  <p>× 1</p>	<p>F</p>  <p>(M8) × 18</p>	<p>G</p>  <p>× 1</p>	

IMPORTANT NOTICE

OTTOMAN OPERATING INSTRUCTIONS

Once your bed frame is completely assembled, the slat unit will not operate correctly unless a mattress is placed on the slat frame. Position the mattress on the slat frame whilst it is in the closed position.

PLEASE NOTE - It takes a lot of force to make the initial movement of the ottoman. This is a design feature of the product so that it does not fall shut - the nearer to being closed the ottoman is, the easier it is to move. When the ottoman is almost shut, it will close completely under its own weight.

When lowering the slat unit for the first time, take care to make sure it does not rub unevenly on the inside face of the side rails. If it does, the bed has been assembled slightly out of square. This can be rectified by moving the foot end of the bed slightly to the left or right whilst leaving the head end stationary.

PISTONS

The pistons used in the construction of this product are extremely strong and cannot be operated by hand when taken off the ottoman. All pistons are tested for correct pressure and operation before being attached to the slat unit.

Initially it might appear that the pistons are very stiff when opening and closing the ottoman.

THIS IS PERFECTLY NORMAL

When fully assembled and the mattress is in position, please raise and lower the ottoman 4/5 times to ensure the gas piston are fully lubricated.

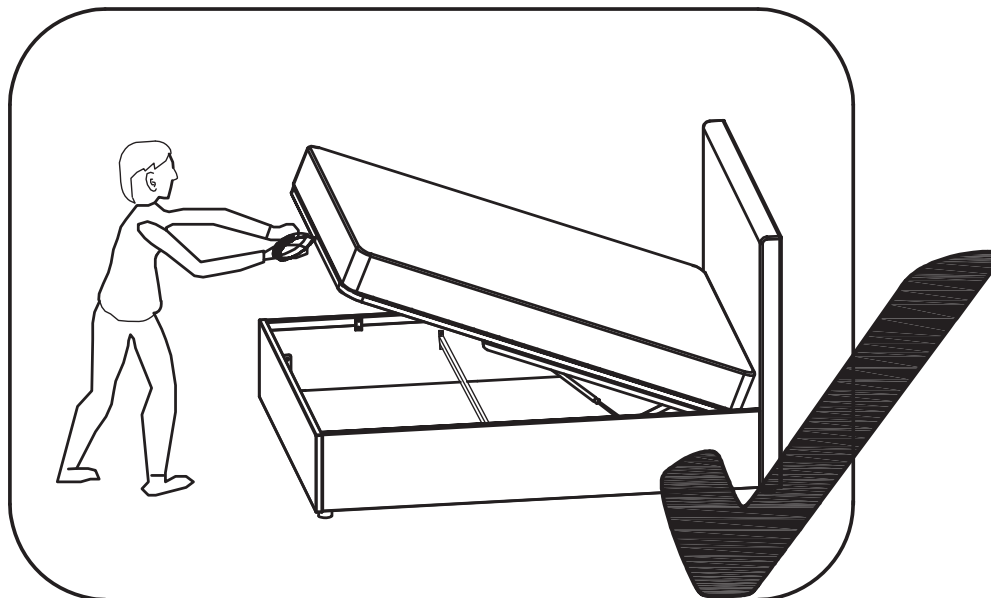
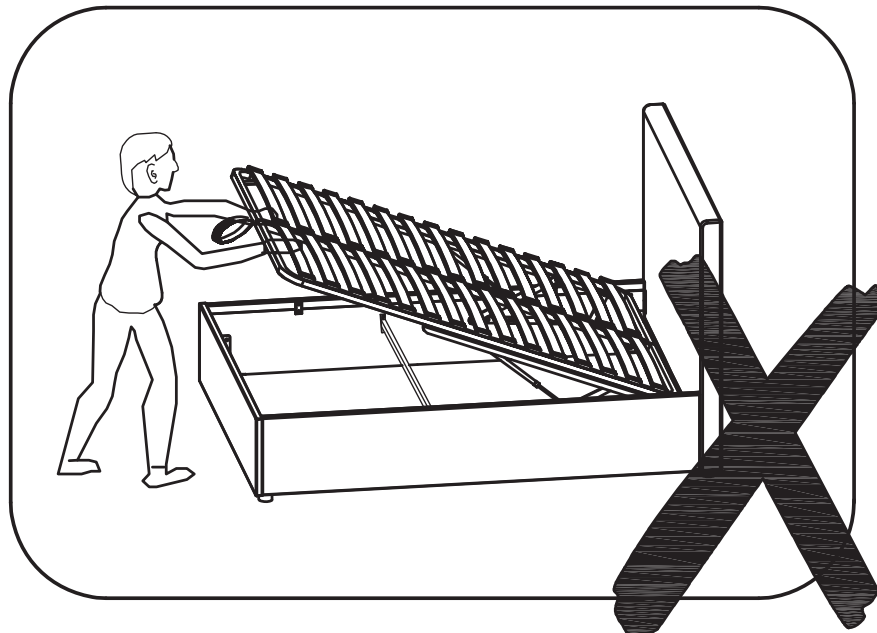

AVIS IMPORTANT
INSTRUCATIONS DE FONCTIONNEMENT OTTOMAN

Une fois que votre cadre de lit est complètement assemblé, l'unité de latte ne fonctionnera pas de manière correcte à moins qu'un matelas ne soit placé sur le cadre de la latte. Positionnez Theattress sur le cadre de la latte pendant qu'il est en position fermée.

VEUILLEZ NOTER-Il faut beaucoup de force pour faire le mouvement initial du pouf. Il s'agit d'une caractéristique de conception du produit afin qu'elle ne se ferme pas - la plus proche d'être fermée, plus il est facile de se déplacer. Lorsque le pouf est le plus fermé, il se

Lorsque vous abaissez l'unité de latte pour la première fois, veuillez à vous assurer qu'elle ne frotte pas de manière inégale sur la face intérieure des rails latéraux. F c'est le cas, le lit a été assemblé légèrement hors carré. Cela peut être rectifié en déplaçant légèrement l'extrémité du pied du lit vers la

PISTONS

The pistons used in the construction of this product are extremely strong and cannot be operated by hand when taken off the ottoman. All pistons are tested for correct pressure and operation before being attached to the slat unit.

Initialement, il pourrait sembler que les pistons sont très raides lors de l'ouverture et de la fermeture de l'otoman.

C'EST PARFAITEMENT NORMAL

Une fois entièrement assemblé et que le matelas est en position, veuillez élever et abaisser les 4/5 fois ottoman pour vous assurer que le pistonare à gaz est entièrement lubrifié.

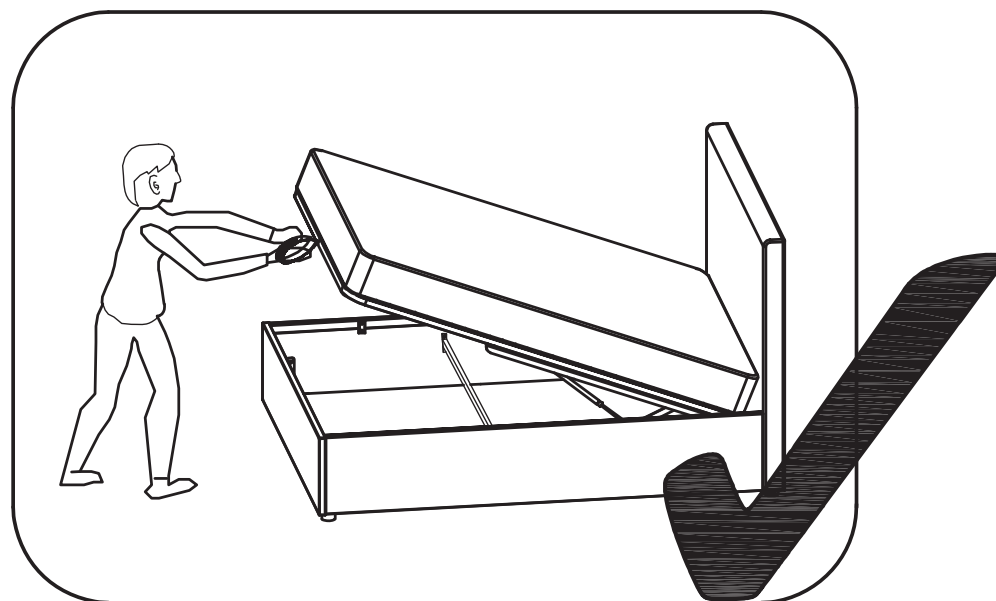
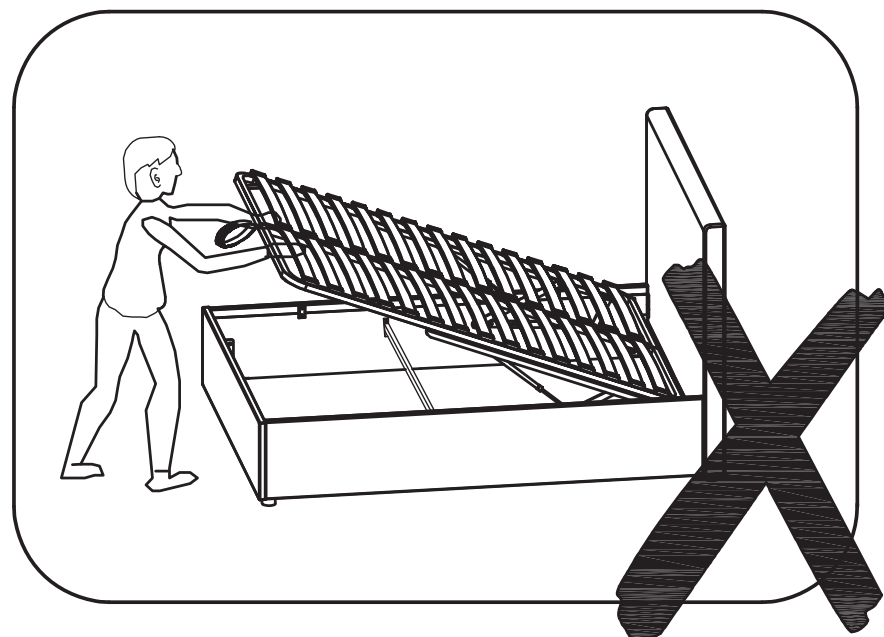

WICHTIGE BEKANNTMACHUNG
OSMANISCHE BETRIBSANWEISUNGEN

Sobald Ihr Bettrahmen vollständig zusammengebaut ist, wird die Lamelle nicht korrekt betrieben, es sei denn, eine Matratze wird auf dem Lamellenrahmen platziert. Positionieren Sie die Themenattress auf dem Lamellenrahmen, während sie sich in der geschlossenen Position befindet.

BITTE BEACHTEN SIE-Es braucht viel Kraft, um die anfängliche Bewegung des Osmanischen Osmanischen zu machen. Dies ist ein Designmerkmal des Produkts, damit es nicht geschlossen wird-desto einfacher ist es, sich zu bewegen. Wenn die Osmanische am meisten geschlossen ist, wird er unter seinem eigenen Gewicht vollständig geschlossen.

Achten Sie beim ersten Absenken der Lamelleneinheit, um sicherzustellen, dass sie auf der Innenseite der Seitenschienen nicht ungleichmäßig astet. F es ist das Bedhas leicht aus dem Quadrat versammelt. Dies kann korrigiert werden, indem das Fußende des Bettes leicht nach links oder rechts bewegt

KOLBEN



Die beim Bau dieses Produkts verwendeten Kolben sind extrem stark und können nicht von Hand betrieben werden, wenn sie aus dem Osmanisch genommen werden. Alle Pistonsare wurden auf korrekten Druck und Betrieb getestet, bevor sie an der Lamelleneinheit angebracht werden. Anfänglich mag es so aussehen, als ob die Kolben beim Öffnen und Schließen der Osmanischen sehr steif sind.

Das ist völlig normal

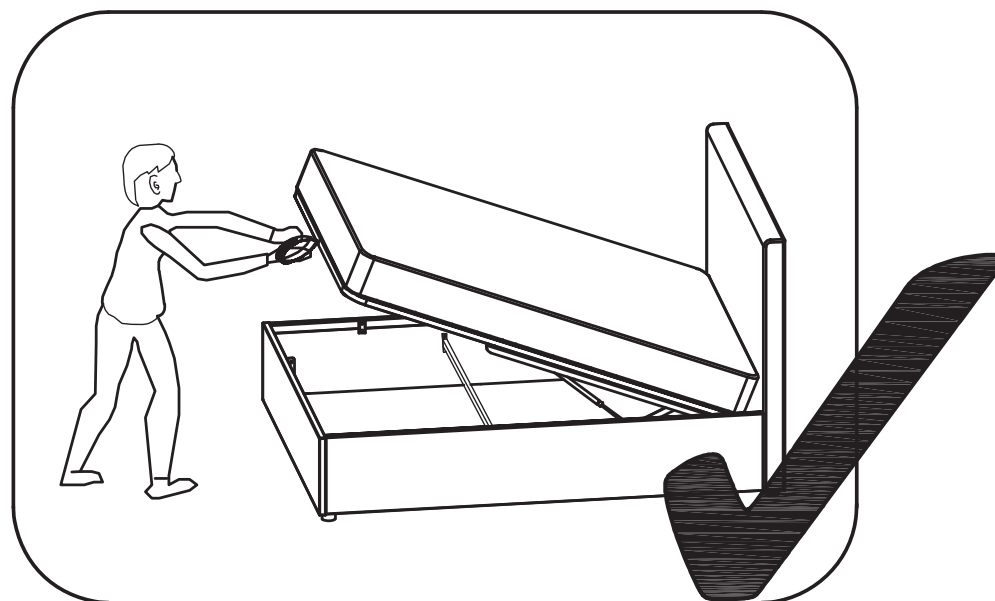
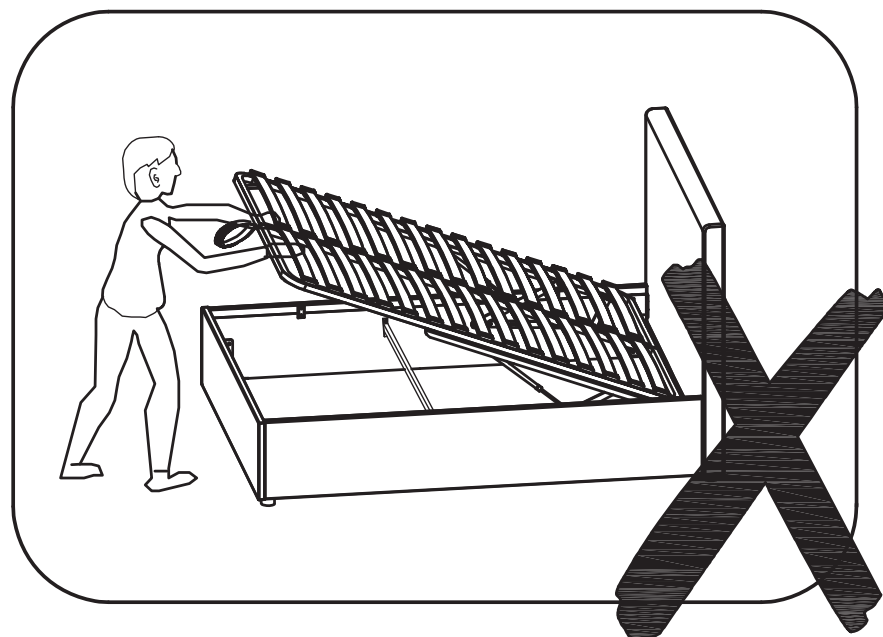
Wenn sich die Matratze vollständig versammelt und die Matratze in Position ist, erhöhen Sie bitte das 4/5 -fache Ottomane, um sicherzustellen, dass der Gaskolbenporte vollständig geschmiert ist.



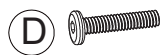

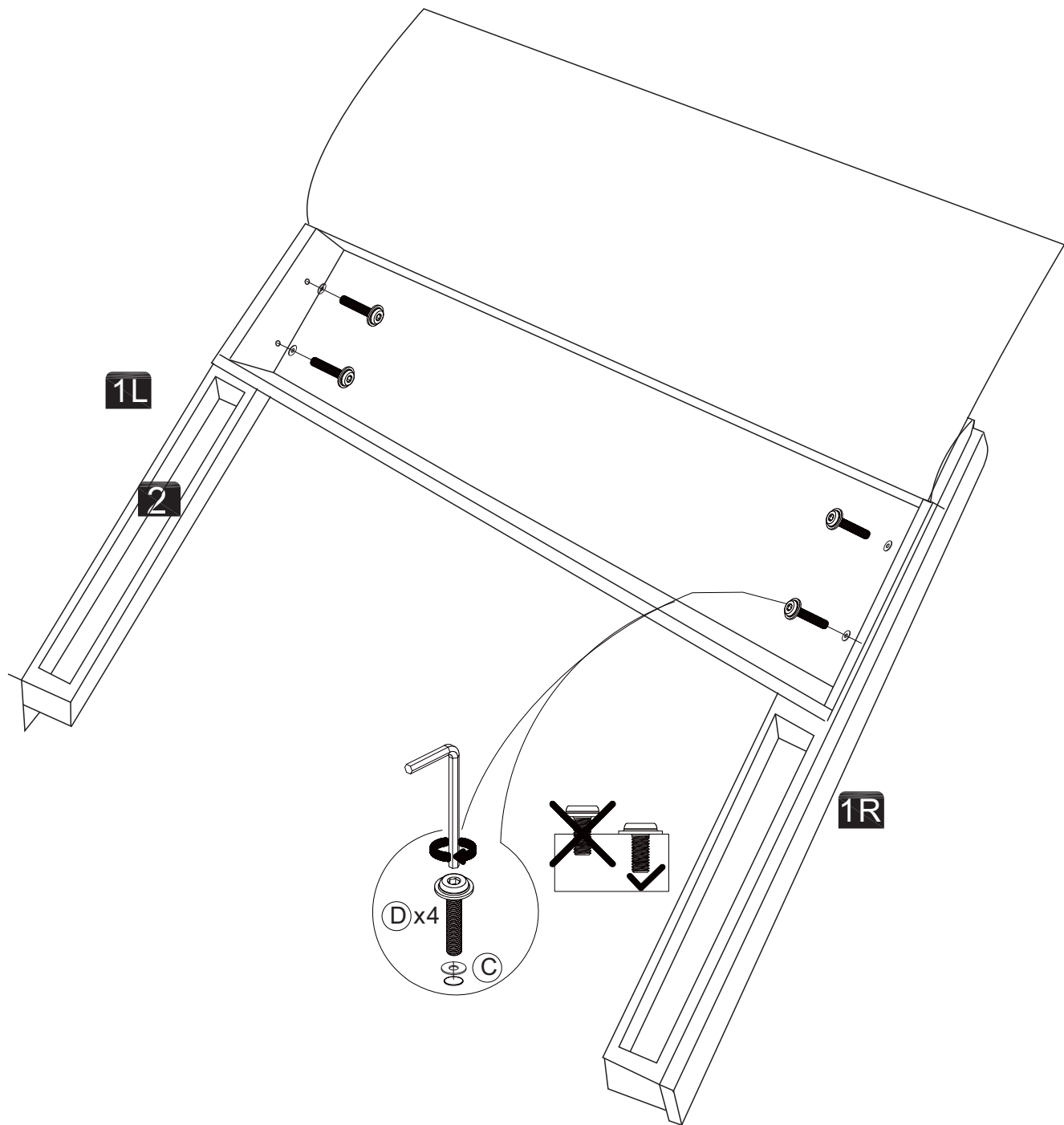
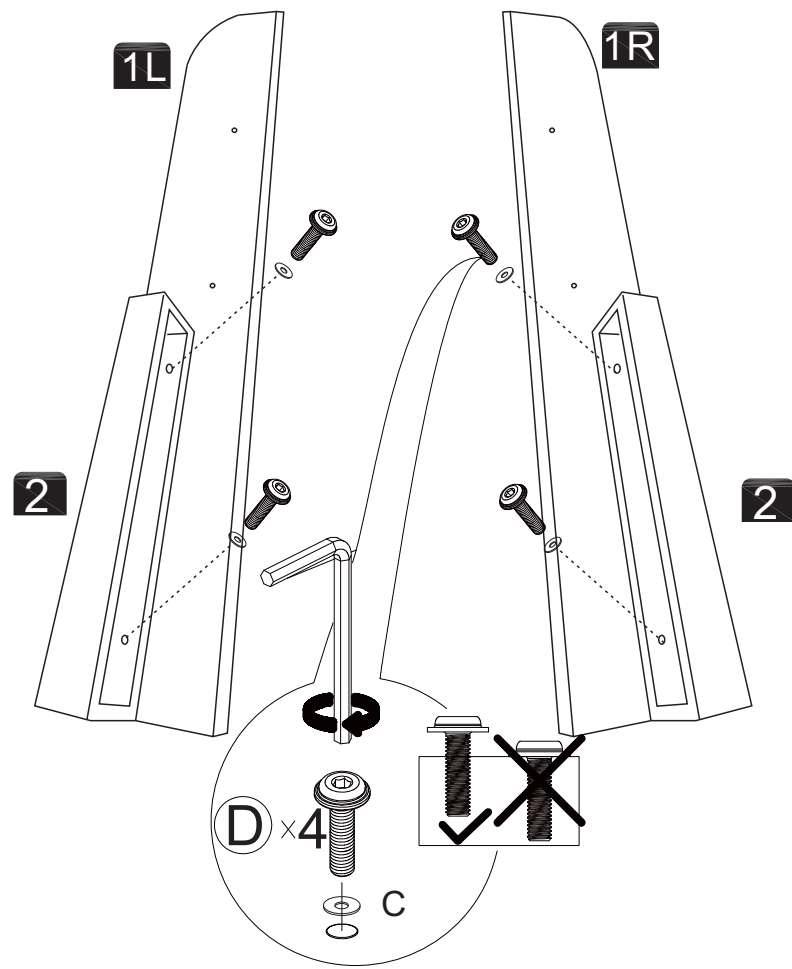

Step 1 :

-  **D** x8
-  **C** x8
-  **G** x1



Step2:

- (A)**  x6
- (B)**  x8
- (C)**  x14
- (G)**  x1

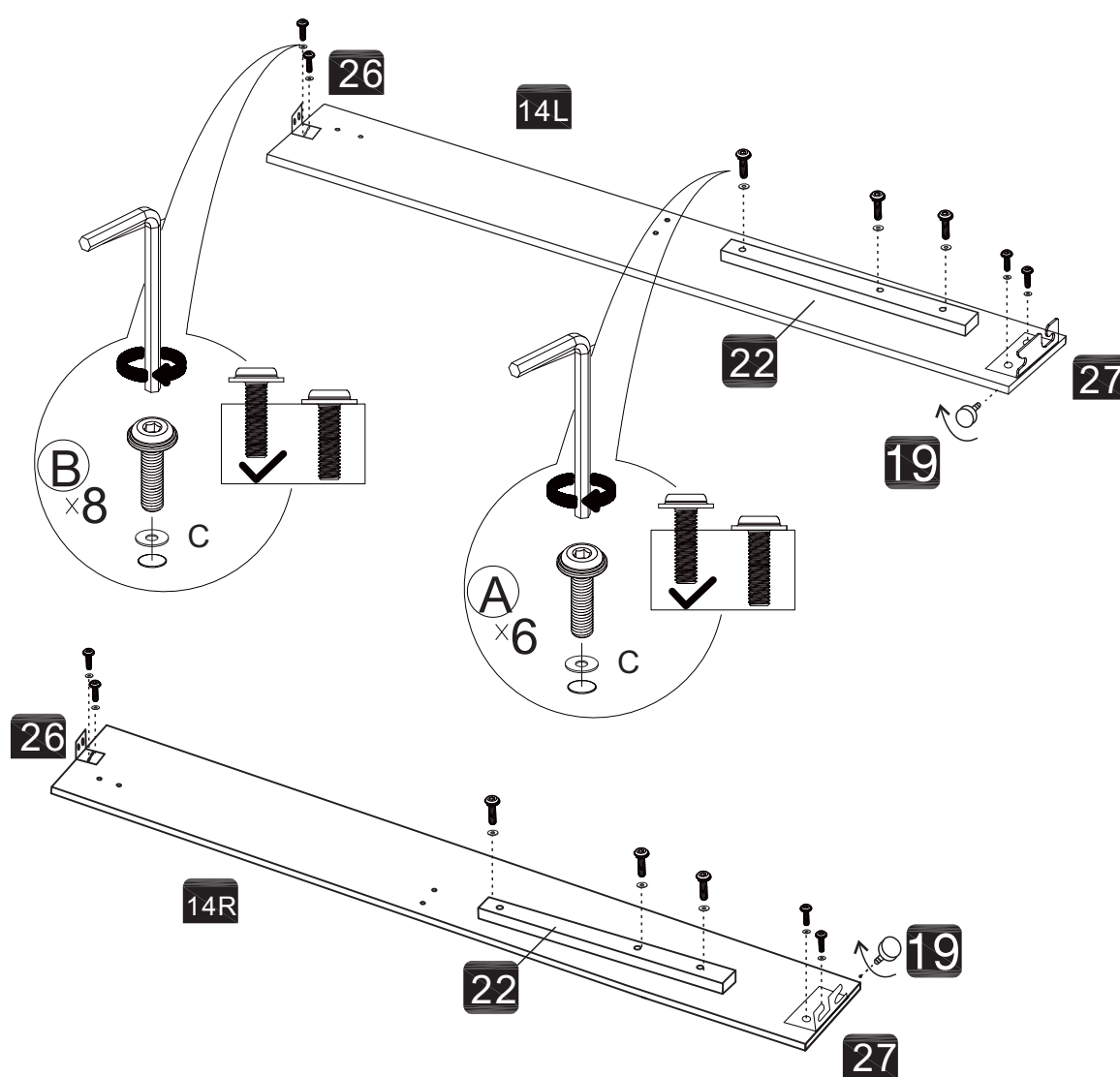

Step3:

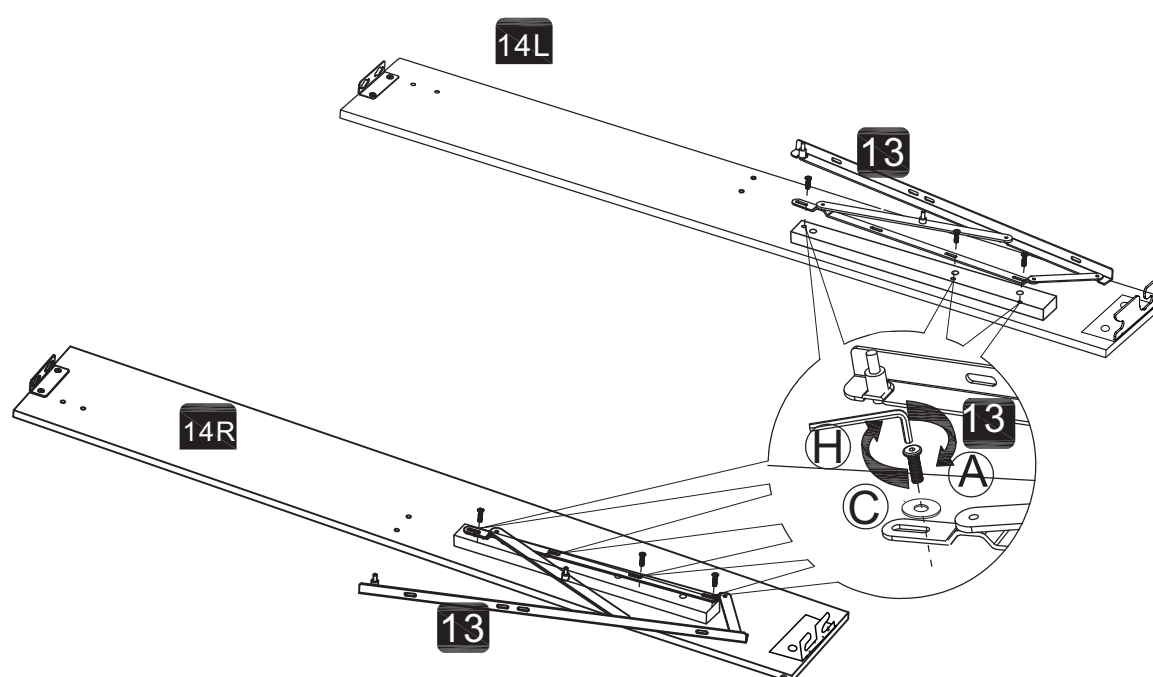



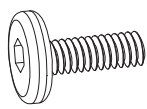
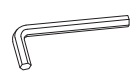
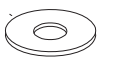

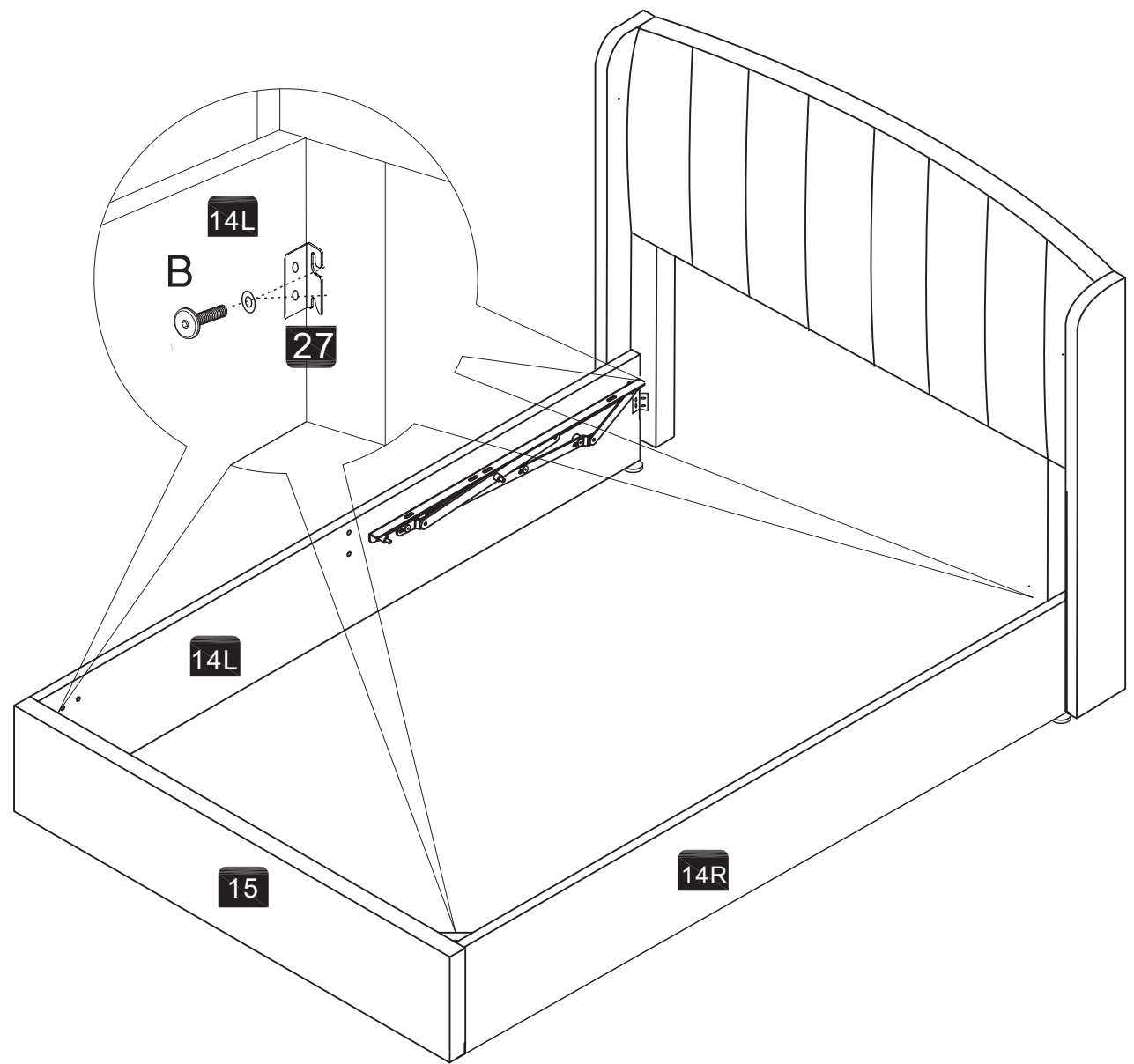
Step4:

- B**  x8
- G**  x1
- C**  x8

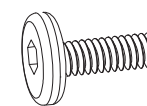



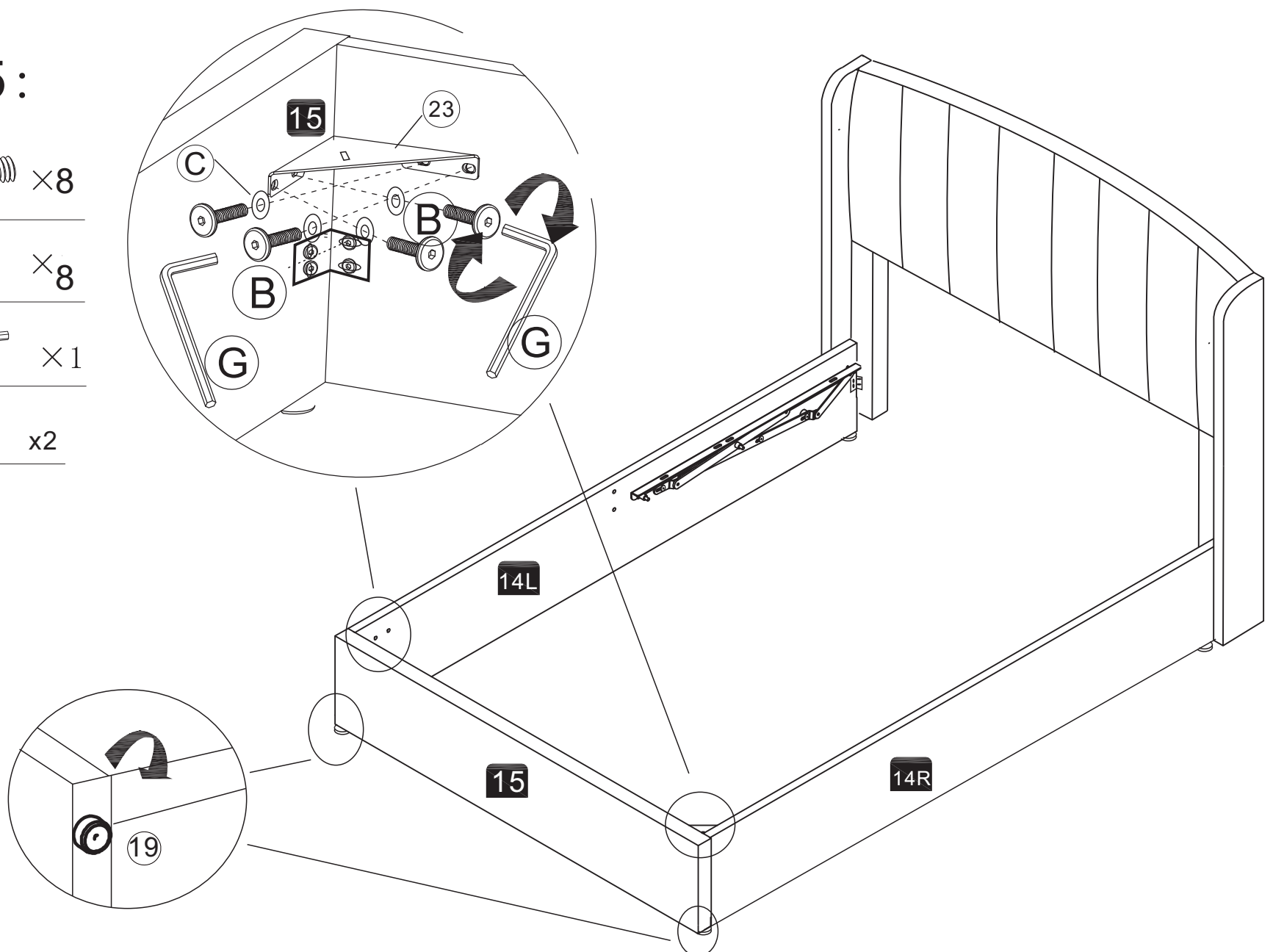

Step5:

- B**  x8
- C**  x8
- G**  x1
- 19**  x2







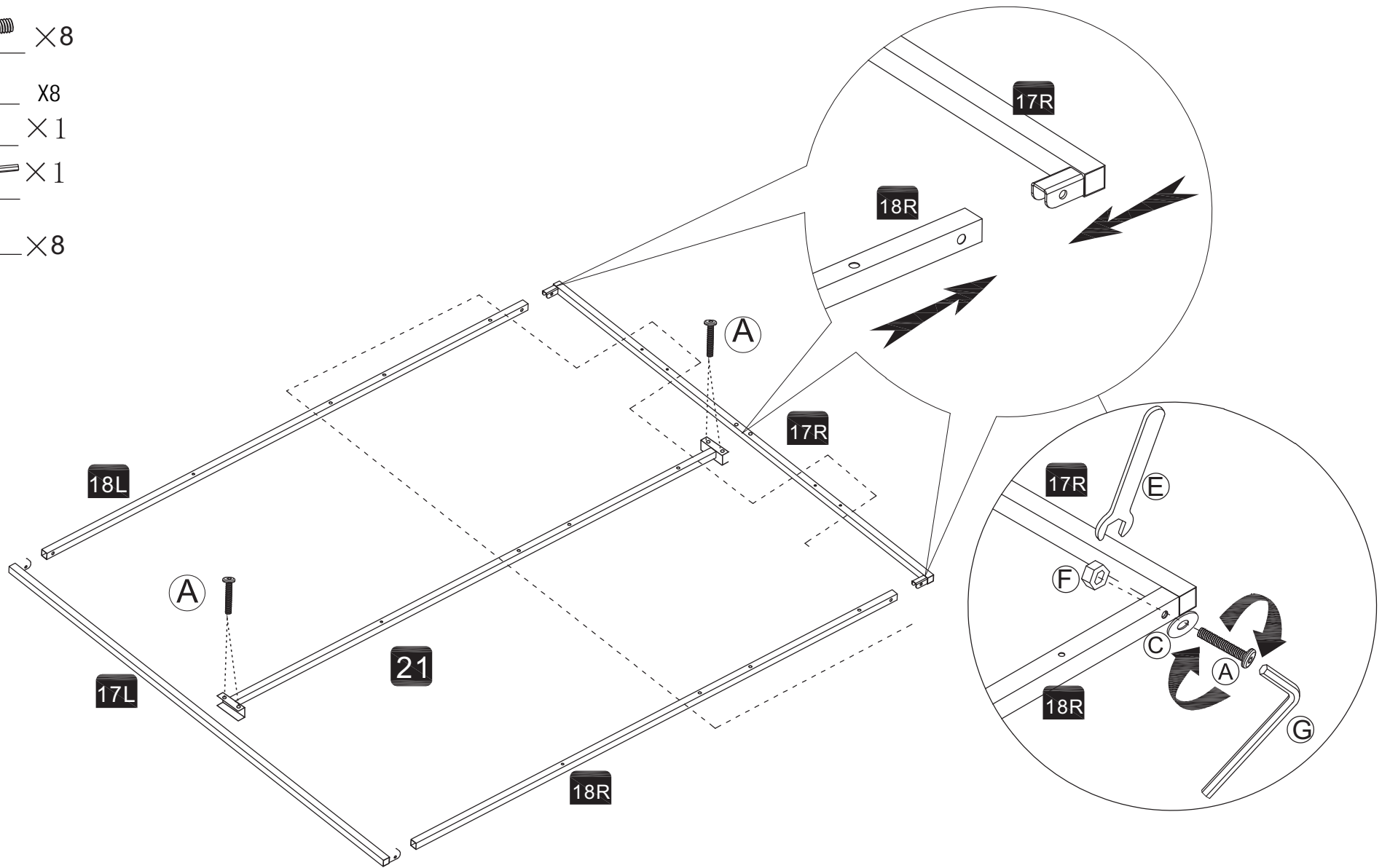

Step6:

- (A)  ×8
- (F)  ×8
- (E)  ×1
- (G)  ×1
- (C)  ×8



Step7:

- (A)  ×6
- (D)  ×4
- (F)  ×6
- (E)  ×1
- (G)  ×1
- (C)  ×10

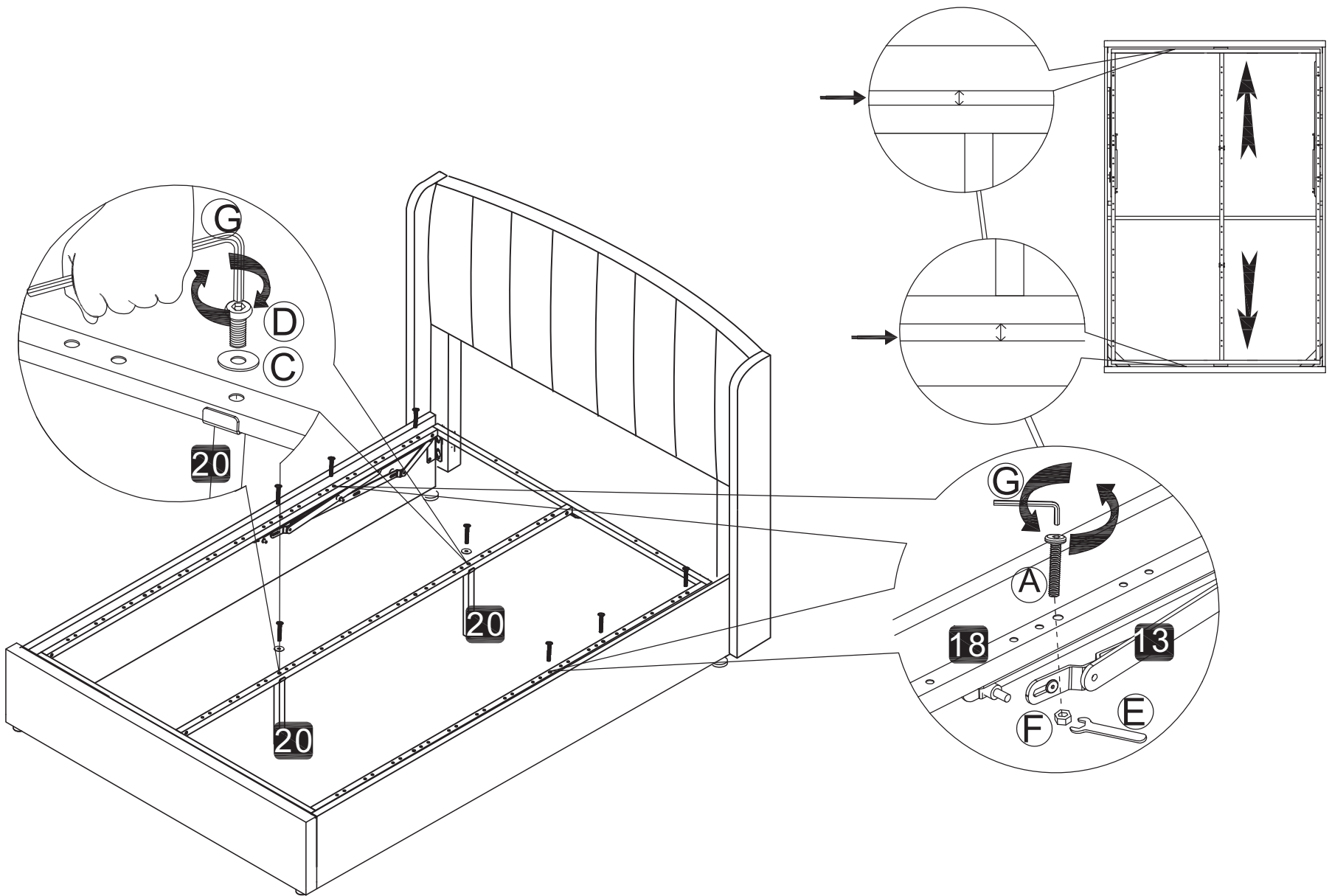

Step8:

②4  x24

②5  x12

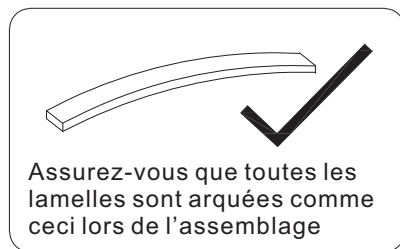
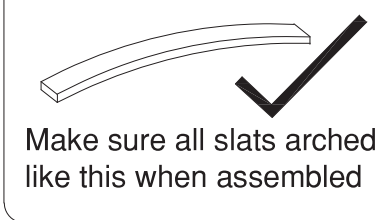
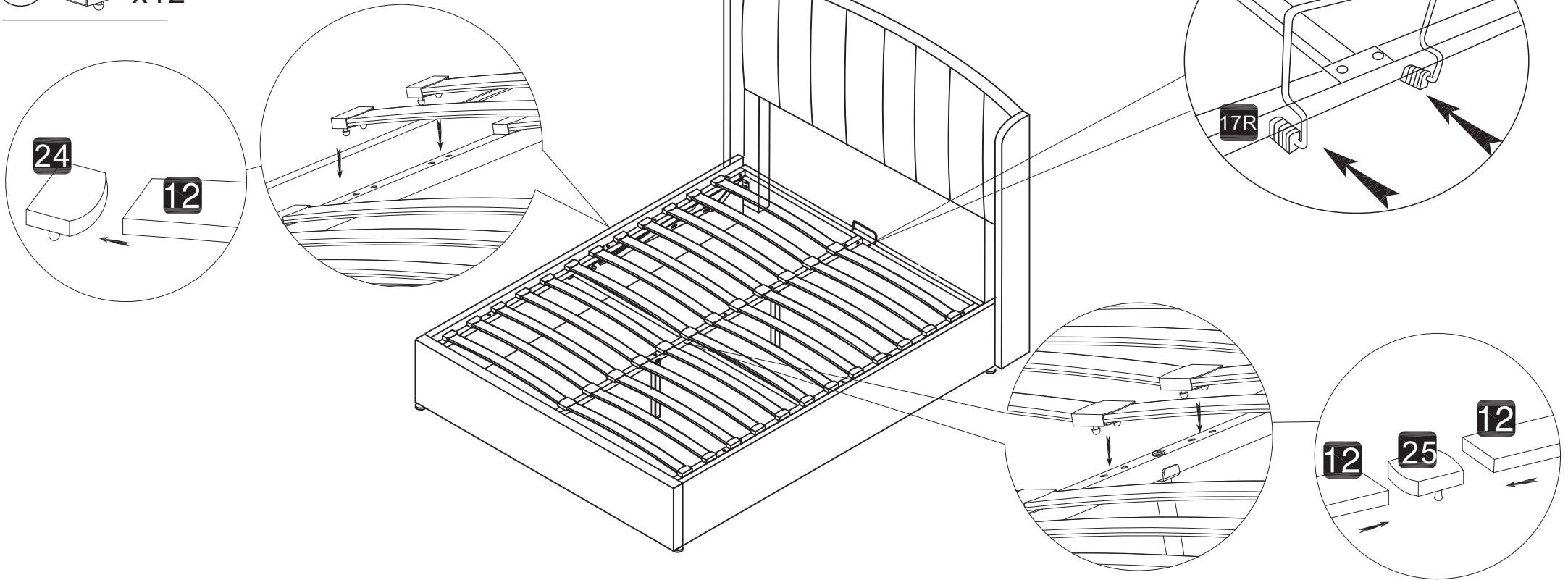

Step9:

ⓕ  ×4

ⓔ  ×1

②8  ×1

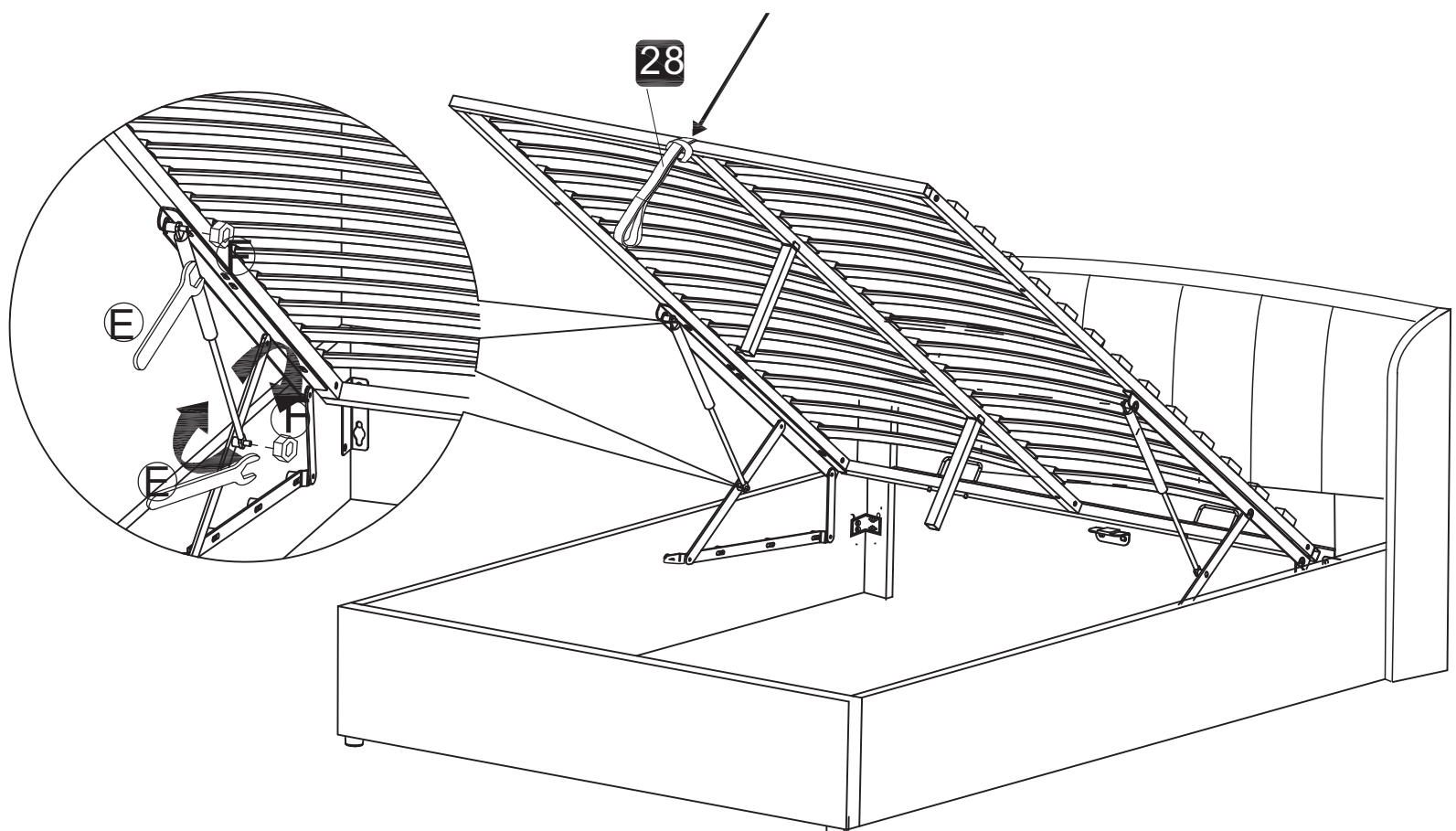

Step 10:

