











INSTRUCTION GUIDE/GEBRAUCHSANLEITUNG/NOTICE D'UTILISATION

PARTS LIST/STÜCKLISTE/PARTS LIST

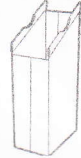
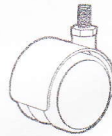
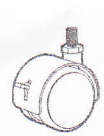
<p>A</p>  <p>2pcs</p>	<p>B</p>  <p>2pcs</p>	<p>C</p>  <p>2pcs</p>	<p>D</p>  <p>2pcs</p>	<p>E</p>  <p>4pcs</p>	<p>F</p>  <p>1pc</p>
<p>G</p>  <p>4pcs</p>	<p>H</p>  <p>2pcs</p>	<p>I</p>  <p>2pcs</p>	<p>J</p>  <p>8pcs</p>	<p>K</p>  <p>4pcs</p>	<p>L</p>  <p>4pcs</p>

ASSEMBLY/MONTAGE/ASSEMBLAGE

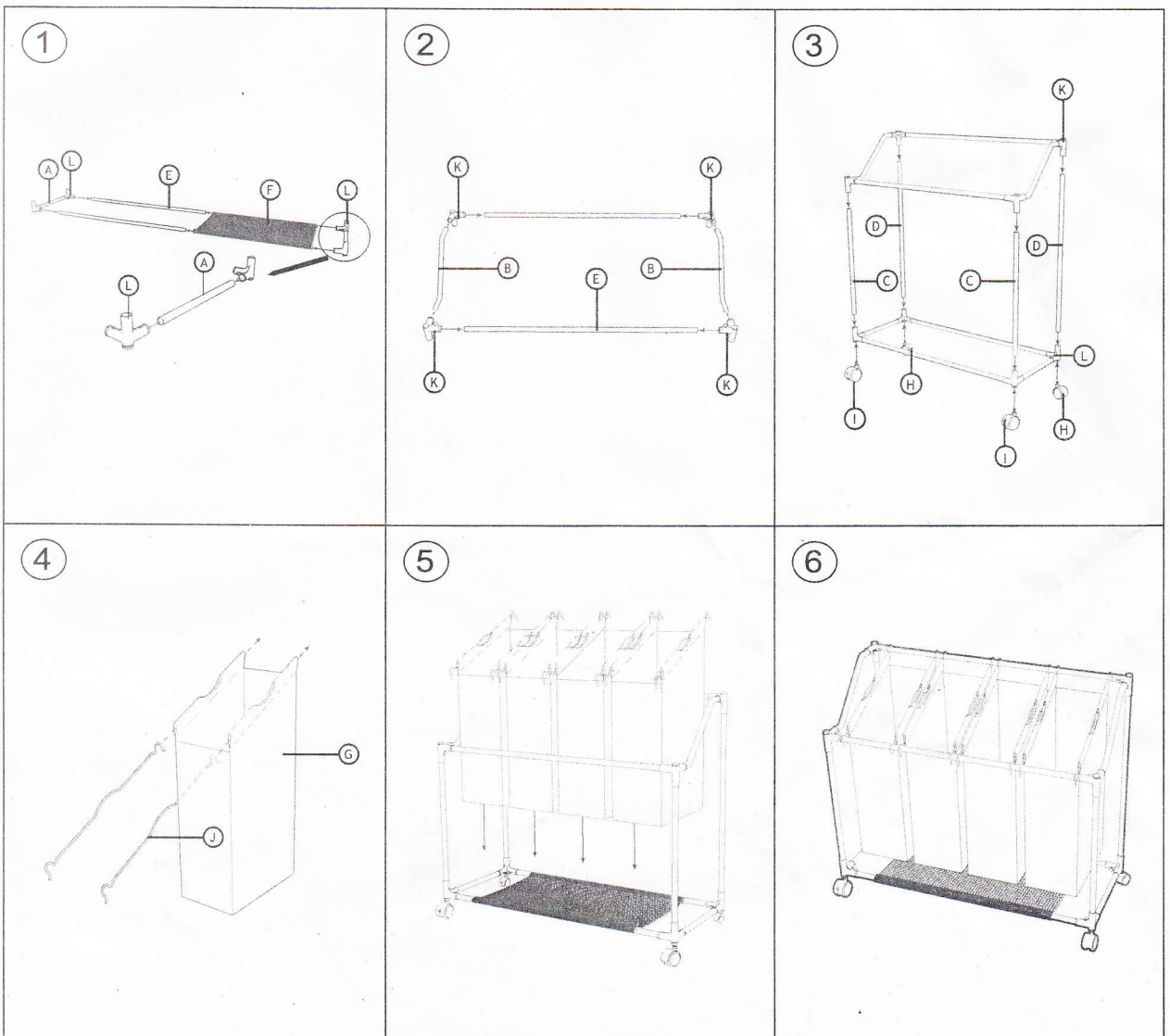

RETAIN FOR FUTURE REFERENCE
 FÜR KÜNFTIGE VERWENDUNG AUFBEWAHREN
 A CONSERVER POUR UNE UTILISATION FUTURE